

# ESP32

## Technical Reference Manual



Version 4.7  
Espressif Systems  
Copyright © 2022

## About This Manual

The **ESP32 Technical Reference Manual** is addressed to application developers. The manual provides detailed and complete information on how to use the ESP32 memory and peripherals.

For pin definition, electrical characteristics, and package information, please see [ESP32 Datasheet](#).

## Document Updates

Please always refer to the latest version at <https://www.espressif.com/en/support/download/documents>.

## Revision History

For any changes to this document over time, please refer to the [last page](#).

## Documentation Change Notification

Espressif provides email notifications to keep customers updated on changes to technical documentation. Please subscribe at [www.espressif.com/en/subscribe](http://www.espressif.com/en/subscribe).

## Certification

Download certificates for Espressif products from [www.espressif.com/en/certificates](http://www.espressif.com/en/certificates).

# Contents

<b>1</b>	<b>System and Memory</b>	<b>24</b>
1.1	Introduction	24
1.2	Features	24
1.3	Functional Description	26
1.3.1	Address Mapping	26
1.3.2	Embedded Memory	26
1.3.2.1	Internal ROM 0	27
1.3.2.2	Internal ROM 1	27
1.3.2.3	Internal SRAM 0	27
1.3.2.4	Internal SRAM 1	28
1.3.2.5	Internal SRAM 2	28
1.3.2.6	DMA	29
1.3.2.7	RTC FAST Memory	29
1.3.2.8	RTC SLOW Memory	29
1.3.3	External Memory	29
1.3.4	Cache	30
1.3.5	Peripherals	31
1.3.5.1	Asymmetric PID Controller Peripheral	32
1.3.5.2	Non-Contiguous Peripheral Memory Ranges	32
1.3.5.3	Memory Speed	33
<b>2</b>	<b>Interrupt Matrix (INTERRUPT)</b>	<b>34</b>
2.1	Overview	34
2.2	Features	34
2.3	Functional Description	34
2.3.1	Peripheral Interrupt Source	34
2.3.2	CPU Interrupt	37
2.3.3	Allocate Peripheral Interrupt Sources to Peripheral Interrupt on CPU	37
2.3.4	CPU NMI Interrupt Mask	38
2.3.5	Query Current Interrupt Status of Peripheral Interrupt Source	38
2.4	Registers	38
<b>3</b>	<b>Reset and Clock</b>	<b>39</b>
3.1	System Reset	39
3.1.1	Introduction	39
3.1.2	Reset Source	39
3.2	System Clock	40
3.2.1	Introduction	40
3.2.2	Clock Source	41
3.2.3	CPU Clock	41
3.2.4	Peripheral Clock	42
3.2.4.1	APB_CLK Source	42

3.2.4.2	REF_TICK Source	42
3.2.4.3	LEDC_SCLK Source	43
3.2.4.4	APLL_SCLK Source	43
3.2.4.5	PLL_D2_CLK Source	43
3.2.4.6	Clock Source Considerations	43
3.2.5	Wi-Fi BT Clock	43
3.2.6	RTC Clock	44
3.2.7	Audio PLL	44
<b>4</b>	<b>IO_MUX and GPIO Matrix (GPIO, IO_MUX)</b>	<b>45</b>
4.1	Overview	45
4.2	Peripheral Input via GPIO Matrix	46
4.2.1	Summary	46
4.2.2	Functional Description	46
4.2.3	Simple GPIO Input	47
4.3	Peripheral Output via GPIO Matrix	47
4.3.1	Summary	47
4.3.2	Functional Description	48
4.3.3	Simple GPIO Output	49
4.4	Direct I/O via IO_MUX	49
4.4.1	Summary	49
4.4.2	Functional Description	49
4.5	RTC IO_MUX for Low Power and Analog I/O	49
4.5.1	Summary	49
4.5.2	Functional Description	49
4.6	Light-sleep Mode Pin Functions	50
4.7	Pad Hold Feature	50
4.8	I/O Pad Power Supplies	50
4.8.1	VDD_SDIO Power Domain	52
4.9	Peripheral Signal List	52
4.10	IO_MUX Pad List	57
4.11	RTC_MUX Pin List	58
4.12	Register Summary	58
4.12.1	GPIO Matrix Register Summary	58
4.12.2	IO MUX Register Summary	60
4.12.3	RTC IO MUX Register Summary	61
4.13	Registers	62
4.13.1	GPIO Matrix Registers	62
4.13.2	IO MUX Registers	71
4.13.3	RTC IO MUX Registers	73
<b>5</b>	<b>DPort Registers</b>	<b>87</b>
5.1	Introduction	87
5.2	Features	87
5.3	Functional Description	87
5.3.1	System and Memory Register	87

5.3.2	Reset and Clock Registers	87
5.3.3	Interrupt Matrix Register	87
5.3.4	DMA Registers	87
5.3.5	MPU/MMU Registers	87
5.3.6	APP_CPU Controller Registers	88
5.3.7	Peripheral Clock Gating and Reset	88
5.4	Register Summary	89
5.5	Registers	96
<b>6</b>	<b>DMA Controller (DMA)</b>	112
6.1	Overview	112
6.2	Features	112
6.3	Functional Description	112
6.3.1	DMA Engine Architecture	112
6.3.2	Linked List	113
6.4	UART DMA (UDMA)	113
6.5	SPI DMA Interface	115
6.6	I2S DMA Interface	116
<b>7</b>	<b>SPI Controller (SPI)</b>	117
7.1	Overview	117
7.2	SPI Features	118
7.3	GP-SPI	118
7.3.1	GP-SPI Four-line Full-duplex Communication	119
7.3.2	GP-SPI Four-line Half-duplex Communication	119
7.3.3	GP-SPI Three-line Half-duplex Communication	120
7.3.4	GP-SPI Data Buffer	120
7.4	GP-SPI Clock Control	121
7.4.1	GP-SPI Clock Polarity (CPOL) and Clock Phase (CPHA)	121
7.4.2	GP-SPI Timing	122
7.5	Parallel QSPI	123
7.5.1	Communication Format of Parallel QSPI	123
7.6	GP-SPI Interrupt Hardware	124
7.6.1	SPI Interrupts	124
7.6.2	DMA Interrupts	124
7.7	Register Summary	125
7.8	Registers	128
<b>8</b>	<b>SDIO Slave Controller</b>	151
8.1	Overview	151
8.2	Features	151
8.3	Functional Description	151
8.3.1	SDIO Slave Block Diagram	151
8.3.2	Sending and Receiving Data on SDIO Bus	152
8.3.3	Register Access	152
8.3.4	DMA	152

8.3.5	Packet-Sending/-Receiving Procedure	153
8.3.5.1	Sending Packets to SDIO Host	154
8.3.5.2	Receiving Packets from SDIO Host	155
8.3.6	SDIO Bus Timing	156
8.3.7	Interrupt	157
8.3.7.1	Host Interrupt	157
8.3.7.2	Slave Interrupt	157
8.4	Register Summary	158
8.5	SLC Registers	160
8.6	SLC Host Registers	168
8.7	HINF Registers	182
<b>9</b>	<b>SD/MMC Host Controller</b>	<b>183</b>
9.1	Overview	183
9.2	Features	183
9.3	SD/MMC External Interface Signals	183
9.4	Functional Description	184
9.4.1	SD/MMC Host Controller Architecture	184
9.4.1.1	BIU	185
9.4.1.2	CIU	185
9.4.2	Command Path	185
9.4.3	Data Path	186
9.4.3.1	Data Transmit Operation	186
9.4.3.2	Data Receive Operation	187
9.5	Software Restrictions for Proper CIU Operation	187
9.6	RAM for Receiving and Sending Data	188
9.6.1	Transmit RAM Module	188
9.6.2	Receive RAM Module	188
9.7	Descriptor Chain	189
9.8	The Structure of a Linked List	189
9.9	Initialization	191
9.9.1	DMAC Initialization	191
9.9.2	DMAC Transmission Initialization	191
9.9.3	DMAC Reception Initialization	192
9.10	Clock Phase Selection	193
9.11	Interrupt	193
9.12	Register Summary	193
9.13	Registers	195
<b>10</b>	<b>Ethernet Media Access Controller (MAC)</b>	<b>213</b>
10.1	Overview	213
10.2	EMAC_CORE	215
10.2.1	Transmit Operation	215
10.2.1.1	Transmit Flow Control	216
10.2.1.2	Retransmission During a Collision	216
10.2.2	Receive Operation	216

10.2.2.1	Reception Protocol	217
10.2.2.2	Receive Frame Controller	217
10.2.2.3	Receive Flow Control	217
10.2.2.4	Reception of Multiple Frames	218
10.2.2.5	Error Handling	218
10.2.2.6	Receive Status Word	218
10.3	MAC Interrupt Controller	218
10.4	MAC Address Filtering	219
10.4.1	Unicast Destination Address Filtering	219
10.4.2	Multicast Destination Address Filtering	219
10.4.3	Broadcast Address Filtering	219
10.4.4	Unicast Source Address Filtering	219
10.4.5	Inverse Filtering Operation	219
10.4.6	Good Transmitted Frames and Received Frames	221
10.5	EMAC_MTL (MAC Transaction Layer)	221
10.6	PHY Interface	221
10.6.1	MII (Media Independent Interface)	222
10.6.1.1	Interface Signals Between MII and PHY	222
10.6.1.2	MII Clock	223
10.6.2	RMII (Reduced Media-Independent Interface)	224
10.6.2.1	RMII Interface Signal Description	224
10.6.2.2	RMII Clock	224
10.6.3	Station Management Agent (SMA) Interface	225
10.6.4	RMII Timing	225
10.7	Ethernet DMA Features	226
10.8	Linked List Descriptors	226
10.8.1	Transmit Descriptors	226
10.8.2	Receive Descriptors	232
10.9	Register Summary	237
10.10	Registers	240
<b>11</b>	<b>I2C Controller (I2C)</b>	<b>278</b>
11.1	Overview	278
11.2	Features	278
11.3	Functional Description	278
11.3.1	Introduction	278
11.3.2	Architecture	279
11.3.3	I2C Bus Timing	280
11.3.4	I2C cmd Structure	281
11.3.5	I2C Master Writes to Slave	282
11.3.6	Master Reads from Slave	286
11.3.7	Interrupts	288
11.4	Register Summary	289
11.5	Registers	291
<b>12</b>	<b>I2S Controller (I2S)</b>	<b>302</b>

12.1	Overview	302
12.2	Features	303
12.3	The Clock of I2S Module	304
12.4	I2S Mode	305
12.4.1	Supported Audio Standards	305
12.4.1.1	Philips Standard	305
12.4.1.2	MSB Alignment Standard	305
12.4.1.3	PCM Standard	306
12.4.2	Module Reset	306
12.4.3	FIFO Operation	306
12.4.4	Sending Data	307
12.4.5	Receiving Data	308
12.4.6	I2S Master/Slave Mode	310
12.4.7	I2S PDM	310
12.5	Camera-LCD Controller	312
12.5.1	LCD Master Transmitting Mode	312
12.5.2	Camera Slave Receiving Mode	313
12.5.3	ADC/DAC mode	314
12.6	I2S Interrupts	315
12.6.1	FIFO Interrupts	315
12.6.2	DMA Interrupts	315
12.7	Register Summary	315
12.8	Registers	318
<b>13</b>	<b>UART Controller (UART)</b>	<b>336</b>
13.1	Overview	336
13.2	UART Features	336
13.3	Functional Description	336
13.3.1	Introduction	336
13.3.2	UART Architecture	337
13.3.3	UART RAM	338
13.3.4	Baud Rate Detection	339
13.3.5	UART Data Frame	339
13.3.6	Flow Control	340
13.3.6.1	Hardware Flow Control	340
13.3.6.2	Software Flow Control	341
13.3.7	UART DMA	341
13.3.8	UART Interrupts	341
13.3.9	UHCI Interrupts	342
13.4	Register Summary	343
13.4.1	UART Registers	343
13.4.2	UHCI Registers	344
13.5	Registers	346
<b>14</b>	<b>LED PWM Controller (LEDC)</b>	<b>378</b>
14.1	Introduction	378



14.2	Functional Description	378
14.2.1	Architecture	378
14.2.2	Timers	379
14.2.3	Channels	381
14.2.4	Interrupts	382
14.3	Register Summary	382
14.4	Registers	385
<b>15</b>	<b>Remote Control Peripheral (RMT)</b>	<b>395</b>
15.1	Introduction	395
15.2	Functional Description	395
15.2.1	RMT Architecture	395
15.2.2	RMT RAM	396
15.2.3	Clock	396
15.2.4	Transmitter	396
15.2.5	Receiver	397
15.2.6	Interrupts	397
15.3	Register Summary	397
15.4	Registers	398
<b>16</b>	<b>Motor Control PWM (PWM)</b>	<b>404</b>
16.1	Introduction	404
16.2	Features	404
16.3	Submodules	406
16.3.1	Overview	406
16.3.1.1	Prescaler Submodule	406
16.3.1.2	Timer Submodule	406
16.3.1.3	Operator Submodule	407
16.3.1.4	Fault Detection Submodule	409
16.3.1.5	Capture Submodule	409
16.3.2	PWM Timer Submodule	409
16.3.2.1	Configurations of the PWM Timer Submodule	409
16.3.2.2	PWM Timer's Working Modes and Timing Event Generation	410
16.3.2.3	PWM Timer Shadow Register	414
16.3.2.4	PWM Timer Synchronization and Phase Locking	414
16.3.3	PWM Operator Submodule	414
16.3.3.1	PWM Generator Submodule	416
16.3.3.2	Dead Time Generator Submodule	426
16.3.3.3	PWM Carrier Submodule	431
16.3.3.4	Fault Handler Submodule	434
16.3.4	Capture Submodule	435
16.3.4.1	Introduction	435
16.3.4.2	Capture Timer	436
16.3.4.3	Capture Channel	436
16.4	Register Summary	437
16.5	Registers	439

<b>17 Pulse Count Controller (PCNT)</b>	486
17.1 Overview	486
17.2 Functional Description	486
17.2.1 Architecture	486
17.2.2 Counter Channel Inputs	487
17.2.3 Watchpoints	487
17.2.4 Examples	488
17.2.5 Interrupts	488
17.3 Register Summary	489
17.4 Registers	491
<b>18 Timer Group (TIMG)</b>	496
18.1 Introduction	496
18.2 Functional Description	496
18.2.1 16-bit Prescaler	496
18.2.2 64-bit Time-base Counter	496
18.2.3 Alarm Generation	497
18.2.4 MWDT	497
18.2.5 Interrupts	497
18.3 Register Summary	497
18.4 Registers	499
<b>19 Watchdog Timers (WDT)</b>	507
19.1 Introduction	507
19.2 Features	507
19.3 Functional Description	507
19.3.1 Clock	507
19.3.1.1 Operating Procedure	507
19.3.1.2 Write Protection	508
19.3.1.3 Flash Boot Protection	508
19.3.1.4 Registers	508
<b>20 eFuse Controller</b>	509
20.1 Introduction	509
20.2 Features	509
20.3 Functional Description	509
20.3.1 Structure	509
20.3.1.1 System Parameter efuse_wr_disable	511
20.3.1.2 System Parameter efuse_rd_disable	511
20.3.1.3 System Parameter coding_scheme	511
20.3.1.4 BLK3_part_reserve	512
20.3.2 Programming of System Parameters	513
20.3.3 Software Reading of System Parameters	515
20.3.4 The Use of System Parameters by Hardware Modules	517
20.3.5 Interrupts	517
20.4 Register Summary	517

20.5	Registers	520
<b>21</b>	<b>Two-wire Automotive Interface (TWAI)</b>	<b>531</b>
21.1	Overview	531
21.2	Features	531
21.3	Functional Protocol	531
21.3.1	TWAI Properties	531
21.3.2	TWAI Messages	532
21.3.2.1	Data Frames and Remote Frames	533
21.3.2.2	Error and Overload Frames	535
21.3.2.3	Interframe Space	536
21.3.3	TWAI Errors	537
21.3.3.1	Error Types	537
21.3.3.2	Error States	537
21.3.3.3	Error Counters	538
21.3.4	TWAI Bit Timing	539
21.3.4.1	Nominal Bit	539
21.3.4.2	Hard Synchronization and Resynchronization	540
21.4	Architectural Overview	540
21.4.1	Registers Block	540
21.4.2	Bit Stream Processor	542
21.4.3	Error Management Logic	542
21.4.4	Bit Timing Logic	542
21.4.5	Acceptance Filter	542
21.4.6	Receive FIFO	542
21.5	Functional Description	542
21.5.1	Modes	543
21.5.1.1	Reset Mode	543
21.5.1.2	Operation Mode	543
21.5.2	Bit Timing	543
21.5.3	Interrupt Management	544
21.5.3.1	Receive Interrupt (RXI)	544
21.5.3.2	Transmit Interrupt (TXI)	545
21.5.3.3	Error Warning Interrupt (EWI)	545
21.5.3.4	Data Overrun Interrupt (DOI)	545
21.5.3.5	Error Passive Interrupt (TXI)	546
21.5.3.6	Arbitration Lost Interrupt (ALI)	546
21.5.3.7	Bus Error Interrupt (BEI)	546
21.5.4	Transmit and Receive Buffers	546
21.5.4.1	Overview of Buffers	546
21.5.4.2	Frame Information	547
21.5.4.3	Frame Identifier	547
21.5.4.4	Frame Data	548
21.5.5	Receive FIFO and Data Overruns	548
21.5.6	Acceptance Filter	549
21.5.6.1	Single Filter Mode	549

21.5.6.2	Dual Filter Mode	550
21.5.7	Error Management	550
21.5.7.1	Error Warning Limit	551
21.5.7.2	Error Passive	552
21.5.7.3	Bus-Off and Bus-Off Recovery	552
21.5.8	Error Code Capture	553
21.5.9	Arbitration Lost Capture	554
21.6	Register Summary	554
21.7	Registers	556
<b>22</b>	<b>AES Accelerator (AES)</b>	<b>569</b>
22.1	Introduction	569
22.2	Features	569
22.3	Functional Description	569
22.3.1	AES Algorithm Operations	569
22.3.2	Key, Plaintext and Ciphertext	569
22.3.3	Endianness	569
22.3.4	Encryption and Decryption Operations	572
22.3.5	Speed	572
22.4	Register Summary	572
22.5	Registers	573
<b>23</b>	<b>SHA Accelerator (SHA)</b>	<b>575</b>
23.1	Introduction	575
23.2	Features	575
23.3	Functional Description	575
23.3.1	Padding and Parsing the Message	575
23.3.2	Message Digest	575
23.3.3	Hash Operation	575
23.3.4	Speed	576
23.4	Register Summary	576
23.5	Registers	578
<b>24</b>	<b>RSA Accelerator (RSA)</b>	<b>584</b>
24.1	Introduction	584
24.2	Features	584
24.3	Functional Description	584
24.3.1	Initialization	584
24.3.2	Large Number Modular Exponentiation	584
24.3.3	Large Number Modular Multiplication	586
24.3.4	Large Number Multiplication	586
24.4	Register Summary	587
24.5	Registers	588
<b>25</b>	<b>Random Number Generator (RNG)</b>	<b>590</b>
25.1	Introduction	590

25.2	Feature	590
25.3	Functional Description	590
25.4	Programming Procedure	591
25.5	Register Summary	591
25.6	Register	591
<b>26</b>	<b>External Memory Encryption and Decryption (FLASH)</b>	592
26.1	Overview	592
26.2	Features	592
26.3	Functional Description	592
26.3.1	Key Generator	593
26.3.2	Flash Encryption Block	593
26.3.3	Flash Decryption Block	594
26.4	Register Summary	594
26.5	Register	596
<b>27</b>	<b>Memory Management and Protection Units (MMU, MPU)</b>	597
27.1	Introduction	597
27.2	Features	597
27.3	Functional Description	597
27.3.1	PID Controller	597
27.3.2	MPU/MMU	597
27.3.2.1	Embedded Memory	598
27.3.2.2	External Memory	604
27.3.2.3	Peripheral	610
<b>28</b>	<b>Process ID Controller (PID)</b>	612
28.1	Overview	612
28.2	Features	612
28.3	Functional Description	612
28.3.1	Interrupt Identification	612
28.3.2	Information Recording	613
28.3.3	Proactive Process Switching	614
28.4	Register Summary	616
28.5	Registers	617
<b>29</b>	<b>On-Chip Sensors and Analog Signal Processing</b>	621
29.1	Introduction	621
29.2	Capacitive Touch Sensor	621
29.2.1	Introduction	621
29.2.2	Features	621
29.2.3	Available GPIOs	622
29.2.4	Functional Description	622
29.2.5	Touch FSM	623
29.3	SAR ADC	623
29.3.1	Introduction	623

29.3.2	Features	625
29.3.3	Outline of Function	625
29.3.4	RTC SAR ADC Controllers	626
29.3.5	DIG SAR ADC Controllers	627
29.4	Hall Sensor	629
29.4.1	Introduction	629
29.4.2	Features	629
29.4.3	Functional Description	629
29.5	DAC	630
29.5.1	Introduction	630
29.5.2	Features	630
29.5.3	Structure	631
29.5.4	Cosine Waveform Generator	631
29.5.5	DMA support	632
29.6	Register Summary	633
29.6.1	Sensors	633
29.6.2	Advanced Peripheral Bus	633
29.6.3	RTC I/O	634
29.7	Registers	635
29.7.1	Sensors	635
29.7.2	Advanced Peripheral Bus	645
29.7.3	RTC I/O	648
<b>30</b>	<b>ULP Coprocessor (ULP)</b>	<b>649</b>
30.1	Introduction	649
30.2	Features	649
30.3	Functional Description	650
30.4	Instruction Set	650
30.4.1	ALU - Perform Arithmetic/Logic Operations	650
30.4.1.1	Operations Among Registers	651
30.4.1.2	Operations with Immediate Value	652
30.4.1.3	Operations with Stage Count Register	652
30.4.2	ST – Store Data in Memory	653
30.4.3	LD – Load Data from Memory	653
30.4.4	JUMP – Jump to an Absolute Address	654
30.4.5	JUMPR – Jump to a Relative Offset (Conditional upon R0)	654
30.4.6	JUMPS – Jump to a Relative Address (Conditional upon Stage Count Register)	655
30.4.7	HALT – End the Program	655
30.4.8	WAKE – Wake up the Chip	656
30.4.9	Sleep – Set the ULP Timer’s Wake-up Period	656
30.4.10	WAIT – Wait for a Number of Cycles	656
30.4.11	ADC – Take Measurement with ADC	657
30.4.12	I2C_RD/I2C_WR – Read/Write I <sup>2</sup> C	657
30.4.13	REG_RD – Read from Peripheral Register	658
30.4.14	REG_WR – Write to Peripheral Register	659
30.5	ULP Program Execution	659

30.6	RTC_I2C Controller	661
30.6.1	Configuring RTC_I2C	661
30.6.2	Using RTC_I2C	662
30.6.2.1	I2C_RD - Read a Single Byte	662
30.6.2.2	I2C_WR - Write a Single Byte	662
30.6.2.3	Detecting Error Conditions	663
30.6.2.4	Connecting I <sup>2</sup> C Signals	663
30.7	Register Summary	663
30.7.1	SENS_ULP Address Space	663
30.7.2	RTC_I2C Address Space	664
30.8	Registers	665
30.8.1	SENS_ULP Address Space	665
30.8.2	RTC_I2C Address Space	667
<b>31</b>	<b>Low-Power Management (RTC_CNTL)</b>	<b>673</b>
31.1	Introduction	673
31.2	Features	673
31.3	Functional Description	673
31.3.1	Overview	674
31.3.2	Digital Core Voltage Regulator	674
31.3.3	Low-Power Voltage Regulator	674
31.3.4	Flash Voltage Regulator	675
31.3.5	Brownout Detector	676
31.3.6	RTC Module	676
31.3.7	Low-Power Clocks	678
31.3.8	Power-Gating Implementation	679
31.3.9	Predefined Power Modes	680
31.3.10	Wakeup Source	681
31.3.11	RTC Timer	682
31.3.12	RTC Boot	682
31.4	Register Summary	683
31.5	Registers	686
	<b>Glossary</b>	<b>712</b>
	Abbreviations for Peripherals	712
	Abbreviations for Registers	712
	<b>Revision History</b>	<b>713</b>

## List of Tables

1-1	Address Mapping	26
1-2	Embedded Memory Address Mapping	27
1-3	Module with DMA	29
1-4	External Memory Address Mapping	29
1-5	Cache memory mode	30
1-6	Peripheral Address Mapping	31
2-1	PRO_CPU, APP_CPU Interrupt Configuration	35
2-2	CPU Interrupts	37
3-1	PRO_CPU and APP_CPU Reset Reason Values	39
3-2	CPU_CLK Source	41
3-3	CPU_CLK Derivation	41
3-4	Peripheral Clock Usage	42
3-5	APB_CLK Derivation	42
3-6	REF_TICK Derivation	43
3-7	LEDC_SCLK Derivation	43
4-1	IO_MUX Light-sleep Pin Function Registers	50
4-2	GPIO Matrix Peripheral Signals	52
4-3	IO_MUX Pad Summary	57
4-4	RTC_MUX Pin Summary	58
7-1	Mapping Between SPI Bus Signals and Pin Function Signals	117
7-2	Command Definitions Supported by GP-SPI Slave in Half-duplex Mode	119
7-3	Clock Polarity and Phase, and Corresponding SPI Register Values for SPI Master	121
7-4	Clock Polarity and Phase, and Corresponding SPI Register Values for SPI Slave	121
9-1	SD/MMC Signal Description	184
9-2	DES0	189
9-3	DES1	190
9-4	DES2	191
9-5	DES3	191
10-1	Destination Address Filtering	220
10-2	Source Address Filtering	220
10-3	Timing Parameters - Receiving Data	225
10-4	Timing Parameters – Transmitting Data	226
10-5	Transmit Descriptor 0 (TDES0)	227
10-6	Transmit Descriptor 1 (TDES1)	231
10-7	Transmit Descriptor 2 (TDES2)	231
10-8	Transmit Descriptor 3 (TDES3)	231
10-9	Transmit Descriptor 6 (TDES6)	231
10-10	Transmit Descriptor 7 (TDES7)	232
10-11	Receive Descriptor 0 (RDES0)	232
10-12	Receive Descriptor 1 (RDES1)	235
10-13	Receive Descriptor 2 (RDES2)	235
10-14	Receive Descriptor 3 (RDES3)	235
10-15	Receive Descriptor 4 (RDES4)	236



10-16	Receive Descriptor 6 (RDES6)	237
10-17	Receive Descriptor 7 (RDES7)	237
11-1	SCL Frequency Configuration	280
12-1	I2S Signal Bus Description	303
12-2	Register Configuration	307
12-3	Send Channel Mode	307
12-4	Modes of Writing Received Data into FIFO and the Corresponding Register Configuration	309
12-5	The Register Configuration to Which the Four Modes Correspond	309
12-6	Upsampling Rate Configuration	311
12-7	Down-sampling Configuration	312
14-1	Commonly-used Frequencies and Resolutions	379
16-1	Configuration Parameters of the Operator Submodule	408
16-2	Timing Events Used in PWM Generator	416
16-3	Timing Events Priority When PWM Timer Increments	417
16-4	Timing Events Priority when PWM Timer Decrements	417
16-5	Dead Time Generator Switches Control Registers	427
16-6	Typical Dead Time Generator Operating Modes	428
20-1	System Parameters	509
20-2	BLOCK1/2/3 Encoding	512
20-3	Program Registers	513
20-4	Timing Configuration	515
20-5	Software Read Registers	516
21-1	Data Frames and Remote Frames in SFF and EFF	534
21-2	Error Frame	535
21-3	Overload Frame	536
21-4	Interframe Space	536
21-5	Segments of a Nominal Bit Time	539
21-6	Bit Information of TWAI_CLOCK_DIVIDER_REG; TWAI Address 0x18	543
21-7	Bit Information of TWAI_BUS_TIMING_1_REG; TWAI Address 0x1c	544
21-8	Buffer Layout for Standard Frame Format and Extended Frame Format	546
21-9	TX/RX Frame Information (SFF/EFF) TWAI Address 0x40	547
21-10	TX/RX Identifier 1 (SFF); TWAI Address 0x44	547
21-11	TX/RX Identifier 2 (SFF); TWAI Address 0x48	548
21-12	TX/RX Identifier 1 (EFF); TWAI Address 0x44	548
21-13	TX/RX Identifier 2 (EFF); TWAI Address 0x48	548
21-14	TX/RX Identifier 3 (EFF); TWAI Address 0x4c	548
21-15	TX/RX Identifier 4 (EFF); TWAI Address 0x50	548
21-16	Bit Information of TWAI_ERR_CODE_CAP_REG; TWAI Address 0x30	553
21-17	Bit Information of Bits SEG.4 - SEG.0	553
21-18	Bit Information of TWAI_ARB_LOST_CAP_REG; TWAI Address 0x2c	554
22-1	Operation Mode	569
22-2	AES Text Endianness	570
22-3	AES-128 Key Endianness	571
22-4	AES-192 Key Endianness	571
22-5	AES-256 Key Endianness	571
27-1	MPU and MMU Structure for Internal Memory	598

27-2	MPU for RTC FAST Memory	599
27-3	MPU for RTC SLOW Memory	599
27-4	Page Mode of MMU for the Remaining 128 KB of Internal SRAM0 and SRAM2	600
27-5	Page Boundaries for SRAM0 MMU	601
27-6	Page Boundaries for SRAM2 MMU	601
27-7	DPORT_DMMU_TABLE $n$ _REG & DPORT_IMMU_TABLE $n$ _REG	602
27-8	MPU for DMA	603
27-9	Virtual Address for External Memory	605
27-10	MMU Entry Numbers for PRO_CPU	605
27-11	MMU Entry Numbers for APP_CPU	605
27-12	MMU Entry Numbers for PRO_CPU (Special Mode)	606
27-13	MMU Entry Numbers for APP_CPU (Special Mode)	606
27-14	Virtual Address Mode for External SRAM	607
27-15	Virtual Address for External SRAM ( Normal Mode )	608
27-16	Virtual Address for External SRAM ( Low-High Mode )	608
27-17	Virtual Address for External SRAM (Even-Odd Mode)	608
27-18	MMU Entry Numbers for External RAM	609
27-19	MPU for Peripheral	610
27-20	DPORT_AHBLITE_MPU_TABLE_X_REG	611
28-1	Interrupt Vector Entry Address	613
28-2	Configuration of PIDCTRL_LEVEL_REG	613
28-3	Configuration of PIDCTRL_FROM $n$ _REG	614
29-1	ESP32 Capacitive Sensing Touch Pads	622
29-2	Inputs of SAR ADC module	625
29-3	ESP32 SAR ADC Controllers	626
29-4	Fields of the Pattern Table Register	628
29-5	Fields of Type I DMA Data Format	629
29-6	Fields of Type II DMA Data Format	629
30-1	ALU Operations Among Registers	651
30-2	ALU Operations with Immediate Value	652
30-3	ALU Operations with Stage Count Register	653
30-4	Input Signals Measured Using the ADC Instruction	657
31-1	RTC Power Domains	679
31-2	Wake-up Source	681

## List of Figures

1-1	System Structure	25
1-2	System Address Mapping	25
1-3	Cache Block Diagram	30
2-1	Interrupt Matrix Structure	34
3-1	System Reset	39
3-2	System Clock	40
4-1	IO_MUX, RTC IO_MUX and GPIO Matrix Overview	45
4-2	Peripheral Input via IO_MUX, GPIO Matrix	46
4-3	Output via GPIO Matrix	48
4-4	ESP32 I/O Pad Power Sources (QFN 6*6, Top View)	51
4-5	ESP32 I/O Pad Power Sources (QFN 5*5, Top View)	51
6-1	DMA Engine Architecture	112
6-2	Linked List Structure	113
6-3	Data Transfer in UDMA Mode	114
6-4	SPI DMA	115
7-1	SPI Architecture	117
7-2	SPI Master and Slave Full-duplex/Half-duplex Communication	118
7-3	SPI Data Buffer	120
7-4	GP-SPI	123
7-5	Parallel QSPI	123
7-6	Communication Format of Parallel QSPI	124
8-1	SDIO Slave Block Diagram	151
8-2	SDIO Bus Packet Transmission	152
8-3	CMD53 Content	152
8-4	SDIO Slave DMA Linked List Structure	153
8-5	SDIO Slave Linked List	153
8-6	Packet Sending Procedure (Initiated by Slave)	154
8-7	Packet Receiving Procedure (Initiated by Host)	155
8-8	Loading Receiving Buffer	156
8-9	Sampling Timing Diagram	156
8-10	Output Timing Diagram	157
9-1	SD/MMC Controller Topology	183
9-2	SD/MMC Controller External Interface Signals	184
9-3	SDIO Host Block Diagram	184
9-4	Command Path State Machine	186
9-5	Data Transmit State Machine	186
9-6	Data Receive State Machine	187
9-7	Descriptor Chain	189
9-8	The Structure of a Linked List	189
9-9	Clock Phase Selection	193
10-1	Ethernet MAC Functionality Overview	213
10-2	Ethernet Block Diagram	215
10-3	MII Interface	222

10-4	MII Clock	223
10-5	RMII Interface	224
10-6	RMII Clock	225
10-7	RMII Timing - Receiving Data	225
10-8	RMII Timing – Transmitting Data	226
10-9	Transmit Descriptor	226
10-10	Receive Descriptor	232
11-1	I2C Master Architecture	279
11-2	I2C Slave Architecture	279
11-3	I2C Sequence Chart	280
11-4	Structure of The I2C Command Register	281
11-5	I2C Master Writes to Slave with 7-bit Address	282
11-6	I2C Master Writes to Slave with 10-bit Address	283
11-7	I2C Master Writes to addrM in RAM of Slave with 7-bit Address	284
11-8	Master Writes to Slave with 7-bit Address in Three Segments	285
11-9	Master Reads from Slave with 7-bit Address	286
11-10	Master Reads from Slave with 10-bit Address	287
11-11	Master Reads N Bytes of Data from addrM in Slave with 7-bit Address	287
11-12	Master Reads from Slave with 7-bit Address in Three Segments	288
12-1	I2S System Block Diagram	302
12-2	I2S Clock	304
12-3	Philips Standard	305
12-4	MSB Alignment Standard	305
12-5	PCM Standard	306
12-6	Tx FIFO Data Mode	307
12-7	The First Stage of Receiving Data	308
12-8	Modes of Writing Received Data into FIFO	309
12-9	PDM Transmitting Module	310
12-10	PDM Sends Signal	311
12-11	PDM Receives Signal	311
12-12	PDM Receive Module	311
12-13	LCD Master Transmitting Mode	312
12-14	LCD Master Transmitting Data Frame, Form 1	313
12-15	LCD Master Transmitting Data Frame, Form 2	313
12-16	Camera Slave Receiving Mode	313
12-17	ADC Interface of I2S0	314
12-18	DAC Interface of I2S	314
12-19	Data Input by I2S DAC Interface	314
13-1	UART Basic Structure	337
13-2	UART Shared RAM	338
13-3	UART Data Frame Structure	339
13-4	AT_CMD Character Format	339
13-5	Hardware Flow Control	340
14-1	LED_PWM Architecture	378
14-2	LED_PWM High-speed Channel Diagram	378
14-3	LED_PWM Divider	379

14-4	LED PWM Output Signal Diagram	381
14-5	Output Signal Diagram of Fading Duty Cycle	381
15-1	RMT Architecture	395
15-2	Data Structure	396
16-1	MCPWM Module Overview	404
16-2	Prescaler Submodule	406
16-3	Timer Submodule	406
16-4	Operator Submodule	407
16-5	Fault Detection Submodule	409
16-6	Capture Submodule	409
16-7	Count-Up Mode Waveform	410
16-8	Count-Down Mode Waveforms	411
16-9	Count-Up-Down Mode Waveforms, Count-Down at Synchronization Event	411
16-10	Count-Up-Down Mode Waveforms, Count-Up at Synchronization Event	411
16-11	UTEZ and UTEP Generation in Count-Up Mode	412
16-12	DTEZ and DTEP Generation in Count-Down Mode	413
16-13	DTEP and UTEZ Generation in Count-Up-Down Mode	413
16-14	Submodules Inside the PWM Operator	415
16-15	Symmetrical Waveform in Count-Up-Down Mode	419
16-16	Count-Up, Single Edge Asymmetric Waveform, with Independent Modulation on PWMxA and PWMxB — Active High	420
16-17	Count-Up, Pulse Placement Asymmetric Waveform with Independent Modulation on PWMxA	421
16-18	Count-Up-Down, Dual Edge Symmetric Waveform, with Independent Modulation on PWMxA and PWMxB — Active High	422
16-19	Count-Up-Down, Dual Edge Symmetric Waveform, with Independent Modulation on PWMxA and PWMxB — Complementary	423
16-20	Example of an NCI Software-Force Event on PWMxA	424
16-21	Example of a CNTU Software-Force Event on PWMxB	425
16-22	Options for Setting up the Dead Time Generator Submodule	427
16-23	Active High Complementary (AHC) Dead Time Waveforms	428
16-24	Active Low Complementary (ALC) Dead Time Waveforms	429
16-25	Active High (AH) Dead Time Waveforms	429
16-26	Active Low (AL) Dead Time Waveforms	430
16-27	Example of Waveforms Showing PWM Carrier Action	432
16-28	Example of the First Pulse and the Subsequent Sustaining Pulses of the PWM Carrier Submodule	433
16-29	Possible Duty Cycle Settings for Sustaining Pulses in the PWM Carrier Submodule	434
17-1	PULSE_CNT Architecture	486
17-2	PULSE_CNT Upcounting Diagram	488
17-3	PULSE_CNT Downcounting Diagram	488
21-1	The bit fields of Data Frames and Remote Frames	533
21-2	Various Fields of an Error Frame	535
21-3	The Bit Fields of an Overload Frame	536
21-4	The Fields within an Interframe Space	538
21-5	Layout of a Bit	539
21-6	TWAI Overview Diagram	541
21-7	Acceptance Filter	549

21-8	Single Filter Mode	550
21-9	Dual Filter Mode	551
21-10	Error State Transition	552
21-11	Positions of Arbitration Lost Bits	554
25-1	Noise Source	590
26-1	Flash Encryption/Decryption Module Architecture	592
27-1	MMU Access Example	600
28-1	Interrupt Nesting	615
29-1	Touch Sensor	621
29-2	Touch Sensor Structure	622
29-3	Touch Sensor Operating Flow	623
29-4	Touch FSM Structure	624
29-5	SAR ADC Depiction	624
29-6	SAR ADC Outline of Function	625
29-7	RTC SAR ADC Outline of Function	627
29-8	Diagram of DIG SAR ADC Controllers	628
29-9	Hall Sensor	630
29-10	Diagram of DAC Function	631
29-11	Cosine Waveform (CW) Generator	632
30-1	ULP Coprocessor Diagram	649
30-2	The ULP Coprocessor Instruction Format	650
30-3	Instruction Type — ALU for Operations Among Registers	651
30-4	Instruction Type — ALU for Operations with Immediate Value	652
30-5	Instruction Type — ALU for Operations with Stage Count Register	652
30-6	Instruction Type — ST	653
30-7	Instruction Type — LD	653
30-8	Instruction Type — JUMP	654
30-9	Instruction Type — JUMPR	654
30-10	Instruction Type — JUMP	655
30-11	Instruction Type — HALT	655
30-12	Instruction Type — WAKE	656
30-13	Instruction Type — SLEEP	656
30-14	Instruction Type — WAIT	656
30-15	Instruction Type — ADC	657
30-16	Instruction Type — I <sup>2</sup> C	657
30-17	Instruction Type — REG_RD	658
30-18	Instruction Type — REG_WR	659
30-19	Control of ULP Program Execution	660
30-20	Sample of a ULP Operation Sequence	661
30-21	I <sup>2</sup> C Read Operation	662
30-22	I <sup>2</sup> C Write Operation	663
31-1	ESP32 Power Control	673
31-2	Digital Core Voltage Regulator	674
31-3	Low-Power Voltage Regulator	675
31-4	Flash Voltage Regulator	676
31-5	Brownout Detector	676

31-6	RTC Structure	677
31-7	RTC Low-Power Clocks	678
31-8	Digital Low-Power Clocks	678
31-9	RTC States	679
31-10	Power Modes	681
31-11	ESP32 Boot Flow	683

# 1 System and Memory

## 1.1 Introduction

The ESP32 is a dual-core system with two Harvard Architecture Xtensa LX6 CPUs. All embedded memory, external memory and peripherals are located on the data bus and/or the instruction bus of these CPUs.

With some minor exceptions (see below), the address mapping of two CPUs is symmetric, meaning that they use the same addresses to access the same memory. Multiple peripherals in the system can access embedded memory via DMA.

The two CPUs are named “PRO\_CPU” and “APP\_CPU” (for “protocol” and “application”), however, for most purposes the two CPUs are interchangeable.

## 1.2 Features

- Address Space
  - Symmetric address mapping
  - 4 GB (32-bit) address space for both data bus and instruction bus
  - 1296 KB embedded memory address space
  - 19704 KB external memory address space
  - 512 KB peripheral address space
  - Some embedded and external memory regions can be accessed by either data bus or instruction bus
  - 328 KB DMA address space
- Embedded Memory
  - 448 KB Internal ROM
  - 520 KB Internal SRAM
  - 8 KB RTC FAST Memory
  - 8 KB RTC SLOW Memory
- External Memory

Off-chip SPI memory can be mapped into the available address space as external memory. Parts of the embedded memory can be used as transparent cache for this external memory.

  - Supports up to 16 MB off-Chip SPI Flash.
  - Supports up to 8 MB off-Chip SPI SRAM.
- Peripherals
  - 41 peripherals
- DMA
  - 13 modules are capable of DMA operation

The block diagram in Figure 1-1 illustrates the system structure, and the block diagram in Figure 1-2 illustrates the address map structure.



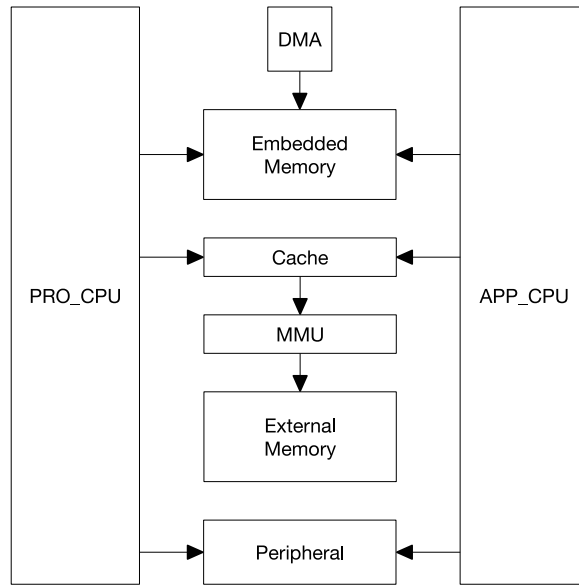


Figure 1-1. System Structure

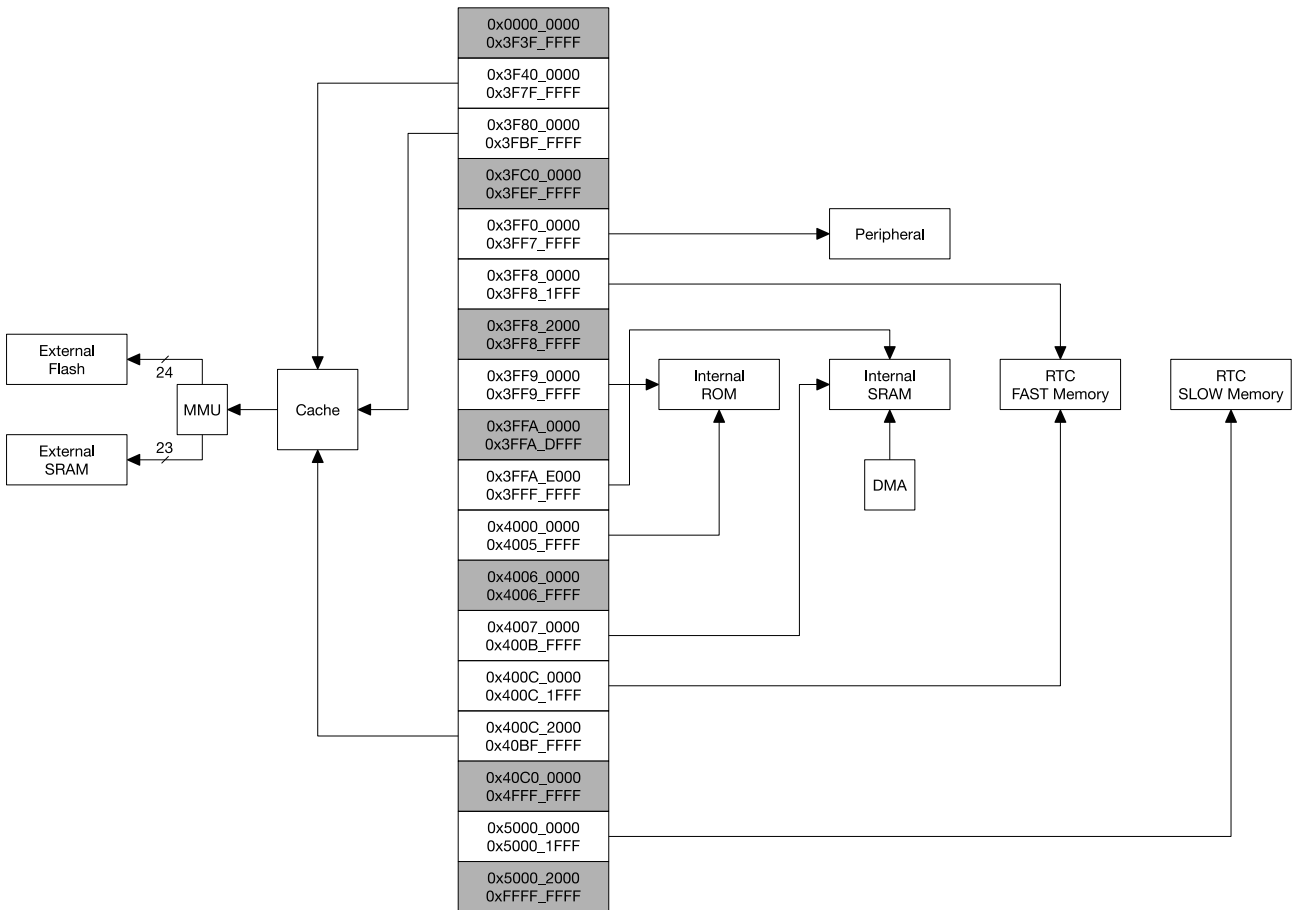


Figure 1-2. System Address Mapping

## 1.3 Functional Description

### 1.3.1 Address Mapping

Each of the two Harvard Architecture Xtensa LX6 CPUs has 4 GB (32-bit) address space. Address spaces are symmetric between the two CPUs.

Addresses below 0x4000\_0000 are serviced using the data bus. Addresses in the range 0x4000\_0000 ~ 0x4FFF\_FFFF are serviced using the instruction bus. Finally, addresses over and including 0x5000\_0000 are shared by the data and instruction bus.

The data bus and instruction bus are both little-endian: for example, byte addresses 0x0, 0x1, 0x2, 0x3 access the least significant, second least significant, second most significant, and the most significant bytes of the 32-bit word stored at the 0x0 address, respectively. The CPU can access data bus addresses via aligned or non-aligned byte, half-word and word read-and-write operations. The CPU can read and write data through the instruction bus, but only in a **word aligned manner**; non-word-aligned access will cause a CPU exception.

Each CPU can directly access embedded memory through both the data bus and the instruction bus, external memory which is mapped into the address space (via transparent caching & MMU), and peripherals. Table 1-1 illustrates address ranges that can be accessed by each CPU's data bus and instruction bus.

Some embedded memories and some external memories can be accessed via the data bus or the instruction bus. In these cases, the same memory is available to either of the CPUs at two address ranges.

**Table 1-1. Address Mapping**

Bus Type	Boundary Address		Size	Target
	Low Address	High Address		
	0x0000_0000	0x3F3F_FFFF		Reserved
Data	0x3F40_0000	0x3F7F_FFFF	4 MB	External Memory
Data	0x3F80_0000	0x3FBF_FFFF	4 MB	External Memory
	0x3FC0_0000	0x3FEF_FFFF	3 MB	Reserved
Data	0x3FF0_0000	0x3FF7_FFFF	512 KB	Peripheral
Data	0x3FF8_0000	0x3FFF_FFFF	512 KB	Embedded Memory
Instruction	0x4000_0000	0x400C_1FFF	776 KB	Embedded Memory
Instruction	0x400C_2000	0x40BF_FFFF	11512 KB	External Memory
	0x40C0_0000	0x4FFF_FFFF	244 MB	Reserved
Data / Instruction	0x5000_0000	0x5000_1FFF	8 KB	Embedded Memory
	0x5000_2000	0xFFFF_FFFF		Reserved

### 1.3.2 Embedded Memory

The Embedded Memory consists of four segments: internal ROM (448 KB), internal SRAM (520 KB), RTC FAST memory (8 KB) and RTC SLOW memory (8 KB).

The 448 KB internal ROM is divided into two parts: Internal ROM 0 (384 KB) and Internal ROM 1 (64 KB). The 520 KB internal SRAM is divided into three parts: Internal SRAM 0 (192 KB), Internal SRAM 1 (128 KB), and Internal SRAM 2 (200 KB). RTC FAST Memory and RTC SLOW Memory are both implemented as SRAM.

Table 1-2 lists all embedded memories and their address ranges on the data and instruction buses.

**Table 1-2. Embedded Memory Address Mapping**

Bus Type	Boundary Address		Size	Target	Comment
	Low Address	High Address			
Data	0x3FF8_0000	0x3FF8_1FFF	8 KB	RTC FAST Memory	<a href="#">PRO_CPU Only</a>
	0x3FF8_2000	0x3FF8_FFFF	56 KB	Reserved	-
Data	0x3FF9_0000	0x3FF9_FFFF	64 KB	Internal ROM 1	-
	0x3FFA_0000	0x3FFA_DFFF	56 KB	Reserved	-
Data	0x3FFA_E000	0x3FFD_FFFF	200 KB	Internal SRAM 2	<a href="#">DMA</a>
Data	0x3FFE_0000	0x3FFF_FFFF	128 KB	Internal SRAM 1	<a href="#">DMA</a>
Bus Type	Boundary Address		Size	Target	Comment
	Low Address	High Address			
Instruction	0x4000_0000	0x4000_7FFF	32 KB	Internal ROM 0	<a href="#">Remap</a>
Instruction	0x4000_8000	0x4005_FFFF	352 KB	Internal ROM 0	-
	0x4006_0000	0x4006_FFFF	64 KB	Reserved	-
Instruction	0x4007_0000	0x4007_FFFF	64 KB	Internal SRAM 0	<a href="#">Cache</a>
Instruction	0x4008_0000	0x4009_FFFF	128 KB	Internal SRAM 0	-
Instruction	0x400A_0000	0x400A_FFFF	64 KB	Internal SRAM 1	-
Instruction	0x400B_0000	0x400B_7FFF	32 KB	Internal SRAM 1	<a href="#">Remap</a>
Instruction	0x400B_8000	0x400B_FFFF	32 KB	Internal SRAM 1	-
Instruction	0x400C_0000	0x400C_1FFF	8 KB	RTC FAST Memory	<a href="#">PRO_CPU Only</a>
Bus Type	Boundary Address		Size	Target	Comment
	Low Address	High Address			
Data Instruction	0x5000_0000	0x5000_1FFF	8 KB	RTC SLOW Memory	-

### 1.3.2.1 Internal ROM 0

The capacity of Internal ROM 0 is 384 KB. It is accessible by both CPUs through the address range 0x4000\_0000 ~ 0x4005\_FFFF, which is on the instruction bus.

The address range of the first 32 KB of the ROM 0 (0x4000\_0000 ~ 0x4000\_7FFF) can be remapped in order to access a part of Internal SRAM 1 that normally resides in a memory range of 0x400B\_0000 ~ 0x400B\_7FFF. While remapping, the 32 KB SRAM cannot be accessed by an address range of 0x400B\_0000 ~ 0x400B\_7FFF any more, but it can still be accessible through the data bus (0x3FFE\_8000 ~ 0x3FFE\_FFFF). This can be done on a per-CPU basis: setting bit 0 of register DPORT\_PRO\_BOOT\_REMAP\_CTRL\_REG or DPORT\_APP\_BOOT\_REMAP\_CTRL\_REG will remap SRAM for the PRO\_CPU and APP\_CPU, respectively.

### 1.3.2.2 Internal ROM 1

The capacity of Internal ROM 1 is 64 KB. It can be read by either CPU at an address range 0x3FF9\_0000 ~ 0x3FF9\_FFFF of the data bus.

### 1.3.2.3 Internal SRAM 0

The capacity of Internal SRAM 0 is 192 KB. Hardware can be configured to use the first 64 KB to cache external memory access. When not used as cache, the first 64 KB can be read and written by either CPU at addresses

0x4007\_0000 ~ 0x4007\_FFFF of the instruction bus. The remaining 128 KB can always be read and written by either CPU at addresses 0x4008\_0000 ~ 0x4009\_FFFF of instruction bus.

#### 1.3.2.4 Internal SRAM 1

The capacity of Internal SRAM 1 is 128 KB. Either CPU can read and write this memory at addresses 0x3FFE\_0000 ~ 0x3FFF\_FFFF of the data bus, and also at addresses 0x400A\_0000 ~ 0x400B\_FFFF of the instruction bus.

The address range accessed via the instruction bus is in reverse order (word-wise) compared to access via the data bus. That is to say, address

0x3FFE\_0000 and 0x400B\_FFFC access the same word

0x3FFE\_0004 and 0x400B\_FFF8 access the same word

0x3FFE\_0008 and 0x400B\_FFF4 access the same word

.....

0x3FFF\_FFF4 and 0x400A\_0008 access the same word

0x3FFF\_FFF8 and 0x400A\_0004 access the same word

0x3FFF\_FFFC and 0x400A\_0000 access the same word

The data bus and instruction bus of the CPU are still both little-endian, so the byte order of individual words is not reversed between address spaces. For example, address

0x3FFE\_0000 accesses the least significant byte in the word accessed by 0x400B\_FFFC.

0x3FFE\_0001 accesses the second least significant byte in the word accessed by 0x400B\_FFFC.

0x3FFE\_0002 accesses the second most significant byte in the word accessed by 0x400B\_FFFC.

0x3FFE\_0003 accesses the most significant byte in the word accessed by 0x400B\_FFFC.

0x3FFE\_0004 accesses the least significant byte in the word accessed by 0x400B\_FFF8.

0x3FFE\_0005 accesses the second least significant byte in the word accessed by 0x400B\_FFF8.

0x3FFE\_0006 accesses the second most significant byte in the word accessed by 0x400B\_FFF8.

0x3FFE\_0007 accesses the most significant byte in the word accessed by 0x400B\_FFF8.

.....

0x3FFF\_FFF8 accesses the least significant byte in the word accessed by 0x400A\_0004.

0x3FFF\_FFF9 accesses the second least significant byte in the word accessed by 0x400A\_0004.

0x3FFF\_FFFA accesses the second most significant byte in the word accessed by 0x400A\_0004.

0x3FFF\_FFFB accesses the most significant byte in the word accessed by 0x400A\_0004.

0x3FFF\_FFFC accesses the least significant byte in the word accessed by 0x400A\_0000.

0x3FFF\_FFFD accesses the second most significant byte in the word accessed by 0x400A\_0000.

0x3FFF\_FFFE accesses the second most significant byte in the word accessed by 0x400A\_0000.

0x3FFF\_FFFF accesses the most significant byte in the word accessed by 0x400A\_0000.

Part of this memory can be remapped onto the ROM 0 address space. See [Internal Rom 0](#) for more information.

#### 1.3.2.5 Internal SRAM 2

The capacity of Internal SRAM 2 is 200 KB. It can be read and written by either CPU at addresses 0x3FFA\_E000 ~ 0x3FFD\_FFFF on the data bus.

### 1.3.2.6 DMA

DMA uses the same addressing as the CPU data bus to read and write Internal SRAM 1 and Internal SRAM 2. This means DMA uses an address range of 0x3FFE\_0000 ~ 0x3FFF\_FFFF to read and write Internal SRAM 1 and an address range of 0x3FFA\_E000 ~ 0x3FFD\_FFFF to read and write Internal SRAM 2.

In the ESP32, 13 peripherals are equipped with DMA. Table 1-3 lists these peripherals.

**Table 1-3. Module with DMA**

UART0	UART1	UART2
SPI1	SPI2	SPI3
I2S0	I2S1	
SDIO Slave	SDMMC	
EMAC		
BT	WIFI	

### 1.3.2.7 RTC FAST Memory

RTC FAST Memory is 8 KB of SRAM. It can be read and written by PRO\_CPU only at an address range of 0x3FF8\_0000 ~ 0x3FF8\_1FFF on the data bus or at an address range of 0x400C\_0000 ~ 0x400C\_1FFF on the instruction bus. Unlike most other memory regions, RTC FAST memory cannot be accessed by the APP\_CPU.

The two address ranges of PRO\_CPU access RTC FAST Memory in the same order, so, for example, addresses 0x3FF8\_0000 and 0x400C\_0000 access the same word. **On the APP\_CPU, these address ranges do not provide access to RTC FAST Memory or any other memory location.**

### 1.3.2.8 RTC SLOW Memory

RTC SLOW Memory is 8 KB of SRAM which can be read and written by either CPU at an address range of 0x5000\_0000 ~ 0x5000\_1FFF. This address range is shared by both the data bus and the instruction bus.

## 1.3.3 External Memory

The ESP32 can access external SPI flash and SPI SRAM as external memory. Table 1-4 provides a list of external memories that can be accessed by either CPU at a range of addresses on the data and instruction buses. When a CPU accesses external memory through the Cache and MMU, the cache will map the CPU's address to an external physical memory address (in the external memory's address space), according to the MMU settings. Due to this address mapping, the ESP32 can address up to 16 MB External Flash and 8 MB External SRAM.

**Table 1-4. External Memory Address Mapping**

Bus Type	Boundary Address		Size	Target	Comment
	Low Address	High Address			
Data	0x3F40_0000	0x3F7F_FFFF	4 MB	External Flash	Read
Data	0x3F80_0000	0x3FBF_FFFF	4 MB	External SRAM	Read and Write
Bus Type	Boundary Address		Size	Target	Comment
	Low Address	High Address			
Instruction	0x400C_2000	0x40BF_FFFF	11512 KB	External Flash	Read

### 1.3.4 Cache

As shown in Figure 1-3, each of the two CPUs in ESP32 has 32 KB of cache for accessing external storage. PRO CPU uses bit PRO\_CACHE\_ENABLE in register DPORT\_PRO\_CACHE\_CTRL\_REG to enable the Cache, while APP CPU uses bit APP\_CACHE\_ENABLE in register DPORT\_APP\_CACHE\_CTRL\_REG to enable the same function.

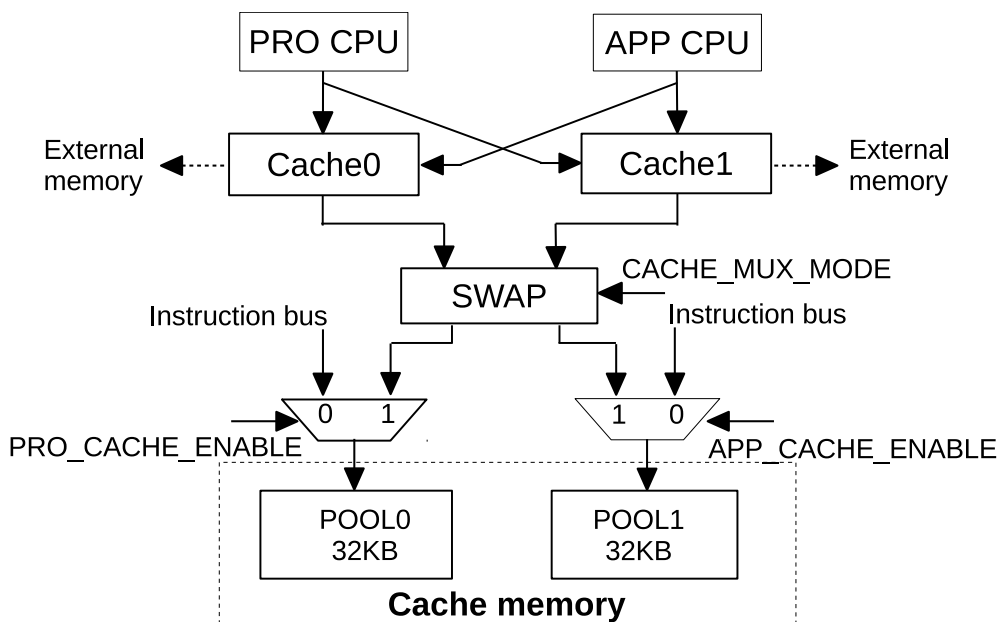


Figure 1-3. Cache Block Diagram

ESP32 uses a two-way set-associative cache. When the Cache function is to be used either by PRO CPU or APP CPU, bit CACHE\_MUX\_MODE[1:0] in register DPORT\_CACHE\_MUX\_MODE\_REG can be set to select POOL0 or POOL1 in the Internal SRAM0 as the cache memory. When both PRO CPU and APP CPU use the Cache function, POOL0 and POOL1 in the Internal SRAM0 will be used simultaneously as the cache memory, while they can also be used by the instruction bus. This is depicted in table 1-5 below.

Table 1-5. Cache memory mode

CACHE_MUX_MODE	POOL0	POOL1
0	PRO CPU	APP CPU
1	PRO CPU/APP CPU	-
2	-	PRO CPU/APP CPU
3	APP CPU	PRO CPU

As described in table 1-5, when bit CACHE\_MUX\_MODE is set to 1 or 2, PRO CPU and APP CPU cannot enable the Cache function at the same time. When the Cache function is enabled, POOL0 or POOL1 can only be used as the cache memory, and cannot be used by the instruction bus as well.

ESP32 Cache supports the Flush function. It is worth noting that when the Flush function is used, the data written in the cache will be disposed rather than being rewritten into the External SRAM. To enable the Flush function, first clear bit x\_CACHE\_FLUSH\_ENA in register DPORT\_x\_CACHE\_CTRL\_REG, then set this bit to 1. Afterwards, the system hardware will set bit x\_CACHE\_FLUSH\_DONE to 1, where x can be "PRO" or "APP", indicating that the cache flush operation has been completed.

For more information about the address mapping of ESP32 Cache, please refer to [Embedded Memory](#) and [External Memory](#).

### 1.3.5 Peripherals

The ESP32 has 41 peripherals. Table 1-6 specifically describes the peripherals and their respective address ranges. Nearly all peripheral modules can be accessed by either CPU at the same address with just a single exception; this being the PID Controller.

**Table 1-6. Peripheral Address Mapping**

Bus Type	Boundary Address		Size	Target	Comment
	Low Address	High Address			
Data	0x3FF0_0000	0x3FF0_0FFF	4 KB	DPort Register	
Data	0x3FF0_1000	0x3FF0_1FFF	4 KB	AES Accelerator	
Data	0x3FF0_2000	0x3FF0_2FFF	4 KB	RSA Accelerator	
Data	0x3FF0_3000	0x3FF0_3FFF	4 KB	SHA Accelerator	
Data	0x3FF0_4000	0x3FF0_4FFF	4 KB	Secure Boot	
	0x3FF0_5000	0x3FF0_FFFF	44 KB	Reserved	
Data	0x3FF1_0000	0x3FF1_3FFF	16 KB	Cache MMU Table	
	0x3FF1_4000	0x3FF1_EFFF	44 KB	Reserved	
Data	0x3FF1_F000	0x3FF1_FFFF	4 KB	PID Controller	<a href="#">Per-CPU peripheral</a>
	0x3FF2_0000	0x3FF3_FFFF	128 KB	Reserved	
Data	0x3FF4_0000	0x3FF4_0FFF	4 KB	UART0	
	0x3FF4_1000	0x3FF4_1FFF	4 KB	Reserved	
Data	0x3FF4_2000	0x3FF4_2FFF	4 KB	SPI1	
Data	0x3FF4_3000	0x3FF4_3FFF	4 KB	SPI0	
Data	0x3FF4_4000	0x3FF4_4FFF	4 KB	GPIO	
	0x3FF4_5000	0x3FF4_7FFF	12 KB	Reserved	
Data	0x3FF4_8000	0x3FF4_8FFF	4 KB	RTC	
Data	0x3FF4_9000	0x3FF4_9FFF	4 KB	IO MUX	
	0x3FF4_A000	0x3FF4_AFFF	4 KB	Reserved	
Data	0x3FF4_B000	0x3FF4_BFFF	4 KB	SDIO Slave	<a href="#">One of three parts</a>
Data	0x3FF4_C000	0x3FF4_CFFF	4 KB	UDMA1	
	0x3FF4_D000	0x3FF4_EFFF	8 KB	Reserved	
Data	0x3FF4_F000	0x3FF4_FFFF	4 KB	I2S0	
Data	0x3FF5_0000	0x3FF5_0FFF	4 KB	UART1	
	0x3FF5_1000	0x3FF5_2FFF	8 KB	Reserved	
Data	0x3FF5_3000	0x3FF5_3FFF	4 KB	I2C0	
Data	0x3FF5_4000	0x3FF5_4FFF	4 KB	UDMA0	
Data	0x3FF5_5000	0x3FF5_5FFF	4 KB	SDIO Slave	<a href="#">One of three parts</a>
Data	0x3FF5_6000	0x3FF5_6FFF	4 KB	RMT	
Data	0x3FF5_7000	0x3FF5_7FFF	4 KB	PCNT	
Data	0x3FF5_8000	0x3FF5_8FFF	4 KB	SDIO Slave	<a href="#">One of three parts</a>
Data	0x3FF5_9000	0x3FF5_9FFF	4 KB	LED PWM	
Data	0x3FF5_A000	0x3FF5_AFFF	4 KB	Efuse Controller	
Data	0x3FF5_B000	0x3FF5_BFFF	4 KB	Flash Encryption	

Bus Type	Boundary Address		Size	Target	Comment
	Low Address	High Address			
	0x3FF5_C000	0x3FF5_DFFF	8 KB	Reserved	
Data	0x3FF5_E000	0x3FF5_EFFF	4 KB	MCPWM0	
Data	0x3FF5_F000	0x3FF5_FFFF	4 KB	TIMG0	
Data	0x3FF6_0000	0x3FF6_0FFF	4 KB	TIMG1	
	0x3FF6_1000	0x3FF6_3FFF	12 KB	Reserved	
Data	0x3FF6_4000	0x3FF6_4FFF	4 KB	SPI2	
Data	0x3FF6_5000	0x3FF6_5FFF	4 KB	SPI3	
Data	0x3FF6_6000	0x3FF6_6FFF	4 KB	SYSCON	
Data	0x3FF6_7000	0x3FF6_7FFF	4 KB	I2C1	
Data	0x3FF6_8000	0x3FF6_8FFF	4 KB	SDMMC	
Data	0x3FF6_9000	0x3FF6_AFFF	8 KB	EMAC	
Data	0x3FF6_B000	0x3FF6_BFFF	4KB	TWAI	
Data	0x3FF6_C000	0x3FF6_CFFF	4 KB	MCPWM1	
Data	0x3FF6_D000	0x3FF6_DFFF	4 KB	I2S1	
Data	0x3FF6_E000	0x3FF6_EFFF	4 KB	UART2	
Data	0x3FF6_F000	0x3FF6_FFFF	4 KB	Reserved	
Data	0x3FF7_0000	0x3FF7_0FFF	4 KB	Reserved	
	0x3FF7_1000	0x3FF7_4FFF	16 KB	Reserved	
Data	0x3FF7_5000	0x3FF7_5FFF	4 KB	RNG	
	0x3FF7_6000	0x3FF7_FFFF	40 KB	Reserved	

**Notice:**

- Peripherals accessed by the CPU via 0x3FF40000 ~ 0x3FF7FFFF address space (DPORT address) can also be accessed via 0x60000000 ~ 0x6003FFFF (AHB address). (0x3FF40000 + n) address and (0x60000000 + n) address access the same content, where n = 0 ~ 0x3FFFF.
- The CPU can access peripherals via DPORT address more efficiently than via AHB address. However, DPORT address is characterized by speculative reads, which means it cannot guarantee that each read is valid. In addition, DPORT address will upset the order of r/w operations on the bus to improve performance, which may cause programs that have strict requirements on the r/w order to crash. On the other hand, using AHB address to read FIFO registers will cause unpredictable errors. To address above issues please strictly follow the instructions documented in [ESP32 ECO and Workarounds for Bugs](#), specifically sections 3.3, 3.10, 3.16, and 3.17.

**1.3.5.1 Asymmetric PID Controller Peripheral**

There are two PID Controllers in the system. They serve the PRO\_CPU and the APP\_CPU, respectively. **The PRO\_CPU and the APP\_CPU can only access their own PID Controller and not that of their counterpart.** Each CPU uses the same memory range 0x3FF1\_F000 ~ 3FF1\_FFFF to access its own PID Controller.

**1.3.5.2 Non-Contiguous Peripheral Memory Ranges**

The SDIO Slave peripheral consists of three parts and the two CPUs use non-contiguous addresses to access these. The three parts are accessed at the address ranges 0x3FF4\_B000 ~ 3FF4\_BFFF, 0x3FF5\_5000 ~



3FF5\_5FFF and 0x3FF5\_8000 ~ 3FF5\_8FFF of each CPU's data bus. Similarly to other peripherals, access to this peripheral is identical for both CPUs.

### 1.3.5.3 Memory Speed

The ROM as well as the SRAM are both clocked from CPU\_CLK and can be accessed by the CPU in a single cycle. The RTC FAST memory is clocked from the APB\_CLOCK and the RTC SLOW memory from the FAST\_CLOCK, so access to these memories may be slower. DMA uses the APB\_CLK to access memory.

Internally, the SRAM is organized in 32K-sized banks. Each CPU and DMA channel can simultaneously access the SRAM at full speed, provided they access addresses in different memory banks.

## 2 Interrupt Matrix (INTERRUPT)

### 2.1 Overview

The Interrupt Matrix embedded in the ESP32 independently allocates peripheral interrupt sources to the two CPUs' peripheral interrupts. This configuration is made to be highly flexible in order to meet many different needs.

### 2.2 Features

- Accepts 71 peripheral interrupt sources as input.
- Generates 26 peripheral interrupt sources per CPU as output (52 total).
- CPU NMI Interrupt Mask.
- Queries current interrupt status of peripheral interrupt sources.

The structure of the Interrupt Matrix is shown in Figure 2-1.

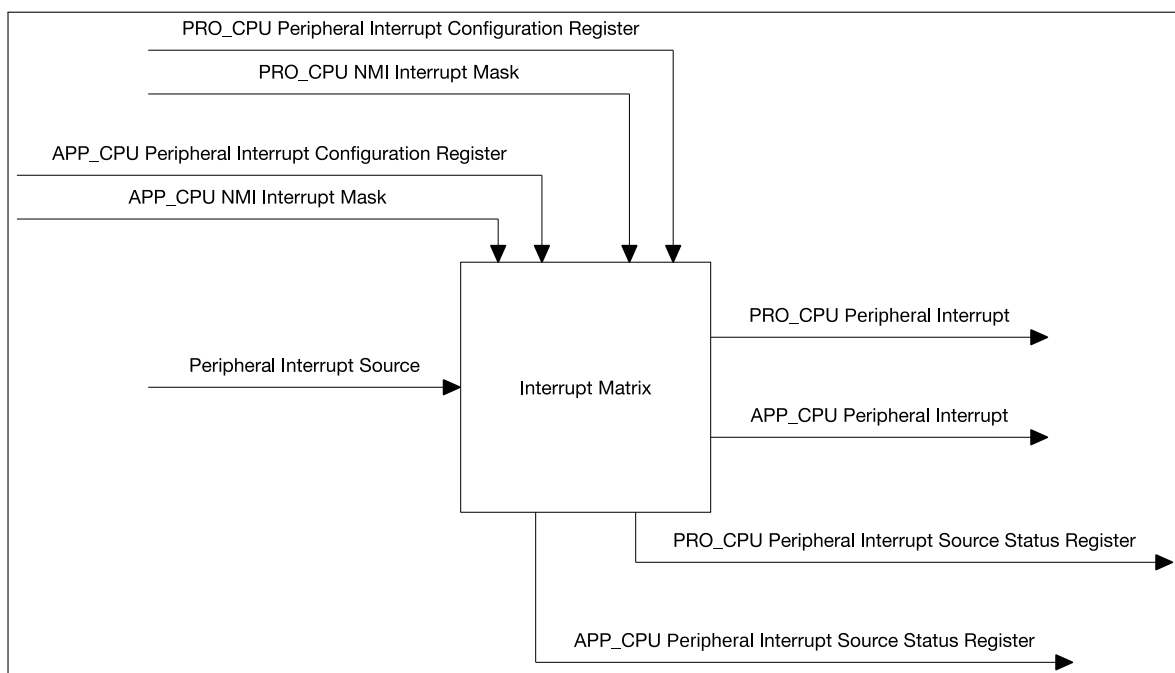


Figure 2-1. Interrupt Matrix Structure

### 2.3 Functional Description

#### 2.3.1 Peripheral Interrupt Source

ESP32 has 71 peripheral interrupt sources in total. All peripheral interrupt sources are listed in table 2-1. 67 of 71 ESP32 peripheral interrupt sources can be allocated to either CPU.

The four remaining peripheral interrupt sources are CPU-specific, two per CPU. `GPIO_INTERRUPT_PRO` and `GPIO_INTERRUPT_PRO_NMI` can only be allocated to PRO\_CPU. `GPIO_INTERRUPT_APP` and `GPIO_INTERRUPT_APP_NMI` can only be allocated to APP\_CPU. As a result, PRO\_CPU and APP\_CPU each have 69 peripheral interrupt sources.

Table 2-1. PRO\_CPU, APP\_CPU Interrupt Configuration

PRO_CPU				APP_CPU			
Peripheral Interrupt Configuration Register	Bit	Status Register Name	Peripheral Interrupt Source		Status Register Name	Bit	Peripheral Interrupt Configuration Register
			No.	Name			
DPORT_PRO_MAC_INTR_MAP_REG	0	DPORT_PRO_INTR_STATUS_REG_0_REG	0	MAC_INTR	0	DPORT_APP_INTR_STATUS_REG_0_REG	DPORT_APP_MAC_INTR_MAP_REG
DPORT_PRO_MAC_NMI_MAP_REG	1		1	MAC_NMI	1		DPORT_APP_MAC_NMI_MAP_REG
DPORT_PRO_BB_INT_MAP_REG	2		2	BB_INT	2		DPORT_APP_BB_INT_MAP_REG
DPORT_PRO_BT_MAC_INT_MAP_REG	3		3	BT_MAC_INT	3		DPORT_APP_BT_MAC_INT_MAP_REG
DPORT_PRO_BT_BB_INT_MAP_REG	4		4	BT_BB_INT	4		DPORT_APP_BT_BB_INT_MAP_REG
DPORT_PRO_BT_BB_NMI_MAP_REG	5		5	BT_BB_NMI	5		DPORT_APP_BT_BB_NMI_MAP_REG
DPORT_PRO_RWBTT_IRQ_MAP_REG	6		6	RWBTT_IRQ	6		DPORT_APP_RWBTT_IRQ_MAP_REG
DPORT_PRO_RWBTT_IRQ_MAP_REG	7		7	RWBTT_IRQ	7		DPORT_APP_RWBTT_IRQ_MAP_REG
DPORT_PRO_RWBTT_NMI_MAP_REG	8		8	RWBTT_NMI	8		DPORT_APP_RWBTT_NMI_MAP_REG
DPORT_PRO_RWBTT_NMI_MAP_REG	9		9	RWBTT_NMI	9		DPORT_APP_RWBTT_NMI_MAP_REG
DPORT_PRO_SLC0_INTR_MAP_REG	10		10	SLC0_INTR	10		DPORT_APP_SLC0_INTR_MAP_REG
DPORT_PRO_SLC1_INTR_MAP_REG	11		11	SLC1_INTR	11		DPORT_APP_SLC1_INTR_MAP_REG
DPORT_PRO_UHCIO_INTR_MAP_REG	12		12	UHCIO_INTR	12		DPORT_APP_UHCIO_INTR_MAP_REG
DPORT_PRO_UHC1_INTR_MAP_REG	13		13	UHC1_INTR	13		DPORT_APP_UHC1_INTR_MAP_REG
DPORT_PRO_TG_TO_LEVEL_INT_MAP_REG	14		14	TG_TO_LEVEL_INT	14		DPORT_APP_TG_TO_LEVEL_INT_MAP_REG
DPORT_PRO_TG_T1_LEVEL_INT_MAP_REG	15		15	TG_T1_LEVEL_INT	15		DPORT_APP_TG_T1_LEVEL_INT_MAP_REG
DPORT_PRO_TG_WDT_LEVEL_INT_MAP_REG	16		16	TG_WDT_LEVEL_INT	16		DPORT_APP_TG_WDT_LEVEL_INT_MAP_REG
DPORT_PRO_TG_LACT_LEVEL_INT_MAP_REG	17		17	TG_LACT_LEVEL_INT	17		DPORT_APP_TG_LACT_LEVEL_INT_MAP_REG
DPORT_PRO_TG1_TO_LEVEL_INT_MAP_REG	18		18	TG1_TO_LEVEL_INT	18		DPORT_APP_TG1_TO_LEVEL_INT_MAP_REG
DPORT_PRO_TG1_T1_LEVEL_INT_MAP_REG	19		19	TG1_T1_LEVEL_INT	19		DPORT_APP_TG1_T1_LEVEL_INT_MAP_REG
DPORT_PRO_TG1_WDT_LEVEL_INT_MAP_REG	20		20	TG1_WDT_LEVEL_INT	20		DPORT_APP_TG1_WDT_LEVEL_INT_MAP_REG
DPORT_PRO_TG1_LACT_LEVEL_INT_MAP_REG	21		21	TG1_LACT_LEVEL_INT	21		DPORT_APP_TG1_LACT_LEVEL_INT_MAP_REG
DPORT_PRO_GPIO_INTERRUPT_MAP_REG	22		GPIO_INTERRUPT_PRO   GPIO_INTERRUPT_APP		22	DPORT_APP_GPIO_INTERRUPT_MAP_REG	
DPORT_PRO_GPIO_INTERRUPT_NMI_MAP_REG	23		GPIO_INTERRUPT_PRO_NMI   GPIO_INTERRUPT_APP_NMI		23	DPORT_APP_GPIO_INTERRUPT_NMI_MAP_REG	
DPORT_PRO_CPU_INTR_FROM_CPU_0_MAP_REG	24		24	CPU_INTR_FROM_CPU_0	24	DPORT_APP_CPU_INTR_FROM_CPU_0_MAP_REG	
DPORT_PRO_CPU_INTR_FROM_CPU_1_MAP_REG	25		25	CPU_INTR_FROM_CPU_1	25	DPORT_APP_CPU_INTR_FROM_CPU_1_MAP_REG	
DPORT_PRO_CPU_INTR_FROM_CPU_2_MAP_REG	26		26	CPU_INTR_FROM_CPU_2	26	DPORT_APP_CPU_INTR_FROM_CPU_2_MAP_REG	
DPORT_PRO_CPU_INTR_FROM_CPU_3_MAP_REG	27		27	CPU_INTR_FROM_CPU_3	27	DPORT_APP_CPU_INTR_FROM_CPU_3_MAP_REG	
DPORT_PRO_SPI_INTR_0_MAP_REG	28		28	SPI_INTR_0	28	DPORT_APP_SPI_INTR_0_MAP_REG	
DPORT_PRO_SPI_INTR_1_MAP_REG	29		29	SPI_INTR_1	29	DPORT_APP_SPI_INTR_1_MAP_REG	
DPORT_PRO_SPI_INTR_2_MAP_REG	30		30	SPI_INTR_2	30	DPORT_APP_SPI_INTR_2_MAP_REG	
DPORT_PRO_SPI_INTR_3_MAP_REG	31		31	SPI_INTR_3	31	DPORT_APP_SPI_INTR_3_MAP_REG	
DPORT_PRO_I2S0_INT_MAP_REG	0	DPORT_PRO_INTR_STATUS_REG_1_REG	32	I2S0_INT	32	DPORT_APP_INTR_STATUS_REG_1_REG	DPORT_APP_I2S0_INT_MAP_REG
DPORT_PRO_I2S1_INT_MAP_REG	1		33	I2S1_INT	33		DPORT_APP_I2S1_INT_MAP_REG
DPORT_PRO_UART_INTR_MAP_REG	2		34	UART_INTR	34		DPORT_APP_UART_INTR_MAP_REG
DPORT_PRO_UART1_INTR_MAP_REG	3		35	UART1_INTR	35		DPORT_APP_UART1_INTR_MAP_REG
DPORT_PRO_UART2_INTR_MAP_REG	4		36	UART2_INTR	36		DPORT_APP_UART2_INTR_MAP_REG
DPORT_PRO_SDIO_HOST_INTERRUPT_MAP_REG	5		37	SDIO_HOST_INTERRUPT	37		DPORT_APP_SDIO_HOST_INTERRUPT_MAP_REG
DPORT_PRO_EMAC_INT_MAP_REG	6		38	EMAC_INT	38		DPORT_APP_EMAC_INT_MAP_REG
DPORT_PRO_PWM0_INTR_MAP_REG	7		39	PWM0_INTR	39		DPORT_APP_PWM0_INTR_MAP_REG
DPORT_PRO_PWM1_INTR_MAP_REG	8		40	PWM1_INTR	40		DPORT_APP_PWM1_INTR_MAP_REG
Reserved	9		41	Reserved	41		Reserved
Reserved	10		42	Reserved	42		Reserved
DPORT_PRO_LEDC_INT_MAP_REG	11		43	LEDC_INT	43		DPORT_APP_LEDC_INT_MAP_REG
DPORT_PRO_EFUSE_INT_MAP_REG	12		44	EFUSE_INT	44		DPORT_APP_EFUSE_INT_MAP_REG
DPORT_PRO_TWAI_INT_MAP_REG	13		45	TWAI_INT	45		DPORT_APP_TWAI_INT_MAP_REG
DPORT_PRO_RTC_CORE_INTR_MAP_REG	14		46	RTC_CORE_INTR	46		DPORT_APP_RTC_CORE_INTR_MAP_REG
DPORT_PRO_RMT_INTR_MAP_REG	15		47	RMT_INTR	47		DPORT_APP_RMT_INTR_MAP_REG
DPORT_PRO_PCNT_INTR_MAP_REG	16		48	PCNT_INTR	48		DPORT_APP_PCNT_INTR_MAP_REG
DPORT_PRO_I2C_EXT0_INTR_MAP_REG	17		49	I2C_EXT0_INTR	49		DPORT_APP_I2C_EXT0_INTR_MAP_REG
DPORT_PRO_I2C_EXT1_INTR_MAP_REG	18		50	I2C_EXT1_INTR	50		DPORT_APP_I2C_EXT1_INTR_MAP_REG
DPORT_PRO_RSA_INTR_MAP_REG	19		51	RSA_INTR	51		DPORT_APP_RSA_INTR_MAP_REG
DPORT_PRO_SPI1_DMA_INT_MAP_REG	20		52	SPI1_DMA_INT	52		DPORT_APP_SPI1_DMA_INT_MAP_REG

PRO_CPU				APP_CPU				
Peripheral Interrupt Configuration Register	Peripheral Interrupt Source			Peripheral Interrupt Configuration Register	Peripheral Interrupt Source			
	Bit	Status Register Name	No.		Name	No.	Status Register Name	Bit
DPORT_PRO_SPI2_DMA_INT_MAP_REG	21	DPORT_PRO_INTR_STATUS_REG_1_REG	53	SPI2_DMA_INT	53	DPORT_APP_INTR_STATUS_REG_1_REG	21	DPORT_APP_SPI2_DMA_INT_MAP_REG
DPORT_PRO_SPI3_DMA_INT_MAP_REG	22		54	SPI3_DMA_INT	54		22	DPORT_APP_SPI3_DMA_INT_MAP_REG
DPORT_PRO_WDG_INT_MAP_REG	23		55	WDG_INT	55		23	DPORT_APP_WDG_INT_MAP_REG
DPORT_PRO_TIMER_INT1_MAP_REG	24		56	TIMER_INT1	56		24	DPORT_APP_TIMER_INT1_MAP_REG
DPORT_PRO_TIMER_INT2_MAP_REG	25		57	TIMER_INT2	57		25	DPORT_APP_TIMER_INT2_MAP_REG
DPORT_PRO_TG_T0_EDGE_INT_MAP_REG	26		58	TG_T0_EDGE_INT	58		26	DPORT_APP_TG_T0_EDGE_INT_MAP_REG
DPORT_PRO_TG_T1_EDGE_INT_MAP_REG	27		59	TG_T1_EDGE_INT	59		27	DPORT_APP_TG_T1_EDGE_INT_MAP_REG
DPORT_PRO_TG_WDT_EDGE_INT_MAP_REG	28		60	TG_WDT_EDGE_INT	60		28	DPORT_APP_TG_WDT_EDGE_INT_MAP_REG
DPORT_PRO_TG_LACT_EDGE_INT_MAP_REG	29		61	TG_LACT_EDGE_INT	61		29	DPORT_APP_TG_LACT_EDGE_INT_MAP_REG
DPORT_PRO_TG1_T0_EDGE_INT_MAP_REG	30		62	TG1_T0_EDGE_INT	62		30	DPORT_APP_TG1_T0_EDGE_INT_MAP_REG
DPORT_PRO_TG1_T1_EDGE_INT_MAP_REG	31		63	TG1_T1_EDGE_INT	63		31	DPORT_APP_TG1_T1_EDGE_INT_MAP_REG
DPORT_PRO_TG1_WDT_EDGE_INT_MAP_REG	0		64	TG1_WDT_EDGE_INT	64		0	DPORT_APP_TG1_WDT_EDGE_INT_MAP_REG
DPORT_PRO_TG1_LACT_EDGE_INT_MAP_REG	1		65	TG1_LACT_EDGE_INT	65		1	DPORT_APP_TG1_LACT_EDGE_INT_MAP_REG
DPORT_PRO_MMU_IA_INT_MAP_REG	2	DPORT_PRO_INTR_STATUS_REG_2_REG	66	MMU_IA_INT	66	DPORT_APP_INTR_STATUS_REG_2_REG	2	DPORT_APP_MMU_IA_INT_MAP_REG
DPORT_PRO_MPU_IA_INT_MAP_REG	3		67	MPU_IA_INT	67		3	DPORT_APP_MPU_IA_INT_MAP_REG
DPORT_PRO_CACHE_IA_INT_MAP_REG	4		68	CACHE_IA_INT	68		4	DPORT_APP_CACHE_IA_INT_MAP_REG

### 2.3.2 CPU Interrupt

Both of the two CPUs (PRO and APP) have 32 interrupts each, of which 26 are peripheral interrupts. All interrupts in a CPU are listed in Table 2-2.

**Table 2-2. CPU Interrupts**

No.	Category	Type	Priority Level
0	Peripheral	Level-Triggered	1
1	Peripheral	Level-Triggered	1
2	Peripheral	Level-Triggered	1
3	Peripheral	Level-Triggered	1
4	Peripheral	Level-Triggered	1
5	Peripheral	Level-Triggered	1
6	Internal	Timer.0	1
7	Internal	Software	1
8	Peripheral	Level-Triggered	1
9	Peripheral	Level-Triggered	1
10	Peripheral	Edge-Triggered	1
11	Internal	Profiling	3
12	Peripheral	Level-Triggered	1
13	Peripheral	Level-Triggered	1
14	Peripheral	NMI	NMI
15	Internal	Timer.1	3
16	Internal	Timer.2	5
17	Peripheral	Level-Triggered	1
18	Peripheral	Level-Triggered	1
19	Peripheral	Level-Triggered	2
20	Peripheral	Level-Triggered	2
21	Peripheral	Level-Triggered	2
22	Peripheral	Edge-Triggered	3
23	Peripheral	Level-Triggered	3
24	Peripheral	Level-Triggered	4
25	Peripheral	Level-Triggered	4
26	Peripheral	Level-Triggered	5
27	Peripheral	Level-Triggered	3
28	Peripheral	Edge-Triggered	4
29	Internal	Software	3
30	Peripheral	Edge-Triggered	4
31	Peripheral	Level-Triggered	5

### 2.3.3 Allocate Peripheral Interrupt Sources to Peripheral Interrupt on CPU

In this section:

- Source\_X stands for any particular peripheral interrupt source.
- PRO\_X\_MAP\_REG (or APP\_X\_MAP\_REG) stands for any particular peripheral interrupt configuration register

of the PRO\_CPU (or APP\_CPU). The peripheral interrupt configuration register corresponds to the peripheral interrupt source Source\_X. In Table 2-1 the registers listed under “PRO\_CPU (APP\_CPU) - Peripheral Interrupt Configuration Register” correspond to the peripheral interrupt sources listed in “Peripheral Interrupt Source - Name”.

- Interrupt\_P stands for CPU peripheral interrupt, numbered as Num\_P. Num\_P can take the ranges 0 ~ 5, 8 ~ 10, 12 ~ 14, 17 ~ 28, 30 ~ 31.
- Interrupt\_I stands for the CPU internal interrupt numbered as Num\_I. Num\_I can take values 6, 7, 11, 15, 16, 29.

Using this terminology, the possible operations of the Interrupt Matrix controller can be described as follows:

- **Allocate peripheral interrupt source Source\_X to CPU (PRO\_CPU or APP\_CPU)**  
Set PRO\_X\_MAP\_REG or APP\_X\_MAP\_REG to Num\_P. Num\_P can be any CPU peripheral interrupt number. CPU interrupts can be shared between multiple peripherals (see below).
- **Disable peripheral interrupt source Source\_X for CPU (PRO\_CPU or APP\_CPU)**  
Set PRO\_X\_MAP\_REG or APP\_X\_MAP\_REG for peripheral interrupt source to any Num\_I. The specific choice of internal interrupt number does not change behaviour, as none of the interrupt numbered as Num\_I is connected to either CPU.
- **Allocate multiple peripheral sources Source\_X<sub>n</sub> ORed to PRO\_CPU (APP\_CPU) peripheral interrupt**  
Set multiple PRO\_X<sub>n</sub>\_MAP\_REG (APP\_X<sub>n</sub>\_MAP\_REG) to the same Num\_P. Any of these peripheral interrupts will trigger CPU Interrupt\_P.

### 2.3.4 CPU NMI Interrupt Mask

The Interrupt Matrix temporarily masks all peripheral interrupt sources allocated to PRO\_CPU's ( or APP\_CPU's ) NMI interrupt, if it receives the signal PRO\_CPU NMI Interrupt Mask ( or APP\_CPU NMI Interrupt Mask ) from the peripheral PID Controller, respectively.

### 2.3.5 Query Current Interrupt Status of Peripheral Interrupt Source

The current interrupt status of a peripheral interrupt source can be read via the bit value in PRO\_INTR\_STATUS\_REG\_<sub>n</sub> (APP\_INTR\_STATUS\_REG\_<sub>n</sub>), as shown in the mapping in Table 2-1.

## 2.4 Registers

The interrupt matrix registers are part of the DPORT registers and are described in Section 5.4 in Chapter 5 *DPort Registers*.

## 3 Reset and Clock

### 3.1 System Reset

#### 3.1.1 Introduction

The ESP32 has three reset levels: CPU reset, Core reset, and System reset. None of these reset levels clear the RAM. Figure 3-1 shows the subsystems included in each reset level.

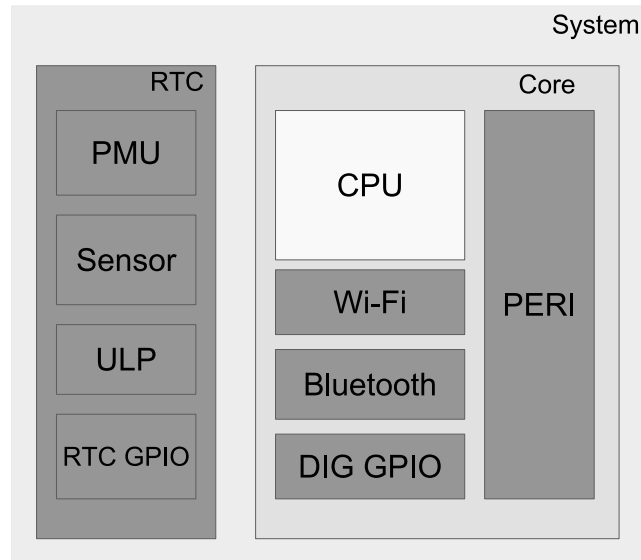


Figure 3-1. System Reset

- CPU reset: Only resets the registers of one or both of the CPU cores.
- Core reset: Resets all the digital registers, including CPU cores, external GPIO and digital GPIO. The RTC is not reset.
- System reset: Resets all the registers on the chip, including those of the RTC.

#### 3.1.2 Reset Source

While most of the time the APP\_CPU and PRO\_CPU will be reset simultaneously, some reset sources are able to reset only one of the two cores. The reset reason for each core can be looked up individually: the PRO\_CPU reset reason will be stored in RTC\_CNTL\_RESET\_CAUSE\_PROCPU, the reset reason for the APP\_CPU in RTC\_CNTL\_RESET\_CAUSE\_APPCPU. Table 3-1 shows the possible reset reason values that can be read from these registers.

Table 3-1. PRO\_CPU and APP\_CPU Reset Reason Values

PRO	APP	Source	Reset Type	Note
0x01	0x01	Chip Power On Reset	System Reset	-
0x10	0x10	RWDT System Reset	System Reset	See <a href="#">WDT Chapter</a> .
0x0F	0x0F	Brown Out Reset	System Reset	See <a href="#">Power Management Chapter</a> .
0x03	0x03	Software System Reset	Core Reset	Configure RTC_CNTL_SW_SYS_RST register.
0x05	0x05	Deep Sleep Reset	Core Reset	See <a href="#">Power Management Chapter</a> .
0x07	0x07	MWDT0 Global Reset	Core Reset	See <a href="#">WDT Chapter</a> .
0x08	0x08	MWDT1 Global Reset	Core Reset	See <a href="#">WDT Chapter</a> .

PRO	APP	APP Source	Reset Type	Note
0x09	0x09	RWDT Core Reset	Core Reset	See <a href="#">WDT Chapter</a> .
0x0B	-	MWDT0 CPU Reset	CPU Reset	See <a href="#">WDT Chapter</a> .
0x0C	-	Software CPU Reset	CPU Reset	Configure RTC_CNTL_SW_APPCPU_RST register.
-	0x0B	MWDT1 CPU Reset	CPU Reset	See <a href="#">WDT Chapter</a> .
-	0x0C	Software CPU Reset	CPU Reset	Configure RTC_CNTL_SW_APPCPU_RST register.
0x0D	0x0D	RWDT CPU Reset	CPU Reset	See <a href="#">WDT Chapter</a> .
-	0xE	PRO CPU Reset	CPU Reset	Indicates that the PRO CPU has independently reset the APP CPU by configuring the DPORT_APPCPU_RESETTING register.

## 3.2 System Clock

### 3.2.1 Introduction

The ESP32 integrates multiple clock sources for the CPU cores, the peripherals and the RTC. These clocks can be configured to meet different requirements. Figure 3-2 shows the system clock structure.

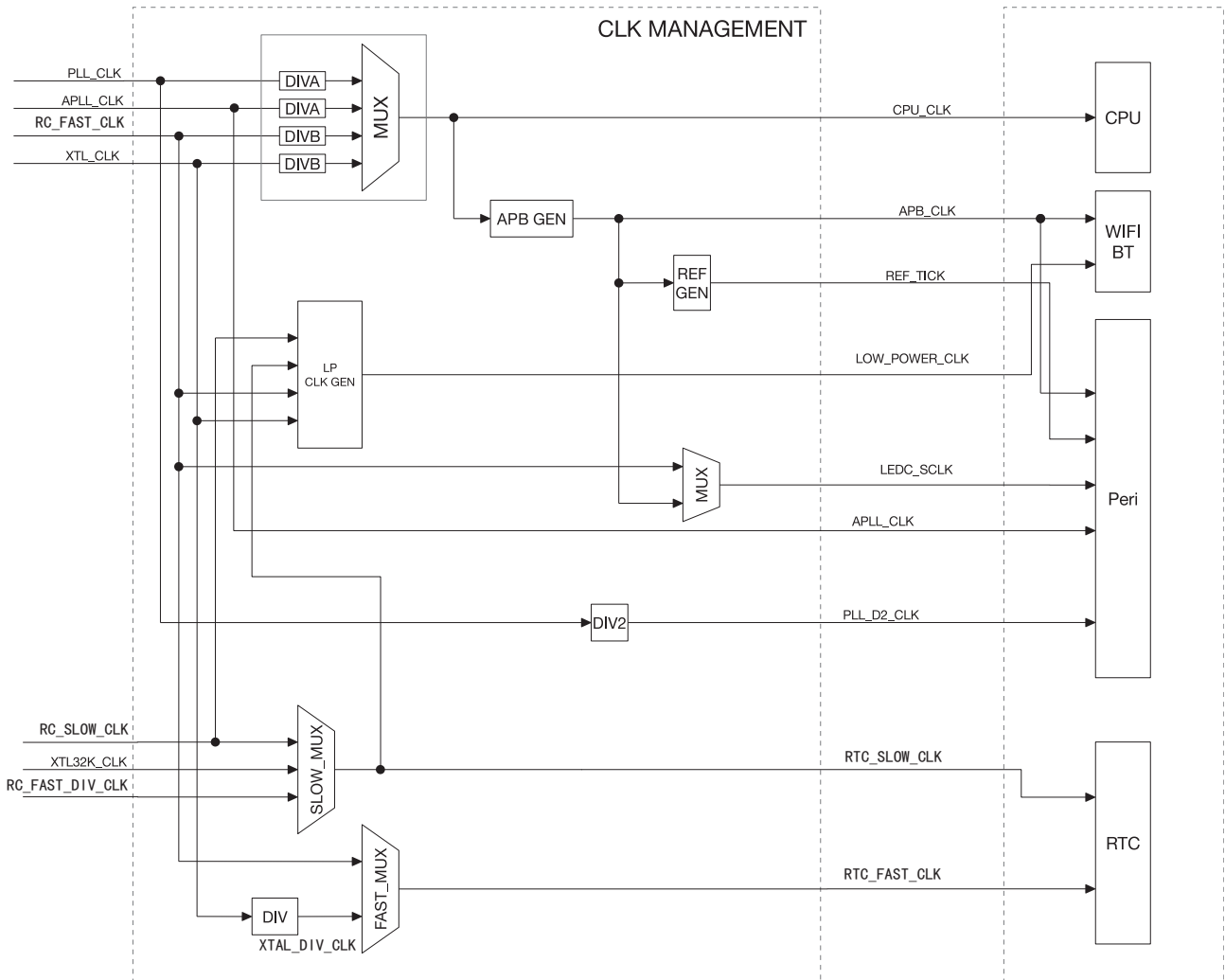


Figure 3-2. System Clock



### 3.2.2 Clock Source

The ESP32 can use an external crystal oscillator, an internal PLL or an oscillating circuit as a clock source. Specifically, the clock sources available are:

- High Speed Clocks
  - PLL\_CLK is an internal PLL clock with a frequency of 320 MHz or 480 MHz.
  - XTL\_CLK is a clock signal generated using an external crystal with a frequency range of 2 ~ 40 MHz.
- Low Power Clocks
  - XTL32K\_CLK is a clock generated using an external crystal with a frequency of 32 KHz.
  - RC\_FAST\_CLK is an internal clock with a default frequency of 8 MHz. This frequency is adjustable.
  - RC\_FAST\_DIV\_CLK is divided from RC\_FAST\_CLK. Its frequency is (RC\_FAST\_CLK / 256). With the default RC\_FAST\_CLK frequency of 8 MHz, this clock runs at 31.250 KHz.
  - RC\_SLOW\_CLK is an internal low power clock with a default frequency of 150 KHz. This frequency is adjustable.
- Audio Clock
  - APLL\_CLK is an internal Audio PLL clock with a frequency range of 16 ~ 128 MHz.

### 3.2.3 CPU Clock

As Figure 3-2 shows, CPU\_CLK is the master clock for both CPU cores. CPU\_CLK clock can be as high as 240 MHz when the CPU is in high performance mode. Alternatively, the CPU can run at lower frequencies to reduce power consumption.

The CPU\_CLK clock source is determined by the [RTC\\_CNTL\\_SOC\\_CLK\\_SEL](#) register. PLL\_CLK, APLL\_CLK, RC\_FAST\_CLK, and XTL\_CLK can be set as the CPU\_CLK source; see Table 3-2 and 3-3.

**Table 3-2. CPU\_CLK Source**

RTC_CNTL_SOC_CLK_SEL Value	Clock Source
0	XTL_CLK
1	PLL_CLK
2	RC_FAST_CLK
3	APLL_CLK

**Table 3-3. CPU\_CLK Derivation**

Clock Source	*SEL_0	*SEL_1	CPU Clock
XTL_CLK	0	-	$\text{CPU\_CLK} = \text{XTL\_CLK} / (\text{APB\_CTRL\_PRE\_DIV\_CNT} + 1)$ APB_CTRL_PRE_DIV_CNT range is 0 ~ 1023. Default is 0.
PLL_CLK (320 MHz)	1	0	$\text{CPU\_CLK} = \text{PLL\_CLK} / 4$ CPU_CLK frequency is 80 MHz
PLL_CLK (320 MHz)	1	1	$\text{CPU\_CLK} = \text{PLL\_CLK} / 2$ CPU_CLK frequency is 160 MHz
PLL_CLK (480 MHz)	1	2	$\text{CPU\_CLK} = \text{PLL\_CLK} / 2$ CPU_CLK frequency is 240 MHz

RC_FAST_CLK	2	-	CPU_CLK = RC_FAST_CLK / (APB_CTRL_PRE_DIV_CNT+1) APB_CTRL_PRE_DIV_CNT range is 0 ~ 1023. Default is 0.
APLL_CLK	3	0	CPU_CLK = APLL_CLK / 4
APLL_CLK	3	1	CPU_CLK = APLL_CLK / 2

\*SEL\_0: The value of register [RTC\\_CNTL\\_SOC\\_CLK\\_SEL](#)

\*SEL\_1: The value of register [CPU\\_CPUPERIOD\\_SEL](#)

### 3.2.4 Peripheral Clock

Peripheral clocks include APB\_CLK, REF\_TICK, LEDC\_SCLK, APLL\_CLK, and PLL\_D2\_CLK.

Table 3-4 shows which clocks can be used by which peripherals.

**Table 3-4. Peripheral Clock Usage**

Peripherals	APB_CLK	REF_TICK	LEDC_SCLK	APLL_CLK	PLL_D2_CLK
EMAC	Y	N	N	Y	N
TIMG	Y	N	N	N	N
I2S	Y	N	N	Y	Y
UART	Y	Y	N	N	N
RMT	Y	Y	N	N	N
LED PWM	Y	Y	Y	N	N
PWM	Y	N	N	N	N
I2C	Y	N	N	N	N
SPI	Y	N	N	N	N
PCNT	Y	N	N	N	N
eFuse Controller	Y	N	N	N	N
SDIO Slave	Y	N	N	N	N
SDMMC	Y	N	N	N	N

#### 3.2.4.1 APB\_CLK Source

The APB\_CLK is derived from CPU\_CLK as detailed in Table 3-5. The division factor depends on the CPU\_CLK source.

**Table 3-5. APB\_CLK Derivation**

CPU_CLK Source	APB_CLK
PLL_CLK	80 MHz
APLL_CLK	CPU_CLK / 2
XTAL_CLK	CPU_CLK
RC_FAST_CLK	CPU_CLK

#### 3.2.4.2 REF\_TICK Source

REF\_TICK is derived from APB\_CLK via a divider. The divider value used depends on the APB\_CLK source, which in turn depends on the CPU\_CLK source.

By configuring correct divider values for each APB\_CLK source, the user can ensure that the REF\_TICK frequency does not change when CPU\_CLK changes source, causing the APB\_CLK frequency to change.

Clock divider registers are shown in Table 3-6.

**Table 3-6. REF\_TICK Derivation**

CPU_CLK & APB_CLK Source	Clock Divider Register
PLL_CLK	APB_CTRL_PLL_TICK_NUM
XTAL_CLK	APB_CTRL_XTAL_TICK_NUM
APLL_CLK	APB_CTRL_APLL_TICK_NUM
RC_FAST_CLK	APB_CTRL_CK8M_TICK_NUM

### 3.2.4.3 LEDC\_SCLK Source

The LEDC\_SCLK clock source is selected by the LEDC\_APB\_CLK\_SEL register, as shown in Table 3-7.

**Table 3-7. LEDC\_SCLK Derivation**

LEDC_APB_CLK_SEL Value	LEDC_SCLK Source
0	RC_FAST_CLK
1	APB_CLK

### 3.2.4.4 APLL\_SCLK Source

The APLL\_CLK is sourced from PLL\_CLK, with its output frequency configured using the APLL configuration registers.

### 3.2.4.5 PLL\_D2\_CLK Source

PLL\_D2\_CLK is half the PLL\_CLK frequency.

### 3.2.4.6 Clock Source Considerations

Most peripherals will operate using the APB\_CLK frequency as a reference. When this frequency changes, the peripherals will need to update their clock configuration to operate at the same frequency after the change. Peripherals accessing REF\_TICK can continue operating normally when switching clock sources, without changing clock source. Please see Table 3-4 for details.

The LED PWM module can use RC\_FAST\_CLK as a clock source when APB\_CLK is disabled. In other words, when the system is in low-power consumption mode (see [Power Management Chapter](#)), normal peripherals will be halted (APB\_CLK is turned off), but the LED PWM can work normally via RC\_FAST\_CLK.

## 3.2.5 Wi-Fi BT Clock

Wi-Fi and BT can only operate if APB\_CLK uses PLL\_CLK as its clock source. Suspending PLL\_CLK requires Wi-Fi and BT to both have entered low-power consumption mode first.

For LOW\_POWER\_CLK, one of RC\_SLOW\_CLK, [RTC\\_SLOW\\_CLK](#), RC\_FAST\_CLK or XTL\_CLK can be selected as the low-power consumption mode clock source for Wi-Fi and BT.

### 3.2.6 RTC Clock

The clock sources of RTC\_SLOW\_CLK and RTC\_FAST\_CLK are low-frequency clocks. The RTC module can operate when most other clocks are stopped.

RTC\_SLOW\_CLK is used to clock the Power Management module. It can be sourced from RC\_SLOW\_CLK, XTL32K\_CLK or RC\_FAST\_DIV\_CLK.

RTC\_FAST\_CLK is used to clock the On-chip Sensor module. It can be sourced from a divided XTL\_CLK or from RC\_FAST\_CLK.

### 3.2.7 Audio PLL

The operation of audio and other time-critical data-transfer applications requires highly-configurable, low-jitter, and accurate clock sources. The clock sources derived from system clocks that serve digital peripherals may carry jitter and, therefore, they do not support a high-precision clock frequency setting.

Providing an integrated precision clock source can minimize system cost. To this end, ESP32 integrates an audio PLL. The Audio PLL formula is as follows:

$$f_{\text{out}} = \frac{f_{\text{xtal}}(\text{sdm2} + \frac{\text{sdm1}}{2^8} + \frac{\text{sdm0}}{2^{16}} + 4)}{2(\text{odiv} + 2)}$$

The parameters of this formula are defined below:

- $f_{\text{xtal}}$ : the frequency of the crystal oscillator, usually 40 MHz;
- sdm0: the value is 0 ~ 255;
- sdm1: the value is 0 ~ 255;
- sdm2: the value is 0 ~ 63;
- odiv: the value is 0 ~ 31;

The operating frequency range of the numerator is 350 MHz ~ 500 MHz:

$$350\text{MHz} < f_{\text{xtal}}(\text{sdm2} + \frac{\text{sdm1}}{2^8} + \frac{\text{sdm0}}{2^{16}} + 4) < 500\text{MHz}$$

Please note that sdm1 and sdm0 are not available on revision0 of ESP32. Please consult the silicon revision in [ECO and Workarounds for Bugs in ESP32](#) for further details.

Audio PLL can be manually enabled or disabled via registers RTC\_CNTL\_PLLA\_FORCE\_PU and RTC\_CNTL\_PLLA\_FORCE\_PD, respectively. Disabling it takes priority over enabling it. When RTC\_CNTL\_PLLA\_FORCE\_PU and RTC\_CNTL\_PLLA\_FORCE\_PD are 0, PLL will follow the state of the system, i.e., when the system enters sleep mode, PLL will be disabled automatically; when the system wakes up, PLL will be enabled automatically.

## 4 IO\_MUX and GPIO Matrix (GPIO, IO\_MUX)

### 4.1 Overview

The ESP32 chip features 34 physical GPIO pads. Each pad can be used as a general-purpose I/O, or be connected to an internal peripheral signal. The IO\_MUX, RTC IO\_MUX and the GPIO matrix are responsible for routing signals from the peripherals to GPIO pads. Together these systems provide highly configurable I/O.

**Note that the I/O GPIO pads are 0-19, 21-23, 25-27, 32-39, while the output GPIOs are 0-19, 21-23, 25-27, 32-33. GPIO pads 34-39 are input-only.**

This chapter describes the signal selection and connection between the digital pads (FUN\_SEL, IE, OE, WPU, WDU, etc.), 162 peripheral input and 176 output signals (control signals: SIG\_IN\_SEL, SIG\_OUT\_SEL, IE, OE, etc.), fast peripheral input/output signals (control signals: IE, OE, etc.), and RTC IO\_MUX.

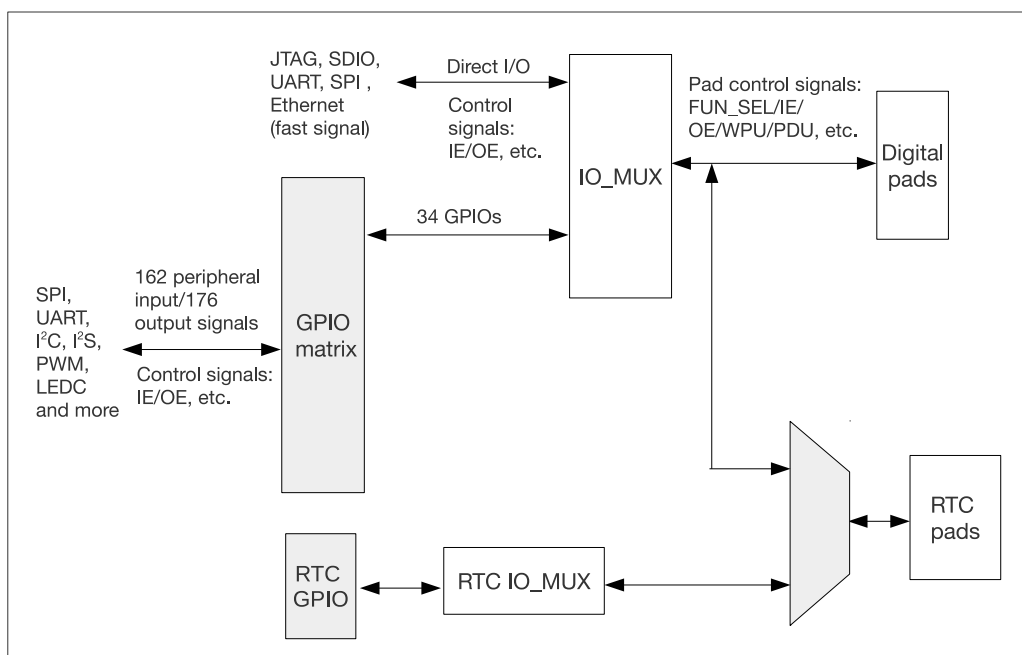


Figure 4-1. IO\_MUX, RTC IO\_MUX and GPIO Matrix Overview

1. The IO\_MUX contains one register per GPIO pad. Each pad can be configured to perform a "GPIO" function (when connected to the GPIO Matrix) or a direct function (bypassing the GPIO Matrix). Some high-speed digital functions (Ethernet, SDIO, SPI, JTAG, UART) can bypass the GPIO Matrix for better high-frequency digital performance. In this case, the IO\_MUX is used to connect these pads directly to the peripheral.)

See Section 4.10 for a list of IO\_MUX functions for each I/O pad.

2. The GPIO Matrix is a full-switching matrix between the peripheral input/output signals and the pads.
  - For input to the chip: Each of the 162 internal peripheral inputs can select any GPIO pad as the input source.
  - For output from the chip: The output signal of each of the 34 GPIO pads can be from one of the 176 peripheral output signals.

See Section 4.9 for a list of GPIO Matrix peripheral signals.

3. RTC IO\_MUX is used to connect GPIO pads to their low-power and analog functions. Only a subset of GPIO pads have these optional "RTC" functions.

See Section 4.11 for a list of RTC IO\_MUX functions.

## 4.2 Peripheral Input via GPIO Matrix

### 4.2.1 Summary

To receive a peripheral input signal via the GPIO Matrix, the GPIO Matrix is configured to source the peripheral signal's input index (0-18, 23-36, 39-58, 61-90, 95-124, 140-155, 164-181, 190-195, 198-206) from one of the 34 GPIOs (0-19, 21-23, 25-27, 32-39).

The input signal is read from the GPIO pad through the IO\_MUX. The IO\_MUX must be configured to set the chosen pad to "GPIO" function. This causes the GPIO pad input signal to be routed into the GPIO Matrix, which in turn routes it to the selected peripheral input.

### 4.2.2 Functional Description

Figure 4-2 shows the logic for input selection via GPIO Matrix.

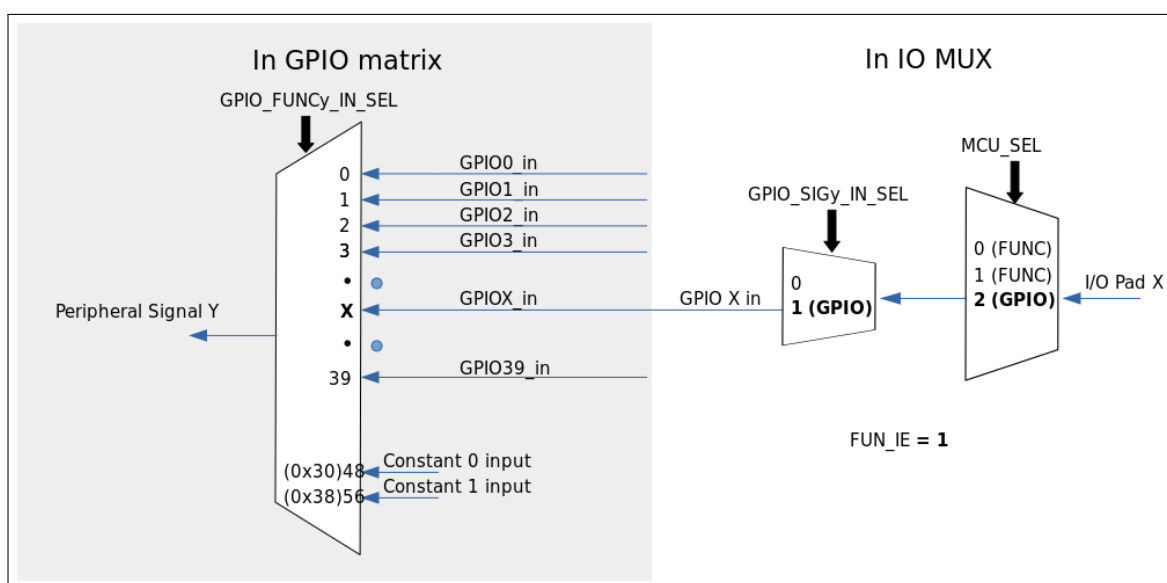


Figure 4-2. Peripheral Input via IO\_MUX, GPIO Matrix

To read GPIO pad  $X$  into peripheral signal  $Y$ , follow the steps below:

1. Configure the `GPIO_FUNCy_IN_SEL_CFG` register corresponding to peripheral signal  $Y$  in the GPIO Matrix:
  - Set `GPIO_SIGy_IN_SEL` to enable peripheral signal input via GPIO matrix.
  - Set the `GPIO_FUNCy_IN_SEL` field in this register, corresponding to the GPIO pad  $X$  to read from.
2. Configure the `GPIO_FUNCx_OUT_SEL_CFG` register and clear the `GPIO_ENABLE_DATA[x]` field corresponding to GPIO pad  $X$  in the GPIO Matrix:
  - Set the `GPIO_FUNCx_OEN_SEL` bit in the `GPIO_FUNCx_OUT_SEL_CFG` register to force the pin's output state to be determined always by the `GPIO_ENABLE_DATA[x]` field.
  - The `GPIO_ENABLE_DATA[x]` field is a bit in either `GPIO_ENABLE_REG` (GPIOs 0-31) or `GPIO_ENABLE1_REG` (GPIOs 32-39). Clear this bit to disable the output driver for the GPIO pad.

- Configure the IO\_MUX to select the GPIO Matrix. Set the IO\_MUX\_x\_REG register corresponding to GPIO pad X as follows:
  - Set the function field (MCU\_SEL) to the IO\_MUX function corresponding to GPIO X (this is Function 2—numeric value 2—for all pins).
  - Enable the input by setting the FUN\_IE bit.
  - Set or clear the FUN\_WPU and FUN\_WPD bits, as desired, to enable/disable internal pull-up/pull-down resistors.

**Notes:**

- One input pad can be connected to multiple input\_signals.
- The input signal can be inverted with GPIO\_FUNCy\_IN\_INV\_SEL.
- It is possible to have a peripheral read a constantly low or constantly high input value without connecting this input to a pad. This can be done by selecting a special GPIO\_FUNCy\_IN\_SEL input, instead of a GPIO number:
  - When GPIO\_FUNCy\_IN\_SEL is 0x30, input\_signal\_x is always 0.
  - When GPIO\_FUNCy\_IN\_SEL is 0x38, input\_signal\_x is always 1.

For example, to connect RMT peripheral channel 0 input signal (RMT\_SIG\_IN0\_IDX, signal index 83) to GPIO 15, please follow the steps below. Note that GPIO 15 is also named the MTDO pin:

- Set the GPIO\_FUNC83\_IN\_SEL\_CFG register field GPIO\_FUNC83\_IN\_SEL value to 15.
- As this is an input-only signal, set GPIO\_FUNC15\_OEN\_SEL bit in GPIO\_FUNC15\_OUT\_SEL\_CFG\_REG.
- Clear bit 15 of GPIO\_ENABLE\_REG (field GPIO\_ENABLE\_DATA[15]).
- Set the IO\_MUX\_GPIO15 register MCU\_SEL field to 2 (GPIO function) and also set the FUN\_IE bit (input mode).

### 4.2.3 Simple GPIO Input

The GPIO\_IN\_REG/GPIO\_IN1\_REG register holds the input values of each GPIO pad.

The input value of any GPIO pin can be read at any time without configuring the GPIO Matrix for a particular peripheral signal. However, it is necessary to enable the input in the IO\_MUX by setting the FUN\_IE bit in the IO\_MUX\_x\_REG register corresponding to pad X, as mentioned in Section 4.2.2.

## 4.3 Peripheral Output via GPIO Matrix

### 4.3.1 Summary

To output a signal from a peripheral via the GPIO Matrix, the GPIO Matrix is configured to route the peripheral output signal (0-18, 23-37, 61-121, 140-125, 224-228) to one of the 28 GPIOs (0-19, 21-23, 25-27, 32-33).

The output signal is routed from the peripheral into the GPIO Matrix. It is then routed into the IO\_MUX, which is configured to set the chosen pad to "GPIO" function. This causes the output GPIO signal to be connected to the pad.

**Note:**

The peripheral output signals 224 to 228 can be configured to be routed in from one GPIO and output directly from another GPIO.

### 4.3.2 Functional Description

One of the 176 output signals can be selected to go through the GPIO matrix into the IO\_MUX and then to a pad. Figure 4-3 illustrates the configuration.

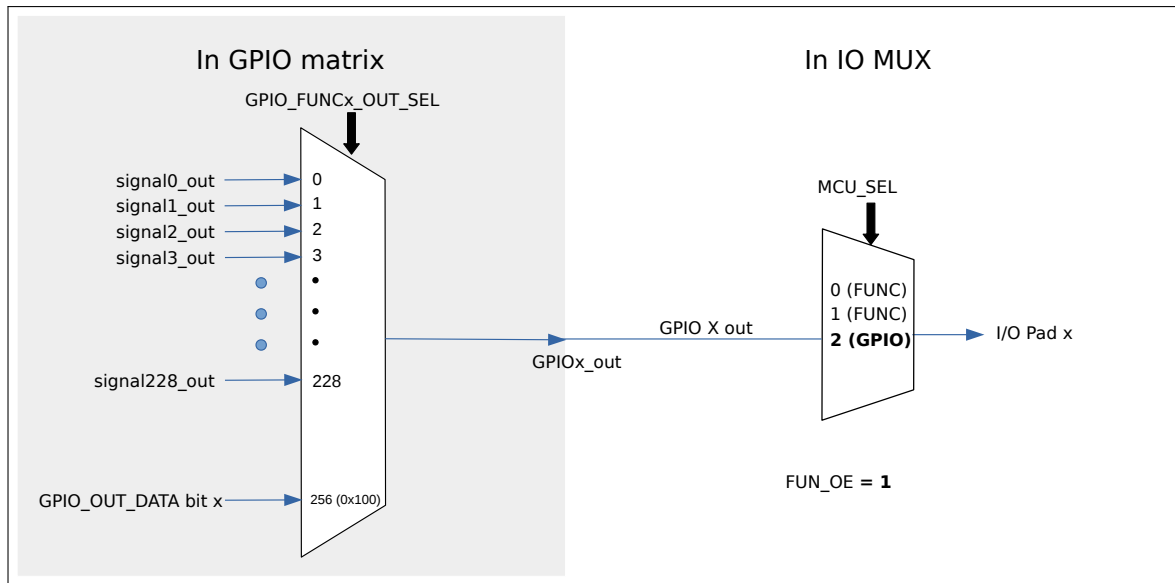


Figure 4-3. Output via GPIO Matrix

To output peripheral signal  $Y$  to particular GPIO pad  $X$ , follow these steps:

- Configure the `GPIO_FUNC $x$ _OUT_SEL_CFG` register and `GPIO_ENABLE_DATA[ $x$ ]` field corresponding to GPIO  $X$  in the GPIO Matrix:
  - Set the `GPIO_FUNC $x$ _OUT_SEL` field in `GPIO_FUNC $x$ _OUT_SEL_CFG` to the numeric index ( $Y$ ) of desired peripheral output signal  $Y$ .
  - If the signal should always be enabled as an output, set the `GPIO_FUNC $x$ _OEN_SEL` bit in the `GPIO_FUNC $x$ _OUT_SEL_CFG` register and the `GPIO_ENABLE_DATA[ $x$ ]` field in the `GPIO_ENABLE_REG` register corresponding to GPIO pad  $X$ . To have the output enable signal decided by internal logic, clear the `GPIO_FUNC $x$ _OEN_SEL` bit instead.
  - The `GPIO_ENABLE_DATA[ $x$ ]` field is a bit in either `GPIO_ENABLE_REG` (GPIOs 0-31) or `GPIO_ENABLE1_REG` (GPIOs 32-39). Clear this bit to disable the output driver for the GPIO pad.
- For an open drain output, set the `GPIO_PIN $x$ _PAD_DRIVER` bit in the `GPIO_PIN $x$`  register corresponding to GPIO pad  $X$ . For push/pull mode (default), clear this bit.
- Configure the IO\_MUX to select the GPIO Matrix. Set the `IO_MUX_ $x$ _REG` register corresponding to GPIO pad  $X$  as follows:
  - Set the function field (`MCU_SEL`) to the IO\_MUX function corresponding to GPIO  $X$  (this is Function 2—numeric value 2—for all pins).
  - Set the `FUN_DRV` field to the desired value for output strength (0-3). The higher the drive strength, the more current can be sourced/sunk from the pin.
  - If using open drain mode, set/clear the `FUN_WPU` and `FUN_WPD` bits to enable/disable the internal pull-up/down resistors.



**Notes:**

- The output signal from a single peripheral can be sent to multiple pads simultaneously.
- Only the 28 GPIOs can be used as outputs.
- The output signal can be inverted by setting the GPIO\_FUNC $x$ \_OUT\_INV\_SEL bit.

### 4.3.3 Simple GPIO Output

The GPIO Matrix can also be used for simple GPIO output – setting a bit in the GPIO\_OUT\_DATA register will write to the corresponding GPIO pad.

To configure a pad as simple GPIO output, the GPIO Matrix GPIO\_FUNC $x$ \_OUT\_SEL register is configured with a special peripheral index value (0x100).

## 4.4 Direct I/O via IO\_MUX

### 4.4.1 Summary

Some high speed digital functions (Ethernet, SDIO, SPI, JTAG, UART) can bypass the GPIO Matrix for better high-frequency digital performance. In this case, the IO\_MUX is used to connect these pads directly to the peripheral.

Selecting this option is less flexible than using the GPIO Matrix, as the IO\_MUX register for each GPIO pad can only select from a limited number of functions. However, better high-frequency digital performance will be maintained.

### 4.4.2 Functional Description

Two registers must be configured in order to bypass the GPIO Matrix for peripheral I/O:

1. IO\_MUX for the GPIO pad must be set to the required pad function. (Please refer to section 4.10 for a list of pad functions.)
2. For inputs, the SIG\_IN\_SEL register must be cleared to route the input directly to the peripheral.

## 4.5 RTC IO\_MUX for Low Power and Analog I/O

### 4.5.1 Summary

18 GPIO pads have low power capabilities (RTC domain) and analog functions which are handled by the RTC subsystem of ESP32. The IO\_MUX and GPIO Matrix are not used for these functions; rather, the RTC\_MUX is used to redirect the I/O to the RTC subsystem.

When configured as RTC GPIOs, the output pads can still retain the output level value when the chip is in Deep-sleep mode, and the input pads can wake up the chip from Deep-sleep.

Section 4.11 has a list of RTC\_MUX pins and their functions.

### 4.5.2 Functional Description

Each pad with analog and RTC functions is controlled by the RTC\_IO\_TOUCH\_PAD $x$ \_TO\_GPIO bit in the RTC\_GPIO\_PIN $x$  register. By default this bit is set to 1, routing all I/O via the IO\_MUX subsystem as described in earlier subsections.

If the RTC\_IO\_TOUCH\_PAD $x$ \_TO\_GPIO bit is cleared, then I/O to and from that pad is routed to the RTC subsystem. In this mode, the RTC\_GPIO\_PIN $x$  register is used for digital I/O and the analog features of the pad are also

available. See Section 4.11 for a list of RTC pin functions.

See 4.11 for a table mapping GPIO pads to their RTC equivalent pins and analog functions. Note that the RTC\_IO\_PINx registers use the RTC GPIO pin numbering, not the GPIO pad numbering.

## 4.6 Light-sleep Mode Pin Functions

Pins can have different functions when the ESP32 is in Light-sleep mode. If the SLP\_SEL bit in the IO\_MUX register for a GPIO pad is set to 1, a different set of registers is used to control the pad when the ESP32 is in Light-sleep mode:

**Table 4-1. IO\_MUX Light-sleep Pin Function Registers**

IO_MUX Function	Normal Execution OR SLP_SEL = 0	Light-sleep Mode AND SLP_SEL = 1
Output Drive Strength	FUN_DRV	MCU_DRV
Pull-up Resistor	FUN_WPU	MCU_WPU
Pull-down Resistor	FUN_WPD	MCU_WPD
Output Enable	(From GPIO Matrix _OEN field)	MCU_OE

If SLP\_SEL is set to 0, the pin functions remain the same in both normal execution and Light-sleep mode.

## 4.7 Pad Hold Feature

Each IO pad (including the RTC pads) has an individual hold function controlled by a RTC register. When the pad is set to hold, the state is latched at that moment and will not change no matter how the internal signals change or how the IO\_MUX configuration or GPIO configuration is modified. Users can use the hold function for the pads to retain the pad state through a core reset and system reset triggered by watchdog time-out or Deep-sleep events.

### Note:

- For digital pads, to maintain the pad's input/output status in Deep-sleep mode, you can set REG\_DG\_PAD\_FORCE\_UNHOLD to 0 before powering down.  
For RTC pads, the input and output values are controlled by the corresponding bits of register RTC\_CNTL\_HOLD\_FORCE\_REG, and you can set it to 1 to hold the value or set it to 0 to unhold the value.
- For digital pads, to disable the hold function after the chip is woken up, you can set REG\_DG\_PAD\_FORCE\_UNHOLD to 1. To maintain the hold function of the pad, you can change the corresponding bit in the register by setting RTC\_CNTL\_HOLD\_FORCE\_REG to 1.

## 4.8 I/O Pad Power Supplies

Figure 4-4 and 4-5 show the IO pad power supplies.

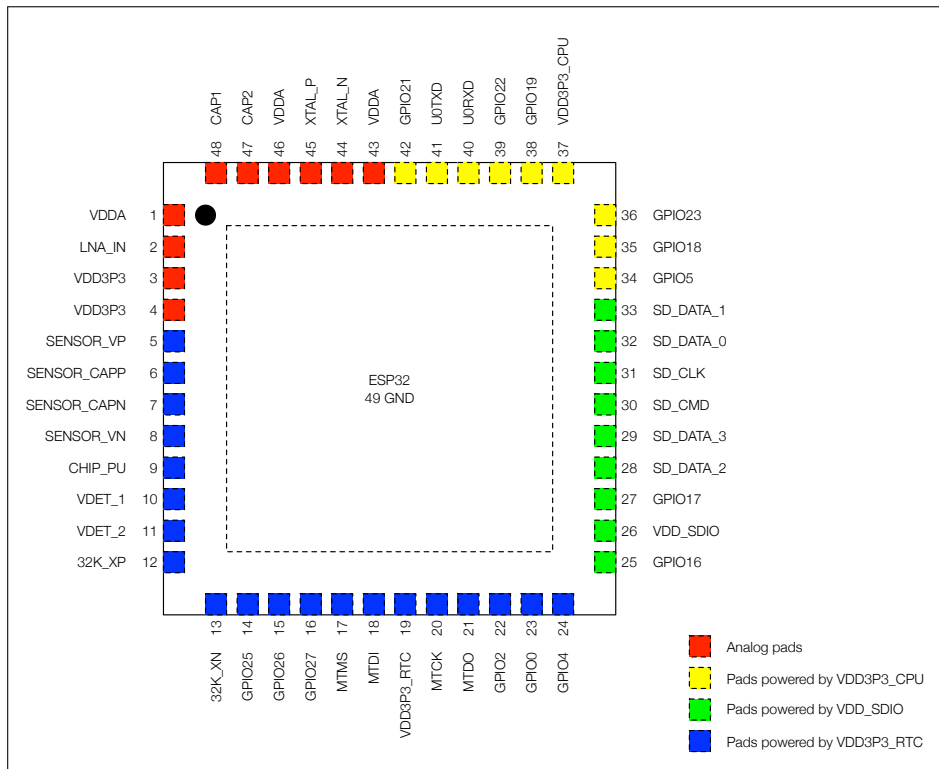


Figure 4-4. ESP32 I/O Pad Power Sources (QFN 6\*6, Top View)

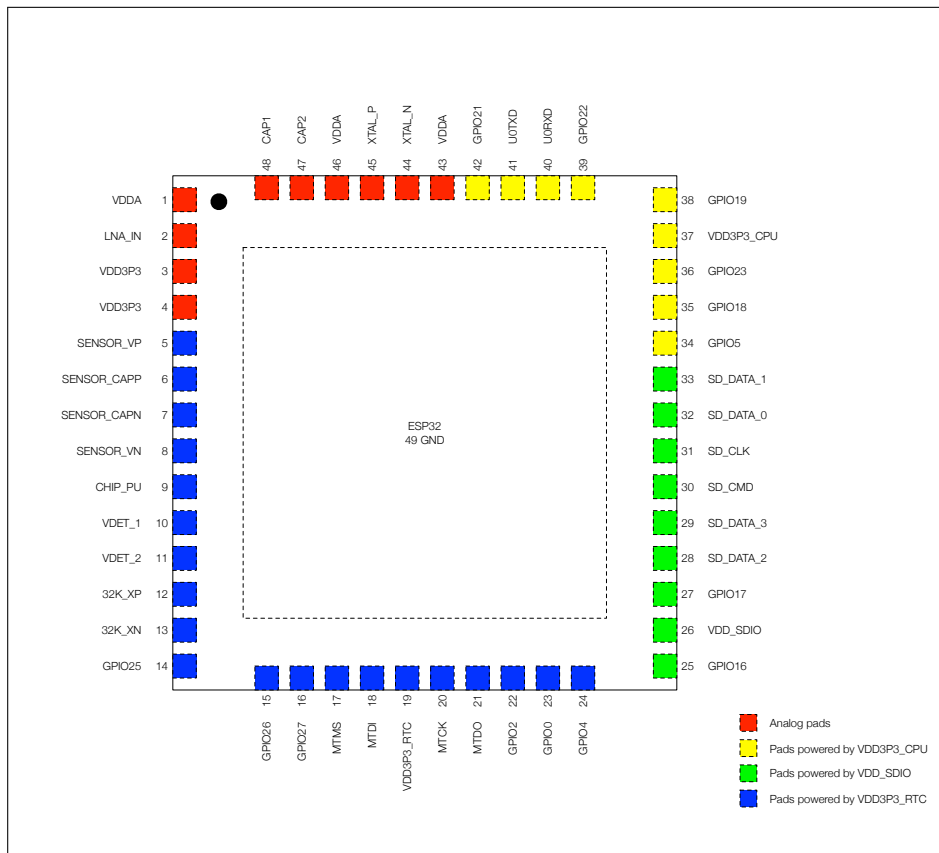


Figure 4-5. ESP32 I/O Pad Power Sources (QFN 5\*5, Top View)

- Pads marked blue are RTC pads that have their individual analog function and can also act as normal digital

IO pads. For details, please see Section 4.11.

- Pads marked yellow and green have digital functions only.
- Pads marked green can be powered externally or internally via VDD\_SDIO (see below).

#### 4.8.1 VDD\_SDIO Power Domain

VDD\_SDIO can source or sink current, allowing this power domain to be powered externally or internally. To power VDD\_SDIO externally, apply the same power supply of VDD3P3\_RTC to the VDD\_SDIO pad.

Without an external power supply, the internal regulator will supply VDD\_SDIO. The VDD\_SDIO voltage can be configured to be either 1.8V or the same as VDD3P3\_RTC, depending on the state of the MTDI pad at reset – a high level configures 1.8V and a low level configures the voltage to be the same as VDD3P3\_RTC. Setting the efuse bit determines the default voltage of the VDD\_SDIO. In addition, software can change the voltage of the VDD\_SDIO by configuring register bits.

## 4.9 Peripheral Signal List

Table 4-2 contains a list of Peripheral Input/Output signals used by the GPIO Matrix:

**Table 4-2. GPIO Matrix Peripheral Signals**

Signal	Input Signal	Output Signal	Direct I/O in IO_MUX
0	SPICLK_in	SPICLK_out	YES
1	SPIQ_in	SPIQ_out	YES
2	SPID_in	SPID_out	YES
3	SPIHD_in	SPIHD_out	YES
4	SPIWP_in	SPIWP_out	YES
5	SPICS0_in	SPICS0_out	YES
6	SPICS1_in	SPICS1_out	-
7	SPICS2_in	SPICS2_out	-
8	HSPICLK_in	HSPICLK_out	YES
9	HSPIQ_in	HSPIQ_out	YES
10	HSPID_in	HSPID_out	YES
11	HSPICS0_in	HSPICS0_out	YES
12	HSPIHD_in	HSPIHD_out	YES
13	HSPIWP_in	HSPIWP_out	YES
14	U0RXD_in	U0TXD_out	YES
15	U0CTS_in	U0RTS_out	YES
16	U0DSR_in	U0DTR_out	-
17	U1RXD_in	U1TXD_out	YES
18	U1CTS_in	U1RTS_out	YES
23	I2S0O_BCK_in	I2S0O_BCK_out	-
24	I2S1O_BCK_in	I2S1O_BCK_out	-
25	I2S0O_WS_in	I2S0O_WS_out	-
26	I2S1O_WS_in	I2S1O_WS_out	-
27	I2S0I_BCK_in	I2S0I_BCK_out	-
28	I2S0I_WS_in	I2S0I_WS_out	-

Signal	Input Signal	Output Signal	Direct I/O in IO_MUX
29	I2CEXT0_SCL_in	I2CEXT0_SCL_out	-
30	I2CEXT0_SDA_in	I2CEXT0_SDA_out	-
31	pwm0_sync0_in	sdio_tohost_int_out	-
32	pwm0_sync1_in	pwm0_out0a	-
33	pwm0_sync2_in	pwm0_out0b	-
34	pwm0_f0_in	pwm0_out1a	-
35	pwm0_f1_in	pwm0_out1b	-
36	pwm0_f2_in	pwm0_out2a	-
37	-	pwm0_out2b	-
39	pcnt_sig_ch0_in0	-	-
40	pcnt_sig_ch1_in0	-	-
41	pcnt_ctrl_ch0_in0	-	-
42	pcnt_ctrl_ch1_in0	-	-
43	pcnt_sig_ch0_in1	-	-
44	pcnt_sig_ch1_in1	-	-
45	pcnt_ctrl_ch0_in1	-	-
46	pcnt_ctrl_ch1_in1	-	-
47	pcnt_sig_ch0_in2	-	-
48	pcnt_sig_ch1_in2	-	-
49	pcnt_ctrl_ch0_in2	-	-
50	pcnt_ctrl_ch1_in2	-	-
51	pcnt_sig_ch0_in3	-	-
52	pcnt_sig_ch1_in3	-	-
53	pcnt_ctrl_ch0_in3	-	-
54	pcnt_ctrl_ch1_in3	-	-
55	pcnt_sig_ch0_in4	-	-
56	pcnt_sig_ch1_in4	-	-
57	pcnt_ctrl_ch0_in4	-	-
58	pcnt_ctrl_ch1_in4	-	-
61	HSPICS1_in	HSPICS1_out	-
62	HSPICS2_in	HSPICS2_out	-
63	VSPICLK_in	VSPICLK_out_mux	YES
64	VSPIQ_in	VSPIQ_out	YES
65	VSPID_in	VSPID_out	YES
66	VSPICHD_in	VSPICHD_out	YES
67	VSPICWP_in	VSPICWP_out	YES
68	VSPICS0_in	VSPICS0_out	YES
69	VSPICS1_in	VSPICS1_out	-
70	VSPICS2_in	VSPICS2_out	-
71	pcnt_sig_ch0_in5	ledc_hs_sig_out0	-
72	pcnt_sig_ch1_in5	ledc_hs_sig_out1	-
73	pcnt_ctrl_ch0_in5	ledc_hs_sig_out2	-
74	pcnt_ctrl_ch1_in5	ledc_hs_sig_out3	-

Signal	Input Signal	Output Signal	Direct I/O in IO_MUX
75	pcnt_sig_ch0_in6	ledc_hs_sig_out4	-
76	pcnt_sig_ch1_in6	ledc_hs_sig_out5	-
77	pcnt_ctrl_ch0_in6	ledc_hs_sig_out6	-
78	pcnt_ctrl_ch1_in6	ledc_hs_sig_out7	-
79	pcnt_sig_ch0_in7	ledc_ls_sig_out0	-
80	pcnt_sig_ch1_in7	ledc_ls_sig_out1	-
81	pcnt_ctrl_ch0_in7	ledc_ls_sig_out2	-
82	pcnt_ctrl_ch1_in7	ledc_ls_sig_out3	-
83	rmt_sig_in0	ledc_ls_sig_out4	-
84	rmt_sig_in1	ledc_ls_sig_out5	-
85	rmt_sig_in2	ledc_ls_sig_out6	-
86	rmt_sig_in3	ledc_ls_sig_out7	-
87	rmt_sig_in4	rmt_sig_out0	-
88	rmt_sig_in5	rmt_sig_out1	-
89	rmt_sig_in6	rmt_sig_out2	-
90	rmt_sig_in7	rmt_sig_out3	-
91	-	rmt_sig_out4	-
92	-	rmt_sig_out5	-
93	-	rmt_sig_out6	-
94	-	rmt_sig_out7	-
95	I2CEXT1_SCL_in	I2CEXT1_SCL_out	-
96	I2CEXT1_SDA_in	I2CEXT1_SDA_out	-
97	host_card_detect_n_1	host_ccmd_od_pullup_en_n	-
98	host_card_detect_n_2	host_rst_n_1	-
99	host_card_write_prt_1	host_rst_n_2	-
100	host_card_write_prt_2	gpio_sd0_out	-
101	host_card_int_n_1	gpio_sd1_out	-
102	host_card_int_n_2	gpio_sd2_out	-
103	pwm1_sync0_in	gpio_sd3_out	-
104	pwm1_sync1_in	gpio_sd4_out	-
105	pwm1_sync2_in	gpio_sd5_out	-
106	pwm1_f0_in	gpio_sd6_out	-
107	pwm1_f1_in	gpio_sd7_out	-
108	pwm1_f2_in	pwm1_out0a	-
109	pwm0_cap0_in	pwm1_out0b	-
110	pwm0_cap1_in	pwm1_out1a	-
111	pwm0_cap2_in	pwm1_out1b	-
112	pwm1_cap0_in	pwm1_out2a	-
113	pwm1_cap1_in	pwm1_out2b	-
114	pwm1_cap2_in	-	-
115	-	-	-
116	-	-	-
117	-	-	-

Signal	Input Signal	Output Signal	Direct I/O in IO_MUX
118	-	-	-
119	-	-	-
120	-	-	-
121	-	-	-
122	-	-	-
123	-	-	-
124	-	-	-
140	I2S0I_DATA_in0	I2S0O_DATA_out0	-
141	I2S0I_DATA_in1	I2S0O_DATA_out1	-
142	I2S0I_DATA_in2	I2S0O_DATA_out2	-
143	I2S0I_DATA_in3	I2S0O_DATA_out3	-
144	I2S0I_DATA_in4	I2S0O_DATA_out4	-
145	I2S0I_DATA_in5	I2S0O_DATA_out5	-
146	I2S0I_DATA_in6	I2S0O_DATA_out6	-
147	I2S0I_DATA_in7	I2S0O_DATA_out7	-
148	I2S0I_DATA_in8	I2S0O_DATA_out8	-
149	I2S0I_DATA_in9	I2S0O_DATA_out9	-
150	I2S0I_DATA_in10	I2S0O_DATA_out10	-
151	I2S0I_DATA_in11	I2S0O_DATA_out11	-
152	I2S0I_DATA_in12	I2S0O_DATA_out12	-
153	I2S0I_DATA_in13	I2S0O_DATA_out13	-
154	I2S0I_DATA_in14	I2S0O_DATA_out14	-
155	I2S0I_DATA_in15	I2S0O_DATA_out15	-
156	-	I2S0O_DATA_out16	-
157	-	I2S0O_DATA_out17	-
158	-	I2S0O_DATA_out18	-
159	-	I2S0O_DATA_out19	-
160	-	I2S0O_DATA_out20	-
161	-	I2S0O_DATA_out21	-
162	-	I2S0O_DATA_out22	-
163	-	I2S0O_DATA_out23	-
164	I2S1I_BCK_in	I2S1I_BCK_out	-
165	I2S1I_WS_in	I2S1I_WS_out	-
166	I2S1I_DATA_in0	I2S1O_DATA_out0	-
167	I2S1I_DATA_in1	I2S1O_DATA_out1	-
168	I2S1I_DATA_in2	I2S1O_DATA_out2	-
169	I2S1I_DATA_in3	I2S1O_DATA_out3	-
170	I2S1I_DATA_in4	I2S1O_DATA_out4	-
171	I2S1I_DATA_in5	I2S1O_DATA_out5	-
172	I2S1I_DATA_in6	I2S1O_DATA_out6	-
173	I2S1I_DATA_in7	I2S1O_DATA_out7	-
174	I2S1I_DATA_in8	I2S1O_DATA_out8	-
175	I2S1I_DATA_in9	I2S1O_DATA_out9	-

Signal	Input Signal	Output Signal	Direct I/O in IO_MUX
176	I2S1I_DATA_in10	I2S1O_DATA_out10	-
177	I2S1I_DATA_in11	I2S1O_DATA_out11	-
178	I2S1I_DATA_in12	I2S1O_DATA_out12	-
179	I2S1I_DATA_in13	I2S1O_DATA_out13	-
180	I2S1I_DATA_in14	I2S1O_DATA_out14	-
181	I2S1I_DATA_in15	I2S1O_DATA_out15	-
182	-	I2S1O_DATA_out16	-
183	-	I2S1O_DATA_out17	-
184	-	I2S1O_DATA_out18	-
185	-	I2S1O_DATA_out19	-
186	-	I2S1O_DATA_out20	-
187	-	I2S1O_DATA_out21	-
188	-	I2S1O_DATA_out22	-
189	-	I2S1O_DATA_out23	-
190	I2S0I_H_SYNC	-	-
191	I2S0I_V_SYNC	-	-
192	I2S0I_H_ENABLE	-	-
193	I2S1I_H_SYNC	-	-
194	I2S1I_V_SYNC	-	-
195	I2S1I_H_ENABLE	-	-
196	-	-	-
197	-	-	-
198	U2RXD_in	U2TXD_out	YES
199	U2CTS_in	U2RTS_out	YES
200	emac_mdc_i	emac_mdc_o	-
201	emac_mdi_i	emac_mdo_o	-
202	emac_crs_i	emac_crs_o	-
203	emac_col_i	emac_col_o	-
204	pcmfsync_in	bt_audio0_irq	-
205	pcmclk_in	bt_audio1_irq	-
206	pcmdin	bt_audio2_irq	-
207	-	ble_audio0_irq	-
208	-	ble_audio1_irq	-
209	-	ble_audio2_irq	-
210	-	pcmfsync_out	-
211	-	pcmclk_out	-
212	-	pcmdout	-
213	-	ble_audio_sync0_p	-
214	-	ble_audio_sync1_p	-
215	-	ble_audio_sync2_p	-
224	-	sig_in_func224	-
225	-	sig_in_func225	-
226	-	sig_in_func226	-



Signal	Input Signal	Output Signal	Direct I/O in IO_MUX
227	-	sig_in_func227	-
228	-	sig_in_func228	-

**Direct I/O in IO\_MUX "YES"** means that this signal is also available directly via IO\_MUX. To apply the GPIO Matrix to these signals, their corresponding SIG\_IN\_SEL register must be cleared.

## 4.10 IO\_MUX Pad List

Table 4-3 shows the IO\_MUX functions for each I/O pad:

**Table 4-3. IO\_MUX Pad Summary**

GPIO	Pad Name	Function 0	Function 1	Function 2	Function 3	Function 4	Function 5	Reset	Notes
0	GPIO0	GPIO0	CLK_OUT1	GPIO0	-	-	EMAC_TX_CLK	3	R
1	U0TXD	U0TXD	CLK_OUT3	GPIO1	-	-	EMAC_RXD2	3	-
2	GPIO2	GPIO2	HSPIWP	GPIO2	HS2_DATA0	SD_DATA0	-	2	R
3	U0RXD	U0RXD	CLK_OUT2	GPIO3	-	-	-	3	-
4	GPIO4	GPIO4	HSPIHD	GPIO4	HS2_DATA1	SD_DATA1	EMAC_TX_ER	2	R
5	GPIO5	GPIO5	VSPICS0	GPIO5	HS1_DATA6	-	EMAC_RX_CLK	3	-
6	SD_CLK	SD_CLK	SPICLK	GPIO6	HS1_CLK	U1CTS	-	3	-
7	SD_DATA_0	SD_DATA0	SPIQ	GPIO7	HS1_DATA0	U2RTS	-	3	-
8	SD_DATA_1	SD_DATA1	SPID	GPIO8	HS1_DATA1	U2CTS	-	3	-
9	SD_DATA_2	SD_DATA2	SPIHD	GPIO9	HS1_DATA2	U1RXD	-	3	-
10	SD_DATA_3	SD_DATA3	SPIWP	GPIO10	HS1_DATA3	U1TXD	-	3	-
11	SD_CMD	SD_CMD	SPICS0	GPIO11	HS1_CMD	U1RTS	-	3	-
12	MTDI	MTDI	HSPIQ	GPIO12	HS2_DATA2	SD_DATA2	EMAC_TXD3	2	R
13	MTCK	MTCK	HSPID	GPIO13	HS2_DATA3	SD_DATA3	EMAC_RX_ER	2	R
14	MTMS	MTMS	HSPICLK	GPIO14	HS2_CLK	SD_CLK	EMAC_TXD2	3	R
15	MTDO	MTDO	HSPICS0	GPIO15	HS2_CMD	SD_CMD	EMAC_RXD3	3	R
16	GPIO16	GPIO16	-	GPIO16	HS1_DATA4	U2RXD	EMAC_CLK_OUT	1	-
17	GPIO17	GPIO17	-	GPIO17	HS1_DATA5	U2TXD	EMAC_CLK_180	1	-
18	GPIO18	GPIO18	VSPICLK	GPIO18	HS1_DATA7	-	-	1	-
19	GPIO19	GPIO19	VSPIQ	GPIO19	U0CTS	-	EMAC_TXD0	1	-
21	GPIO21	GPIO21	VSPIHD	GPIO21	-	-	EMAC_TX_EN	1	-
22	GPIO22	GPIO22	VSPIWP	GPIO22	U0RTS	-	EMAC_TXD1	1	-
23	GPIO23	GPIO23	VSPIID	GPIO23	HS1_STROBE	-	-	1	-
25	GPIO25	GPIO25	-	GPIO25	-	-	EMAC_RXD0	0	R
26	GPIO26	GPIO26	-	GPIO26	-	-	EMAC_RXD1	0	R
27	GPIO27	GPIO27	-	GPIO27	-	-	EMAC_RX_DV	0	R
32	32K_XP	GPIO32	-	GPIO32	-	-	-	0	R
33	32K_XN	GPIO33	-	GPIO33	-	-	-	0	R
34	VDET_1	GPIO34	-	GPIO34	-	-	-	0	R, I
35	VDET_2	GPIO35	-	GPIO35	-	-	-	0	R, I
36	SENSOR_VP	GPIO36	-	GPIO36	-	-	-	0	R, I
37	SENSOR_CAPP	GPIO37	-	GPIO37	-	-	-	0	R, I
38	SENSOR_CAPN	GPIO38	-	GPIO38	-	-	-	0	R, I
39	SENSOR_VN	GPIO39	-	GPIO39	-	-	-	0	R, I

### Reset Configurations

"Reset" column shows each pad's default configurations after reset:

- **0** - IE=0 (input disabled).
- **1** - IE=1 (input enabled).

- **2** - IE=1, WPD=1 (input enabled, pull-down resistor).
- **3** - IE=1, WPU=1 (input enabled, pull-up resistor).

### Notes

- **R** - Pad has RTC/analog functions via RTC\_MUX.
- **I** - Pad can only be configured as input GPIO. These input-only pads do not feature an output driver or internal pull-up/pull-down circuitry.

Please refer to the ESP32 Pin Lists in [ESP32 Datasheet](#) for more details.

## 4.11 RTC\_MUX Pin List

Table 4-4 shows the RTC pins and how they correspond to GPIO pads:

**Table 4-4. RTC\_MUX Pin Summary**

RTC GPIO Num	GPIO Num	Pad Name	Analog Function			RTC Function	
			0	1	2	Function 0 (FUN_SEL = 0)	Function 1 (FUN_SEL = 3)
0	36	SENSOR_VP	ADC_H	ADC1_CH0	-	RTC_GPIO0	-
1	37	SENSOR_CAPP	ADC_H	ADC1_CH1	-	RTC_GPIO1	-
2	38	SENSOR_CAPN	ADC_H	ADC1_CH2	-	RTC_GPIO2	-
3	39	SENSOR_VN	ADC_H	ADC1_CH3	-	RTC_GPIO3	-
4	34	VDET_1	-	ADC1_CH6	-	RTC_GPIO4	-
5	35	VDET_2	-	ADC1_CH7	-	RTC_GPIO5	-
6	25	GPIO25	DAC_1	ADC2_CH8	-	RTC_GPIO6	-
7	26	GPIO26	DAC_2	ADC2_CH9	-	RTC_GPIO7	-
8	33	32K_XN	XTAL_32K_N	ADC1_CH5	TOUCH8	RTC_GPIO8	-
9	32	32K_XP	XTAL_32K_P	ADC1_CH4	TOUCH9	RTC_GPIO9	-
10	4	GPIO4	-	ADC2_CH0	TOUCH0	RTC_GPIO10	I2C_SCL*
11	0	GPIO0	-	ADC2_CH1	TOUCH1	RTC_GPIO11	I2C_SDA*
12	2	GPIO2	-	ADC2_CH2	TOUCH2	RTC_GPIO12	I2C_SCL*
13	15	MTDO	-	ADC2_CH3	TOUCH3	RTC_GPIO13	I2C_SDA*
14	13	MTCK	-	ADC2_CH4	TOUCH4	RTC_GPIO14	-
15	12	MTDI	-	ADC2_CH5	TOUCH5	RTC_GPIO15	-
16	14	MTMS	-	ADC2_CH6	TOUCH6	RTC_GPIO16	-
17	27	GPIO27	-	ADC2_CH7	TOUCH7	RTC_GPIO17	-

**Note:**

For more information on the configuration of sar\_i2c\_xx, see Section RTC I2C Controller in Chapter [30 ULP Coprocessor \(ULP\)](#).

## 4.12 Register Summary

### 4.12.1 GPIO Matrix Register Summary

Name	Description	Address	Access
GPIO_OUT_REG	GPIO 0-31 output register	0x3FF44004	R/W
GPIO_OUT_W1TS_REG	GPIO 0-31 output register_W1TS	0x3FF44008	WO
GPIO_OUT_W1TC_REG	GPIO 0-31 output register_W1TC	0x3FF4400C	WO
GPIO_OUT1_REG	GPIO 32-39 output register	0x3FF44010	R/W
GPIO_OUT1_W1TS_REG	GPIO 32-39 output bit set register	0x3FF44014	WO
GPIO_OUT1_W1TC_REG	GPIO 32-39 output bit clear register	0x3FF44018	WO
GPIO_ENABLE_REG	GPIO 0-31 output enable register	0x3FF44020	R/W
GPIO_ENABLE_W1TS_REG	GPIO 0-31 output enable register_W1TS	0x3FF44024	WO
GPIO_ENABLE_W1TC_REG	GPIO 0-31 output enable register_W1TC	0x3FF44028	WO
GPIO_ENABLE1_REG	GPIO 32-39 output enable register	0x3FF4402C	R/W
GPIO_ENABLE1_W1TS_REG	GPIO 32-39 output enable bit set register	0x3FF44030	WO
GPIO_ENABLE1_W1TC_REG	GPIO 32-39 output enable bit clear register	0x3FF44034	WO
GPIO_STRAP_REG	Bootstrap pin value register	0x3FF44038	RO
GPIO_IN_REG	GPIO 0-31 input register	0x3FF4403C	RO
GPIO_IN1_REG	GPIO 32-39 input register	0x3FF44040	RO
GPIO_STATUS_REG	GPIO 0-31 interrupt status register	0x3FF44044	R/W
GPIO_STATUS_W1TS_REG	GPIO 0-31 interrupt status register_W1TS	0x3FF44048	WO
GPIO_STATUS_W1TC_REG	GPIO 0-31 interrupt status register_W1TC	0x3FF4404C	WO
GPIO_STATUS1_REG	GPIO 32-39 interrupt status register1	0x3FF44050	R/W
GPIO_STATUS1_W1TS_REG	GPIO 32-39 interrupt status bit set register	0x3FF44054	WO
GPIO_STATUS1_W1TC_REG	GPIO 32-39 interrupt status bit clear register	0x3FF44058	WO
GPIO_ACPU_INT_REG	GPIO 0-31 APP_CPU interrupt status	0x3FF44060	RO
GPIO_ACPU_NMI_INT_REG	GPIO 0-31 APP_CPU non-maskable interrupt status	0x3FF44064	RO
GPIO_PCPU_INT_REG	GPIO 0-31 PRO_CPU interrupt status	0x3FF44068	RO
GPIO_PCPU_NMI_INT_REG	GPIO 0-31 PRO_CPU non-maskable interrupt status	0x3FF4406C	RO
GPIO_ACPU_INT1_REG	GPIO 32-39 APP_CPU interrupt status	0x3FF44074	RO
GPIO_ACPU_NMI_INT1_REG	GPIO 32-39 APP_CPU non-maskable interrupt status	0x3FF44078	RO
GPIO_PCPU_INT1_REG	GPIO 32-39 PRO_CPU interrupt status	0x3FF4407C	RO
GPIO_PCPU_NMI_INT1_REG	GPIO 32-39 PRO_CPU non-maskable interrupt status	0x3FF44080	RO
GPIO_PIN0_REG	Configuration for GPIO pin 0	0x3FF44088	R/W
GPIO_PIN1_REG	Configuration for GPIO pin 1	0x3FF4408C	R/W
GPIO_PIN2_REG	Configuration for GPIO pin 2	0x3FF44090	R/W
...	...		
GPIO_PIN38_REG	Configuration for GPIO pin 38	0x3FF44120	R/W
GPIO_PIN39_REG	Configuration for GPIO pin 39	0x3FF44124	R/W
GPIO_FUNC0_IN_SEL_CFG_REG	Peripheral function 0 input selection register	0x3FF44130	R/W
GPIO_FUNC1_IN_SEL_CFG_REG	Peripheral function 1 input selection register	0x3FF44134	R/W
...	...		
GPIO_FUNC254_IN_SEL_CFG_REG	Peripheral function 254 input selection register	0x3FF44528	R/W

Name	Description	Address	Access
GPIO_FUNC255_IN_SEL_CFG_REG	Peripheral function 255 input selection register	0x3FF4452C	R/W
GPIO_FUNC0_OUT_SEL_CFG_REG	Peripheral output selection for GPIO 0	0x3FF44530	R/W
GPIO_FUNC1_OUT_SEL_CFG_REG	Peripheral output selection for GPIO 1	0x3FF44534	R/W
...	...		
GPIO_FUNC38_OUT_SEL_CFG_REG	Peripheral output selection for GPIO 38	0x3FF445C8	R/W
GPIO_FUNC39_OUT_SEL_CFG_REG	Peripheral output selection for GPIO 39	0x3FF445CC	R/W

#### 4.12.2 IO\_MUX Register Summary

Name	Description	Address	Access
IO_MUX_PIN_CTRL	Clock output configuration register	0x3FF49000	R/W
IO_MUX_GPIO36_REG	Configuration register for pad GPIO36	0x3FF49004	R/W
IO_MUX_GPIO37_REG	Configuration register for pad GPIO37	0x3FF49008	R/W
IO_MUX_GPIO38_REG	Configuration register for pad GPIO38	0x3FF4900C	R/W
IO_MUX_GPIO39_REG	Configuration register for pad GPIO39	0x3FF49010	R/W
IO_MUX_GPIO34_REG	Configuration register for pad GPIO34	0x3FF49014	R/W
IO_MUX_GPIO35_REG	Configuration register for pad GPIO35	0x3FF49018	R/W
IO_MUX_GPIO32_REG	Configuration register for pad GPIO32	0x3FF4901C	R/W
IO_MUX_GPIO33_REG	Configuration register for pad GPIO33	0x3FF49020	R/W
IO_MUX_GPIO25_REG	Configuration register for pad GPIO25	0x3FF49024	R/W
IO_MUX_GPIO26_REG	Configuration register for pad GPIO26	0x3FF49028	R/W
IO_MUX_GPIO27_REG	Configuration register for pad GPIO27	0x3FF4902C	R/W
IO_MUX_MTMS_REG	Configuration register for pad MTMS	0x3FF49030	R/W
IO_MUX_MTDI_REG	Configuration register for pad MTDI	0x3FF49034	R/W
IO_MUX_MTCK_REG	Configuration register for pad MTCK	0x3FF49038	R/W
IO_MUX_MTDO_REG	Configuration register for pad MTDO	0x3FF4903C	R/W
IO_MUX_GPIO2_REG	Configuration register for pad GPIO2	0x3FF49040	R/W
IO_MUX_GPIO0_REG	Configuration register for pad GPIO0	0x3FF49044	R/W
IO_MUX_GPIO4_REG	Configuration register for pad GPIO4	0x3FF49048	R/W
IO_MUX_GPIO16_REG	Configuration register for pad GPIO16	0x3FF4904C	R/W
IO_MUX_GPIO17_REG	Configuration register for pad GPIO17	0x3FF49050	R/W
IO_MUX_SD_DATA2_REG	Configuration register for pad SD_DATA2	0x3FF49054	R/W
IO_MUX_SD_DATA3_REG	Configuration register for pad SD_DATA3	0x3FF49058	R/W
IO_MUX_SD_CMD_REG	Configuration register for pad SD_CMD	0x3FF4905C	R/W
IO_MUX_SD_CLK_REG	Configuration register for pad SD_CLK	0x3FF49060	R/W
IO_MUX_SD_DATA0_REG	Configuration register for pad SD_DATA0	0x3FF49064	R/W
IO_MUX_SD_DATA1_REG	Configuration register for pad SD_DATA1	0x3FF49068	R/W
IO_MUX_GPIO5_REG	Configuration register for pad GPIO5	0x3FF4906C	R/W
IO_MUX_GPIO18_REG	Configuration register for pad GPIO18	0x3FF49070	R/W
IO_MUX_GPIO19_REG	Configuration register for pad GPIO19	0x3FF49074	R/W
IO_MUX_GPIO20_REG	Configuration register for pad GPIO20	0x3FF49078	R/W
IO_MUX_GPIO21_REG	Configuration register for pad GPIO21	0x3FF4907C	R/W
IO_MUX_GPIO22_REG	Configuration register for pad GPIO22	0x3FF49080	R/W
IO_MUX_U0RXD_REG	Configuration register for pad U0RXD	0x3FF49084	R/W

Name	Description	Address	Access
IO_MUX_U0TXD_REG	Configuration register for pad U0TXD	0x3FF49088	R/W
IO_MUX_GPIO23_REG	Configuration register for pad GPIO23	0x3FF4908C	R/W
IO_MUX_GPIO24_REG	Configuration register for pad GPIO24	0x3FF49090	R/W

### 4.12.3 RTC IO MUX Register Summary

Name	Description	Address	Access
<b>GPIO configuration / data registers</b>			
RTCIO_RTC_GPIO_OUT_REG	RTC GPIO output register	0x3FF48400	R/W
RTCIO_RTC_GPIO_OUT_W1TS_REG	RTC GPIO output bit set register	0x3FF48404	WO
RTCIO_RTC_GPIO_OUT_W1TC_REG	RTC GPIO output bit clear register	0x3FF48408	WO
RTCIO_RTC_GPIO_ENABLE_REG	RTC GPIO output enable register	0x3FF4840C	R/W
RTCIO_RTC_GPIO_ENABLE_W1TS_REG	RTC GPIO output enable bit set register	0x3FF48410	WO
RTCIO_RTC_GPIO_ENABLE_W1TC_REG	RTC GPIO output enable bit clear register	0x3FF48414	WO
RTCIO_RTC_GPIO_STATUS_REG	RTC GPIO interrupt status register	0x3FF48418	WO
RTCIO_RTC_GPIO_STATUS_W1TS_REG	RTC GPIO interrupt status bit set register	0x3FF4841C	WO
RTCIO_RTC_GPIO_STATUS_W1TC_REG	RTC GPIO interrupt status bit clear register	0x3FF48420	WO
RTCIO_RTC_GPIO_IN_REG	RTC GPIO input register	0x3FF48424	RO
RTCIO_RTC_GPIO_PIN0_REG	RTC configuration for pin 0	0x3FF48428	R/W
RTCIO_RTC_GPIO_PIN1_REG	RTC configuration for pin 1	0x3FF4842C	R/W
RTCIO_RTC_GPIO_PIN2_REG	RTC configuration for pin 2	0x3FF48430	R/W
RTCIO_RTC_GPIO_PIN3_REG	RTC configuration for pin 3	0x3FF48434	R/W
RTCIO_RTC_GPIO_PIN4_REG	RTC configuration for pin 4	0x3FF48438	R/W
RTCIO_RTC_GPIO_PIN5_REG	RTC configuration for pin 5	0x3FF4843C	R/W
RTCIO_RTC_GPIO_PIN6_REG	RTC configuration for pin 6	0x3FF48440	R/W
RTCIO_RTC_GPIO_PIN7_REG	RTC configuration for pin 7	0x3FF48444	R/W
RTCIO_RTC_GPIO_PIN8_REG	RTC configuration for pin 8	0x3FF48448	R/W
RTCIO_RTC_GPIO_PIN9_REG	RTC configuration for pin 9	0x3FF4844C	R/W
RTCIO_RTC_GPIO_PIN10_REG	RTC configuration for pin 10	0x3FF48450	R/W
RTCIO_RTC_GPIO_PIN11_REG	RTC configuration for pin 11	0x3FF48454	R/W
RTCIO_RTC_GPIO_PIN12_REG	RTC configuration for pin 12	0x3FF48458	R/W
RTCIO_RTC_GPIO_PIN13_REG	RTC configuration for pin 13	0x3FF4845C	R/W
RTCIO_RTC_GPIO_PIN14_REG	RTC configuration for pin 14	0x3FF48460	R/W
RTCIO_RTC_GPIO_PIN15_REG	RTC configuration for pin 15	0x3FF48464	R/W
RTCIO_RTC_GPIO_PIN16_REG	RTC configuration for pin 16	0x3FF48468	R/W
RTCIO_RTC_GPIO_PIN17_REG	RTC configuration for pin 17	0x3FF4846C	R/W
RTCIO_DIG_PAD_HOLD_REG	RTC GPIO hold register	0x3FF48474	R/W
<b>GPIO RTC function configuration registers</b>			
RTCIO_HALL_SENS_REG	Hall sensor configuration	0x3FF48478	R/W
RTCIO_SENSOR_PADS_REG	Sensor pads configuration register	0x3FF4847C	R/W
RTCIO_ADC_PAD_REG	ADC configuration register	0x3FF48480	R/W
RTCIO_PAD_DAC1_REG	DAC1 configuration register	0x3FF48484	R/W
RTCIO_PAD_DAC2_REG	DAC2 configuration register	0x3FF48488	R/W
RTCIO_XTAL_32K_PAD_REG	32KHz crystal pads configuration register	0x3FF4848C	R/W

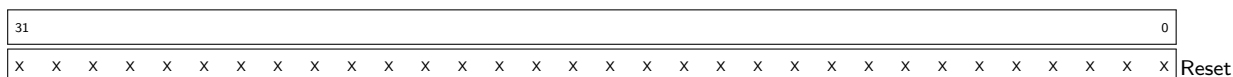
Name	Description	Address	Access
<a href="#">RTCIO_TOUCH_CFG_REG</a>	Touch sensor configuration register	0x3FF48490	R/W
<a href="#">RTCIO_TOUCH_PAD0_REG</a>	Touch pad configuration register	0x3FF48494	R/W
...	...		
<a href="#">RTCIO_TOUCH_PAD9_REG</a>	Touch pad configuration register	0x3FF484B8	R/W
<a href="#">RTCIO_EXT_WAKEUP0_REG</a>	External wake up configuration register	0x3FF484BC	R/W
<a href="#">RTCIO_XTL_EXT_CTR_REG</a>	Crystal power down enable GPIO source	0x3FF484C0	R/W
<a href="#">RTCIO_SAR_I2C_IO_REG</a>	RTC I2C pad selection	0x3FF484C4	R/W

## 4.13 Registers

### 4.13.1 GPIO Matrix Registers

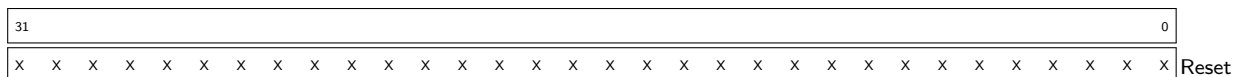
The addresses in parenthesis besides register names are the register addresses relative to the GPIO base address provided in Table 1-6 *Peripheral Address Mapping* in Chapter 1 *System and Memory*. The absolute register addresses are listed in Section 4.12.1 *GPIO Matrix Register Summary*.

**Register 4.1. GPIO\_OUT\_REG (0x0004)**



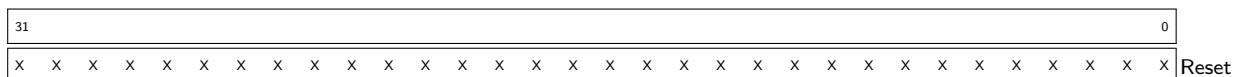
**GPIO\_OUT\_REG** GPIO0-31 output value. (R/W)

**Register 4.2. GPIO\_OUT\_W1TS\_REG (0x0008)**



**GPIO\_OUT\_W1TS\_REG** GPIO0-31 output set register. For every bit that is 1 in the value written here, the corresponding bit in GPIO\_OUT\_REG will be set. (WO)

**Register 4.3. GPIO\_OUT\_W1TC\_REG (0x000c)**



**GPIO\_OUT\_W1TC\_REG** GPIO0-31 output clear register. For every bit that is 1 in the value written here, the corresponding bit in GPIO\_OUT\_REG will be cleared. (WO)

**Register 4.4. GPIO\_OUT1\_REG (0x0010)**

(reserved)																GPIO_OUT_DATA									
31																8	7								0
0 0																x x x x x x x x x								Reset	

**GPIO\_OUT\_DATA** GPIO32-39 output value. (R/W)

**Register 4.5. GPIO\_OUT1\_W1TS\_REG (0x0014)**

(reserved)																GPIO_OUT_DATA									
31																8	7								0
0 0																x x x x x x x x x								Reset	

**GPIO\_OUT\_DATA** GPIO32-39 output value set register. For every bit that is 1 in the value written here, the corresponding bit in GPIO\_OUT1\_DATA will be set. (WO)

**Register 4.6. GPIO\_OUT1\_W1TC\_REG (0x0018)**

(reserved)																GPIO_OUT_DATA									
31																8	7								0
0 0																x x x x x x x x x								Reset	

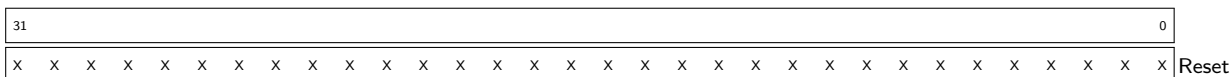
**GPIO\_OUT\_DATA** GPIO32-39 output value clear register. For every bit that is 1 in the value written here, the corresponding bit in GPIO\_OUT1\_DATA will be cleared. (WO)

**Register 4.7. GPIO\_ENABLE\_REG (0x0020)**

31																															0	
x x																																Reset

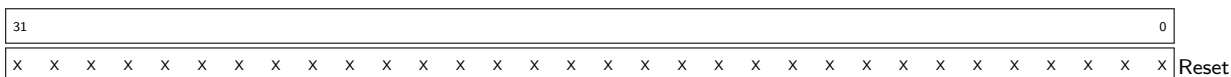
**GPIO\_ENABLE\_REG** GPIO0-31 output enable. (R/W)

**Register 4.8. GPIO\_ENABLE\_W1TS\_REG (0x0024)**



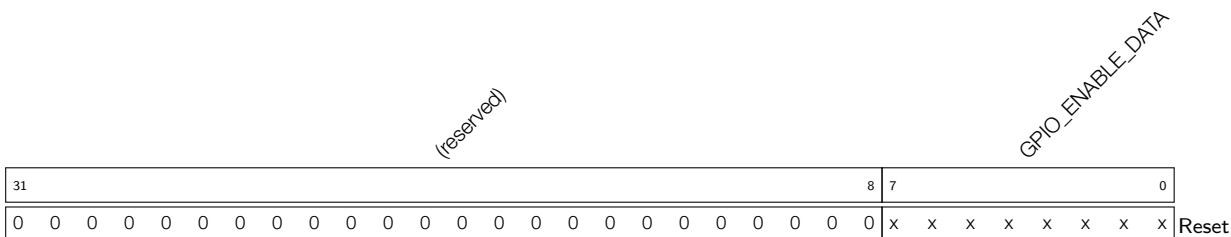
**GPIO\_ENABLE\_W1TS\_REG** GPIO0-31 output enable set register. For every bit that is 1 in the value written here, the corresponding bit in GPIO\_ENABLE will be set. (WO)

**Register 4.9. GPIO\_ENABLE\_W1TC\_REG (0x0028)**



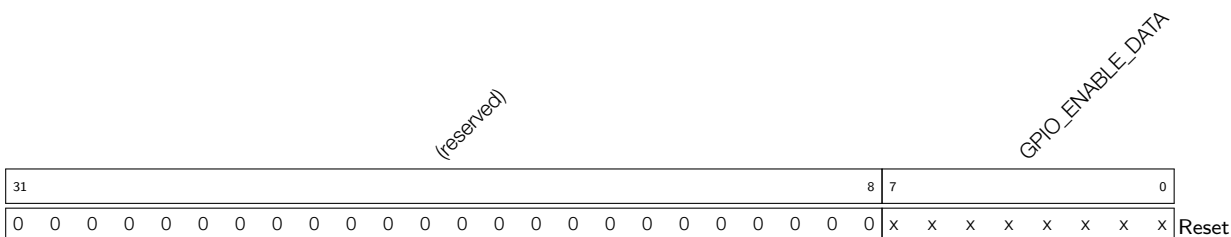
**GPIO\_ENABLE\_W1TC\_REG** GPIO0-31 output enable clear register. For every bit that is 1 in the value written here, the corresponding bit in GPIO\_ENABLE will be cleared. (WO)

**Register 4.10. GPIO\_ENABLE1\_REG (0x002c)**



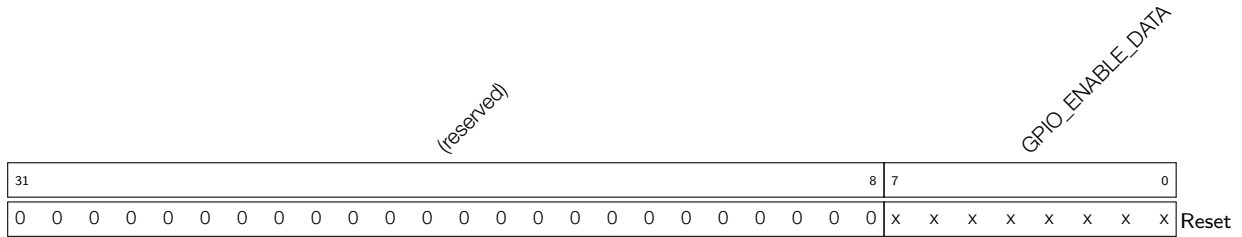
**GPIO\_ENABLE\_DATA** GPIO32-39 output enable. (R/W)

**Register 4.11. GPIO\_ENABLE1\_W1TS\_REG (0x0030)**

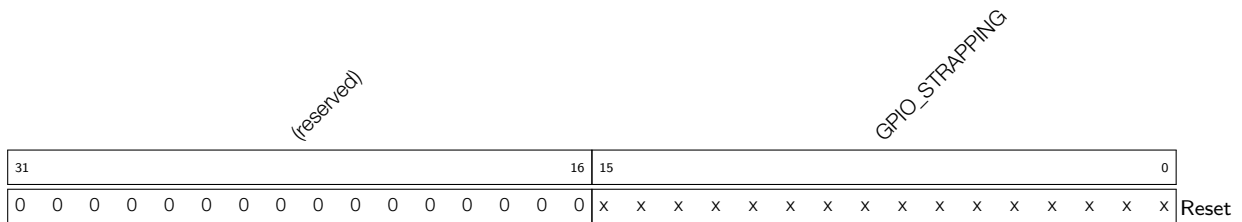


**GPIO\_ENABLE\_DATA** GPIO32-39 output enable set register. For every bit that is 1 in the value written here, the corresponding bit in GPIO\_ENABLE1 will be set. (WO)

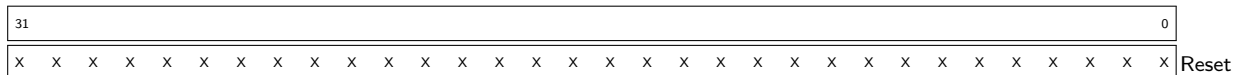


**Register 4.12. GPIO\_ENABLE1\_W1TC\_REG (0x0034)**

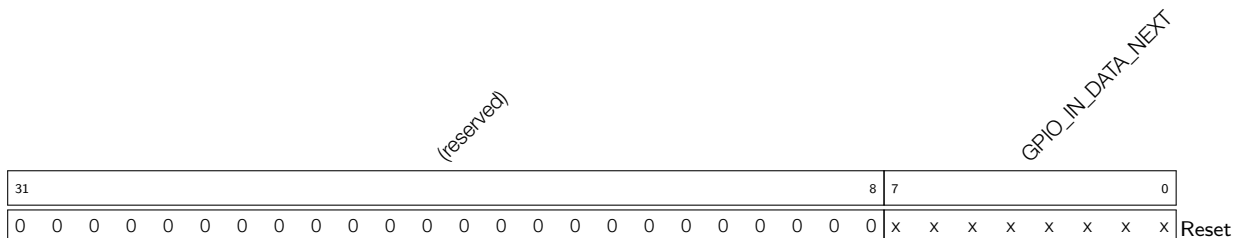
**GPIO\_ENABLE\_DATA** GPIO32-39 output enable clear register. For every bit that is 1 in the value written here, the corresponding bit in GPIO\_ENABLE1 will be cleared. (WO)

**Register 4.13. GPIO\_STRAP\_REG (0x0038)**

**GPIO\_STRAPPING** GPIO strapping results: Bit5-bit0 of boot\_sel\_chip[5:0] correspond to MTDI, GPIO0, GPIO2, GPIO4, MTDO, GPIO5, respectively.

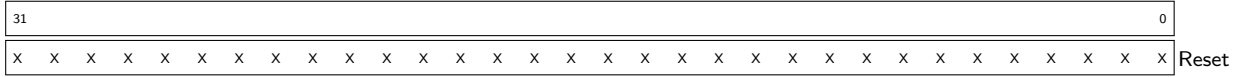
**Register 4.14. GPIO\_IN\_REG (0x003c)**

**GPIO\_IN\_REG** GPIO0-31 input value. Each bit represents a pad input value, 1 for high level and 0 for low level. (RO)

**Register 4.15. GPIO\_IN1\_REG (0x0040)**

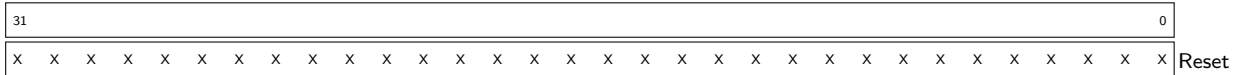
**GPIO\_IN\_DATA\_NEXT** GPIO32-39 input value. Each bit represents a pad input value. (RO)

**Register 4.16. GPIO\_STATUS\_REG (0x0044)**



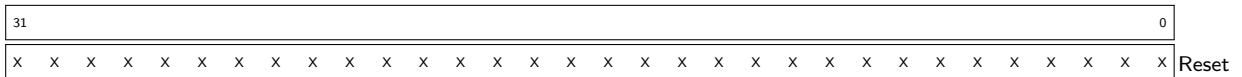
**GPIO\_STATUS\_REG** GPIO0-31 interrupt status register. Each bit can be either of the two interrupt sources for the two CPUs. The enable bits in GPIO\_STATUS\_INTERRUPT, corresponding to the 0-4 bits in GPIO\_PIN<sub>n</sub>\_REG should be set to 1. (R/W)

**Register 4.17. GPIO\_STATUS\_W1TS\_REG (0x0048)**



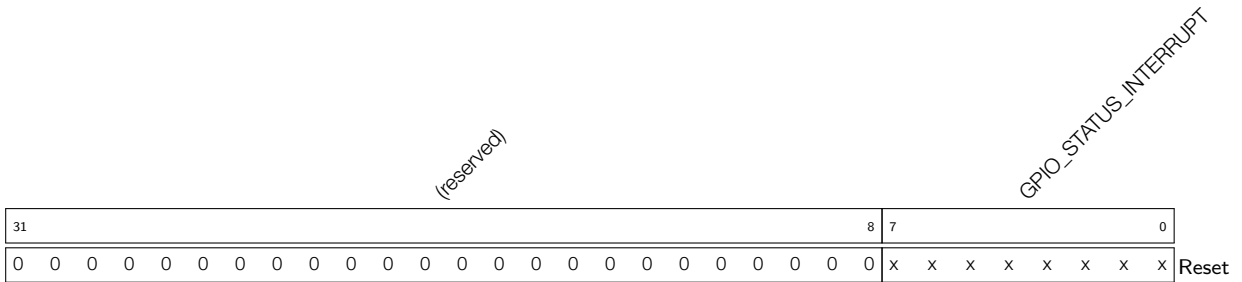
**GPIO\_STATUS\_W1TS\_REG** GPIO0-31 interrupt status set register. For every bit that is 1 in the value written here, the corresponding bit in GPIO\_STATUS\_INTERRUPT will be set. (WO)

**Register 4.18. GPIO\_STATUS\_W1TC\_REG (0x004c)**



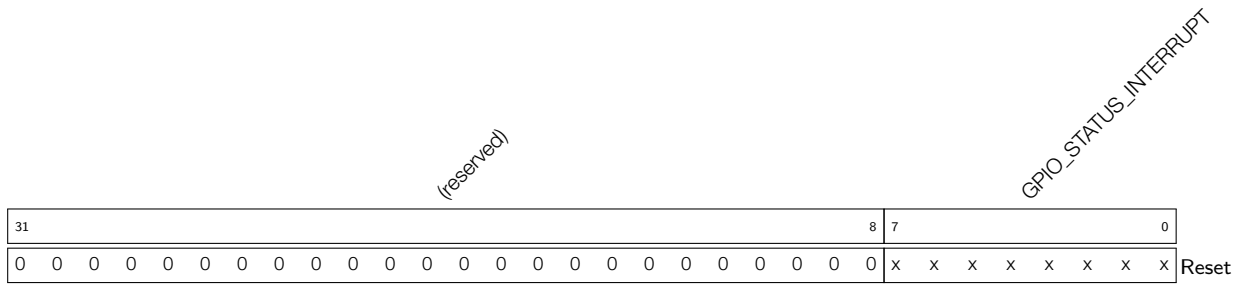
**GPIO\_STATUS\_W1TC\_REG** GPIO0-31 interrupt status clear register. For every bit that is 1 in the value written here, the corresponding bit in GPIO\_STATUS\_INTERRUPT will be cleared. (WO)

**Register 4.19. GPIO\_STATUS1\_REG (0x0050)**



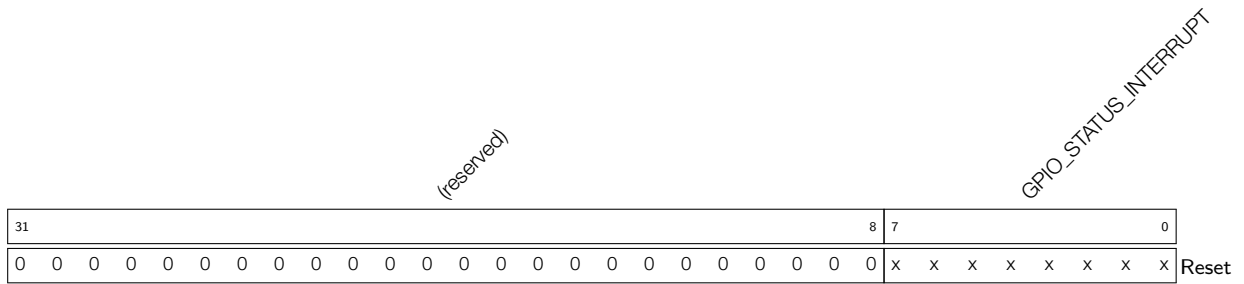
**GPIO\_STATUS\_INTERRUPT** GPIO32-39 interrupt status. (R/W)

**Register 4.20. GPIO\_STATUS1\_W1TS\_REG (0x0054)**



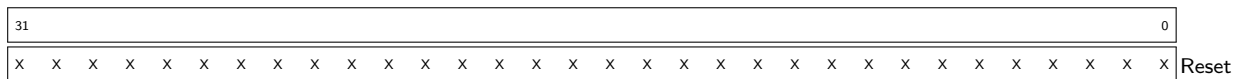
**GPIO\_STATUS\_INTERRUPT** GPIO32-39 interrupt status set register. For every bit that is 1 in the value written here, the corresponding bit in GPIO\_STATUS\_INTERRUPT1 will be set. (WO)

**Register 4.21. GPIO\_STATUS1\_W1TC\_REG (0x0058)**



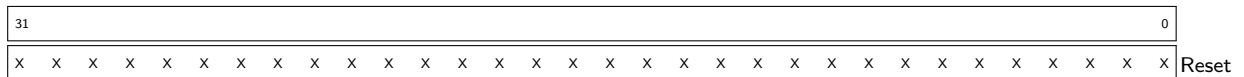
**GPIO\_STATUS\_INTERRUPT** GPIO32-39 interrupt status clear register. For every bit that is 1 in the value written here, the corresponding bit in GPIO\_STATUS\_INTERRUPT1 will be cleared. (WO)

**Register 4.22. GPIO\_ACPU\_INT\_REG (0x0060)**



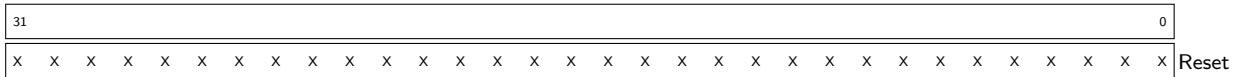
**GPIO\_ACPU\_INT\_REG** GPIO00-31 APP CPU interrupt status. (RO)

**Register 4.23. GPIO\_ACPU\_NMI\_INT\_REG (0x0064)**



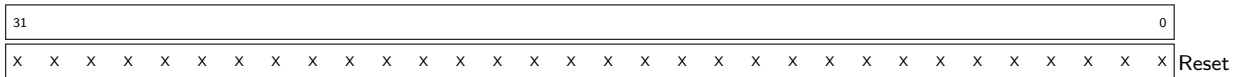
**GPIO\_ACPU\_NMI\_INT\_REG** GPIO00-31 APP CPU non-maskable interrupt status. (RO)

**Register 4.24. GPIO\_PCPU\_INT\_REG (0x0068)**



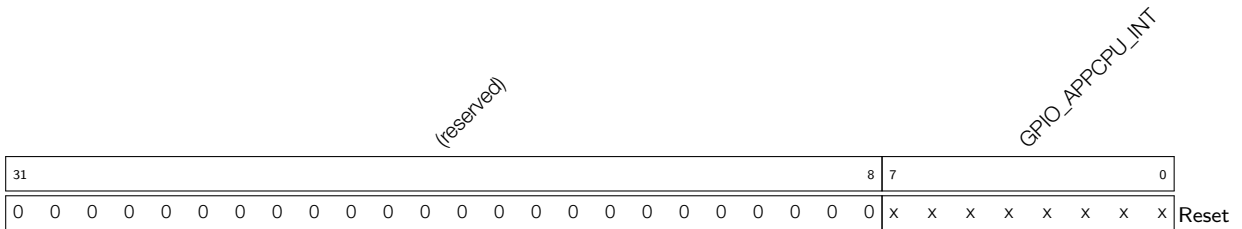
**GPIO\_PCPU\_INT\_REG** GPIO0-31 PRO CPU interrupt status. (RO)

**Register 4.25. GPIO\_PCPU\_NMI\_INT\_REG (0x006c)**



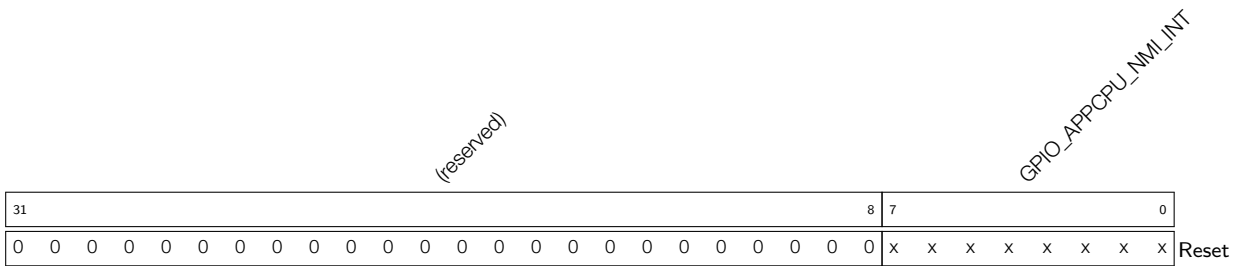
**GPIO\_PCPU\_NMI\_INT\_REG** GPIO0-31 PRO CPU non-maskable interrupt status. (RO)

**Register 4.26. GPIO\_ACPU\_INT1\_REG (0x0074)**



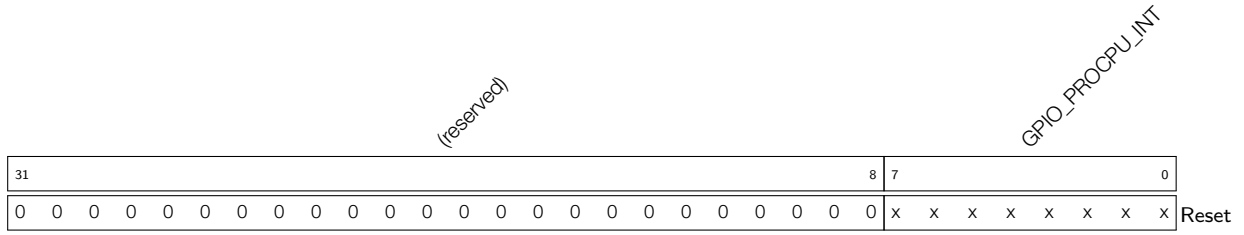
**GPIO\_APPCPU\_INT** GPIO32-39 APP CPU interrupt status. (RO)

**Register 4.27. GPIO\_ACPU\_NMI\_INT1\_REG (0x0078)**



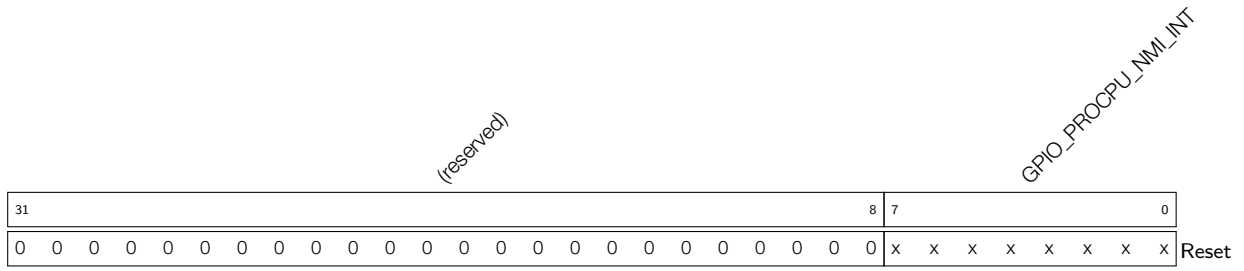
**GPIO\_APPCPU\_NMI\_INT** GPIO32-39 APP CPU non-maskable interrupt status. (RO)

**Register 4.28. GPIO\_PCPU\_INT1\_REG (0x007c)**



**GPIO\_PROCPU\_INT** GPIO32-39 PRO CPU interrupt status. (RO)

**Register 4.29. GPIO\_PCPU\_NMI\_INT1\_REG (0x0080)**



**GPIO\_PROCPU\_NMI\_INT** GPIO32-39 PRO CPU non-maskable interrupt status. (RO)

**Register 4.30. GPIO\_PIN $n$ \_REG ( $n$ : 0-39) (0x88+0x4\* $n$ )**

(reserved)																	GPIO_PIN $n$ _INT_ENA				(reserved)				GPIO_PIN $n$ _WAKEUP_ENABLE				GPIO_PIN $n$ _INT_TYPE				(reserved)				GPIO_PIN $n$ _PAD_DRIVER				(reserved)			
31																		18	17					13	12	11	10	9			7	6				3	2	1	0					
0	0	0	0	0	0	0	0	0	0	0	0	0	0	0	0	0	0	x	x	x	x	x	0	0	x	x	x	x	0	0	0	0	x	0	0									

Reset

**GPIO\_PIN $n$ \_INT\_ENA** Interrupt enable bits for pin  $n$ : (R/W)

- bit0: APP CPU interrupt enable;
- bit1: APP CPU non-maskable interrupt enable;
- bit2: PRO CPU interrupt enable;
- bit3: PRO CPU non-maskable interrupt enable.

**GPIO\_PIN $n$ \_WAKEUP\_ENABLE** GPIO wake-up enable will only wake up the CPU from Light-sleep. (R/W)

**GPIO\_PIN $n$ \_INT\_TYPE** Interrupt type selection: (R/W)

- 0: GPIO interrupt disable;
- 1: rising edge trigger;
- 2: falling edge trigger;
- 3: any edge trigger;
- 4: low level trigger;
- 5: high level trigger.

**GPIO\_PIN $n$ \_PAD\_DRIVER** 0: normal output; 1: open drain output. (R/W)

**Register 4.31. GPIO\_FUNC $y$ \_IN\_SEL\_CFG\_REG ( $y$ : 0-255) (0x130+0x4\* $y$ )**

(reserved)																								GPIO_SIG $y$ _IN_SEL				GPIO_FUNC $y$ _IN_INV_SEL				GPIO_FUNC $y$ _IN_SEL													
31																								8	7	6	5																		0
0	0	0	0	0	0	0	0	0	0	0	0	0	0	0	0	0	0	0	0	0	0	0	0	0	0	0	0	0	0	0	0	0	0	0	x	x	x	x	x	x	x	x	x		

Reset

**GPIO\_SIG $y$ \_IN\_SEL** Bypass the GPIO Matrix. 1: route through GPIO Matrix, 0: connect signal directly to peripheral configured in the IO\_MUX. (R/W)

**GPIO\_FUNC $y$ \_IN\_INV\_SEL** Invert the input value. 1: invert; 0: do not invert. (R/W)

**GPIO\_FUNC $y$ \_IN\_SEL** Selection control for peripheral input  $y$ . A value of 0-39 selects which of the 40 GPIO Matrix input pins this signal is connected to, or 0x38 for a constantly high input or 0x30 for a constantly low input. (R/W)

Register 4.32. GPIO\_FUNC $n$ \_OUT\_SEL\_CFG\_REG ( $n$ : 0-19, 21-23, 25-27, 32-33) (0x530+0x4\* $n$ )

(reserved)												GPIO_FUNC $n$ _OEN_INV_SEL			GPIO_FUNC $n$ _OEN_SEL			GPIO_FUNC $n$ _OUT_INV_SEL			GPIO_FUNC $n$ _OUT_SEL		
31												12	11	10	9	8							0
0	0	0	0	0	0	0	0	0	0	0	0	x	x	x	x	x	x	x	x	x	x	x	Reset

**GPIO\_FUNC $n$ \_OEN\_INV\_SEL** 1: Invert the output enable signal; 0: do not invert the output enable signal. (R/W)

**GPIO\_FUNC $n$ \_OEN\_SEL** 1: Force the output enable signal to be sourced from bit  $n$  of GPIO\_ENABLE\_REG; 0: use output enable signal from peripheral. (R/W)

**GPIO\_FUNC $n$ \_OUT\_INV\_SEL** 1: Invert the output value; 0: do not invert the output value. (R/W)

**GPIO\_FUNC $n$ \_OUT\_SEL** Selection control for GPIO output  $n$ . A value of  $s$  ( $0 \leq s < 256$ ) connects peripheral output  $s$  to GPIO output  $n$ . A value of 256 selects bit  $n$  of GPIO\_OUT\_REG/GPIO\_OUT1\_REG and GPIO\_ENABLE\_REG/GPIO\_ENABLE1\_REG as the output value and output enable. (R/W)

### 4.13.2 IO MUX Registers

The addresses in parenthesis besides register names are the register addresses relative to the IO MUX base addresses provided in Table 1-6 *Peripheral Address Mapping* in Chapter 1 *System and Memory*. The absolute register addresses are listed in Section 4.12.2 *IO MUX Register Summary*.

**Register 4.33. IO\_MUX\_PIN\_CTRL (0x00)**

(reserved)												PIN_CTRL_CLK3			PIN_CTRL_CLK2			PIN_CTRL_CLK1						
31												12	11			8	7			4	3			0
0x0												0x0			0x0			0x0			Reset			

**If you want to output clock for I2S0 (I2S0\_CLK) to:**

CLK\_OUT1, then set PIN\_CTRL[3:0] = 0x0;

CLK\_OUT2, then set PIN\_CTRL[3:0] = 0x0 and PIN\_CTRL[7:4] = 0x0;

CLK\_OUT3, then set PIN\_CTRL[3:0] = 0x0 and PIN\_CTRL[11:8] = 0x0.

**If you want to output clock for I2S1 (I2S1\_CLK) to:**

CLK\_OUT1, then set PIN\_CTRL[3:0] = 0xF;

CLK\_OUT2, then set PIN\_CTRL[3:0] = 0xF and PIN\_CTRL[7:4] = 0x0;

CLK\_OUT3, then set PIN\_CTRL[3:0] = 0xF and PIN\_CTRL[11:8] = 0x0.

**If you want to output clock for APLL to**

CLK\_OUT1, then set PIN\_CTRL[3:0] = 0x6;

CLK\_OUT2, then set PIN\_CTRL[3:0] = 0x6 and PIN\_CTRL[7:4] = 0x6;

CLK\_OUT3, then set PIN\_CTRL[3:0] = 0x6 and PIN\_CTRL[11:8] = 0x6. (R/W)

**Note:**

- Only the above mentioned combinations of clock source (i.e. I2S0/1\_CLK, APLL clock) and clock output pins (i.e. CLK\_OUT1 ~ 3) are possible.
- The CLK\_OUT1 ~ 3 can be found in the [IO\\_MUX Pad Summary](#).



**Register 4.34. IO\_MUX\_x\_REG (x: GPIO0-GPIO39) (0x10+4\*x)**

(reserved)																MCU_SEL	FUN_DRV	FUN_IE	FUN_WPU	FUN_WPD	MCU_DRV	MCU_IE	MCU_WPU	MCU_WPD	SLP_SEL	MCU_OE								
31	30	29	28	27	26	25	24	23	22	21	20	19	18	17	16	15	14	13	12	11	10	9	8	7	6	5	4	3	2	1	0			
0	0	0	0	0	0	0	0	0	0	0	0	0	0	0	0	0	0	0	0	0	0	0	0	0	0	0	0	0	0	0	0	0	0	Reset

**MCU\_SEL** Select the IO\_MUX function for this signal. 0 selects Function 0, 1 selects Function 1, etc. (R/W)

**FUN\_DRV** Select the drive strength of the pad. A higher value corresponds with a higher strength. For GPIO34-39, FUN\_DRV is always 0. For detailed drive strength, please see note 8 in Table "Notes on ESP32 Pin Lists", in [ESP32 Datasheet](#). (R/W)

**FUN\_IE** Input enable of the pad. 1: input enabled; 0: input disabled. (R/W)

**FUN\_WPU** Pull-up enable of the pad. 1: internal pull-up enabled; 0: internal pull-up disabled. GPIO pins 34-39 are input-only. These pins do not feature an output driver or internal pull-up/pull-down circuitry, therefore, their FUN\_WPU is always 0. (R/W)

**FUN\_WPD** Pull-down enable of the pad. 1: internal pull-down enabled, 0: internal pull-down disabled. GPIO pins 34-39 are input-only. These pins do not feature an output driver or internal pull-up/pull-down circuitry, therefore, their FUN\_WPD is always 0. (R/W)

**MCU\_DRV** Select the drive strength of the pad during sleep mode. A higher value corresponds with a higher strength. (R/W)

**MCU\_IE** Input enable of the pad during sleep mode. 1: input enabled; 0: input disabled. (R/W)

**MCU\_WPU** Pull-up enable of the pad during sleep mode. 1: internal pull-up enabled; 0: internal pull-up disabled. (R/W)

**MCU\_WPD** Pull-down enable of the pad during sleep mode. 1: internal pull-down enabled; 0: internal pull-down disabled. (R/W)

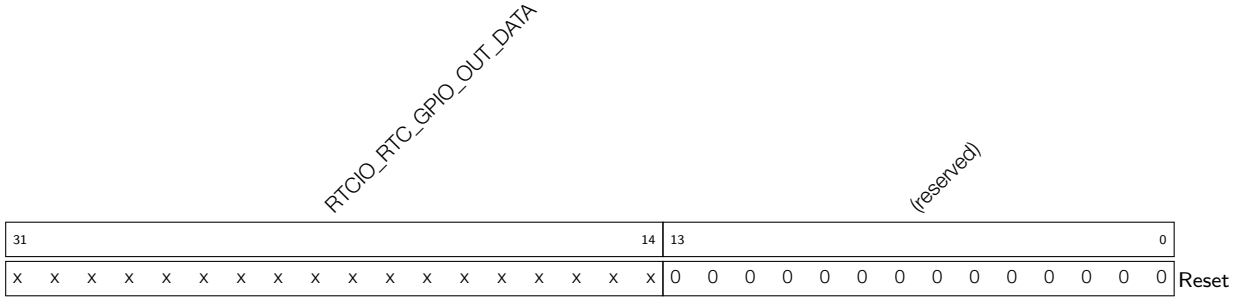
**SLP\_SEL** Sleep mode selection of this pad. Set to 1 to put the pad in sleep mode. (R/W)

**MCU\_OE** Output enable of the pad in sleep mode. 1: enable output; 0: disable output. (R/W)

### 4.13.3 RTC IO MUX Registers

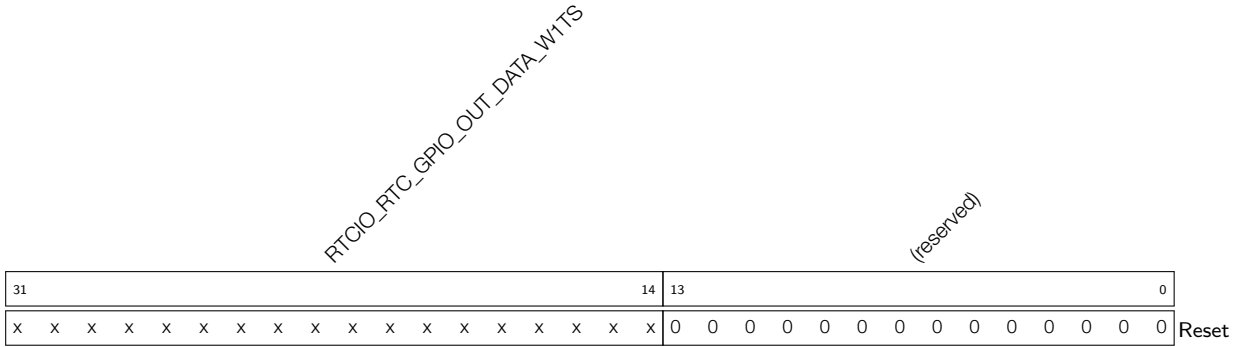
The addresses in parenthesis besides register names are the register addresses relative to (the RTC base address + 0x0400). The RTC base address is provided in Table 1-6 *Peripheral Address Mapping* in Chapter 1 *System and Memory*. The absolute register addresses are listed in Section 4.12.3 *RTC IO MUX Register Summary*.

**Register 4.35. RTCIO\_RTC\_GPIO\_OUT\_REG (0x0000)**



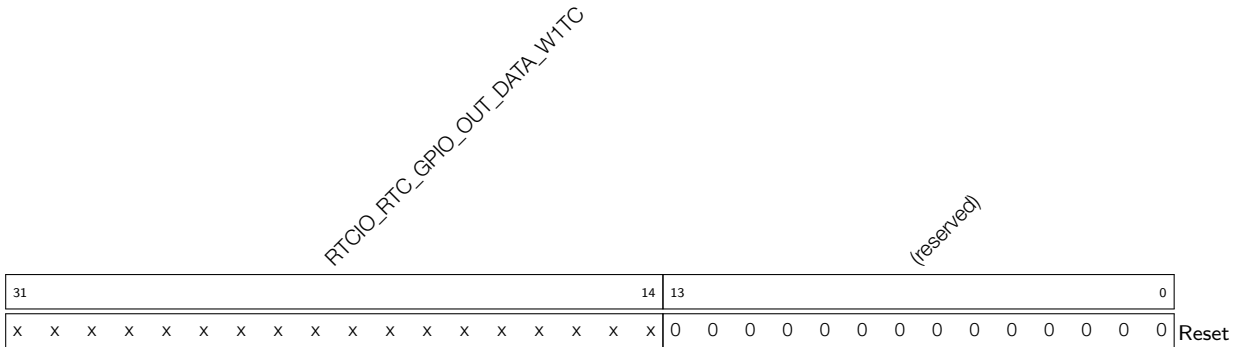
**RTCIO\_RTC\_GPIO\_OUT\_DATA** GPIO0-17 output register. Bit14 is GPIO[0], bit15 is GPIO[1], etc. (R/W)

**Register 4.36. RTCIO\_RTC\_GPIO\_OUT\_W1TS\_REG (0x0004)**



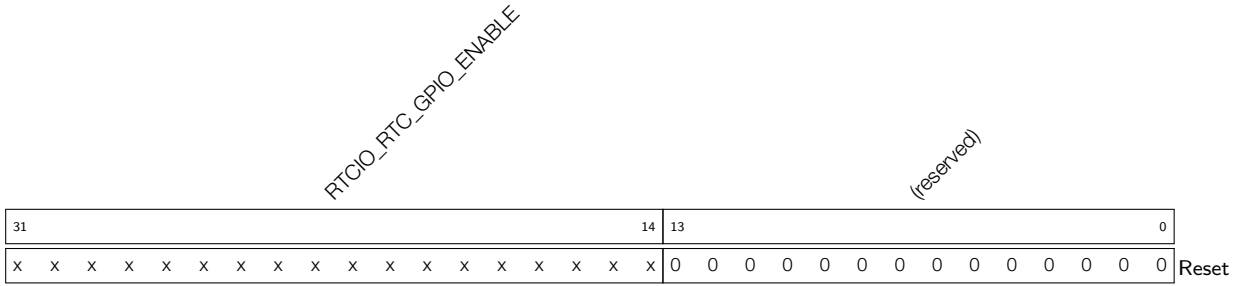
**RTCIO\_RTC\_GPIO\_OUT\_DATA\_W1TS** GPIO0-17 output set register. For every bit that is 1 in the value written here, the corresponding bit in RTCIO\_RTC\_GPIO\_OUT will be set. (WO)

**Register 4.37. RTCIO\_RTC\_GPIO\_OUT\_W1TC\_REG (0x0008)**



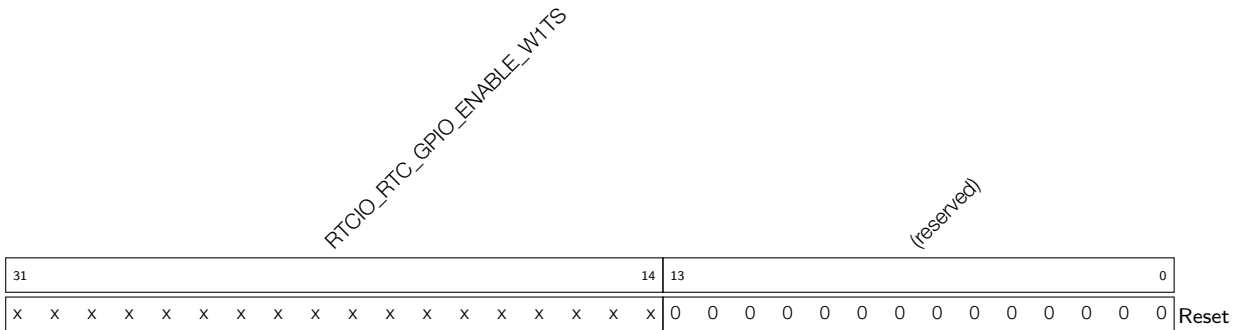
**RTCIO\_RTC\_GPIO\_OUT\_DATA\_W1TC** GPIO0-17 output clear register. For every bit that is 1 in the value written here, the corresponding bit in RTCIO\_RTC\_GPIO\_OUT will be cleared. (WO)

**Register 4.38. RTCIO\_RTC\_GPIO\_ENABLE\_REG (0x000C)**



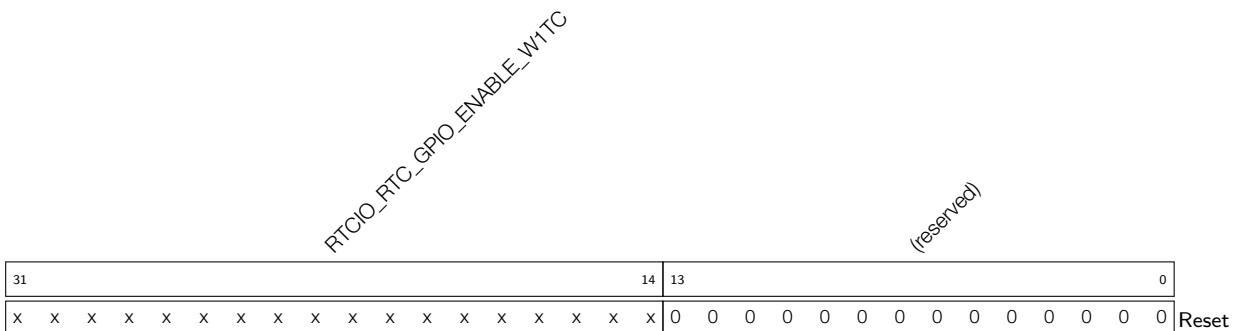
**RTCIO\_RTC\_GPIO\_ENABLE** GPIO0-17 output enable. Bit14 is GPIO[0], bit15 is GPIO[1], etc. 1 means this GPIO pad is output. (R/W)

**Register 4.39. RTCIO\_RTC\_GPIO\_ENABLE\_W1TS\_REG (0x0010)**



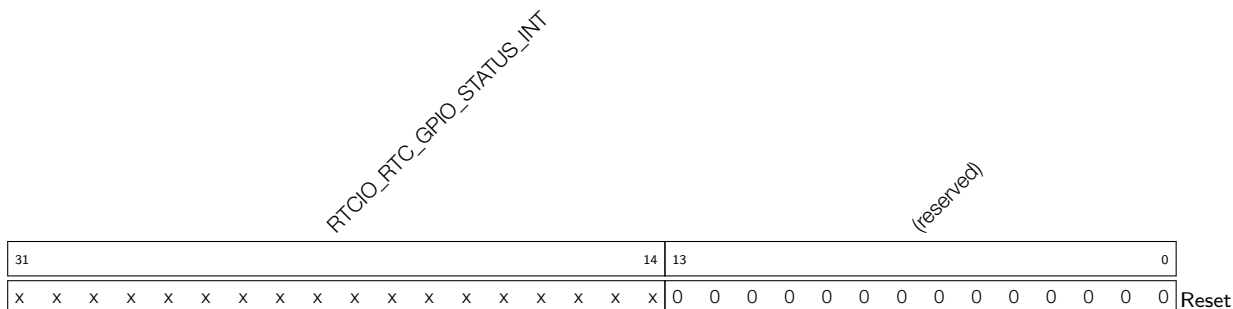
**RTCIO\_RTC\_GPIO\_ENABLE\_W1TS** GPIO0-17 output enable set register. For every bit that is 1 in the value written here, the corresponding bit in RTCIO\_RTC\_GPIO\_ENABLE will be set. (WO)

**Register 4.40. RTCIO\_RTC\_GPIO\_ENABLE\_W1TC\_REG (0x0014)**



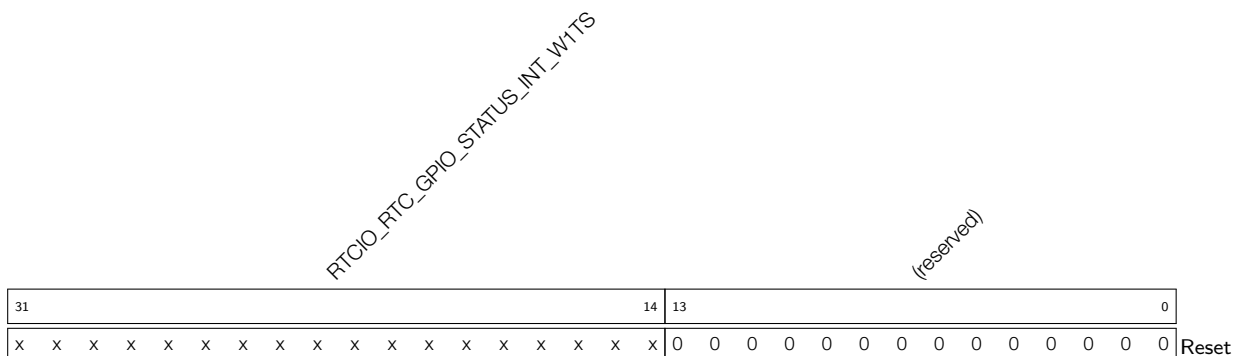
**RTCIO\_RTC\_GPIO\_ENABLE\_W1TC** GPIO0-17 output enable clear register. For every bit that is 1 in the value written here, the corresponding bit in RTCIO\_RTC\_GPIO\_ENABLE will be cleared. (WO)

**Register 4.41. RTCIO\_RTC\_GPIO\_STATUS\_REG (0x0018)**



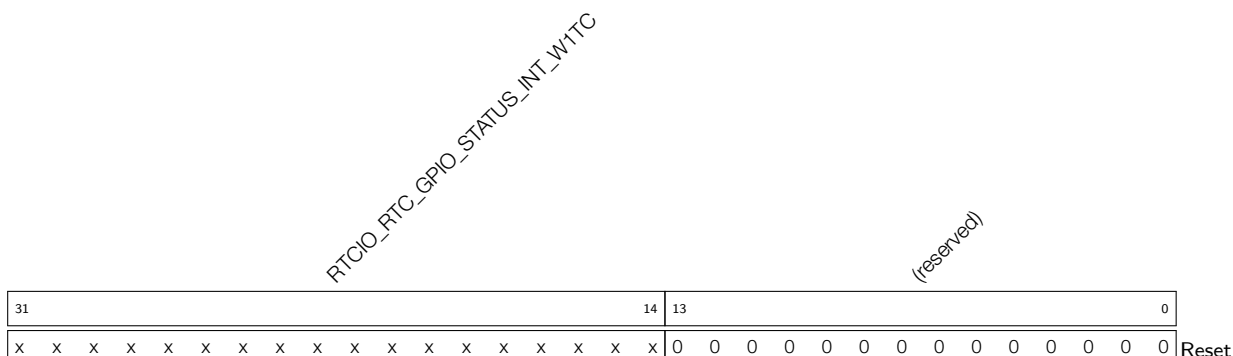
**RTCIO\_RTC\_GPIO\_STATUS\_INT** GPIO0-17 interrupt status. Bit14 is GPIO[0], bit15 is GPIO[1], etc. This register should be used together with RTCIO\_RTC\_GPIO\_PIN<sub>n</sub>\_INT\_TYPE in RTCIO\_RTC\_GPIO\_PIN<sub>n</sub>\_REG. 1: corresponding interrupt; 0: no interrupt. (R/W)

**Register 4.42. RTCIO\_RTC\_GPIO\_STATUS\_W1TS\_REG (0x001C)**



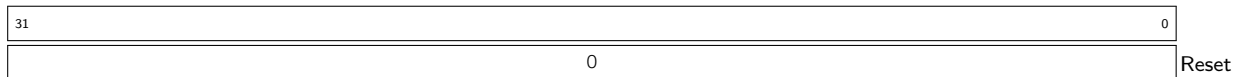
**RTCIO\_RTC\_GPIO\_STATUS\_INT\_W1TS** GPIO0-17 interrupt set register. For every bit that is 1 in the value written here, the corresponding bit in RTCIO\_RTC\_GPIO\_STATUS\_INT will be set. (WO)

**Register 4.43. RTCIO\_RTC\_GPIO\_STATUS\_W1TC\_REG (0x0020)**



**RTCIO\_RTC\_GPIO\_STATUS\_INT\_W1TC** GPIO0-17 interrupt clear register. For every bit that is 1 in the value written here, the corresponding bit in RTCIO\_RTC\_GPIO\_STATUS\_INT will be cleared. (WO)



**Register 4.46. RTCIO\_DIG\_PAD\_HOLD\_REG (0x0074)**

**RTCIO\_DIG\_PAD\_HOLD\_REG** Selects the digital pads which should be put on hold. While 0 allows normal operation, 1 puts the pad on hold. (R/W)

Name	Description
Bit[0]	Set to 1 to enable the Hold function of pad U0RTD
Bit[1]	Set to 1 to enable the Hold function of pad U0TXD
Bit[2]	Set to 1 to enable the Hold function of pad SD_CLK
Bit[3]	Set to 1 to enable the Hold function of pad SD_DATA0
Bit[4]	Set to 1 to enable the Hold function of pad SD_DATA1
Bit[5]	Set to 1 to enable the Hold function of pad SD_DATA2
Bit[6]	Set to 1 to enable the Hold function of pad SD_DATA3
Bit[7]	Set to 1 to enable the Hold function of pad SD_CMD
Bit[8]	Set to 1 to enable the Hold function of pad GPIO5
Bit[9]	Set to 1 to enable the Hold function of pad GPIO16
Bit[10]	Set to 1 to enable the Hold function of pad GPIO17
Bit[11]	Set to 1 to enable the Hold function of pad GPIO18
Bit[12]	Set to 1 to enable the Hold function of pad GPIO19
Bit[13]	Set to 1 to enable the Hold function of pad GPIO20
Bit[14]	Set to 1 to enable the Hold function of pad GPIO21
Bit[15]	Set to 1 to enable the Hold function of pad GPIO22
Bit[16]	Set to 1 to enable the Hold function of pad GPIO23



**Register 4.49. RTCIO\_ADC\_PAD\_REG (0x0080)**

(reserved)																		
31	30	29	28	27	26	25	24	23	22	21	20	19	18	17			0	
0	0	0	0	0	0	0	0	0	0	0	0	0	0	0	0	0	0	0

Reset

**RTCIO\_ADC\_ADC $n$ \_HOLD** Set to 1 to hold the output value on the pad; 0 is for normal operation. (R/W)

**RTCIO\_ADC\_ADC $n$ \_MUX\_SEL** 0: route pad to the digital IO\_MUX; (R/W)  
1: route pad to the RTC block.

**RTCIO\_ADC\_ADC $n$ \_FUN\_SEL** Select the RTC function for this pad. 0: select Function 0; 3: select Function 1. (R/W)

**RTCIO\_ADC\_ADC $n$ \_SLP\_SEL** Signal selection of pad's sleep mode. Set this bit to 1 to put the pad to sleep. (R/W)

**RTCIO\_ADC\_ADC $n$ \_SLP\_IE** Input enable of the pad in sleep mode. 1 enabled; 0 disabled. (R/W)

**RTCIO\_ADC\_ADC $n$ \_FUN\_IE** Input enable of the pad. 1 enabled; 0 disabled. (R/W)



**Register 4.50. RTCIO\_PAD\_DAC1\_REG (0x0084)**

<i>RTCIO_PAD_PDAC1_DRV</i>		<i>RTCIO_PAD_PDAC1_HOLD</i>		<i>RTCIO_PAD_PDAC1_RDE</i>		<i>RTCIO_PAD_PDAC1_RUE</i>		<i>RTCIO_PAD_PDAC1_DAC</i>		<i>RTCIO_PAD_PDAC1_XPD_DAC</i>		<i>RTCIO_PAD_PDAC1_MUX_SEL</i>		<i>RTCIO_PAD_PDAC1_FUN_SEL</i>		<i>RTCIO_PAD_PDAC1_SLP_SEL</i>		<i>RTCIO_PAD_PDAC1_SLP_IE</i>		<i>RTCIO_PAD_PDAC1_SLP_OE</i>		<i>RTCIO_PAD_PDAC1_FUN_IE</i>		<i>RTCIO_PAD_PDAC1_DAC_XPD_FORCE</i>		<i>(reserved)</i>				
31	30	29	28	27	26					19	18	17	16	15	14	13	12	11	10	9									0	
2	0	0	0			0				0	0	0	0	0	0	0	0	0	0	0	0	0	0	0	0	0	0	0	0	Reset

**RTCIO\_PAD\_PDAC1\_DRV** Select the drive strength of the pad. (R/W)

**RTCIO\_PAD\_PDAC1\_HOLD** Set to 1 to hold the output value on the pad; set to 0 for normal operation. (R/W)

**RTCIO\_PAD\_PDAC1\_RDE** 1: Pull-down on pad enabled; 0: Pull-down disabled. (R/W)

**RTCIO\_PAD\_PDAC1\_RUE** 1: Pull-up on pad enabled; 0: Pull-up disabled. (R/W)

**RTCIO\_PAD\_PDAC1\_DAC** PAD DAC1 output value. (R/W)

**RTCIO\_PAD\_PDAC1\_XPD\_DAC** Power on DAC1. Usually, PDAC1 needs to be tristated if we power on the DAC, i.e. IE=0, OE=0, RDE=0, RUE=0. (R/W)

**RTCIO\_PAD\_PDAC1\_MUX\_SEL** 0: route pad to the digital IO\_MUX; (R/W)  
1: route to the RTC block.

**RTCIO\_PAD\_PDAC1\_FUN\_SEL** the functional selection signal of the pad. (R/W)

**RTCIO\_PAD\_PDAC1\_SLP\_SEL** Sleep mode selection signal of the pad. Set this bit to 1 to put the pad to sleep. (R/W)

**RTCIO\_PAD\_PDAC1\_SLP\_IE** Input enable of the pad in sleep mode. 1: enabled; 0: disabled. (R/W)

**RTCIO\_PAD\_PDAC1\_SLP\_OE** Output enable of the pad. 1: enabled ; 0: disabled. (R/W)

**RTCIO\_PAD\_PDAC1\_FUN\_IE** Input enable of the pad. 1: enabled it; 0: disabled. (R/W)

**RTCIO\_PAD\_PDAC1\_DAC\_XPD\_FORCE** Power on DAC1. Usually, we need to tristate PDAC1 if we power on the DAC, i.e. IE=0, OE=0, RDE=0, RUE=0. (R/W)

**Register 4.51. RTCIO\_PAD\_DAC2\_REG (0x0088)**

RTCIO_PAD_PDAC2_DRV		RTCIO_PAD_PDAC2_HOLD		RTCIO_PAD_PDAC2_RDE		RTCIO_PAD_PDAC2_RUE		RTCIO_PAD_PDAC2_DAC		RTCIO_PAD_PDAC2_XPD_DAC		RTCIO_PAD_PDAC2_MUX_SEL		RTCIO_PAD_PDAC2_FUN_SEL		RTCIO_PAD_PDAC2_SLP_SEL		RTCIO_PAD_PDAC2_SLP_IE		RTCIO_PAD_PDAC2_SLP_OE		RTCIO_PAD_PDAC2_FUN_IE		RTCIO_PAD_PDAC2_DAC_XPD_FORCE		(reserved)			
31	30	29	28	27	26					19	18	17	16	15	14	13	12	11	10	9								0	
2	0	0	0			0				0	0	0	0	0	0	0	0	0	0	0	0	0	0	0	0	0	0	0	Reset

**RTCIO\_PAD\_PDAC2\_DRV** Select the drive strength of the pad. (R/W)

**RTCIO\_PAD\_PDAC2\_HOLD** Set to 1 to hold the output value on the pad; 0 is for normal operation. (R/W)

**RTCIO\_PAD\_PDAC2\_RDE** 1: Pull-down on pad enabled; 0: Pull-down disabled. (R/W)

**RTCIO\_PAD\_PDAC2\_RUE** 1: Pull-up on pad enabled; 0: Pull-up disabled. (R/W)

**RTCIO\_PAD\_PDAC2\_DAC** PAD DAC2 output value. (R/W)

**RTCIO\_PAD\_PDAC2\_XPD\_DAC** Power on DAC2. PDAC2 needs to be tristated if we power on the DAC, i.e. IE=0, OE=0, RDE=0, RUE=0. (R/W)

**RTCIO\_PAD\_PDAC2\_MUX\_SEL** 0: route pad to the digital IO\_MUX; (R/W)  
1: route to the RTC block.

**RTCIO\_PAD\_PDAC2\_FUN\_SEL** Select the RTC function for this pad. 0: select Function 0. (R/W)

**RTCIO\_PAD\_PDAC2\_SLP\_SEL** Sleep mode selection signal of the pad. Set this bit to 1 to put the pad to sleep. (R/W)

**RTCIO\_PAD\_PDAC2\_SLP\_IE** Input enable of the pad in sleep mode. 1: enabled; 0: disabled. (R/W)

**RTCIO\_PAD\_PDAC2\_SLP\_OE** Output enable of the pad. 1: enabled; 0: disabled. (R/W)

**RTCIO\_PAD\_PDAC2\_FUN\_IE** Input enable of the pad. 1: enabled; 0: disabled. (R/W)

**RTCIO\_PAD\_PDAC2\_DAC\_XPD\_FORCE** Power on DAC2. Usually, we need to tristate PDAC2 if we power on the DAC, i.e. IE=0, OE=0, RDE=0, RUE=0. (R/W)

## Register 4.52. RTCIO\_XTAL\_32K\_PAD\_REG (0x008C)

31	30	29	28	27	26	25	24	23	22	21	20	19	18	17	16	15	14	13	12	11	10	9	8	7	6	5	4	3	2	1	0	
2	0	0	0	0	2	0	0	0	0	0	1	0	0	0	0	0	0	0	0	0	0	0	0	0	0	0	0	1	0	0	0	0

Reset

**RTCIO\_XTAL\_X32N\_DRV** Select the drive strength of the pad. (R/W)

**RTCIO\_XTAL\_X32N\_HOLD** Set to 1 to hold the output value on the pad; 0 is for normal operation. (R/W)

**RTCIO\_XTAL\_X32N\_RDE** 1: Pull-down on pad enabled; 0: Pull-down disabled. (R/W)

**RTCIO\_XTAL\_X32N\_RUE** 1: Pull-up on pad enabled; 0: Pull-up disabled. (R/W)

**RTCIO\_XTAL\_X32P\_DRV** Select the drive strength of the pad. (R/W)

**RTCIO\_XTAL\_X32P\_HOLD** Set to 1 to hold the output value on the pad, 0 is for normal operation. (R/W)

**RTCIO\_XTAL\_X32P\_RDE** 1: Pull-down on pad enabled; 0: Pull-down disabled. (R/W)

**RTCIO\_XTAL\_X32P\_RUE** 1: Pull-up on pad enabled; 0: Pull-up disabled. (R/W)

**RTCIO\_XTAL\_DAC\_XTAL\_32K** 32K XTAL bias current DAC value. (R/W)

**RTCIO\_XTAL\_XPD\_XTAL\_32K** Power up 32 KHz crystal oscillator. (R/W)

**RTCIO\_XTAL\_X32N\_MUX\_SEL** 0: route X32N pad to the digital IO\_MUX; 1: route to RTC block. (R/W)

**RTCIO\_XTAL\_X32P\_MUX\_SEL** 0: route X32P pad to the digital IO\_MUX; 1: route to RTC block. (R/W)

**RTCIO\_XTAL\_X32N\_FUN\_SEL** Select the RTC function. 0: select function 0. (R/W)

**RTCIO\_XTAL\_X32N\_SLP\_SEL** Sleep mode selection. Set this bit to 1 to put the pad to sleep. (R/W)

**RTCIO\_XTAL\_X32N\_SLP\_IE** Input enable of the pad in sleep mode. 1: enabled; 0: disabled. (R/W)

**RTCIO\_XTAL\_X32N\_SLP\_OE** Output enable of the pad. 1: enabled; 0: disabled. (R/W)

**RTCIO\_XTAL\_X32N\_FUN\_IE** Input enable of the pad. 1: enabled; 0: disabled. (R/W)

**RTCIO\_XTAL\_X32P\_FUN\_SEL** Select the RTC function. 0: select function 0; 1: select function 1. (R/W)

**RTCIO\_XTAL\_X32P\_SLP\_SEL** Sleep mode selection. Set this bit to 1 to put the pad to sleep. (R/W)

**RTCIO\_XTAL\_X32P\_SLP\_IE** Input enable of the pad in sleep mode. 1: enabled; 0: disabled. (R/W)

Continued on the next page...

**Register 4.52. RTCIO\_XTAL\_32K\_PAD\_REG (0x008C)**

Continued from the previous page...

**RTCIO\_XTAL\_X32P\_SLP\_OE** Output enable of the pad in sleep mode. 1: enabled; 0: disabled.  
(R/W)

**RTCIO\_XTAL\_X32P\_FUN\_IE** Input enable of the pad. 1: enabled; 0: disabled. (R/W)

**RTCIO\_XTAL\_DRES\_XTAL\_32K** 32K XTAL resistor bias control. (R/W)

**RTCIO\_XTAL\_DBIAS\_XTAL\_32K** 32K XTAL self-bias reference control. (R/W)

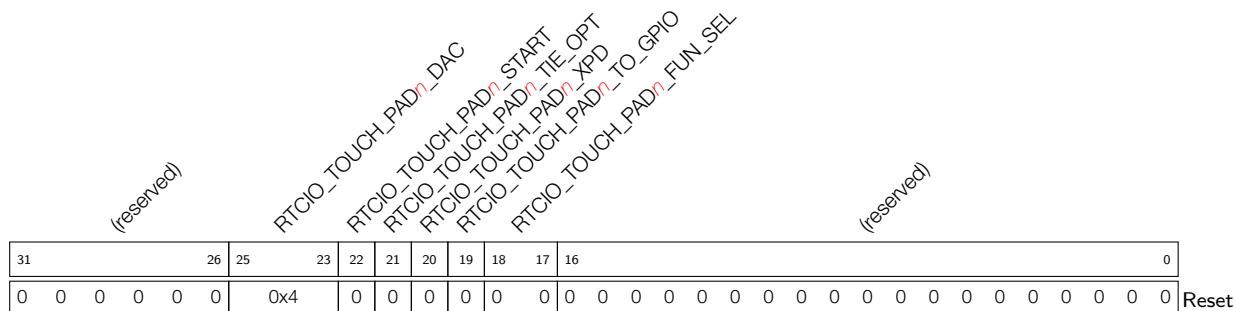
**Register 4.53. RTCIO\_TOUCH\_CFG\_REG (0x0090)**

	<i>(reserved)</i>																										
RTCIO_TOUCH_XPD_BIAS																					0						
RTCIO_TOUCH_DREFH																					0						
RTCIO_TOUCH_DREFL																					0						
RTCIO_TOUCH_DRANGE																					0						
RTCIO_TOUCH_DCUR																					0						
31	30	29	28	27	26	25	24	23	22											0							
0	1	1	0	0	1	1	0	0	0	0	0	0	0	0	0	0	0	0	0	0	0	0	0	0	0	0	0

Reset

- RTCIO\_TOUCH\_XPD\_BIAS** Touch sensor bias power on bit. 1: power on; 0: disabled. (R/W)
- RTCIO\_TOUCH\_DREFH** Touch sensor saw wave top voltage. (R/W)
- RTCIO\_TOUCH\_DREFL** Touch sensor saw wave bottom voltage. (R/W)
- RTCIO\_TOUCH\_DRANGE** Touch sensor saw wave voltage range. (R/W)
- RTCIO\_TOUCH\_DCUR** Touch sensor bias current. When BIAS\_SLEEP is enabled, this setting is available. (R/W)

**Register 4.54. RTCIO\_TOUCH\_PAD $n$ \_REG ( $n$ : 0-9) (94+4\* $n$ )**



**RTCIO\_TOUCH\_PAD $n$ \_DAC** Touch sensor slope control. 3-bit for each touch pad, defaults to 100. (R/W)

**RTCIO\_TOUCH\_PAD $n$ \_START** Start touch sensor. (R/W)

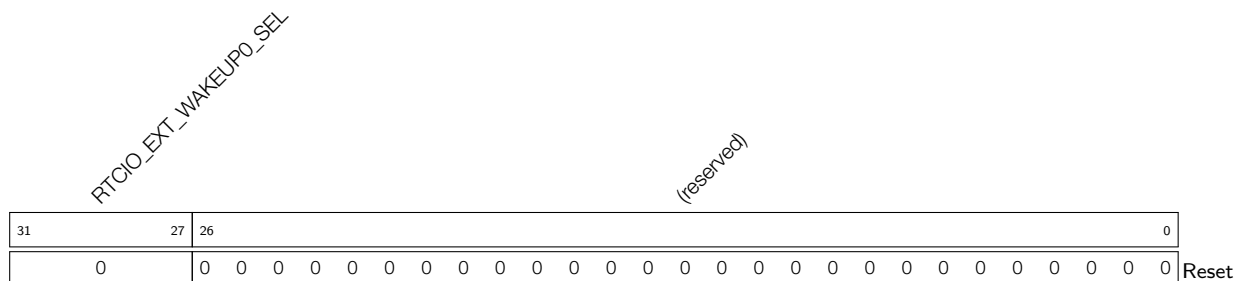
**RTCIO\_TOUCH\_PAD $n$ \_TIE\_OPT** Default touch sensor tie option. 0: tie low; 1: tie high. (R/W)

**RTCIO\_TOUCH\_PAD $n$ \_XPD** Touch sensor power on. (R/W)

**RTCIO\_TOUCH\_PAD $n$ \_TO\_GPIO** Connect the RTC pad input to digital pad input; 0 is available. (R/W)

**RTCIO\_TOUCH\_PAD $n$ \_FUN\_SEL** Selects the function of RTC pad. 0: RTC Function 0. (R/W)

**Register 4.55. RTCIO\_EXT\_WAKEUP0\_REG (0x00BC)**



**RTCIO\_EXT\_WAKEUP0\_SEL** GPIO[0-17] can be used to wake up the chip when the chip is in the sleep mode. This register prompts the pad source to wake up the chip when the latter is in deep/light sleep mode. 0: select GPIO0; 1: select GPIO2, etc. (R/W)



## 5 DPort Registers

### 5.1 Introduction

The ESP32 integrates a large number of peripherals, and enables the control of individual peripherals to achieve optimal characteristics in performance-vs-power-consumption scenarios. The DPort registers control clock management (clock gating), power management, and the configuration of peripherals and core-system modules. The system arranges each module with configuration registers contained in the DPort Register.

### 5.2 Features

DPort registers correspond to different peripheral blocks and core modules:

- System and memory
- Reset and clock
- Interrupt matrix
- DMA
- MPU/MMU
- APP\_CPU controller
- Peripheral clock gating and reset

### 5.3 Functional Description

#### 5.3.1 System and Memory Register

System and memory registers are used for system and memory configuration, such as cache configuration and memory remapping. They are listed in Section 5.4, categorized as "System and memory registers". For a detailed description of these registers, please refer to Chapter [System and Memory](#).

#### 5.3.2 Reset and Clock Registers

Reset and clock registers are listed in Section 5.4, categorized as "Reset and clock registers". For a detailed description of these registers, please refer to Chapter [Reset and Clock](#).

#### 5.3.3 Interrupt Matrix Register

The interrupt matrix registers are used for configuring and mapping interrupts through the interrupt matrix. They are listed in Section 5.4, categorized as "Interrupt matrix registers". For a detailed description of these registers, please refer to Chapter [Interrupt Matrix \(INTERRUPT\)](#).

#### 5.3.4 DMA Registers

DMA registers are used for the SPI DMA configuration. They are listed in Section 5.4, categorized as "DMA registers". For a detailed description of these registers, please refer to Chapter [DMA Controller \(DMA\)](#).

#### 5.3.5 MPU/MMU Registers

MPU/MMU registers are used for MPU/MMU configuration and operation control. They are listed in Section 5.4, categorized as "MPU/MMU registers". For a detailed description of these registers, please refer to Chapter [Memory Management and Protection Units \(MMU, MPU\)](#).

### 5.3.6 APP\_CPU Controller Registers

APP\_CPU controller registers are used for some basic configuration of the APP\_CPU, such as performing a stalling execution, and for configuring the ROM boot jump address. The registers are listed in Section 5.4, categorized as "APP\_CPU controller registers". A detailed description of these registers is provided in section 5.5. Note that reset bits are not self-clearing.

### 5.3.7 Peripheral Clock Gating and Reset

Peripheral clock gating and reset registers are listed in Section 5.4. They are active-high registers. A detailed description of these registers is provided in section 5.5. Note that reset bits are not self-clearing.



## 5.4 Register Summary

Name	Description	Address	Access
<b>System and memory registers</b>			
DPORT_PRO_BOOT_REMAP_CTRL_REG	remap mode for PRO_CPU	0x3FF00000	R/W
DPORT_APP_BOOT_REMAP_CTRL_REG	remap mode for APP_CPU	0x3FF00004	R/W
DPORT_CACHE_MUX_MODE_REG	the mode of the two caches sharing the memory	0x3FF0007C	R/W
<b>Reset and clock registers</b>			
DPORT_CPU_PER_CONF_REG	Selects CPU clock	0x3FF0003C	R/W
<b>Interrupt matrix registers</b>			
DPORT_CPU_INTR_FROM_CPU_0_REG	interrupt 0 in both CPUs	0x3FF000DC	R/W
DPORT_CPU_INTR_FROM_CPU_1_REG	interrupt 1 in both CPUs	0x3FF000E0	R/W
DPORT_CPU_INTR_FROM_CPU_2_REG	interrupt 2 in both CPUs	0x3FF000E4	R/W
DPORT_CPU_INTR_FROM_CPU_3_REG	interrupt 3 in both CPUs	0x3FF000E8	R/W
DPORT_PRO_INTR_STATUS_REG_0_REG	PRO_CPU interrupt status 0	0x3FF000EC	RO
DPORT_PRO_INTR_STATUS_REG_1_REG	PRO_CPU interrupt status 1	0x3FF000F0	RO
DPORT_PRO_INTR_STATUS_REG_2_REG	PRO_CPU interrupt status 2	0x3FF000F4	RO
DPORT_APP_INTR_STATUS_REG_0_REG	APP_CPU interrupt status 0	0x3FF000F8	RO
DPORT_APP_INTR_STATUS_REG_1_REG	APP_CPU interrupt status 1	0x3FF000FC	RO
DPORT_APP_INTR_STATUS_REG_2_REG	APP_CPU interrupt status 2	0x3FF00100	RO
DPORT_PRO_MAC_INTR_MAP_REG	interrupt map	0x3FF00104	R/W
DPORT_PRO_MAC_NMI_MAP_REG	interrupt map	0x3FF00108	R/W
DPORT_PRO_BB_INT_MAP_REG	interrupt map	0x3FF0010C	R/W
DPORT_PRO_BT_MAC_INT_MAP_REG	interrupt map	0x3FF00110	R/W
DPORT_PRO_BT_BB_INT_MAP_REG	interrupt map	0x3FF00114	R/W
DPORT_PRO_BT_BB_NMI_MAP_REG	interrupt map	0x3FF00118	R/W
DPORT_PRO_RWBT_IRQ_MAP_REG	interrupt map	0x3FF0011C	R/W
DPORT_PRO_RWBLE_IRQ_MAP_REG	interrupt map	0x3FF00120	R/W
DPORT_PRO_RWBT_NMI_MAP_REG	interrupt map	0x3FF00124	R/W
DPORT_PRO_RWBLE_NMI_MAP_REG	interrupt map	0x3FF00128	R/W
DPORT_PRO_SLC0_INTR_MAP_REG	interrupt map	0x3FF0012C	R/W
DPORT_PRO_SLC1_INTR_MAP_REG	interrupt map	0x3FF00130	R/W
DPORT_PRO_UHCI0_INTR_MAP_REG	interrupt map	0x3FF00134	R/W
DPORT_PRO_UHCI1_INTR_MAP_REG	interrupt map	0x3FF00138	R/W
DPORT_PRO_TG_T0_LEVEL_INT_MAP_REG	interrupt map	0x3FF0013C	R/W
DPORT_PRO_TG_T1_LEVEL_INT_MAP_REG	interrupt map	0x3FF00140	R/W
DPORT_PRO_TG_WDT_LEVEL_INT_MAP_REG	interrupt map	0x3FF00144	R/W
DPORT_PRO_TG_LACT_LEVEL_INT_MAP_REG	interrupt map	0x3FF00148	R/W
DPORT_PRO_TG1_T0_LEVEL_INT_MAP_REG	interrupt map	0x3FF0014C	R/W
DPORT_PRO_TG1_T1_LEVEL_INT_MAP_REG	interrupt map	0x3FF00150	R/W
DPORT_PRO_TG1_WDT_LEVEL_INT_MAP_REG	interrupt map	0x3FF00154	R/W
DPORT_PRO_TG1_LACT_LEVEL_INT_MAP_REG	interrupt map	0x3FF00158	R/W
DPORT_PRO_GPIO_INTERRUPT_MAP_REG	interrupt map	0x3FF0015C	R/W
DPORT_PRO_GPIO_INTERRUPT_NMI_MAP_REG	interrupt map	0x3FF00160	R/W

Name	Description	Address	Access
DPORT_PRO_CPU_INTR_FROM_CPU_0_MAP_REG	interrupt map	0x3FF00164	R/W
DPORT_PRO_CPU_INTR_FROM_CPU_1_MAP_REG	interrupt map	0x3FF00168	R/W
DPORT_PRO_CPU_INTR_FROM_CPU_2_MAP_REG	Interrupt map	0x3FF0016C	R/W
DPORT_PRO_CPU_INTR_FROM_CPU_3_MAP_REG	interrupt map	0x3FF00170	R/W
DPORT_PRO_SPI_INTR_0_MAP_REG	interrupt map	0x3FF00174	R/W
DPORT_PRO_SPI_INTR_1_MAP_REG	interrupt map	0x3FF00178	R/W
DPORT_PRO_SPI_INTR_2_MAP_REG	interrupt map	0x3FF0017C	R/W
DPORT_PRO_SPI_INTR_3_MAP_REG	interrupt map	0x3FF00180	R/W
DPORT_PRO_I2S0_INT_MAP_REG	interrupt map	0x3FF00184	R/W
DPORT_PRO_I2S1_INT_MAP_REG	interrupt map	0x3FF00188	R/W
DPORT_PRO_UART_INTR_MAP_REG	interrupt map	0x3FF0018C	R/W
DPORT_PRO_UART1_INTR_MAP_REG	interrupt map	0x3FF00190	R/W
DPORT_PRO_UART2_INTR_MAP_REG	interrupt map	0x3FF00194	R/W
DPORT_PRO_SDIO_HOST_INTERRUPT_MAP_REG	interrupt map	0x3FF00198	R/W
DPORT_PRO_EMAC_INT_MAP_REG	interrupt map	0x3FF0019C	R/W
DPORT_PRO_PWM0_INTR_MAP_REG	interrupt map	0x3FF001A0	R/W
DPORT_PRO_PWM1_INTR_MAP_REG	interrupt map	0x3FF001A4	R/W
DPORT_PRO_LEDC_INT_MAP_REG	interrupt map	0x3FF001B0	R/W
DPORT_PRO_EFUSE_INT_MAP_REG	interrupt map	0x3FF001B4	R/W
DPORT_PRO_TWAI_INT_MAP_REG	interrupt map	0x3FF001B8	R/W
DPORT_PRO_RTC_CORE_INTR_MAP_REG	interrupt map	0x3FF001BC	R/W
DPORT_PRO_RMT_INTR_MAP_REG	interrupt map	0x3FF001C0	R/W
DPORT_PRO_PCNT_INTR_MAP_REG	interrupt map	0x3FF001C4	R/W
DPORT_PRO_I2C_EXT0_INTR_MAP_REG	interrupt map	0x3FF001C8	R/W
DPORT_PRO_I2C_EXT1_INTR_MAP_REG	interrupt map	0x3FF001CC	R/W
DPORT_PRO_RSA_INTR_MAP_REG	interrupt map	0x3FF001D0	R/W
DPORT_PRO_SPI1_DMA_INT_MAP_REG	interrupt map	0x3FF001D4	R/W
DPORT_PRO_SPI2_DMA_INT_MAP_REG	interrupt map	0x3FF001D8	R/W
DPORT_PRO_SPI3_DMA_INT_MAP_REG	interrupt map	0x3FF001DC	R/W
DPORT_PRO_WDG_INT_MAP_REG	interrupt map	0x3FF001E0	R/W
DPORT_PRO_TIMER_INT1_MAP_REG	interrupt map	0x3FF001E4	R/W
DPORT_PRO_TIMER_INT2_MAP_REG	interrupt map	0x3FF001E8	R/W
DPORT_PRO_TG_T0_EDGE_INT_MAP_REG	interrupt map	0x3FF001EC	R/W
DPORT_PRO_TG_T1_EDGE_INT_MAP_REG	interrupt map	0x3FF001F0	R/W
DPORT_PRO_TG_WDT_EDGE_INT_MAP_REG	interrupt map	0x3FF001F4	R/W
DPORT_PRO_TG_LACT_EDGE_INT_MAP_REG	interrupt map	0x3FF001F8	R/W
DPORT_PRO_TG1_T0_EDGE_INT_MAP_REG	interrupt map	0x3FF001FC	R/W
DPORT_PRO_TG1_T1_EDGE_INT_MAP_REG	interrupt map	0x3FF00200	R/W
DPORT_PRO_TG1_WDT_EDGE_INT_MAP_REG	interrupt map	0x3FF00204	R/W
DPORT_PRO_TG1_LACT_EDGE_INT_MAP_REG	interrupt map	0x3FF00208	R/W
DPORT_PRO_MMU_IA_INT_MAP_REG	interrupt map	0x3FF0020C	R/W
DPORT_PRO_MPU_IA_INT_MAP_REG	interrupt map	0x3FF00210	R/W
DPORT_PRO_CACHE_IA_INT_MAP_REG	interrupt map	0x3FF00214	R/W

Name	Description	Address	Access
DPORT_APP_MAC_INTR_MAP_REG	interrupt map	0x3FF00218	R/W
DPORT_APP_MAC_NMI_MAP_REG	interrupt map	0x3FF0021C	R/W
DPORT_APP_BB_INT_MAP_REG	interrupt map	0x3FF00220	R/W
DPORT_APP_BT_MAC_INT_MAP_REG	interrupt map	0x3FF00224	R/W
DPORT_APP_BT_BB_INT_MAP_REG	interrupt map	0x3FF00228	R/W
DPORT_APP_BT_BB_NMI_MAP_REG	interrupt map	0x3FF0022C	R/W
DPORT_APP_RWBTT_IRQ_MAP_REG	interrupt map	0x3FF00230	R/W
DPORT_APP_RWBLE_IRQ_MAP_REG	interrupt map	0x3FF00234	R/W
DPORT_APP_RWBTT_NMI_MAP_REG	interrupt map	0x3FF00238	R/W
DPORT_APP_RWBLE_NMI_MAP_REG	interrupt map	0x3FF0023C	R/W
DPORT_APP_SLC0_INTR_MAP_REG	interrupt map	0x3FF00240	R/W
DPORT_APP_SLC1_INTR_MAP_REG	interrupt map	0x3FF00244	R/W
DPORT_APP_UHCI0_INTR_MAP_REG	interrupt map	0x3FF00248	R/W
DPORT_APP_UHCI1_INTR_MAP_REG	interrupt map	0x3FF0024C	R/W
DPORT_APP_TG_T0_LEVEL_INT_MAP_REG	interrupt map	0x3FF00250	R/W
DPORT_APP_TG_T1_LEVEL_INT_MAP_REG	interrupt map	0x3FF00254	R/W
DPORT_APP_TG_WDT_LEVEL_INT_MAP_REG	interrupt map	0x3FF00258	R/W
DPORT_APP_TG_LACT_LEVEL_INT_MAP_REG	interrupt map	0x3FF0025C	R/W
DPORT_APP_TG1_T0_LEVEL_INT_MAP_REG	interrupt map	0x3FF00260	R/W
DPORT_APP_TG1_T1_LEVEL_INT_MAP_REG	interrupt map	0x3FF00264	R/W
DPORT_APP_TG1_WDT_LEVEL_INT_MAP_REG	interrupt map	0x3FF00268	R/W
DPORT_APP_TG1_LACT_LEVEL_INT_MAP_REG	interrupt map	0x3FF0026C	R/W
DPORT_APP_GPIO_INTERRUPT_MAP_REG	interrupt map	0x3FF00270	R/W
DPORT_APP_GPIO_INTERRUPT_NMI_MAP_REG	interrupt map	0x3FF00274	R/W
DPORT_APP_CPU_INTR_FROM_CPU_0_MAP_REG	interrupt map	0x3FF00278	R/W
DPORT_APP_CPU_INTR_FROM_CPU_1_MAP_REG	interrupt map	0x3FF0027C	R/W
DPORT_APP_CPU_INTR_FROM_CPU_2_MAP_REG	interrupt map	0x3FF00280	R/W
DPORT_APP_CPU_INTR_FROM_CPU_3_MAP_REG	interrupt map	0x3FF00284	R/W
DPORT_APP_SPI_INTR_0_MAP_REG	interrupt map	0x3FF00288	R/W
DPORT_APP_SPI_INTR_1_MAP_REG	interrupt map	0x3FF0028C	R/W
DPORT_APP_SPI_INTR_2_MAP_REG	interrupt map	0x3FF00290	R/W
DPORT_APP_SPI_INTR_3_MAP_REG	interrupt map	0x3FF00294	R/W
DPORT_APP_I2S0_INT_MAP_REG	interrupt map	0x3FF00298	R/W
DPORT_APP_I2S1_INT_MAP_REG	interrupt map	0x3FF0029C	R/W
DPORT_APP_UART_INTR_MAP_REG	interrupt map	0x3FF002A0	R/W
DPORT_APP_UART1_INTR_MAP_REG	interrupt map	0x3FF002A4	R/W
DPORT_APP_UART2_INTR_MAP_REG	interrupt map	0x3FF002A8	R/W
DPORT_APP_SDIO_HOST_INTERRUPT_MAP_REG	interrupt map	0x3FF002AC	R/W
DPORT_APP_EMAC_INT_MAP_REG	interrupt map	0x3FF002B0	R/W
DPORT_APP_PWM0_INTR_MAP_REG	interrupt map	0x3FF002B4	R/W
DPORT_APP_PWM1_INTR_MAP_REG	interrupt map	0x3FF002B8	R/W
DPORT_APP_LEDC_INT_MAP_REG	interrupt map	0x3FF002C4	R/W
DPORT_APP_EFUSE_INT_MAP_REG	interrupt map	0x3FF002C8	R/W

Name	Description	Address	Access
DPORT_APP_TWAI_INT_MAP_REG	interrupt map	0x3FF002CC	R/W
DPORT_APP_RTC_CORE_INTR_MAP_REG	interrupt map	0x3FF002D0	R/W
DPORT_APP_RMT_INTR_MAP_REG	interrupt map	0x3FF002D4	R/W
DPORT_APP_PCNT_INTR_MAP_REG	interrupt map	0x3FF002D8	R/W
DPORT_APP_I2C_EXT0_INTR_MAP_REG	interrupt map	0x3FF002DC	R/W
DPORT_APP_I2C_EXT1_INTR_MAP_REG	interrupt map	0x3FF002E0	R/W
DPORT_APP_RSA_INTR_MAP_REG	interrupt map	0x3FF002E4	R/W
DPORT_APP_SPI1_DMA_INT_MAP_REG	interrupt map	0x3FF002E8	R/W
DPORT_APP_SPI2_DMA_INT_MAP_REG	interrupt map	0x3FF002EC	R/W
DPORT_APP_SPI3_DMA_INT_MAP_REG	interrupt map	0x3FF002F0	R/W
DPORT_APP_WDG_INT_MAP_REG	interrupt map	0x3FF002F4	R/W
DPORT_APP_TIMER_INT1_MAP_REG	interrupt map	0x3FF002F8	R/W
DPORT_APP_TIMER_INT2_MAP_REG	interrupt map	0x3FF002FC	R/W
DPORT_APP_TG_T0_EDGE_INT_MAP_REG	interrupt map	0x3FF00300	R/W
DPORT_APP_TG_T1_EDGE_INT_MAP_REG	interrupt map	0x3FF00304	R/W
DPORT_APP_TG_WDT_EDGE_INT_MAP_REG	interrupt map	0x3FF00308	R/W
DPORT_APP_TG_LACT_EDGE_INT_MAP_REG	interrupt map	0x3FF0030C	R/W
DPORT_APP_TG1_T0_EDGE_INT_MAP_REG	interrupt map	0x3FF00310	R/W
DPORT_APP_TG1_T1_EDGE_INT_MAP_REG	interrupt map	0x3FF00314	R/W
DPORT_APP_TG1_WDT_EDGE_INT_MAP_REG	interrupt map	0x3FF00318	R/W
DPORT_APP_TG1_LACT_EDGE_INT_MAP_REG	interrupt map	0x3FF0031C	R/W
DPORT_APP_MMU_IA_INT_MAP_REG	interrupt map	0x3FF00320	R/W
DPORT_APP_MPU_IA_INT_MAP_REG	interrupt map	0x3FF00324	R/W
DPORT_APP_CACHE_IA_INT_MAP_REG	interrupt map	0x3FF00328	R/W
<b>DMA registers</b>			
DPORT_SPI_DMA_CHAN_SEL_REG	selects DMA channel for SPI1, SPI2, and SPI3	0x3FF005A8	R/W
<b>MPU/MMU registers</b>			
DPORT_PRO_CACHE_CTRL_REG	determines the virtual address mode of the external SRAM	0x3FF00040	R/W
DPORT_APP_CACHE_CTRL_REG	determines the virtual address mode of the external SRAM	0x3FF00058	R/W
DPORT_IMMU_PAGE_MODE_REG	page size in the MMU for the internal SRAM 0	0x3FF00080	R/W
DPORT_DMMU_PAGE_MODE_REG	page size in the MMU for the internal SRAM 2	0x3FF00084	R/W
DPORT_AHB_MPU_TABLE_0_REG	MPU for configuring DMA	0x3FF000B4	R/W
DPORT_AHB_MPU_TABLE_1_REG	MPU for configuring DMA	0x3FF000B8	R/W
DPORT_AHBLITE_MPU_TABLE_UART_REG	MPU for peripherals	0x3FF0032C	R/W
DPORT_AHBLITE_MPU_TABLE_SPI1_REG	MPU for peripherals	0x3FF00330	R/W
DPORT_AHBLITE_MPU_TABLE_SPI0_REG	MPU for peripherals	0x3FF00334	R/W

Name	Description	Address	Access
DPORT_AHBLITE_MPU_TABLE_GPIO_REG	MPU for peripherals	0x3FF00338	R/W
DPORT_AHBLITE_MPU_TABLE_RTC_REG	MPU for peripherals	0x3FF00348	R/W
DPORT_AHBLITE_MPU_TABLE_IO_MUX_REG	MPU for peripherals	0x3FF0034C	R/W
DPORT_AHBLITE_MPU_TABLE_HINF_REG	MPU for peripherals	0x3FF00354	R/W
DPORT_AHBLITE_MPU_TABLE_UHCI1_REG	MPU for peripherals	0x3FF00358	R/W
DPORT_AHBLITE_MPU_TABLE_I2S0_REG	MPU for peripherals	0x3FF00364	R/W
DPORT_AHBLITE_MPU_TABLE_UART1_REG	MPU for peripherals	0x3FF00368	R/W
DPORT_AHBLITE_MPU_TABLE_I2C_EXT0_REG	MPU for peripherals	0x3FF00374	R/W
DPORT_AHBLITE_MPU_TABLE_UHCI0_REG	MPU for peripherals	0x3FF00378	R/W
DPORT_AHBLITE_MPU_TABLE_SLCHOST_REG	MPU for peripherals	0x3FF0037C	R/W
DPORT_AHBLITE_MPU_TABLE_RMT_REG	MPU for peripherals	0x3FF00380	R/W
DPORT_AHBLITE_MPU_TABLE_PCNT_REG	MPU for peripherals	0x3FF00384	R/W
DPORT_AHBLITE_MPU_TABLE_SLC_REG	MPU for peripherals	0x3FF00388	R/W
DPORT_AHBLITE_MPU_TABLE_LEDC_REG	MPU for peripherals	0x3FF0038C	R/W
DPORT_AHBLITE_MPU_TABLE_EFUSE_REG	MPU for peripherals	0x3FF00390	R/W
DPORT_AHBLITE_MPU_TABLE_SPI_ENCRYPT_REG	MPU for peripherals	0x3FF00394	R/W
DPORT_AHBLITE_MPU_TABLE_PWM0_REG	MPU for peripherals	0x3FF0039C	R/W
DPORT_AHBLITE_MPU_TABLE_TIMERGROUP_REG	MPU for peripherals	0x3FF003A0	R/W
DPORT_AHBLITE_MPU_TABLE_TIMERGROUP1_REG	MPU for peripherals	0x3FF003A4	R/W
DPORT_AHBLITE_MPU_TABLE_SPI2_REG	MPU for peripherals	0x3FF003A8	R/W
DPORT_AHBLITE_MPU_TABLE_SPI3_REG	MPU for peripherals	0x3FF003AC	R/W
DPORT_AHBLITE_MPU_TABLE_APB_CTRL_REG	MPU for peripherals	0x3FF003B0	R/W
DPORT_AHBLITE_MPU_TABLE_I2C_EXT1_REG	MPU for peripherals	0x3FF003B4	R/W
DPORT_AHBLITE_MPU_TABLE_SDIO_HOST_REG	MPU for peripherals	0x3FF003B8	R/W
DPORT_AHBLITE_MPU_TABLE_EMAC_REG	MPU for peripherals	0x3FF003BC	R/W
DPORT_AHBLITE_MPU_TABLE_PWM1_REG	MPU for peripherals	0x3FF003C4	R/W
DPORT_AHBLITE_MPU_TABLE_I2S1_REG	MPU for peripherals	0x3FF003C8	R/W
DPORT_AHBLITE_MPU_TABLE_UART2_REG	MPU for peripherals	0x3FF003CC	R/W
DPORT_AHBLITE_MPU_TABLE_PWR_REG	MPU for peripherals	0x3FF003E4	R/W
DPORT_IMMU_TABLE0_REG	MMU register 1 for internal SRAM 0	0x3FF00504	R/W
DPORT_IMMU_TABLE1_REG	MMU register 1 for internal SRAM 0	0x3FF00508	R/W
DPORT_IMMU_TABLE2_REG	MMU register 1 for Internal SRAM 0	0x3FF0050C	R/W
DPORT_IMMU_TABLE3_REG	MMU register 1 for internal SRAM 0	0x3FF00510	R/W
DPORT_IMMU_TABLE4_REG	MMU register 1 for internal SRAM 0	0x3FF00514	R/W
DPORT_IMMU_TABLE5_REG	MMU register 1 for internal SRAM 0	0x3FF00518	R/W

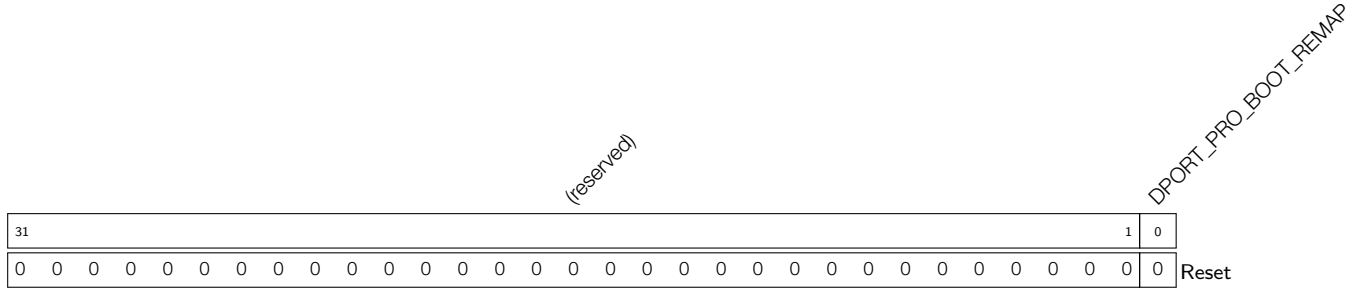
Name	Description	Address	Access
DPORT_IMMU_TABLE6_REG	MMU register 1 for internal SRAM 0	0x3FF0051C	R/W
DPORT_IMMU_TABLE7_REG	MMU register 1 for internal SRAM 0	0x3FF00520	R/W
DPORT_IMMU_TABLE8_REG	MMU register 1 for internal SRAM 0	0x3FF00524	R/W
DPORT_IMMU_TABLE9_REG	MMU register 1 for internal SRAM 0	0x3FF00528	R/W
DPORT_IMMU_TABLE10_REG	MMU register 1 for internal SRAM 0	0x3FF0052C	R/W
DPORT_IMMU_TABLE11_REG	MMU register 1 for internal SRAM 0	0x3FF00530	R/W
DPORT_IMMU_TABLE12_REG	MMU register 1 for Internal SRAM 0	0x3FF00534	R/W
DPORT_IMMU_TABLE13_REG	MMU register 1 for internal SRAM 0	0x3FF00538	R/W
DPORT_IMMU_TABLE14_REG	MMU register 1 for internal SRAM 0	0x3FF0053C	R/W
DPORT_IMMU_TABLE15_REG	MMU register 1 for internal SRAM 0	0x3FF00540	R/W
DPORT_DMMU_TABLE0_REG	MMU register 1 for Internal SRAM 2	0x3FF00544	R/W
DPORT_DMMU_TABLE1_REG	MMU register 1 for internal SRAM 2	0x3FF00548	R/W
DPORT_DMMU_TABLE2_REG	MMU register 1 for internal SRAM 2	0x3FF0054C	R/W
DPORT_DMMU_TABLE3_REG	MMU register 1 for internal SRAM 2	0x3FF00550	R/W
DPORT_DMMU_TABLE4_REG	MMU register 1 for internal SRAM 2	0x3FF00554	R/W
DPORT_DMMU_TABLE5_REG	MMU register 1 for internal SRAM 2	0x3FF00558	R/W
DPORT_DMMU_TABLE6_REG	MMU register 1 for internal SRAM 2	0x3FF0055C	R/W
DPORT_DMMU_TABLE7_REG	MMU register 1 for internal SRAM 2	0x3FF00560	R/W
DPORT_DMMU_TABLE8_REG	MMU register 1 for internal SRAM 2	0x3FF00564	R/W
DPORT_DMMU_TABLE9_REG	MMU register 1 for internal SRAM 2	0x3FF00568	R/W
DPORT_DMMU_TABLE10_REG	MMU register 1 for internal SRAM 2	0x3FF0056C	R/W
DPORT_DMMU_TABLE11_REG	MMU register 1 for internal SRAM 2	0x3FF00570	R/W

Name	Description	Address	Access
DPORT_DMMU_TABLE12_REG	MMU register 1 for internal SRAM 2	0x3FF00574	R/W
DPORT_DMMU_TABLE13_REG	MMU register 1 for internal SRAM 2	0x3FF00578	R/W
DPORT_DMMU_TABLE14_REG	MMU register 1 for internal SRAM 2	0x3FF0057C	R/W
DPORT_DMMU_TABLE15_REG	MMU register 1 for internal SRAM 2	0x3FF00580	R/W
<b>APP_CPU controller registers</b>			
DPORT_APPCPU_CTRL_REG_A_REG	reset for APP_CPU	0x3FF0002C	R/W
DPORT_APPCPU_CTRL_REG_B_REG	clock gate for APP_CPU	0x3FF00030	R/W
DPORT_APPCPU_CTRL_REG_C_REG	stall for APP_CPU	0x3FF00034	R/W
DPORT_APPCPU_CTRL_REG_D_REG	boot address for APP_CPU	0x3FF00038	R/W
<b>Peripheral clock gating and reset registers</b>			
DPORT_PERI_CLK_EN_REG	clock gate for peripherals	0x3FF0001C	R/W
DPORT_PERI_RST_EN_REG	reset for peripherals	0x3FF00020	R/W
DPORT_PERIP_CLK_EN_REG	clock gate for peripherals	0x3FF000C0	R/W
DPORT_PERIP_RST_EN_REG	reset for peripherals	0x3FF000C4	R/W
DPORT_WIFI_CLK_EN_REG	clock gate for Wi-Fi	0x3FF000CC	R/W
DPORT_WIFI_RST_EN_REG	reset for Wi-Fi	0x3FF000D0	R/W

## 5.5 Registers

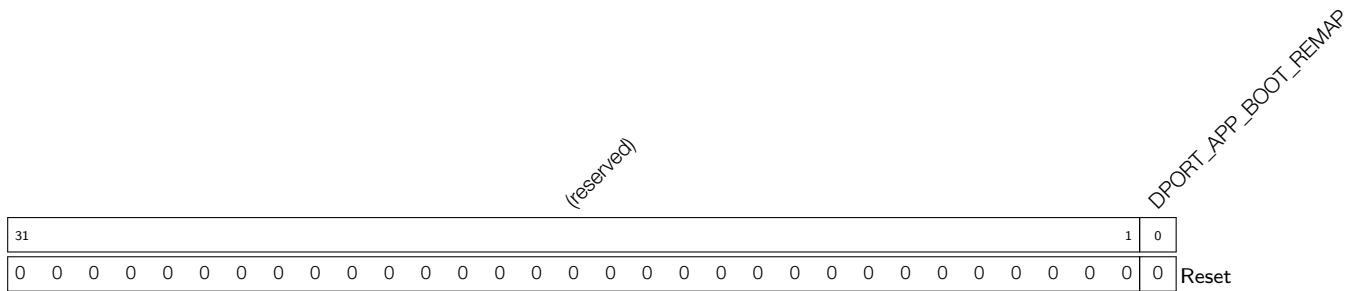
The addresses in this section are relative to DPORT base address (0x3FF00000) provided in Table 1-6 in Chapter 1 *System and Memory*.

**Register 5.1. DPORT\_PRO\_BOOT\_REMAP\_CTRL\_REG (0x000)**



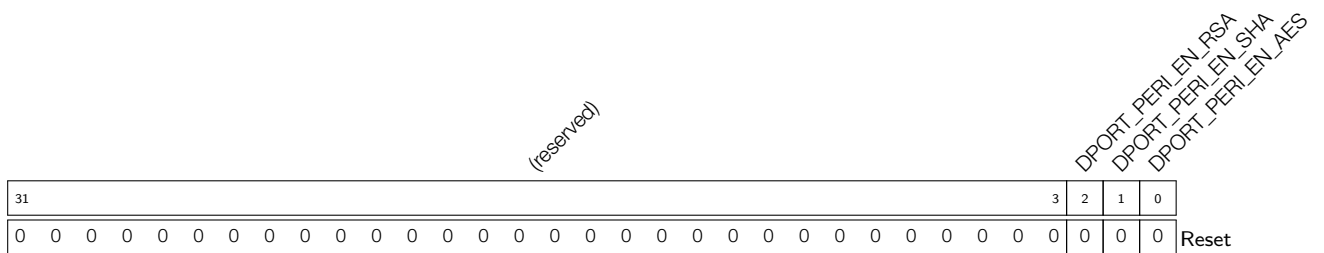
**DPORT\_PRO\_BOOT\_REMAP** Remap mode for PRO\_CPU. (R/W)

**Register 5.2. DPORT\_APP\_BOOT\_REMAP\_CTRL\_REG (0x004)**



**DPORT\_APP\_BOOT\_REMAP** Remap mode for APP\_CPU. (R/W)

**Register 5.3. DPORT\_PERI\_CLK\_EN\_REG (0x01C)**



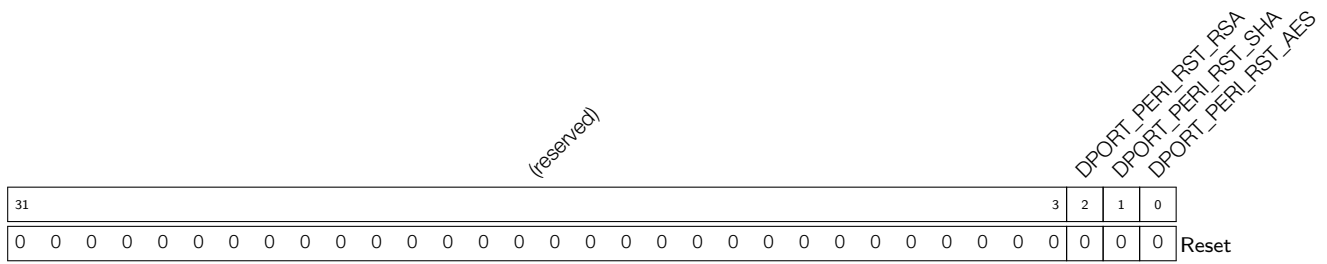
**DPORT\_PERI\_EN\_RSA** Set the bit to enable the clock of RSA module. Clear the bit to disable the clock of RSA module. (R/W)

**DPORT\_PERI\_EN\_SHA** Set the bit to enable the clock of SHA module. Clear the bit to disable the clock of SHA module. (R/W)

**DPORT\_PERI\_EN\_AES** Set the bit to enable the clock of AES module. Clear the bit to disable the clock of AES module. (R/W)



**Register 5.4. DPORT\_PERI\_RST\_EN\_REG (0x020)**

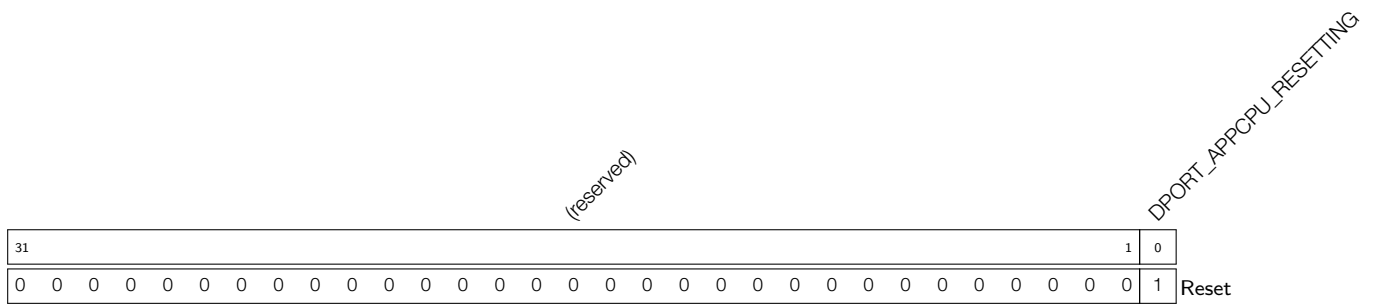


**DPORT\_PERI\_RST\_RSA** Set the bit to reset the clock of RSA module. Clear the bit to release the clock of RSA module. (R/W)

**DPORT\_PERI\_RST\_SHA** Set the bit to reset the clock of SHA module. Clear the bit to release the clock of SHA module. (R/W)

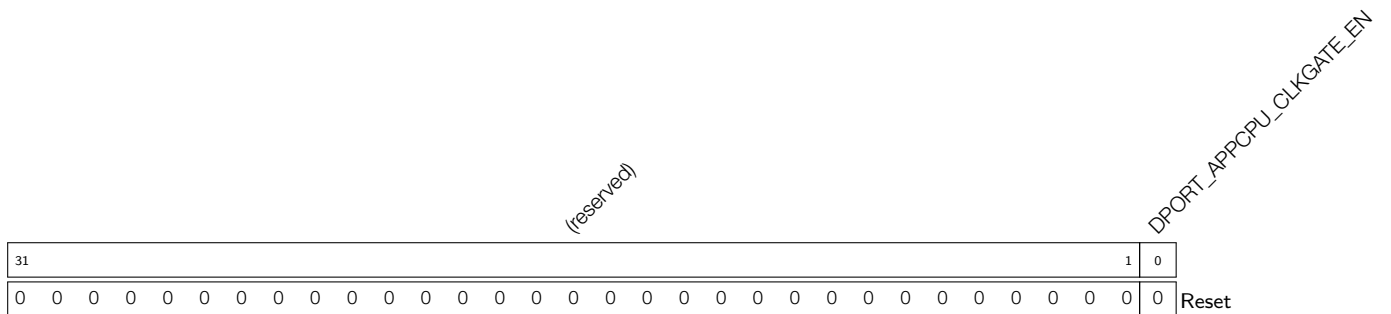
**DPORT\_PERI\_RST\_AES** Set the bit to reset the clock of AES module. Clear the bit to release the clock of AES module. (R/W)

**Register 5.5. DPORT\_APPCPU\_CTRL\_REG\_A\_REG (0x02C)**



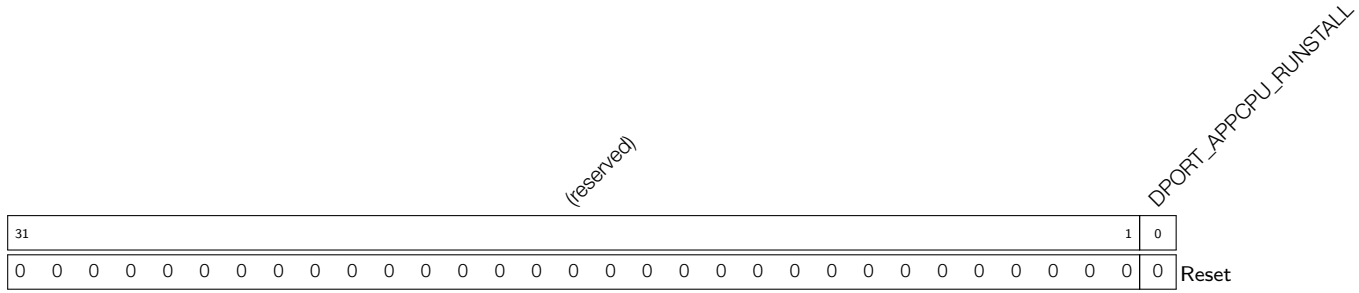
**DPORT\_APPCPU\_RESETTING** Set to 1 to reset APP\_CPU. Clear the bit to release APP\_CPU. (R/W)

**Register 5.6. DPORT\_APPCPU\_CTRL\_REG\_B\_REG (0x030)**



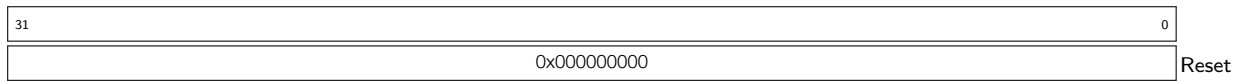
**DPORT\_APPCPU\_CLKGATE\_EN** Set to 1 to enable the clock of APP\_CPU. Clear the bit to disable the clock of APP\_CPU. (R/W)

**Register 5.7. DPORT\_APPCPU\_CTRL\_REG\_C\_REG (0x034)**



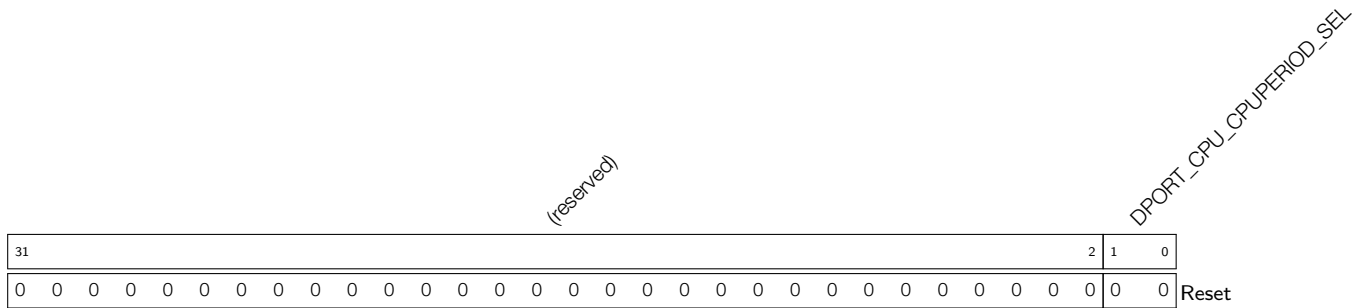
**DPORT\_APPCPU\_RUNSTALL** Set to 1 to put APP\_CPU into stalled state. Clear the bit to release APP\_CPU from stalled state. (R/W)

**Register 5.8. DPORT\_APPCPU\_CTRL\_REG\_D\_REG (0x038)**



**DPORT\_APPCPU\_CTRL\_REG\_D\_REG** When APP\_CPU is booted up with ROM code, it will jump to the address stored in this register. (R/W)

**Register 5.9. DPORT\_CPU\_PER\_CONF\_REG (0x03C)**



**DPORT\_CPU\_CPUPERIOD\_SEL** Select CPU clock. Refer to Table 3-3 for details. (R/W)

## Register 5.10. DPORT\_PRO\_CACHE\_CTRL\_REG (0x040)

(reserved)																	DPORT_PRO_DRAM_HL			(reserved)			DPORT_PRO_DRAM_SPLIT			DPORT_PRO_SINGLE_IRAM_ENA			DPORT_PRO_CACHE_FLUSH_DONE			DPORT_PRO_CACHE_FLUSH_ENA			(reserved)		
31															17	16	15	12	11	10	9				6	5	4	3	2				0				
0	0	0	0	0	0	0	0	0	0	0	0	0	0	0	0	0	0	0	0	0	0	0	0	0	0	0	0	0	0	1	0	0	0	0			

Reset

**DPORT\_PRO\_DRAM\_HL** Determines the virtual address mode of the external SRAM. (R/W)

**DPORT\_PRO\_DRAM\_SPLIT** Determines the virtual address mode of the external SRAM. (R/W)

**DPORT\_PRO\_SINGLE\_IRAM\_ENA** Determines a special mode for PRO\_CPU access to the external flash. (R/W)

**DPORT\_PRO\_CACHE\_FLUSH\_DONE** PRO\_CPU cache-flush done. (RO)

**DPORT\_PRO\_CACHE\_FLUSH\_ENA** Flushes the PRO\_CPU cache. (R/W)

**DPORT\_PRO\_CACHE\_ENABLE** Enables the PRO\_CPU cache. (R/W)

## Register 5.11. DPORT\_APP\_CACHE\_CTRL\_REG (0x058)

(reserved)																	DPORT_APP_DRAM_HL			(reserved)			DPORT_APP_DRAM_SPLIT			DPORT_APP_SINGLE_IRAM_ENA			DPORT_APP_CACHE_FLUSH_DONE			DPORT_APP_CACHE_FLUSH_ENA			(reserved)		
31															15	14	13	12	11	10	9				6	5	4	3	2				0				
0	0	0	0	0	0	0	0	0	0	0	0	0	0	0	0	0	0	0	0	0	0	0	0	0	0	0	0	0	1	0	0	0	0				

Reset

**DPORT\_APP\_DRAM\_HL** Determines the virtual address mode of the External SRAM. (R/W)

**DPORT\_APP\_DRAM\_SPLIT** Determines the virtual address mode of the External SRAM. (R/W)

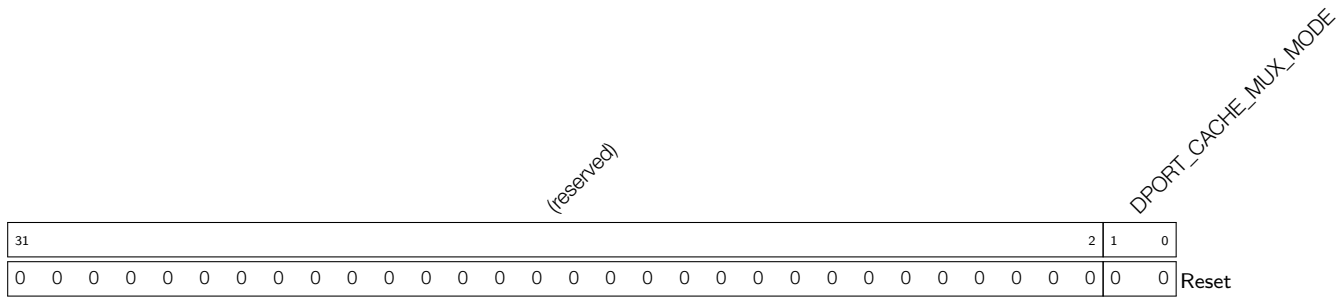
**DPORT\_APP\_SINGLE\_IRAM\_ENA** Determines a special mode for APP\_CPU access to the external flash. (R/W)

**DPORT\_APP\_CACHE\_FLUSH\_DONE** APP\_CPU cache-flush done. (RO)

**DPORT\_APP\_CACHE\_FLUSH\_ENA** Flushes the APP\_CPU cache. (R/W)

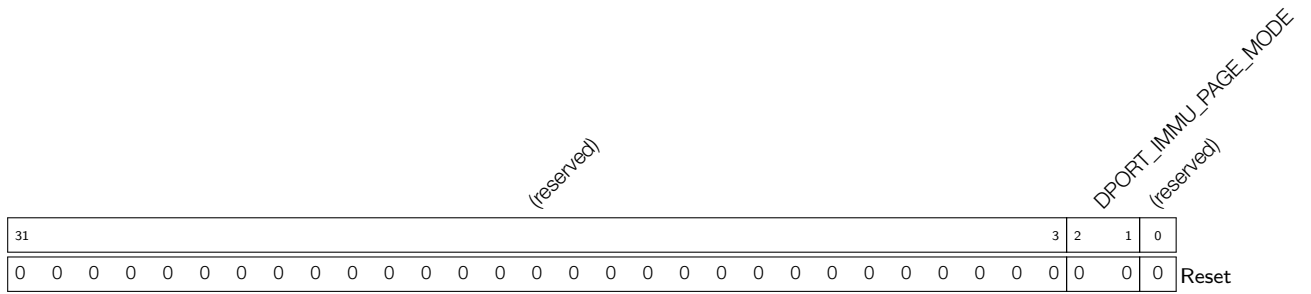
**DPORT\_APP\_CACHE\_ENABLE** Enables the APP\_CPU cache. (R/W)

**Register 5.12. DPORT\_CACHE\_MUX\_MODE\_REG (0x07C)**



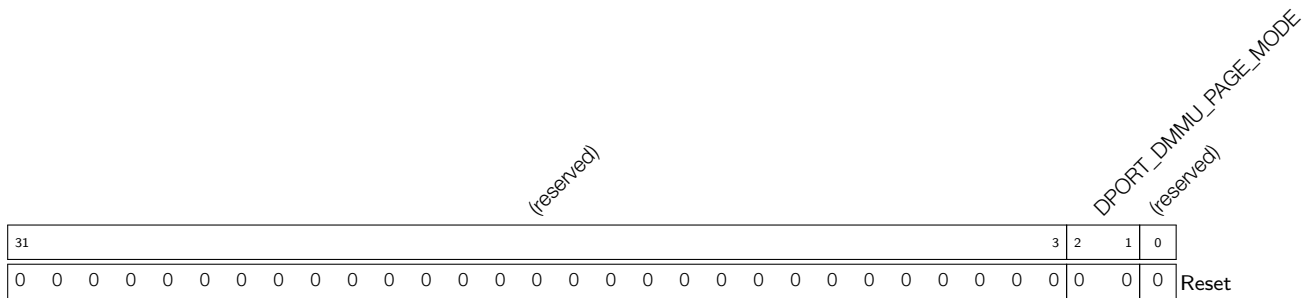
**DPORT\_CACHE\_MUX\_MODE** The mode of the two caches sharing the memory. (R/W)

**Register 5.13. DPORT\_IMMU\_PAGE\_MODE\_REG (0x080)**



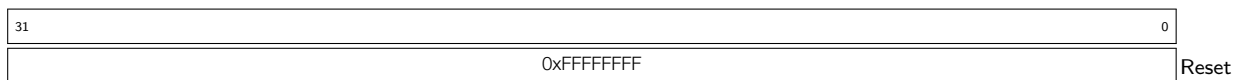
**DPORT\_IMMU\_PAGE\_MODE** Page size in the MMU for the internal SRAM 0. (R/W)

**Register 5.14. DPORT\_DMMU\_PAGE\_MODE\_REG (0x084)**



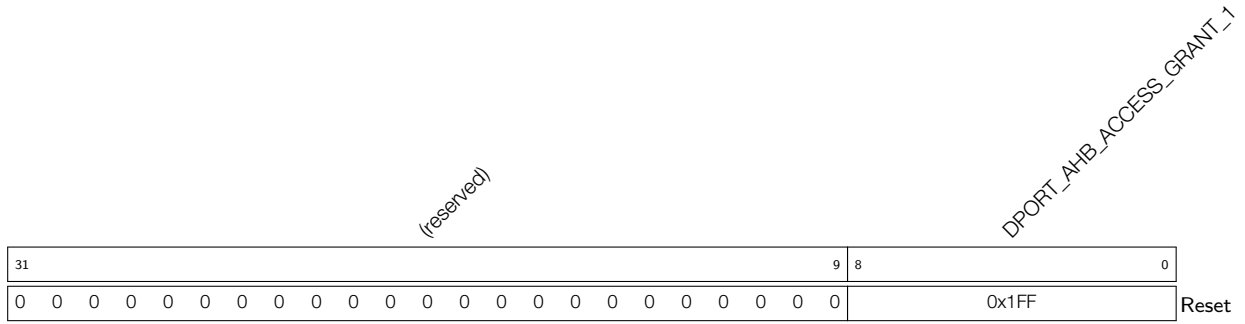
**DPORT\_DMMU\_PAGE\_MODE** Page size in the MMU for the internal SRAM 2. (R/W)

**Register 5.15. DPORT\_AHB\_MPU\_TABLE\_0\_REG (0x0B4)**



**DPORT\_AHB\_MPU\_TABLE\_0\_REG** MPU for DMA. (R/W)

**Register 5.16. DPORT\_AHB\_MPU\_TABLE\_1\_REG (0x0B8)**



**DPORT\_AHB\_ACCESS\_GRANT\_1** MPU for DMA. (R/W)

**Register 5.17. DPORT\_PERIP\_CLK\_EN\_REG (0x0C0)**

31	27	26	25	24	23	22	21	20	19	18	17	16	15	14	13	12	11	10	9	8	7	6	5	4	3	2	1	0	Reset
11111		0	0	1	1	1	0	0	0	0	0	1	1	1	1	0	0	0	0	0	0	0	1	1	0	1	1	1	1

Set the following bit to enable the clock of the corresponding module. Clear the bit to disable the clock of the corresponding module.

**DPORT\_UART\_MEM\_CLK\_EN** Shared memory of UART0 ~ 2. (R/W)

**DPORT\_UART2\_CLK\_EN** UART2 module. (R/W)

**DPORT\_SPI\_DMA\_CLK\_EN** SPI\_DMA module. (R/W)

**DPORT\_I2S1\_CLK\_EN** I2S1 module. (R/W)

**DPORT\_PWM1\_CLK\_EN** PWM1 module. (R/W)

**DPORT\_TWAI\_CLK\_EN** TWAI module. (R/W)

**DPORT\_I2C\_EXT1\_CLK\_EN** I2C1 module. (R/W)

**DPORT\_PWM0\_CLK\_EN** PWM0 module. (R/W)

**DPORT\_SPI3\_CLK\_EN** SPI3 module. (R/W)

**DPORT\_TIMERGROUP1\_CLK\_EN** TIMG1 module. (R/W)

**DPORT\_EFUSE\_CLK\_EN** eFuse module. (R/W)

**DPORT\_TIMERGROUP\_CLK\_EN** TIMG0 module. (R/W)

**DPORT\_UHCI1\_CLK\_EN** UDMA1 module. (R/W)

**DPORT\_LEDC\_CLK\_EN** LEDC module. (R/W)

**DPORT\_PCNT\_CLK\_EN** PCNT module. (R/W)

**DPORT\_RMT\_CLK\_EN** RMT module. (R/W)

**DPORT\_UHCI0\_CLK\_EN** UDMA0 module. (R/W)

**DPORT\_I2C\_EXT0\_CLK\_EN** I2C0 module. (R/W)

**DPORT\_SPI2\_CLK\_EN** SPI2 module. (R/W)

Continued on the next page...





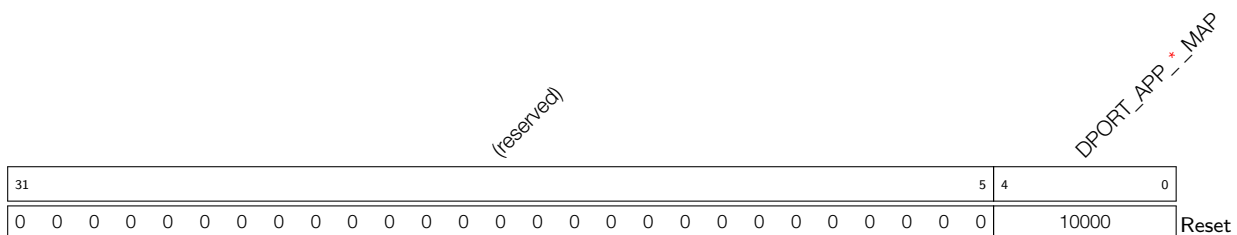


- Register 5.24. DPORT\_PRO\_MAC\_INTR\_MAP\_REG (0x104)
- Register 5.25. DPORT\_PRO\_MAC\_NMI\_MAP\_REG (0x108)
- Register 5.26. DPORT\_PRO\_BB\_INT\_MAP\_REG (0x10C)
- Register 5.27. DPORT\_PRO\_BT\_MAC\_INT\_MAP\_REG (0x110)
- Register 5.28. DPORT\_PRO\_BT\_BB\_INT\_MAP\_REG (0x114)
- Register 5.29. DPORT\_PRO\_BT\_BB\_NMI\_MAP\_REG (0x118)
- Register 5.30. DPORT\_PRO\_RWBT\_IRQ\_MAP\_REG (0x11C)
- Register 5.31. DPORT\_PRO\_RWBLE\_IRQ\_MAP\_REG (0x120)
- Register 5.32. DPORT\_PRO\_RWBT\_NMI\_MAP\_REG (0x124)
- Register 5.33. DPORT\_PRO\_RWBLE\_NMI\_MAP\_REG (0x128)
- Register 5.34. DPORT\_PRO\_SLC0\_INTR\_MAP\_REG (0x12C)
- Register 5.35. DPORT\_PRO\_SLC1\_INTR\_MAP\_REG (0x130)
- Register 5.36. DPORT\_PRO\_UHCI0\_INTR\_MAP\_REG (0x134)
- Register 5.37. DPORT\_PRO\_UHCI1\_INTR\_MAP\_REG (0x138)
- Register 5.38. DPORT\_PRO\_TG\_T0\_LEVEL\_INT\_MAP\_REG (0x13C)
- Register 5.39. DPORT\_PRO\_TG\_T1\_LEVEL\_INT\_MAP\_REG (0x140)
- Register 5.40. DPORT\_PRO\_TG\_WDT\_LEVEL\_INT\_MAP\_REG (0x144)
- Register 5.41. DPORT\_PRO\_TG\_LACT\_LEVEL\_INT\_MAP\_REG (0x148)
- Register 5.42. DPORT\_PRO\_TG1\_T0\_LEVEL\_INT\_MAP\_REG (0x14C)
- Register 5.43. DPORT\_PRO\_TG1\_T1\_LEVEL\_INT\_MAP\_REG (0x150)
- Register 5.44. DPORT\_PRO\_TG1\_WDT\_LEVEL\_INT\_MAP\_REG (0x154)
- Register 5.45. DPORT\_PRO\_TG1\_LACT\_LEVEL\_INT\_MAP\_REG (0x158)
- Register 5.46. DPORT\_PRO\_GPIO\_INTERRUPT\_MAP\_REG (0x15C)
- Register 5.47. DPORT\_PRO\_GPIO\_INTERRUPT\_NMI\_MAP\_REG (0x160)
- Register 5.48. DPORT\_PRO\_CPU\_INTR\_FROM\_CPU\_0\_MAP\_REG (0x164)
- Register 5.49. DPORT\_PRO\_CPU\_INTR\_FROM\_CPU\_1\_MAP\_REG (0x168)
- Register 5.50. DPORT\_PRO\_CPU\_INTR\_FROM\_CPU\_2\_MAP\_REG (0x16C)
- Register 5.51. DPORT\_PRO\_CPU\_INTR\_FROM\_CPU\_3\_MAP\_REG (0x170)
- Register 5.52. DPORT\_PRO\_SPI\_INTR\_0\_MAP\_REG (0x174)
- Register 5.53. DPORT\_PRO\_SPI\_INTR\_1\_MAP\_REG (0x178)
- Register 5.54. DPORT\_PRO\_SPI\_INTR\_2\_MAP\_REG (0x17C)
- Register 5.55. DPORT\_PRO\_SPI\_INTR\_3\_MAP\_REG (0x180)
- Register 5.56. DPORT\_PRO\_I2S0\_INT\_MAP\_REG (0x184)
- Register 5.57. DPORT\_PRO\_I2S1\_INT\_MAP\_REG (0x188)
- Register 5.58. DPORT\_PRO\_UART\_INTR\_MAP\_REG (0x18C)



- Register 5.91. DPORT\_APP\_MAC\_INTR\_MAP\_REG (0x218)
- Register 5.92. DPORT\_APP\_MAC\_NMI\_MAP\_REG (0x21C)
- Register 5.93. DPORT\_APP\_BB\_INT\_MAP\_REG (0x220)
- Register 5.94. DPORT\_APP\_BT\_MAC\_INT\_MAP\_REG (0x224)
- Register 5.95. DPORT\_APP\_BT\_BB\_INT\_MAP\_REG (0x228)
- Register 5.96. DPORT\_APP\_BT\_BB\_NMI\_MAP\_REG (0x22C)
- Register 5.97. DPORT\_APP\_RWBT\_IRQ\_MAP\_REG (0x230)
- Register 5.98. DPORT\_APP\_RWBLE\_IRQ\_MAP\_REG (0x234)
- Register 5.99. DPORT\_APP\_RWBT\_NMI\_MAP\_REG (0x238)
- Register 5.100. DPORT\_APP\_RWBLE\_NMI\_MAP\_REG (0x23C)
- Register 5.101. DPORT\_APP\_SLC0\_INTR\_MAP\_REG (0x240)
- Register 5.102. DPORT\_APP\_SLC1\_INTR\_MAP\_REG (0x244)
- Register 5.103. DPORT\_APP\_UHC10\_INTR\_MAP\_REG (0x248)
- Register 5.104. DPORT\_APP\_UHC11\_INTR\_MAP\_REG (0x24C)
- Register 5.105. DPORT\_APP\_TG\_T0\_LEVEL\_INT\_MAP\_REG (0x250)
- Register 5.106. DPORT\_APP\_TG\_T1\_LEVEL\_INT\_MAP\_REG (0x254)
- Register 5.107. DPORT\_APP\_TG\_WDT\_LEVEL\_INT\_MAP\_REG (0x258)
- Register 5.108. DPORT\_APP\_TG\_LACT\_LEVEL\_INT\_MAP\_REG (0x25C)
- Register 5.109. DPORT\_APP\_TG1\_T0\_LEVEL\_INT\_MAP\_REG (0x260)
- Register 5.110. DPORT\_APP\_TG1\_T1\_LEVEL\_INT\_MAP\_REG (0x264)
- Register 5.111. DPORT\_APP\_TG1\_WDT\_LEVEL\_INT\_MAP\_REG (0x268)
- Register 5.112. DPORT\_APP\_TG1\_LACT\_LEVEL\_INT\_MAP\_REG (0x26C)
- Register 5.113. DPORT\_APP\_GPIO\_INTERRUPT\_MAP\_REG (0x270)
- Register 5.114. DPORT\_APP\_GPIO\_INTERRUPT\_NMI\_MAP\_REG (0x274)
- Register 5.115. DPORT\_APP\_CPU\_INTR\_FROM\_CPU\_0\_MAP\_REG (0x278)
- Register 5.116. DPORT\_APP\_CPU\_INTR\_FROM\_CPU\_1\_MAP\_REG (0x27C)
- Register 5.117. DPORT\_APP\_CPU\_INTR\_FROM\_CPU\_2\_MAP\_REG (0x280)
- Register 5.118. DPORT\_APP\_CPU\_INTR\_FROM\_CPU\_3\_MAP\_REG (0x284)
- Register 5.119. DPORT\_APP\_SPI\_INTR\_0\_MAP\_REG (0x288)
- Register 5.120. DPORT\_APP\_SPI\_INTR\_1\_MAP\_REG (0x28C)
- Register 5.121. DPORT\_APP\_SPI\_INTR\_2\_MAP\_REG (0x290)
- Register 5.122. DPORT\_APP\_SPI\_INTR\_3\_MAP\_REG (0x294)
- Register 5.123. DPORT\_APP\_I2S0\_INT\_MAP\_REG (0x298)
- Register 5.124. DPORT\_APP\_I2S1\_INT\_MAP\_REG (0x29C)
- Register 5.125. DPORT\_APP\_UART\_INTR\_MAP\_REG (0x2A0)

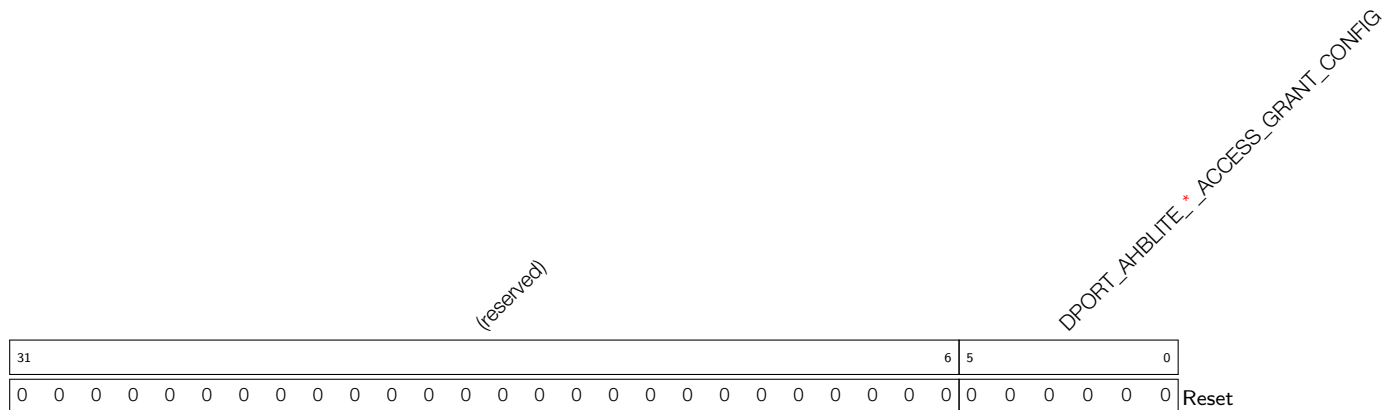
- Register 5.126. DPORT\_APP\_UART1\_INTR\_MAP\_REG (0x2A4)  
 Register 5.127. DPORT\_APP\_UART2\_INTR\_MAP\_REG (0x2A8)  
 Register 5.128. DPORT\_APP\_SDIO\_HOST\_INTERRUPT\_MAP\_REG (0x2AC)  
 Register 5.129. DPORT\_APP\_EMAC\_INT\_MAP\_REG (0x2B0)  
 Register 5.130. DPORT\_APP\_PWM0\_INTR\_MAP\_REG (0x2B4)  
 Register 5.131. DPORT\_APP\_PWM1\_INTR\_MAP\_REG (0x2B8)  
 Register 5.132. DPORT\_APP\_LEDC\_INT\_MAP\_REG (0x2C4)  
 Register 5.133. DPORT\_APP\_EFUSE\_INT\_MAP\_REG (0x2C8)  
 Register 5.134. DPORT\_APP\_TWAI\_INT\_MAP\_REG (0x2CC)  
 Register 5.135. DPORT\_APP\_RTC\_CORE\_INTR\_MAP\_REG (0x2D0)  
 Register 5.136. DPORT\_APP\_RMT\_INTR\_MAP\_REG (0x2D4)  
 Register 5.137. DPORT\_APP\_PCNT\_INTR\_MAP\_REG (0x2D8)  
 Register 5.138. DPORT\_APP\_I2C\_EXT0\_INTR\_MAP\_REG (0x2DC)  
 Register 5.139. DPORT\_APP\_I2C\_EXT1\_INTR\_MAP\_REG (0x2E0)  
 Register 5.140. DPORT\_APP\_RSA\_INTR\_MAP\_REG (0x2E4)  
 Register 5.141. DPORT\_APP\_SPI1\_DMA\_INT\_MAP\_REG (0x2E8)  
 Register 5.142. DPORT\_APP\_SPI2\_DMA\_INT\_MAP\_REG (0x2EC)  
 Register 5.143. DPORT\_APP\_SPI3\_DMA\_INT\_MAP\_REG (0x2F0)  
 Register 5.144. DPORT\_APP\_WDG\_INT\_MAP\_REG (0x2F4)  
 Register 5.145. DPORT\_APP\_TIMER\_INT1\_MAP\_REG (0x2F8)  
 Register 5.146. DPORT\_APP\_TIMER\_INT2\_MAP\_REG (0x2FC)  
 Register 5.147. DPORT\_APP\_TG\_T0\_EDGE\_INT\_MAP\_REG (0x300)  
 Register 5.148. DPORT\_APP\_TG\_T1\_EDGE\_INT\_MAP\_REG (0x304)  
 Register 5.149. DPORT\_APP\_TG\_WDT\_EDGE\_INT\_MAP\_REG (0x308)  
 Register 5.150. DPORT\_APP\_TG\_LACT\_EDGE\_INT\_MAP\_REG (0x30C)  
 Register 5.151. DPORT\_APP\_TG1\_T0\_EDGE\_INT\_MAP\_REG (0x310)  
 Register 5.152. DPORT\_APP\_TG1\_T1\_EDGE\_INT\_MAP\_REG (0x314)  
 Register 5.153. DPORT\_APP\_TG1\_WDT\_EDGE\_INT\_MAP\_REG (0x318)  
 Register 5.154. DPORT\_APP\_TG1\_LACT\_EDGE\_INT\_MAP\_REG (0x31C)  
 Register 5.155. DPORT\_APP\_MMU\_IA\_INT\_MAP\_REG (0x320)  
 Register 5.156. DPORT\_APP\_MPU\_IA\_INT\_MAP\_REG (0x324)  
 Register 5.157. DPORT\_APP\_CACHE\_IA\_INT\_MAP\_REG (0x328)



**DPORT\_APP\*\_MAP** Interrupt map. (R/W)

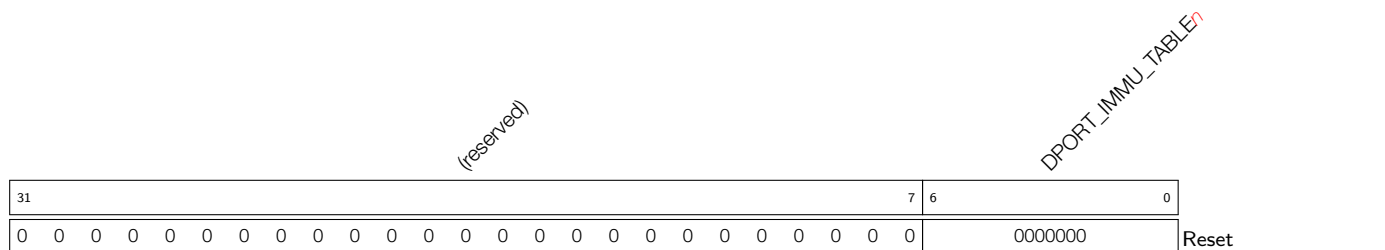
- Register 5.158. DPORT\_AHBLITE\_MPU\_TABLE\_ **UART**\_REG (0x32C)
- Register 5.159. DPORT\_AHBLITE\_MPU\_TABLE\_ **SPI1**\_REG (0x330)
- Register 5.160. DPORT\_AHBLITE\_MPU\_TABLE\_ **SPI0**\_REG (0x334)
- Register 5.161. DPORT\_AHBLITE\_MPU\_TABLE\_ **GPIO**\_REG (0x338)
- Register 5.162. DPORT\_AHBLITE\_MPU\_TABLE\_ **RTC**\_REG (0x348)
- Register 5.163. DPORT\_AHBLITE\_MPU\_TABLE\_ **IO\_MUX**\_REG (0x34C)
- Register 5.164. DPORT\_AHBLITE\_MPU\_TABLE\_ **HINF**\_REG (0x354)
- Register 5.165. DPORT\_AHBLITE\_MPU\_TABLE\_ **UHCI1**\_REG (0x358)
- Register 5.166. DPORT\_AHBLITE\_MPU\_TABLE\_ **I2S0**\_REG (0x364)
- Register 5.167. DPORT\_AHBLITE\_MPU\_TABLE\_ **UART1**\_REG (0x368)
- Register 5.168. DPORT\_AHBLITE\_MPU\_TABLE\_ **I2C\_EXT0**\_REG (0x374)
- Register 5.169. DPORT\_AHBLITE\_MPU\_TABLE\_ **UHCI0**\_REG (0x378)
- Register 5.170. DPORT\_AHBLITE\_MPU\_TABLE\_ **SLCHOST**\_REG (0x37C)
- Register 5.171. DPORT\_AHBLITE\_MPU\_TABLE\_ **RMT**\_REG (0x380)
- Register 5.172. DPORT\_AHBLITE\_MPU\_TABLE\_ **PCNT**\_REG (0x384)
- Register 5.173. DPORT\_AHBLITE\_MPU\_TABLE\_ **SLC**\_REG (0x388)
- Register 5.174. DPORT\_AHBLITE\_MPU\_TABLE\_ **LEDC**\_REG (0x38C)
- Register 5.175. DPORT\_AHBLITE\_MPU\_TABLE\_ **EFUSE**\_REG (0x390)
- Register 5.176. DPORT\_AHBLITE\_MPU\_TABLE\_ **SPI\_ENCRYPT**\_REG (0x394)
- Register 5.177. DPORT\_AHBLITE\_MPU\_TABLE\_ **PWM0**\_REG (0x39C)
- Register 5.178. DPORT\_AHBLITE\_MPU\_TABLE\_ **TIMERGROUP**\_REG (0x3A0)
- Register 5.179. DPORT\_AHBLITE\_MPU\_TABLE\_ **TIMERGROUP1**\_REG (0x3A4)
- Register 5.180. DPORT\_AHBLITE\_MPU\_TABLE\_ **SPI2**\_REG (0x3A8)
- Register 5.181. DPORT\_AHBLITE\_MPU\_TABLE\_ **SPI3**\_REG (0x3AC)
- Register 5.182. DPORT\_AHBLITE\_MPU\_TABLE\_ **APB\_CTRL**\_REG (0x3B0)
- Register 5.183. DPORT\_AHBLITE\_MPU\_TABLE\_ **I2C\_EXT1**\_REG (0x3B4)
- Register 5.184. DPORT\_AHBLITE\_MPU\_TABLE\_ **SDIO\_HOST**\_REG (0x3B8)
- Register 5.185. DPORT\_AHBLITE\_MPU\_TABLE\_ **EMAC**\_REG (0x3BC)
- Register 5.186. DPORT\_AHBLITE\_MPU\_TABLE\_ **PWM1**\_REG (0x3C4)
- Register 5.187. DPORT\_AHBLITE\_MPU\_TABLE\_ **I2S1**\_REG (0x3C8)
- Register 5.188. DPORT\_AHBLITE\_MPU\_TABLE\_ **UART2**\_REG (0x3CC)

**Register 5.189. DPORT\_AHBLITE\_MPU\_TABLE\_PWR\_REG (0x3E4)**



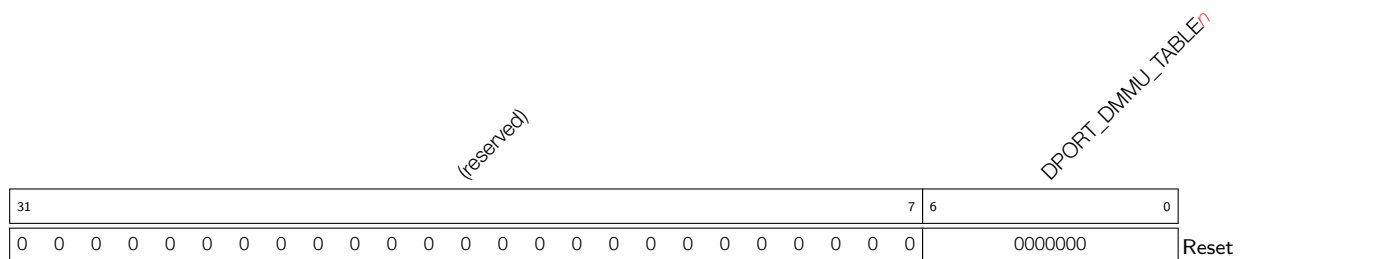
**DPORT\_AHBLITE\*\_ACCESS\_GRANT\_CONFIG** MPU for peripherals. (R/W)

**Register 5.190. DPORT\_IMMU\_TABLE<sub>n</sub>\_REG (n: 0-15) (0x504+4\*n)**



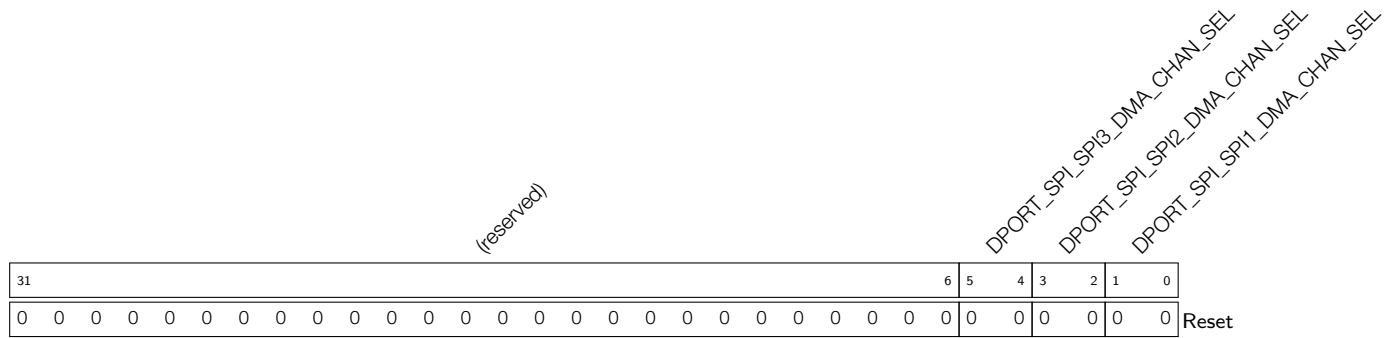
**DPORT\_IMMU\_TABLE<sub>n</sub>** MMU for internal SRAM. When *n* is 0 ~ 9, the reset value is 0. When *n* is 10 ~ 15, the reset value is 10, 11, 12, 13, 14, 15, respectively. (R/W)

**Register 5.191. DPORT\_DMMU\_TABLE<sub>n</sub>\_REG (n: 0-15) (0x544+4\*n)**



**DPORT\_DMMU\_TABLE<sub>n</sub>** MMU for internal SRAM. When *n* is 0 ~ 15, the reset value is 0 ~ 15, respectively. (R/W)

## Register 5.192. DPORT\_SPI\_DMA\_CHAN\_SEL\_REG (0x5A8)



**DPORT\_SPI\_SPI3\_DMA\_CHAN\_SEL** Selects DMA channel for SPI3. (R/W)

**DPORT\_SPI\_SPI2\_DMA\_CHAN\_SEL** Selects DMA channel for SPI2. (R/W)

**DPORT\_SPI\_SPI1\_DMA\_CHAN\_SEL** Selects DMA channel for SPI1. (R/W)

## 6 DMA Controller (DMA)

### 6.1 Overview

Direct Memory Access (DMA) is used for high-speed data transfer between peripherals and memory, as well as from memory to memory. Data can be quickly moved with DMA without any CPU intervention, thus allowing for more efficient use of the cores when processing data.

In the ESP32, 13 peripherals are capable of using DMA for data transfer, namely, UART0, UART1, UART2, SPI1, SPI2, SPI3, I2S0, I2S1, SDIO slave, SD/MMC host, EMAC, BT, and Wi-Fi.

### 6.2 Features

The DMA controllers in the ESP32 feature:

- AHB bus architecture
- Support for full-duplex and half-duplex data transfers
- Programmable data transfer length in bytes
- Support for 4-beat burst transfer
- 328 KB DMA address space
- All high-speed communication modules powered by DMA

### 6.3 Functional Description

All modules that require high-speed data transfer in bulk contain a DMA controller. DMA addressing uses the same data bus as the CPU to read/write to the internal RAM.

Each DMA controller features different functions. However, the architecture of the DMA engine (DMA\_ENGINE) is the same in all DMA controllers.

#### 6.3.1 DMA Engine Architecture

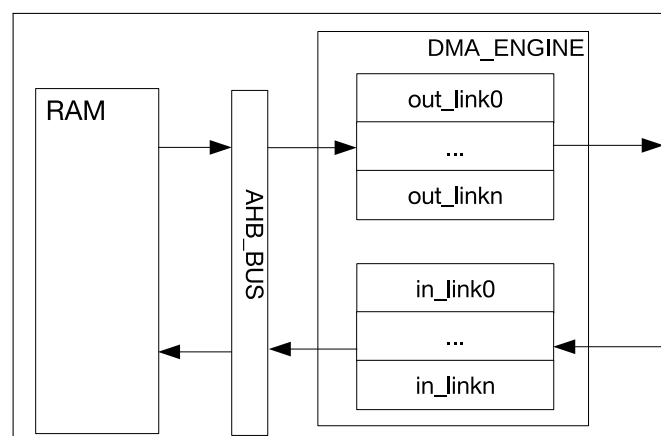


Figure 6-1. DMA Engine Architecture

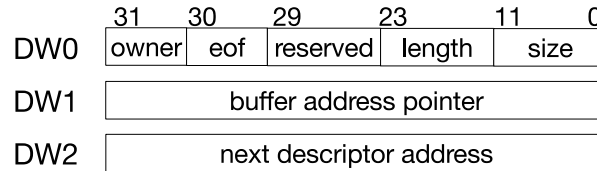
The DMA Engine accesses SRAM over the AHB BUS. In Figure 6-1, the RAM represents the internal SRAM banks available on ESP32. Further details on the SRAM addressing range can be found in Chapter [System and Memory](#).



Software can use a DMA Engine by assigning a linked list to define the DMA operational parameters.

The DMA Engine transmits the data from the RAM to a peripheral, according to the contents of the out\_link descriptor. Also, the DMA Engine stores the data received from a peripheral into a specified RAM location, according to the contents of the in\_link descriptor.

### 6.3.2 Linked List



**Figure 6-2. Linked List Structure**

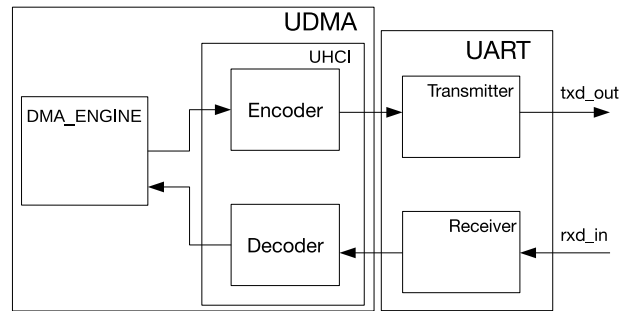
The DMA descriptor's linked lists (out\_link and in\_link) have the same structure. As shown in Figure 6-2, a linked-list descriptor consists of three words. The meaning of each field is as follows:

- owner (DW0) [31]: The allowed operator of the buffer corresponding to the current linked list.
  - 1'b0: the allowed operator is the CPU;
  - 1'b1: the allowed operator is the DMA controller.
- eof (DW0) [30]: End-Of-File character.
  - 1'b0: the linked-list item does not mark the end of the linked list;
  - 1'b1: the linked-list item is at the end of the linked list.
- reserved (DW0) [29:24]: Reserved bits.
  - Software should not write 1's in this space.
- length (DW0) [23:12]: The number of valid bytes in the buffer corresponding to the current linked list. The field value indicates the number of bytes to be transferred to/from the buffer denoted by word DW1.
- size (DW0) [11:0]: The size of the buffer corresponding to the current linked list.
  - NOTE:** The size must be word-aligned.
- buffer address pointer (DW1): Buffer address pointer. This is the address of the data buffer.
  - NOTE:** The buffer address must be word-aligned.
- next descriptor address (DW2): The address pointer of the next linked-list item. The value is 0, if the current linked-list item is the last on the list (eof=1).

When receiving data, if the data transfer length is smaller than the specified buffer size, DMA will not use the remaining space. This enables the DMA engine to be used for transferring an arbitrary number of data bytes.

## 6.4 UART DMA (UDMA)

The ESP32 has three UART interfaces that share two UDMA (UART DMA) controllers. The UHCI\_UART $x$ \_CE ( $x$  is 0, 1, or 2) is used for selecting the UART controller to use the UDMA.



**Figure 6-3. Data Transfer in UDMA Mode**

Figure 6-3 shows the data transfer in UDMA mode. Before the DMA Engine receives data, software must initialize the receive-linked-list. `UHCI_INLINK_ADDR` is used to point to the first `in_link` descriptor. The register must be programmed with the lower 20 bits of the address of the initial linked-list item. After `UHCI_INLINK_START` is set, the Universal Host Controller Interface (UHCI) will transmit the data received by UART to the Decoder. After being parsed, the data will be stored in the RAM as specified by the receive-linked-list descriptor.

Before DMA transmits data, software must initialize the transmit-linked-list and the data to be transferred. `UHCI_OUTLINK_ADDR` is used to point to the first `out_link` descriptor. The register must be programmed with the lower 20 bits of the address of the initial transmit-linked-list item. After `UHCI_OUTLINK_START` is set, the DMA Engine will read data from the RAM location specified by the linked-list descriptor and then transfer the data through the Encoder. The DMA Engine will then shift the data out serially through the UART transmitter.

The UART DMA follows a format of (separator + data + separator). The Encoder is used for adding separators before and after data, as well as using special-character sequences to replace data that are the same as separators. The Decoder is used for removing separators before and after data, as well as replacing the special-character sequences with separators. There can be multiple consecutive separators marking the beginning or end of data. These separators can be configured through `UHCI_SEPER_CH`, with the default values being `0xC0`. Data that are the same as separators can be replaced with `UHCI_ESC_SEQ0_CHAR0` (`0xDB` by default) and `UHCI_ESC_SEQ0_CHAR1` (`0xDD` by default). After the transmission process is complete, a `UHCI_OUT_TOTAL_EOF_INT` interrupt will be generated. After the reception procedure is complete, a `UHCI_IN_SUC_EOF_INT` interrupt will be generated.

**Note:**

Please note that the buffer address pointer field in `in_link` descriptors should be word-aligned, and the size field in the last `in_link` descriptor should be at least 4 bytes larger than the length of received data.

## 6.5 SPI DMA Interface

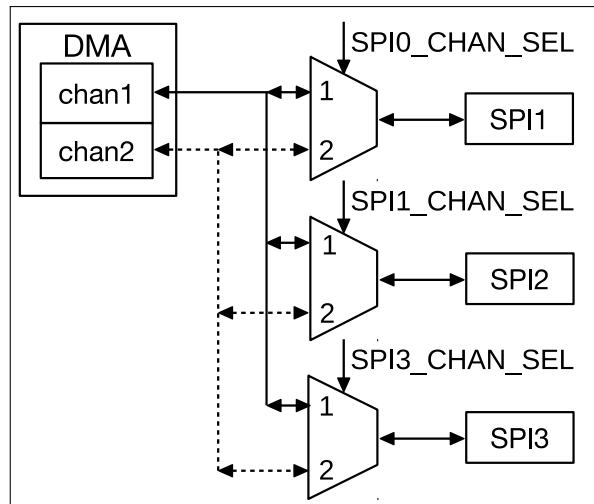


Figure 6-4. SPI DMA

ESP32 SPI modules can use DMA as well as the CPU for data exchange with peripherals. As can be seen from Figure 6-4, two DMA channels are shared by SPI1, SPI2 and SPI3 controllers. Each DMA channel can be used by any one SPI controller at any given time.

The ESP32 SPI DMA Engine also uses a linked list to receive/transmit data. Burst transmission is supported. The minimum data length for a single transfer is one byte. Consecutive data transfer is also supported.

`SPI1_DMA_CHAN_SEL[1:0]`, `SPI2_DMA_CHAN_SEL[1:0]` and `SPI3_DMA_CHAN_SEL[1:0]` in `DPORT_SPI_DMA_CHAN_SEL_REG` must be configured to enable the SPI DMA interface for a specific SPI controller. Each SPI controller corresponds to one domain which has two bits with values 0, 1 and 2. Value 3 is reserved and must not be configured for operation.

Considering SPI1 as an example,

if `SPI1_DMA_CHAN_SEL[1:0] = 0`, then SPI1 does not use any DMA channel;

if `SPI1_DMA_CHAN_SEL[1:0] = 1`, then SPI1 enables DMA channel1;

if `SPI1_DMA_CHAN_SEL[1:0] = 2`, then SPI1 enables DMA channel2.

The `SPI_OUTLINK_START` bit in `SPI_DMA_OUT_LINK_REG` and the `SPI_INLINK_START` bit in `SPI_DMA_IN_LINK_REG` are used for enabling the DMA Engine. The two bits are self-cleared by hardware. When `SPI_OUTLINK_START` is set to 1, the DMA Engine starts processing the outbound linked list descriptor and prepares to transmit data. When `SPI_INLINK_START` is set to 1, then the DMA Engine starts processing the inbound linked-list descriptor and gets prepared to receive data.

Software should configure the SPI DMA as follows:

1. Reset the DMA state machine and FIFO parameters;
2. Configure the DMA-related registers for operation;
3. Configure the SPI-controller-related registers accordingly;
4. Set `SPI_USR` to enable DMA operation.

## 6.6 I2S DMA Interface

The ESP32 integrates two I2S modules, I2S0 and I2S1, each of which is powered by a DMA channel. The REG\_I2S\_DSCR\_EN bit in I2S\_FIFO\_CONF\_REG is used for enabling the DMA operation. ESP32 I2S DMA uses the standard linked-list descriptor to configure DMA operations for data transfer. Burst transfer is supported. However, unlike the SPI DMA channels, the data size for a single transfer is one word, or four bytes. REG\_I2S\_RX\_EOF\_NUM[31:0] bit in I2S\_RXEOF\_NUM\_REG is used for configuring the data size of a single transfer operation, in multiples of one word.

I2S\_OUTLINK\_START bit in I2S\_OUT\_LINK\_REG and I2S\_INLINK\_START bit in I2S\_IN\_LINK\_REG are used for enabling the DMA Engine and are self-cleared by hardware. When I2S\_OUTLINK\_START is set to 1, the DMA Engine starts processing the outbound linked-list descriptor and gets prepared to send data. When I2S\_INLINK\_START is set to 1, the DMA Engine starts processing the inbound linked-list descriptor and gets prepared to receive data.

Software should configure the I2S DMA as follows:

1. Configure I2S-controller-related registers;
2. Reset the DMA state machine and FIFO parameters;
3. Configure DMA-related registers for operation;
4. In I2S master mode, set I2S\_TX\_START bit or I2S\_RX\_START bit to initiate an I2S operation;  
In I2S slave mode, set I2S\_TX\_START bit or I2S\_RX\_START bit and wait for data transfer to be initiated by the host device.

For more information on I2S DMA interrupts, please see Section [DMA Interrupts](#), in Chapter [I2S](#).

## 7 SPI Controller (SPI)

### 7.1 Overview

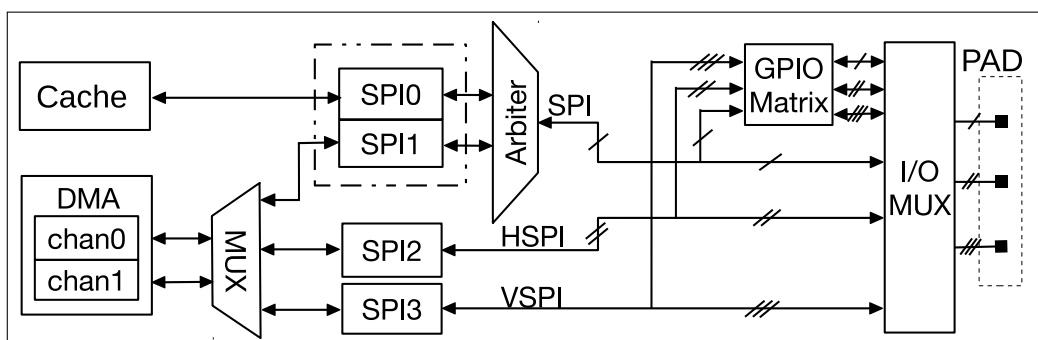


Figure 7-1. SPI Architecture

As Figure 7-1 shows, ESP32 integrates four SPI controllers which can be used to communicate with external devices that use the SPI protocol. Controller SPI0 is used as a buffer for accessing external memory. Controller SPI1 can be used as a master. Controllers SPI2 and SPI3 can be configured as either a master or a slave. When used as a master, each SPI controller can drive multiple CS signals (CS0 ~ CS2) to activate multiple slaves. Controllers SPI1 ~ SPI3 share two DMA channels.

The SPI signal buses consist of D, Q, CS0-CS2, CLK, WP, and HD signals, as Table 7-1 shows. Controllers SPI0 and SPI1 share one signal bus through an arbiter; the signals of the shared bus start with "SPI". Controllers SPI2 and SPI3 use signal buses starting with "HSPI" and "VSPI" respectively. The I/O lines included in the above-mentioned signal buses can be mapped to pins via either the IO\_MUX module or the GPIO matrix. (Please refer to Chapter IO\_MUX for details.)

The SPI controller supports four-line full-duplex/half-duplex communication (MOSI, MISO, CS, and CLK lines) and three-line half-duplex-only communication (DATA, CS, and CLK lines) in GP-SPI mode. In QSPI mode, an SPI controller accesses the flash or SRAM by using signal buses D, Q, CS0 ~ CS2, CLK, WP, and HD as a four-bit parallel SPI bus. The mapping between SPI bus signals and pin function signals under different communication modes is shown in Table 7-1.

Table 7-1. Mapping Between SPI Bus Signals and Pin Function Signals

Four-line GP-SPI Full-duplex/half- duplex signal bus	Three-line GP-SPI Half-duplex signal bus	QSPI Signal bus	Pin function signals		
			SPI signal bus	HSPI signal bus	VSPI signal bus
MOSI	DATA	D	SPID	HSPID	VSPID
MISO	-	Q	SPIQ	HSPIQ	VSPIQ
CS	CS	CS	SPICCS0	HSPICCS0	VSPICCS0
CLK	CLK	CLK	SPICLK	HSPICLK	VSPICLK
-	-	WP	SPIWP	HSPIWP	VSPIWP
-	-	HD	SPIHD	HSPIHD	VSPIHD

## 7.2 SPI Features

### General Purpose SPI (GP-SPI)

- Programmable data transfer length, in multiples of 1 byte
- Four-line full-duplex/half-duplex communication and three-line half-duplex communication support
- Master mode and slave mode
- Programmable CPOL and CPHA
- Programmable clock

### Parallel QSPI

- Communication format support for specific slave devices such as flash
- Programmable communication format
- Six variations of flash-read operations available
- Automatic shift between flash and SRAM access
- Automatic wait states for flash access

### SPI DMA Support

- Support for sending and receiving data using linked lists

### SPI Interrupt Hardware

- SPI interrupts
- SPI DMA interrupts

## 7.3 GP-SPI

The SPI master mode supports four-line full-duplex/half-duplex communication and three-line half-duplex communication. Figure 7-2 outlines the connections needed for four-line full-duplex/half-duplex communications.

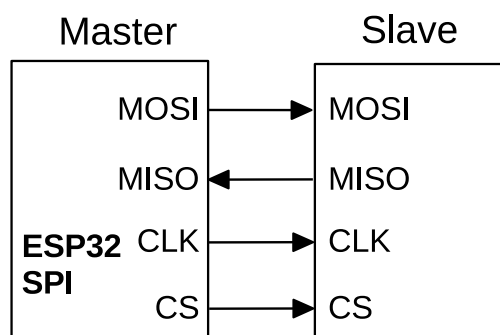


Figure 7-2. SPI Master and Slave Full-duplex/Half-duplex Communication

The SPI1 ~ SPI3 controllers can communicate with other slaves as a standard SPI master. SPI2 and SPI3 can be configured as either a master or a slave. Every SPI master can be connected to three slaves at most by default. When not using DMA, the maximum length of data received/sent in one burst is 64 bytes. The data length is in multiples of one byte.

**Table 7-2. Command Definitions Supported by GP-SPI Slave in Half-duplex Mode**

Command	Description
0x1	Received by slave; writes data sent by the master into the slave status register via MOSI.
0x2	Received by slave; writes data sent by the master into the slave data buffer via MOSI.
0x3	Sent by slave; sends data in the slave buffer to master via MISO.
0x4	Sent by slave; sends data in the slave status register to master via MISO.
0x6	Writes master data on MOSI into data buffer and then sends the data in the slave data buffer to MISO.

### 7.3.1 GP-SPI Four-line Full-duplex Communication

When configured to four-line full-duplex mode, the ESP32 SPI can act as either a master or a slave. The length of received and sent data needs to be set by configuring the SPI\_MISO\_DLEN\_REG, SPI\_MOSI\_DLEN\_REG registers for master mode as well as SPI\_SLV\_RDBUF\_DLEN\_REG, SPI\_SLV\_WRBUF\_DLEN\_REG registers for slave mode. The SPI\_DOUTDIN bit and SPI\_USR\_MOSI bit in register SPI\_USER\_REG should be configured to enable this communication mode. The SPI\_USR bit in register SPI\_CMD\_REG needs to be configured to initialize a data transfer.

### 7.3.2 GP-SPI Four-line Half-duplex Communication

When configured to four-line half-duplex mode, the ESP32 SPI can act as either a master or a slave. In this mode, the SPI communication supports flexible communication format as: command + address + dummy phase + received and/or sent data. The format is specified as follows:

1. command: length of 0 ~ 16 bits; Master Out Slave In (MOSI).
2. address: length of 0 ~ 32/64 bits; Master Out Slave In (MOSI).
3. dummy phase: length of 0 ~ 256 SPI clocks.
4. received and/or sent data: length of 0 ~ 512 bits (64 bytes); Master Out Slave In (MOSI) or Master In Slave Out (MISO).

The address length is up to 32 bits in GP-SPI master mode and 64 bits in QSPI master mode. The command phase, address phase, dummy phase and received/sent data phase are controlled by bits SPI\_USR\_COMMAND, SPI\_USR\_ADDR, SPI\_USR\_DUMMY and SPI\_USR\_MISO/SPI\_USR\_MOSI respectively in register SPI\_USER\_REG. A certain phase is enabled only when its corresponding control bit is set to 1. Details can be found in [register description](#). When SPI works as a master, the register can be configured by software as required to determine whether or not to enable a certain phase.

When SPI works as a slave, the communication format must contain command, address, received and/or sent data, among which the command has several options listed in Table 7-2. During data transmission or reception, the CS signal should keep logic level low. If the CS signal is pulled up during transmission, the internal state of the slave will be reset.

The master can write the slave status register SPI\_SLV\_WR\_STATUS\_REG, and decide whether to read data from register SPI\_SLV\_WR\_STATUS\_REG or register SPI\_RD\_STATUS\_REG via the SPI\_SLV\_STATUS\_READBACK bit in register SPI\_SLAVE1\_REG. The SPI master can maintain communication with the slave by reading and writing slave status register, thus realizing complex communication with ease.

The length of received and sent data is controlled by SPI\_MISO\_DLEN\_REG and SPI\_MOSI\_DLEN\_REG in master mode, as well as SPI\_SLV\_RDBUF\_DLEN\_REG and SPI\_SLV\_WRBUF\_DLEN\_REG in slave mode. A reception or

transmission of data is controlled by bit SPI\_USR\_MOSI or SPI\_USR\_MISO in SPI\_USER\_REG. The SPI\_USR bit in register SPI\_CMD\_REG needs to be configured to initialize a data transfer.

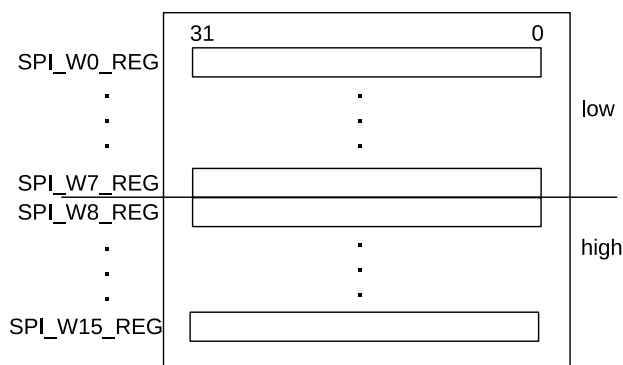
### 7.3.3 GP-SPI Three-line Half-duplex Communication

The three-line half-duplex communication differs from four-line half-duplex communication in that the reception and transmission shares one signal bus and that the communication format must contain command, address, received and/or sent data. Software can enable three-line half-duplex communication by configuring SPI\_SIO bit in SPI\_USER\_REG register.

**Note:**

- In half-duplex communication, the order of command, address, received and/or sent data in the communication format should be followed strictly.
- In half-duplex communication, communication formats "command + address + received data + sent data" and "received data + sent data" are not applicable to DMA.
- When ESP32 SPI acts as a slave, the master CS should be active at least one SPI clock period before a read/write process is initiated, and should be inactive at least one SPI clock period after the read/write process is completed.

### 7.3.4 GP-SPI Data Buffer



**Figure 7-3. SPI Data Buffer**

ESP32 SPI has  $16 \times 32$  bits of data buffer to buffer data-send and data-receive operations. As is shown in Figure 7-3, received data is written from the low byte of SPI\_W0\_REG by default and the writing ends with SPI\_W15\_REG. If the data length is over 64 bytes, the extra part will be written from SPI\_W0\_REG.

Data buffer blocks SPI\_W0\_REG ~ SPI\_W7\_REG and SPI\_W8\_REG ~ SPI\_W15\_REG data correspond to the lower part and the higher part respectively. They can be used separately, and are controlled by the SPI\_USR\_MOSI\_HIGHPART bit and the SPI\_USR\_MISO\_HIGHPART bit in register SPI\_USER\_REG. For example, if SPI is configured as a master, when SPI\_USR\_MOSI\_HIGHPART = 1, SPI\_W8\_REG ~ SPI\_W15\_REG are used as buffer for sending data; when SPI\_USR\_MISO\_HIGHPART = 1, SPI\_W8\_REG ~ SPI\_W15\_REG are used as buffer for receiving data. If SPI acts as a slave, when SPI\_USR\_MOSI\_HIGHPART = 1, SPI\_W8\_REG ~ SPI\_W15\_REG are used as buffer for receiving data; when SPI\_USR\_MISO\_HIGHPART = 1, SPI\_W8\_REG ~ SPI\_W15\_REG are used as buffer for sending data.



**Table 7-3. Clock Polarity and Phase, and Corresponding SPI Register Values for SPI Master**

Registers	mode0	mode1	mode2	mode3
SPI_CK_IDLE_EDGE	0	0	1	1
SPI_CK_OUT_EDGE	0	1	1	0
SPI_MISO_DELAY_MODE	2(0)	1(0)	1(0)	2(0)
SPI_MISO_DELAY_NUM	0	0	0	0
SPI_MOSI_DELAY_MODE	0	0	0	0
SPI_MOSI_DELAY_NUM	0	0	0	0

## 7.4 GP-SPI Clock Control

The maximum output clock frequency of ESP32 GP-SPI master is  $f_{apb}/2$ , and the maximum input clock frequency of the ESP32 GP-SPI slave is  $f_{apb}/8$ . The master can derive other clock frequencies via frequency division.

$$f_{spi} = \frac{f_{apb}}{(SPI\_CLKCNT\_N+1)(SPI\_CLKDIV\_PRE+1)}$$

SPI\_CLKCNT\_N and SPI\_CLKDIV\_PRE are two bits of register SPI\_CLOCK\_REG (Please refer to 7.7 Register Description for details).  $SPI\_CLKCNT\_H = \lfloor \frac{SPI\_CLKCNT\_N+1}{2} - 1 \rfloor$ , SPI\_CLKCNT\_N=SPI\_CLKCNT\_L. When the SPI\_CLK\_EQU\_SYSCLK bit in register SPI\_CLOCK\_REG is set to 1, and the other bits are set to 0, SPI output clock frequency is  $f_{apb}$ . For other clock frequencies, SPI\_CLK\_EQU\_SYSCLK needs to be 0. In slave mode, SPI\_CLKCNT\_N, SPI\_CLKCNT\_L, SPI\_CLKCNT\_H and SPI\_CLKDIV\_PRE should all be 0.

### 7.4.1 GP-SPI Clock Polarity (CPOL) and Clock Phase (CPHA)

The clock polarity and clock phase of ESP32 SPI are controlled by SPI\_CK\_IDLE\_EDGE bit in register SPI\_PIN\_REG, SPI\_CK\_OUT\_EDGE bit and SPI\_CK\_I\_EDGE bit in register SPI\_USER\_REG, as well as SPI\_MISO\_DELAY\_MODE[1:0] bit, SPI\_MISO\_DELAY\_NUM[2:0] bit, SPI\_MOSI\_DELAY\_MODE[1:0] bit, SPI\_MOSI\_DELAY\_NUM[2:0] bit in register SPI\_CTRL2\_REG. Table 7-3 and Table 7-4 show the clock polarity and phase as well as the corresponding register values for ESP32 SPI master and slave, respectively. Note that for mode0 and mode2 in Table 7-4, the registers are configured differently in non-DMA mode and DMA mode, and that the SPI slave data is output in advance in DMA mode.

**Table 7-4. Clock Polarity and Phase, and Corresponding SPI Register Values for SPI Slave**

Registers	mode0		mode1	mode2		mode3
	Non-DMA	DMA		Non-DMA	DMA	
SPI_CK_IDLE_EDGE	1	0	1	0	1	0
SPI_CK_I_EDGE	0	1	1	1	0	0
SPI_MISO_DELAY_MODE	0	0	2	0	0	1
SPI_MISO_DELAY_NUM	0	2	0	0	2	0
SPI_MOSI_DELAY_MODE	2	0	0	1	0	0
SPI_MOSI_DELAY_NUM	2	3	0	2	3	0

1. mode0 means CPOL=0, CPHA=0. When SPI is idle, the clock output is logic low; data changes on the falling edge of the SPI clock and is sampled on the rising edge;
2. mode1 means CPOL=0, CPHA=1. When SPI is idle, the clock output is logic low; data changes on the rising edge of the SPI clock and is sampled on the falling edge;

3. mode2 means when CPOL=1, CPHA=0. When SPI is idle, the clock output is logic high; data changes on the rising edge of the SPI clock and is sampled on the falling edge;
4. mode3 means when CPOL=1, CPHA=1. When SPI is idle, the clock output is logic high; data changes on the falling edge of the SPI clock and is sampled on the rising edge.

### 7.4.2 GP-SPI Timing

The data signals of ESP32 GP-SPI can be mapped to physical pins either via IO\_MUX or via IO\_MUX and GPIO matrix. Input signals will be delayed by two  $clk_{apb}$  clock cycles when they pass through the matrix. Output signals will not be delayed.

When GP-SPI is used as master and the data signals are not received by the SPI controller via GPIO matrix, if GP-SPI output clock frequency is  $clk_{apb}/2$ , register SPI\_MISO\_DELAY\_MODE should be set to 0 when configuring the clock polarity. If GP-SPI output clock frequency is not higher than  $clk_{apb}/4$ , register SPI\_MISO\_DELAY\_MODE can be set to the corresponding value in Table 7-3 when configuring the clock polarity.

When GP-SPI is used in master mode and the data signals enter the SPI controller via the GPIO matrix:

1. If GP-SPI output clock frequency is  $clk_{apb}/2$ , register SPI\_MISO\_DELAY\_MODE should be set to 0 and the dummy phase should be enabled (SPI\_USR\_DUMMY = 1) for one  $clk_{spi}$  clock cycle (SPI\_USR\_DUMMY\_CYC\_LEN = 0) when configuring the clock polarity;
2. If GP-SPI output clock frequency is  $clk_{apb}/4$ , register SPI\_MISO\_DELAY\_MODE should be set to 0 when configuring the clock polarity;
3. If GP-SPI output clock frequency is not higher than  $clk_{apb}/8$ , register SPI\_MISO\_DELAY\_MODE can be set to the corresponding value in Table 7-3 when configuring the clock polarity.

When GP-SPI is used in slave mode, the clock signal and the data signals should be routed to the SPI controller via the same path, i.e., neither the clock signal nor the data signals passes through GPIO matrix, or both of them pass through GPIO matrix. This is important in ensuring that the signals are not delayed by different time periods before they reach the SPI hardware.

Assume that  $t_{spi}$ ,  $t_{pre}$  and  $t_v$  in Figure 7-4 denote SPI clock period, how far ahead data output is, and data output delay time, respectively. Assume the SPI slave's main clock period is  $t_{apb}$ . For non-DMA mode0, SPI slave data output is delayed by  $t_v$ :

- $t_v < 3.5 * t_{apb}$ , if CLK does not pass through GPIO matrix;
- $t_v < 5.5 * t_{apb}$ , if CLK passes through GPIO matrix.

In DMA mode1 and mode3, SPI slave data output is delayed by the same period of time as in non-DMA mode. However, for mode0 and mode2, SPI slave data is output earlier by  $t_{pre}$ :

- $t_{pre} < (t_{spi}/2 - 5.5 * t_{apb})$ , if CLK does not pass through GPIO matrix;
- $t_{pre} < (t_{spi}/2 - 7.5 * t_{apb})$ , if CLK passes through GPIO matrix.

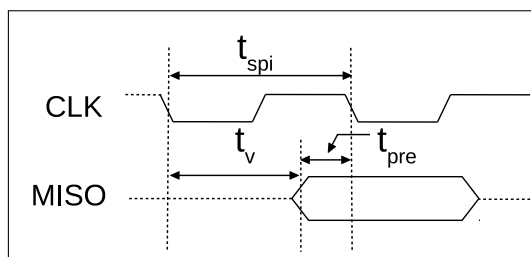


Figure 7-4. GP-SPI

To conclude, if signals do not pass through GPIO matrix, the SPI slave clock frequency is up to  $f_{apb}/8$ ; if signals pass through GPIO matrix, the SPI slave clock frequency is up to  $f_{apb}/12$ . Note that  $(t_{spi}/2 - t_{pre})$  represents data output hold time for SPI slave in mode0 and mode2.

## 7.5 Parallel QSPI

ESP32 SPI controllers support SPI bus memory devices (such as flash and SRAM). The hardware connection between the SPI pins and the memories is shown by Figure 7-5.

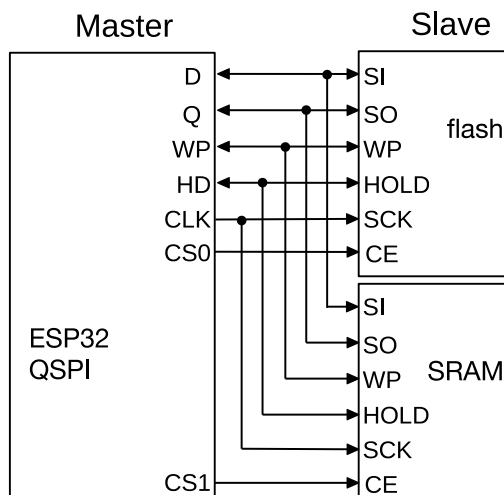


Figure 7-5. Parallel QSPI

SPI1, SPI2 and SPI3 controllers can also be configured as QSPI master to connect to external memory. The maximum output clock frequency of the SPI memory interface is  $f_{apb}$ , with the same clock configuration as that of the GP-SPI master.

### 7.5.1 Communication Format of Parallel QSPI

To support communication with special slave devices, ESP32 QSPI implements a specifically designed communication protocol. The communication format of ESP32 QSPI master is the same as that of GP-SPI four-line half-duplex communication, except that in address phase and data phase, software can configure registers to enable two-line or four-line transmission. Figure 7-6 shows a QSPI communication mode with four-line transmission in address phase and data phase.

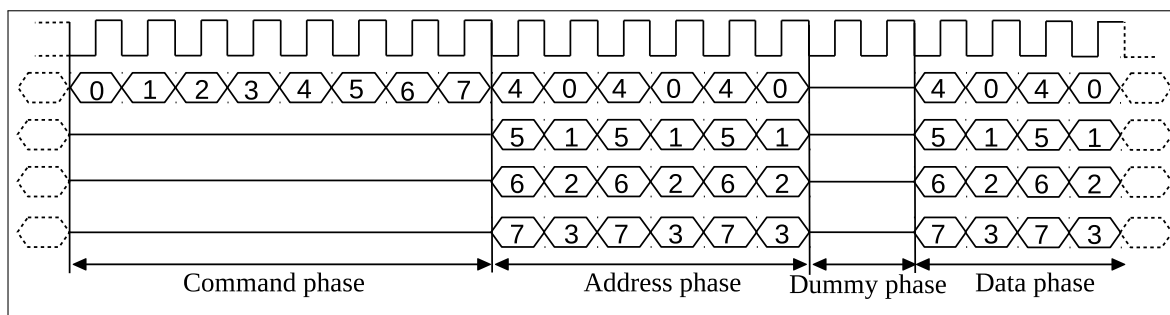


Figure 7-6. Communication Format of Parallel QSPI

ESP32 QSPI supports flash-read operation in one-line, two-line, and four-line modes. When working as a QSPI master, the command phase, address phase, dummy phase and data phase can be configured as needed, as flexible as in GP-SPI mode.

**Note** that GPI-SPI full-duplex mode does not support dummy phase.

## 7.6 GP-SPI Interrupt Hardware

ESP32 SPI generates two types of interrupts. One is the SPI interrupt and the other is the SPI DMA interrupt.

ESP32 SPI reckons the completion of send- and/or receive-operations as the completion of one operation from the controller and generates one interrupt. When ESP32 SPI is configured to slave mode, the slave will generate read/write status registers and read/write buffer data interrupts according to different operations.

### 7.6.1 SPI Interrupts

The SPI\*\_INTEN bits in the SPI\_SLAVE\_REG register can be set to enable SPI interrupts. When an SPI interrupt happens, the interrupt flag in the corresponding SPI\*\_DONE register will get set. This flag is writable, and an interrupt can be cleared by setting the bit to zero.

- SPI\_TRANS\_DONE\_INT: Triggered when an SPI operation is done.
- SPI\_SLV\_WR\_STA\_INT: Triggered when an SPI slave status write is done.
- SPI\_SLV\_RD\_STA\_INT: Triggered when an SPI slave status read is done.
- SPI\_SLV\_WR\_BUF\_INT: Triggered when an SPI slave buffer write is done.
- SPI\_SLV\_RD\_BUD\_INT: Triggered when an SPI slave buffer read is done.

### 7.6.2 DMA Interrupts

- SPI\_OUT\_TOTAL\_EOF\_INT: Triggered when all linked lists are sent.
- SPI\_OUT\_EOF\_INT: Triggered when one linked list is sent.
- SPI\_OUT\_DONE\_INT: Triggered when the last linked list item has zero length.
- SPI\_IN\_SUC\_EOF\_INT: Triggered when all linked lists are received.
- SPI\_IN\_ERR\_EOF\_INT: Triggered when there is an error receiving linked lists.
- SPI\_IN\_DONE\_INT: Triggered when the last received linked list had a length of 0.
- SPI\_INLINK\_DSCR\_ERROR\_INT: Triggered when the received linked list is invalid.
- SPI\_OUTLINK\_DSCR\_ERROR\_INT: Triggered when the linked list to be sent is invalid.

- SPI\_INLINK\_DSCR\_EMPTY\_INT: Triggered when no valid linked list is available.

## 7.7 Register Summary

Name	Description	SPI0	SPI1	SPI2	SPI3	Acc
<b>Control and configuration registers</b>						
SPI_CTRL_REG	Bit order and QIO/DIO/QOUT/DOOUT mode settings	3FF43008	3FF42008	3FF64008	3FF65008	R/W
SPI_CTRL2_REG	Timing configuration	3FF43014	3FF42014	3FF64014	3FF65014	R/W
SPI_CLOCK_REG	Clock configuration	3FF43018	3FF42018	3FF64018	3FF65018	R/W
SPI_PIN_REG	Polarity and CS configuration	3FF43034	3FF42034	3FF64034	3FF65034	R/W
<b>Slave mode configuration registers</b>						
SPI_SLAVE_REG	Slave mode configuration and interrupt status	3FF43038	3FF42038	3FF64038	3FF65038	R/W
SPI_SLAVE1_REG	Slave data bit lengths	3FF4303C	3FF4203C	3FF6403C	3FF6503C	R/W
SPI_SLAVE2_REG	Dummy cycle length configuration	3FF43040	3FF42040	3FF64040	3FF65040	R/W
SPI_SLV_WR_STATUS_REG	Slave status/Part of lower master address	3FF43030	3FF42030	3FF64030	3FF65030	R/W
SPI_SLV_WRBUF_DLEN_REG	Write-buffer operation length	3FF43048	3FF42048	3FF64048	3FF65048	R/W
SPI_SLV_RDBUF_DLEN_REG	Read-buffer operation length	3FF4304C	3FF4204C	3FF6404C	3FF6504C	R/W
SPI_SLV_RD_BIT_REG	Read data operation length	3FF43064	3FF42064	3FF64064	3FF65064	R/W
<b>User-defined command mode registers</b>						
SPI_CMD_REG	Start user-defined command	3FF43000	3FF42000	3FF64000	3FF65000	R/W
SPI_ADDR_REG	Address data	3FF43004	3FF42004	3FF64004	3FF65004	R/W
SPI_USER_REG	User defined command configuration	3FF4301C	3FF4201C	3FF6401C	3FF6501C	R/W
SPI_USER1_REG	Address and dummy cycle configuration	3FF43020	3FF42020	3FF64020	3FF65020	R/W
SPI_USER2_REG	Command length and value configuration	3FF43024	3FF42024	3FF64024	3FF65024	R/W
SPI_MOSI_DLEN_REG	MOSI length	3FF43028	3FF42028	3FF64028	3FF65028	R/W
SPI_W0_REG	SPI data register 0	3FF43080	3FF42080	3FF64080	3FF65080	R/W
SPI_W1_REG	SPI data register 1	3FF43084	3FF42084	3FF64084	3FF65084	R/W
SPI_W2_REG	SPI data register 2	3FF43088	3FF42088	3FF64088	3FF65088	R/W
SPI_W3_REG	SPI data register 3	3FF4308C	3FF4208C	3FF6408C	3FF6508C	R/W
SPI_W4_REG	SPI data register 4	3FF43090	3FF42090	3FF64090	3FF65090	R/W

Name	Description	SPI0	SPI1	SPI2	SPI3	Acc
SPI_W5_REG	SPI data register 5	3FF43094	3FF42094	3FF64094	3FF65094	R/W
SPI_W6_REG	SPI data register 6	3FF43098	3FF42098	3FF64098	3FF65098	R/W
SPI_W7_REG	SPI data register 7	3FF4309C	3FF4209C	3FF6409C	3FF6509C	R/W
SPI_W8_REG	SPI data register 8	3FF430A0	3FF420A0	3FF640A0	3FF650A0	R/W
SPI_W9_REG	SPI data register 9	3FF430A4	3FF420A4	3FF640A4	3FF650A4	R/W
SPI_W10_REG	SPI data register 10	3FF430A8	3FF420A8	3FF640A8	3FF650A8	R/W
SPI_W11_REG	SPI data register 11	3FF430AC	3FF420AC	3FF640AC	3FF650AC	R/W
SPI_W12_REG	SPI data register 12	3FF430B0	3FF420B0	3FF640B0	3FF650B0	R/W
SPI_W13_REG	SPI data register 13	3FF430B4	3FF420B4	3FF640B4	3FF650B4	R/W
SPI_W14_REG	SPI data register 14	3FF430B8	3FF420B8	3FF640B8	3FF650B8	R/W
SPI_W15_REG	SPI data register 15	3FF430BC	3FF420BC	3FF640BC	3FF650BC	R/W
<b>DMA configuration registers</b>						
SPI_DMA_CONF_REG	DMA configuration register	3FF43100	3FF42100	3FF64100	3FF65100	R/W
SPI_DMA_OUT_LINK_REG	DMA outlink address and configuration	3FF43104	3FF42104	3FF64104	3FF65104	R/W
SPI_DMA_IN_LINK_REG	DMA inlink address and configuration	3FF43108	3FF42108	3FF64108	3FF65108	R/W
SPI_DMA_STATUS_REG	DMA status	3FF4310C	3FF4210C	3FF6410C	3FF6510C	RO
SPI_IN_ERR_EOF_DES_ADDR_REG	Descriptor address where an error occurs	3FF43120	3FF42120	3FF64120	3FF65120	RO
SPI_IN_SUC_EOF_DES_ADDR_REG	Descriptor address where EOF occurs	3FF43124	3FF42124	3FF64124	3FF65124	RO
SPI_INLINK_DSCR_REG	Current descriptor pointer	3FF43128	3FF42128	3FF64128	3FF65128	RO
SPI_INLINK_DSCR_BF0_REG	Next descriptor data pointer	3FF4312C	3FF4212C	3FF6412C	3FF6512C	RO
SPI_INLINK_DSCR_BF1_REG	Current descriptor data pointer	3FF43130	3FF42130	3FF64130	3FF65130	RO
SPI_OUT_EOF_BFR_DES_ADDR_REG	Relative buffer address where EOF occurs	3FF43134	3FF42134	3FF64134	3FF65134	RO
SPI_OUT_EOF_DES_ADDR_REG	Descriptor address where EOF occurs	3FF43138	3FF42138	3FF64138	3FF65138	RO
SPI_OUTLINK_DSCR_REG	Current descriptor pointer	3FF4313C	3FF4213C	3FF6413C	3FF6513C	RO
SPI_OUTLINK_DSCR_BF0_REG	Next descriptor data pointer	3FF43140	3FF42140	3FF64140	3FF65140	RO
SPI_OUTLINK_DSCR_BF1_REG	Current descriptor data pointer	3FF43144	3FF42144	3FF64144	3FF65144	RO
SPI_DMA_RSTATUS_REG	DMA memory read status	3FF43148	3FF42148	3FF64148	3FF65148	RO

Name	Description	SPI0	SPI1	SPI2	SPI3	Acc
<a href="#">SPI_DMA_TSTATUS_REG</a>	DMA memory write status	3FF4314C	3FF4214C	3FF6414C	3FF6514C	RO
<b>DMA interrupt registers</b>						
<a href="#">SPI_DMA_INT_RAW_REG</a>	Raw interrupt status	3FF43114	3FF42114	3FF64114	3FF65114	RO
<a href="#">SPI_DMA_INT_ST_REG</a>	Masked interrupt status	3FF43118	3FF42118	3FF64118	3FF65118	RO
<a href="#">SPI_DMA_INT_ENA_REG</a>	Interrupt enable bits	3FF43110	3FF42110	3FF64110	3FF65110	R/W
<a href="#">SPI_DMA_INT_CLR_REG</a>	Interrupt clear bits	3FF4311C	3FF4211C	3FF6411C	3FF6511C	R/W

## 7.8 Registers

The addresses in parenthesis besides register names are the register addresses relative to the SPI0/SPI1/SPI2/SPI3 base addresses provided in Table 1-6 *Peripheral Address Mapping* in Chapter 1 *System and Memory*. The absolute register addresses are listed in Section 7.7 *Register Summary*.

Register 7.1. SPI\_CMD\_REG (0x0)

(reserved)													19	18	17	(reserved)														Reset															
31													0	0	0	0	0	0	0	0	0	0	0	0	0	0	0	0	0		0	0	0	0	0	0	0	0	0	0	0	0	0	0	0

**SPI\_USR** An SPI operation will be triggered when this bit is set. The bit will be cleared once the operation is done. (R/W)

Register 7.2. SPI\_ADDR\_REG (0x4)

31																															0	Reset
0x00000000																															0	

**SPI\_ADDR\_REG** It stores the transmitting address when master is in half-duplex mode or QSPI mode. If the address length is bigger than 32 bits, this register stores the higher 32 bits of address value, [SPI\\_SLV\\_WR\\_STATUS\\_REG](#) stores the rest lower part of address value. If the address length is smaller than 33 bits, this register stores all the address value. The register is in valid only when [SPI\\_USR\\_ADDR](#) bit is set to 1. (R/W)



**Register 7.3. SPI\_CTRL\_REG (0x8)**

(reserved)	SPI_WR_BIT_ORDER	SPI_RD_BIT_ORDER	SPI_FREAD_QIO	SPI_FREAD_DIO	SPI_WP	SPI_FREAD_QUAD	(reserved)	SPI_FREAD_DUAL	SPI_FASTRD_MODE	(reserved)				
31	27	26	25	24	23	22	21	20	19	15	14	13	12	0
0	0	0	0	0	0	1	0	0	0	0	0	0	1	0

Reset

**SPI\_WR\_BIT\_ORDER** This bit determines the bit order for command, address and data in transmitted signal. 1: sends LSB first; 0: sends MSB first. (R/W)

**SPI\_RD\_BIT\_ORDER** This bit determines the bit order for received data in received signal. 1: receives LSB first; 0: receives MSB first. (R/W)

**SPI\_FREAD\_QIO** This bit is used to enable four-line address writes and data reads in QSPI mode. (R/W)

**SPI\_FREAD\_DIO** This bit is used to enable two-line address writes and data reads in QSPI mode. (R/W)

**SPI\_WP** This bit determines the write-protection signal output when SPI is idle in QSPI mode. 1: output high; 0: output low. (R/W)

**SPI\_FREAD\_QUAD** This bit is used to enable four-line data reads in QSPI mode. (R/W)

**SPI\_FREAD\_DUAL** This bit is used to enable two-line data reads in QSPI mode. (R/W)

**SPI\_FASTRD\_MODE** Reserved.

**Register 7.4. SPI\_CTRL1\_REG (0xC)**

SPI_CS_HOLD_DELAY	(reserved)		
31	28	27	0
0x05	0	0	0

Reset

**SPI\_CS\_HOLD\_DELAY** Reserved.

## Register 7.5. SPI\_RD\_STATUS\_REG (0x10)

<i>SPI_STATUS_EXT</i>		<i>SPI_STATUS</i>													
31	24	23	16	15											0
0x000		0x000			0 0 0 0 0 0 0 0 0 0 0 0 0 0 0 0										Reset

**SPI\_STATUS\_EXT** Reserved.

**SPI\_STATUS** Reserved.

**Register 7.6. SPI\_CTRL2\_REG (0x14)**

SPI_CS_DELAY_NUM		SPI_CS_DELAY_MODE		SPI_MOSI_DELAY_NUM		SPI_MOSI_DELAY_MODE		SPI_MISO_DELAY_NUM		SPI_MISO_DELAY_MODE		SPI_CK_OUT_HIGH_MODE		reserved		SPI_HOLD_TIME		SPI_SETUP_TIME	
31	28	27	26	25	23	22	21	20	18	17	16	15	12	11	8	7	4	3	0
0x00		0x0		0x0		0x0		0x0		0x0		0x00		0x00		0x01		0x01	
Reset																			

**SPI\_CS\_DELAY\_NUM** Reserved.

**SPI\_CS\_DELAY\_MODE** Reserved.

**SPI\_MOSI\_DELAY\_NUM** It is used to configure the number of system clock cycles by which the MOSI signals are delayed. (R/W)

**SPI\_MOSI\_DELAY\_MODE** This register field determines the way the MOSI signals are delayed by SPI clock. (R/W)

After being delayed by SPI\_MOSI\_DELAY\_NUM system clocks, the MOSI signals will then be delayed by the configuration of SPI\_MOSI\_DELAY\_MODE, specifically:

0: no delay.

1: if SPI\_CK\_OUT\_EDGE or SPI\_CK\_I\_EDGE is set, the MOSI signals are delayed by half a cycle, otherwise they are delayed by one cycle.

2: if SPI\_CK\_OUT\_EDGE or SPI\_CK\_I\_EDGE is set, the MOSI signals are delayed by one cycle, otherwise they are delayed by half a cycle.

3: the MOSI signals are delayed one cycle.

**SPI\_MISO\_DELAY\_NUM** It is used to configure the number of system clock cycles by which the MISO signals are delayed. (R/W)

**SPI\_MISO\_DELAY\_MODE** This register field determines the way MISO signals are delayed by SPI clock. (R/W)

After being delayed by SPI\_MISO\_DELAY\_NUM system clock, the MISO signals will then be delayed by the configuration of SPI\_MISO\_DELAY\_MODE, specifically:

0: no delay.

1: if SPI\_CK\_OUT\_EDGE or SPI\_CK\_I\_EDGE is set, the MISO signals are delayed by half a cycle, otherwise they are delayed by one cycle.

2: if SPI\_CK\_OUT\_EDGE or SPI\_CK\_I\_EDGE is set, the MISO signals are delayed by one cycle, otherwise they are delayed by half a cycle.

3: the MISO signals are delayed by one cycle.

**SPI\_HOLD\_TIME** The number of SPI clock cycles by which CS pin signals are delayed. It is only valid when SPI\_CS\_HOLD is set to 1. (R/W)

**SPI\_SETUP\_TIME** It is to configure the time between the CS signal active edge and the first SPI clock edge. It is only valid in half-duplex mode or QSPI mode and when SPI\_CS\_SETUP is set to 1. (R/W)

## Register 7.7. SPI\_CLOCK\_REG (0x18)

SPI_CLK_EQU_SYSCLK		SPI_CLKDIV_PRE						SPI_CLKCNT_N				SPI_CLKCNT_H		SPI_CLKCNT_L					
31	30							18	17			12	11			6	5	0	
1	0 0 0 0 0 0 0 0 0 0 0 0 0 0 0 0						0x03				0x01		0x03		Reset				

**SPI\_CLK\_EQU\_SYSCLK** In master mode, when this bit is set to 1, SPI output clock is equal to system clock; when set to 0, SPI output clock is divided from system clock. In slave mode, it should be set to 0. (R/W)

**SPI\_CLKDIV\_PRE** In master mode, it is used to configure the pre-divider value for SPI output clock. It is only valid when SPI\_CLK\_EQU\_SYSCLK is 0. In slave mode, it should be set to 0. (R/W)

**SPI\_CLKCNT\_N** In master mode, it is used to configure the divider for SPI output clock. It is only valid when SPI\_CLK\_EQU\_SYSCLK is 0. In slave mode, it should be set to 0. (R/W)

**SPI\_CLKCNT\_H** In master mode,  $SPI\_CLKCNT\_H = \lfloor \frac{SPI\_CLKCNT\_N+1}{2} - 1 \rfloor$ . It is only valid when SPI\_CLK\_EQU\_SYSCLK is 0. In slave mode, it should be set to 0. (R/W)

**SPI\_CLKCNT\_L** In master mode, it is equal to SPI\_CLKCNT\_N. It is only valid when SPI\_CLK\_EQU\_SYSCLK is 0. In slave mode, it should be set to 0. (R/W)

Register 7.8. SPI\_USER\_REG (0x1C)

31	30	29	28	27	26	25	24	23	(reserved)								17	16	15	14	13	12	11	10	9	8	7	6	5	4	3	(reserved)			1	0
1	0	0	0	0	0	0	0	0	0	0	0	0	0	0	0	0	0	0	0	0	0	0	0	0	1	0	0	0	0	0	0	0	0	0	0	Reset

**SPI\_USR\_COMMAND** This bit enables the command phase of an SPI operation in SPI half-duplex mode and QSPI mode. (R/W)

**SPI\_USR\_ADDR** This bit enables the address phase of an SPI operation in SPI half-duplex mode and QSPI mode. (R/W)

**SPI\_USR\_DUMMY** This bit enables the dummy phase of an SPI operation in SPI half-duplex mode and QSPI mode. (R/W)

**SPI\_USR\_MISO** This bit enables the read-data phase of an SPI operation in SPI half-duplex mode and QSPI mode. (R/W)

**SPI\_USR\_MOSI** This bit enables the write-data phase of an SPI operation in SPI half-duplex mode and QSPI mode. (R/W)

**SPI\_USR\_DUMMY\_IDLE** The SPI clock signal is disabled in the dummy phase when the bit is set in SPI half-duplex mode and QSPI mode. (R/W)

**SPI\_USR\_MOSI\_HIGHPART** If set, MOSI data is stored in SPI\_W8 ~ SPI\_W15 of the SPI buffer. (R/W)

**SPI\_USR\_MISO\_HIGHPART** If set, MISO data is stored in SPI\_W8 ~ SPI\_W15 of the SPI buffer. (R/W)

**SPI\_SIO** Set this bit to enable three-line half-duplex communication. (R/W)

**SPI\_FWRITE\_QIO** Reserved.

**SPI\_FWRITE\_DIO** Reserved.

**SPI\_FWRITE\_QUAD** Reserved.

**SPI\_FWRITE\_DUAL** Reserved.

**SPI\_WR\_BYTE\_ORDER** This bit determines the byte order of the command, address and data in transmitted signal. 1: big-endian; 0: little-endian. (R/W)

**SPI\_RD\_BYTE\_ORDER** This bit determines the byte order of received data in transmitted signal. 1: big-endian; 0: little-endian. (R/W)

**SPI\_CK\_OUT\_EDGE** This bit, combined with SPI\_MOSI\_DELAY\_MODE, sets the MOSI signal delay mode. It is only valid in master mode. (R/W)

**SPI\_CK\_I\_EDGE** In slave mode, the bit is the same as SPI\_CK\_OUT\_EDGE in master mode. It is combined with SPI\_MISO\_DELAY\_MODE. It is only valid in slave mode. (R/W)

Continued on the next page...

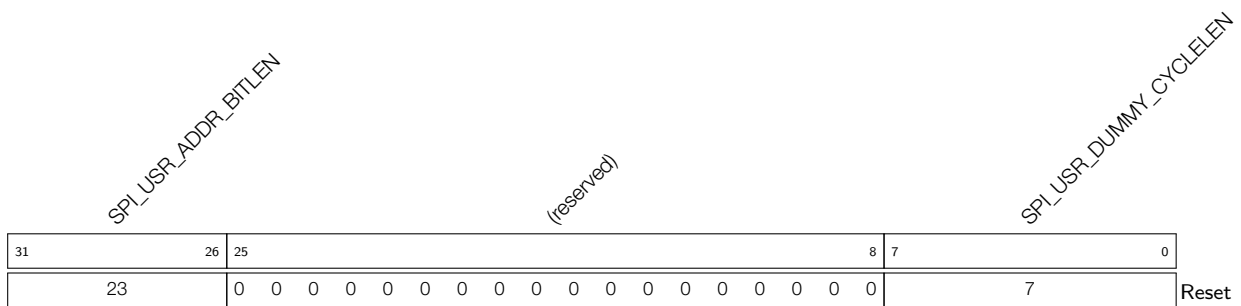
**Register 7.8. SPI\_USER\_REG (0x1C)**

Continued from the previous page...

**SPI\_CS\_SETUP** Setting this bit enables a delay between CS active edge and the first clock edge, in multiples of one SPI clock cycle. In full-duplex mode and QSPI mode, setting this bit results in  $(\text{SPI\_SETUP\_TIME} + 1.5)$  SPI clock cycles delay. In full-duplex mode, there will be 1.5 SPI clock cycles delay for mode0 and mode2, and 1 SPI clock cycle delay for mode1 and mode3. (R/W)

**SPI\_CS\_HOLD** Setting this bit enables a delay between the end of a transmission and CS being inactive, as specified in SPI\_HOLD\_TIME. (R/W)

**SPI\_DOUTDIN** Set the bit to enable full-duplex communication. (R/W)

**Register 7.9. SPI\_USER1\_REG (0x20)**

**SPI\_USR\_ADDR\_BITLEN** It indicates the bit length of the transmitted address minus one in half-duplex mode and QSPI mode, in multiples of one bit. It is only valid when SPI\_USR\_ADDR is set to 1. (RO)

**SPI\_USR\_DUMMY\_CYCLELEN** It indicates the number of SPI clock cycles for the dummy phase minus one in SPI half-duplex mode and QSPI mode. It is only valid when SPI\_USR\_DUMMY is set to 1. (R/W)

**Register 7.10. SPI\_USER2\_REG (0x24)**

<i>SPI_USR_COMMAND_BITLEN</i>							<i>(reserved)</i>										<i>SPI_USR_COMMAND_VALUE</i>				
31	28	27											16	15						0	
7							0 0										Reset				

**SPI\_USR\_COMMAND\_BITLEN** It indicates the bit length of the command phase minus one in SPI half-duplex mode and QSPI mode. It is only valid when SPI\_USR\_COMMAND is set to 1. (R/W)

**SPI\_USR\_COMMAND\_VALUE** It indicates the value of the command to be transmitted in SPI half-duplex mode and QSPI mode. It is only valid when SPI\_USR\_COMMAND is set to 1. (R/W)

**Register 7.11. SPI\_MOSI\_DLEN\_REG (0x28)**

<i>(reserved)</i>								<i>SPI_USR_MOSI_DBITLEN</i>																	
31								24	23																0
0 0 0 0 0 0 0 0								0x0000000																Reset	

**SPI\_USR\_MOSI\_DBITLEN** It indicates the length of MOSI data minus one, in multiples of one bit. It is only valid when SPI\_USR\_MOSI is set to 1 in master mode. (R/W)

**Register 7.12. SPI\_MISO\_DLEN\_REG (0x2C)**

<i>(reserved)</i>								<i>SPI_USR_MISO_DBITLEN</i>																	
31								24	23																0
0 0 0 0 0 0 0 0								0x0000000																Reset	

**SPI\_USR\_MISO\_DBITLEN** It indicates the length of MISO data minus one, in multiples of one bit. It is only valid when SPI\_USR\_MISO is set to 1 in master mode. (R/W)

## Register 7.13. SPI\_SLV\_WR\_STATUS\_REG (0x30)

31																													0	
0																														Reset

**SPI\_SLV\_WR\_STATUS\_REG** In the slave mode this register is the status register for the master to write the slave. In the master mode, if the address length is bigger than 32 bits, **SPI\_ADDR\_REG** stores the higher 32 bits of address value, and this register stores the rest lower part of address value. (R/W)

## Register 7.14. SPI\_PIN\_REG (0x34)

31	30	29	28							14	13				11	10	9	8				6	5	4	3	2	1	0
0	0	0	0	0	0	0	0	0	0	0	0	0	0	0	0	0	0	0	0	0	0	0	0	0	1	1	0	Reset

(reserved) SPI\_CS\_KEEP\_ACTIVE SPI\_CS\_IDLE\_EDGE (reserved) SPI\_MASTER\_CK\_SEL (reserved) SPI\_MASTER\_CS\_POL SPI\_CK\_DIS (reserved) SPI\_CS2\_DIS SPI\_CS1\_DIS SPI\_CS0\_DIS

**SPI\_CS\_KEEP\_ACTIVE** This bit is only used in master mode where when it is set, the CS signal will keep active. (R/W)

**SPI\_CK\_IDLE\_EDGE** This bit is only used in master mode to configure the logic level of SPI output clock in idle state. (R/W)

- 1: the spi\_clk line keeps high when idle;
- 0: the spi\_clk line keeps low when idle.

**SPI\_MASTER\_CK\_SEL** Reserved.

**SPI\_MASTER\_CS\_POL** Reserved.

**SPI\_CK\_DIS** Reserved.

**SPI\_CS2\_DIS** This bit enables the SPI CS2 signal. 1: disables CS2; 0: enables CS2. (R/W)

**SPI\_CS1\_DIS** This bit enables the SPI CS1 signal. 1: disables CS1; 0: enables CS1. (R/W)

**SPI\_CS0\_DIS** This bit enables the SPI CS0 signal. 1: disables CS0; 0: enables CS0. (R/W)



Register 7.15. SPI\_SLAVE\_REG (0x38)

SPI_SYNC_RESET		SPI_SLAVE_MODE		SPI_SLV_WR_RD_BUF_EN		SPI_SLV_WR_RD_STA_EN		SPI_SLV_CMD_DEFINE		SPI_TRANS_CNT		SPI_SLV_LAST_STATE		SPI_SLV_LAST_COMMAND		(reserved)		SPI_CS_I_MODE		SPI_TRANS_INTEN		SPI_SLV_WR_STA_INTEN		SPI_SLV_RD_STA_INTEN		SPI_SLV_WR_BUF_INTEN		SPI_TRANS_DONE		SPI_SLV_WR_STA_DONE		SPI_SLV_RD_STA_DONE		SPI_SLV_WR_BUF_DONE		SPI_SLV_RD_BUF_DONE	
31	30	29	28	27	26	25	24	23	22	21	20	19	18	17	16	15	14	13	12	11	10	9	8	7	6	5	4	3	2	1	0						
0	0	0	0	0	0	0	0	0	0	0	0	0	0	0	0	0	0	0	0	0	0	0	0	0	0	0	0	0	0	0	0	0	0	0	0	0	0

Reset

**SPI\_SYNC\_RESET** When set, it resets the latched values of the SPI clock line, CS line and data line.

(R/W)

**SPI\_SLAVE\_MODE** This bit is used to set the mode of the SPI device. (R/W)

1: slave mode;

0: master mode.

**SPI\_SLV\_WR\_RD\_BUF\_EN** This bit is only used in slave half-duplex mode, where when it is set, the write and read data commands are enabled. (R/W)

**SPI\_SLV\_WR\_RD\_STA\_EN** This bit is only used in slave half-duplex mode, where when it is set, the write and read status commands are enabled. (R/W)

**SPI\_SLV\_CMD\_DEFINE** Reserved.

**SPI\_TRANS\_CNT** The counter for operations in both the master mode and the slave mode. (RO)

**SPI\_SLV\_LAST\_STATE** In slave mode, this contains the state of the SPI state machine. (RO)

**SPI\_SLV\_LAST\_COMMAND** Reserved.

**SPI\_CS\_I\_MODE** Reserved.

**SPI\_TRANS\_INTEN** The interrupt enable bit for the [SPI\\_TRANS\\_DONE\\_INT](#) interrupt. (R/W)

**SPI\_SLV\_WR\_STA\_INTEN** The interrupt enable bit for the [SPI\\_SLV\\_WR\\_STA\\_INT](#) interrupt. (R/W)

**SPI\_SLV\_RD\_STA\_INTEN** The interrupt enable bit for the [SPI\\_SLV\\_RD\\_STA\\_INT](#) interrupt. (R/W)

**SPI\_SLV\_WR\_BUF\_INTEN** The interrupt enable bit for the [SPI\\_SLV\\_WR\\_BUF\\_INT](#) interrupt. (R/W)

**SPI\_SLV\_RD\_BUF\_INTEN** The interrupt enable bit for the [SPI\\_SLV\\_RD\\_BUF\\_INT](#) interrupt. (R/W)

**SPI\_TRANS\_DONE** The raw interrupt status bit for the [SPI\\_TRANS\\_DONE\\_INT](#) interrupt. It is set by hardware and cleared by software. (R/W)

**SPI\_SLV\_WR\_STA\_DONE** The raw interrupt status bit for the [SPI\\_SLV\\_WR\\_STA\\_INT](#) interrupt. It is set by hardware and cleared by software, and only applicable to slave half-duplex mode. (R/W)

**SPI\_SLV\_RD\_STA\_DONE** The raw interrupt status bit for the [SPI\\_SLV\\_RD\\_STA\\_INT](#) interrupt. It is set by hardware and cleared by software, and only applicable to slave half-duplex mode. (R/W)

Continued on the next page...

## Register 7.15. SPI\_SLAVE\_REG (0x38)

Continued from the previous page ...

**SPI\_SLV\_WR\_BUF\_DONE** The raw interrupt status bit for the [SPI\\_SLV\\_WR\\_BUF\\_INT](#) interrupt. It is set by hardware and cleared by software, and only applicable to slave half-duplex mode. (R/W)

**SPI\_SLV\_RD\_BUF\_DONE** The raw interrupt status bit for the [SPI\\_SLV\\_RD\\_BUF\\_INT](#) interrupt. It is set by hardware and cleared by software, and only applicable to slave half-duplex mode. (R/W)

## Register 7.16. SPI\_SLAVE1\_REG (0x3C)

31	27	26	25	24	16	15	10	9	4	3	2	1	0	Reset					
SPI_SLV_STATUS_BITLEN			SPI_SLV_STATUS_FAST_EN		(reserved)		SPI_SLV_RD_ADDR_BITLEN		SPI_SLV_WR_ADDR_BITLEN		SPI_SLV_WRSTA_DUMMY_EN		SPI_SLV_RDSTA_DUMMY_EN		SPI_SLV_WRBUF_DUMMY_EN		SPI_SLV_RDBUF_DUMMY_EN		
0	0	0	0	0	0	1	0	0	0	0	0	0	0	0	0	0	0	0	0

**SPI\_SLV\_STATUS\_BITLEN** It is only used in slave half-duplex mode to configure the length of the master writing into the status register. (R/W)

**SPI\_SLV\_STATUS\_FAST\_EN** Reserved.

**SPI\_SLV\_STATUS\_READBACK** Reserved.

**SPI\_SLV\_RD\_ADDR\_BITLEN** It indicates the address length in bits minus one for a slave-read operation. It is only valid in slave half-duplex mode. (R/W)

**SPI\_SLV\_WR\_ADDR\_BITLEN** It indicates the address length in bits minus one for a slave-write operation. It is only valid in slave half-duplex mode. (R/W)

**SPI\_SLV\_WRSTA\_DUMMY\_EN** In slave mode, this bit enables the dummy phase for write-status operations. It is only valid in slave half-duplex mode.(R/W)

**SPI\_SLV\_RDSTA\_DUMMY\_EN** In slave mode, this bit enables the dummy phase for read-status operations. It is only valid in slave half-duplex mode. (R/W)

**SPI\_SLV\_WRBUF\_DUMMY\_EN** In slave mode, this bit enables the dummy phase for write-buffer operations. It is only valid in slave half-duplex mode. (R/W)

**SPI\_SLV\_RDBUF\_DUMMY\_EN** In slave mode, this bit enables the dummy phase for read-buffer operations. It is only valid in slave half-duplex mode. (R/W)

**Register 7.17. SPI\_SLAVE2\_REG (0x40)**

<i>SPI_SLV_WRBUF_DUMMY_CYCLELEN</i>								<i>SPI_SLV_RDBUF_DUMMY_CYCLELEN</i>								<i>SPI_SLV_WRSTA_DUMMY_CYCLELEN</i>								<i>SPI_SLV_RDSTA_DUMMY_CYCLELEN</i>								
31								24	23							16	15			8	7							0				
0 0 0 0 0 0 0 0								0x000								0x000								0x000								Reset

**SPI\_SLV\_WRBUF\_DUMMY\_CYCLELEN** It indicates the number of SPI clock cycles minus one for the dummy phase for write-data operations. It is only valid when SPI\_SLV\_WRBUF\_DUMMY\_EN is set to 1 in slave half-duplex mode. (R/W)

**SPI\_SLV\_RDBUF\_DUMMY\_CYCLELEN** It indicates the number of SPI clock cycles minus one for the dummy phase for read-data operations. It is only valid when SPI\_SLV\_RDBUF\_DUMMY\_EN is set to 1 in slave half-duplex mode. (R/W)

**SPI\_SLV\_WRSTA\_DUMMY\_CYCLELEN** It indicates the number of SPI clock cycles minus one for the dummy phase for write-status register operations. It is only valid when SPI\_SLV\_WRSTA\_DUMMY\_EN is set to 1 in slave half-duplex mode. (R/W)

**SPI\_SLV\_RDSTA\_DUMMY\_CYCLELEN** It indicates the number of SPI clock cycles minus one for the dummy phase for read-status register operations. It is only valid when SPI\_SLV\_RDSTA\_DUMMY\_EN is set to 1 in slave half-duplex mode. (R/W)

**Register 7.18. SPI\_SLAVE3\_REG (0x44)**

<i>SPI_SLV_WRSTA_CMD_VALUE</i>								<i>SPI_SLV_RDSTA_CMD_VALUE</i>								<i>SPI_SLV_WRBUF_CMD_VALUE</i>								<i>SPI_SLV_RDBUF_CMD_VALUE</i>								
31								24	23							16	15			8	7							0				
0 0 0 0 0 0 0 0								0 0 0 0 0 0 0 0								0 0 0 0 0 0 0 0								0 0 0 0 0 0 0 0								Reset

**SPI\_SLV\_WRSTA\_CMD\_VALUE** Reserved.

**SPI\_SLV\_RDSTA\_CMD\_VALUE** Reserved.

**SPI\_SLV\_WRBUF\_CMD\_VALUE** Reserved.

**SPI\_SLV\_RDBUF\_CMD\_VALUE** Reserved.

Register 7.19. SPI\_SLV\_WRBUF\_DLEN\_REG (0x48)

31	24	23	0
(reserved)		SPI_SLV_WRBUF_DBITLEN	
0 0 0 0 0 0 0 0		0x0000000	
			Reset

**SPI\_SLV\_WRBUF\_DBITLEN** It indicates the length of written data minus one, in multiples of one bit. It is only valid in slave half-duplex mode. (R/W)

Register 7.20. SPI\_SLV\_RDBUF\_DLEN\_REG (0x4C)

31	24	23	0
(reserved)		SPI_SLV_RDBUF_DBITLEN	
0 0 0 0 0 0 0 0		0x0000000	
			Reset

**SPI\_SLV\_RDBUF\_DBITLEN** It indicates the length of read data minus one, in multiples of one bit. It is only valid in slave half-duplex mode. (R/W)

Register 7.21. SPI\_SLV\_RD\_BIT\_REG (0x64)

31	24	23	0
(reserved)		SPI_SLV_RDATA_BIT	
0 0 0 0 0 0 0 0		0 0	
			Reset

**SPI\_SLV\_RDATA\_BIT** It indicates the bit length of data the master reads from the slave, minus one. It is only valid in slave half-duplex mode. (R/W)

Register 7.22. SPI\_W<sub>n</sub>\_REG (*n*: 0-15) (0x80+4\**n*)

31	0
0 0	
Reset	

**SPI\_W<sub>n</sub>\_REG** Data buffer. (R/W)

**Register 7.23. SPI\_TX\_CRC\_REG (0xC0)**

31	0
0 0	
Reset	

**SPI\_TX\_CRC\_REG** Reserved.

**Register 7.24. SPI\_EXT2\_REG (0xF8)**

31	<i>(reserved)</i>		3	2	0
<i>SPI_ST</i>					
0 0					
Reset					

**SPI\_ST** The current state of the SPI state machine: (RO)

- 0: idle state
- 1: preparation state
- 2: send command state
- 3: send data state
- 4: read data state
- 5: write data state
- 6: wait state
- 7: done state

**Register 7.25. SPI\_DMA\_CONF\_REG (0x100)**

(reserved)																	17	16	15	14	13	12	11	10	9	8	6	5	4	3	2	1	0		
																	0	0	0	0	0	0	0	0	0	0	0	0	0	0	0	0	0	0	0

Reset

- SPI\_DMA\_CONTINUE** This bit enables SPI DMA continuous data TX/RX mode. (R/W)
- SPI\_DMA\_TX\_STOP** When in continuous TX/RX mode, setting this bit stops sending data. (R/W)
- SPI\_DMA\_RX\_STOP** When in continuous TX/RX mode, setting this bit stops receiving data. (R/W)
- SPI\_OUT\_DATA\_BURST\_EN** SPI DMA reads data from memory in burst mode. (R/W)
- SPI\_INDSCLR\_BURST\_EN** SPI DMA reads inlink descriptor in burst mode. (R/W)
- SPI\_OUTDSCLR\_BURST\_EN** SPI DMA reads outlink descriptor in burst mode. (R/W)
- SPI\_OUT\_EOF\_MODE** DMA out-EOF-flag generation mode. (R/W)
  - 1: out-EOF-flag is generated when DMA has popped all data from the FIFO;
  - 0: out-EOF-flag is generated when DMA has pushed all data to the FIFO.
- SPI\_AHBM\_RST** reset SPI DMA AHB master. (R/W)
- SPI\_AHBM\_FIFO\_RST** This bit is used to reset SPI DMA AHB master FIFO pointer. (R/W)
- SPI\_OUT\_RST** The bit is used to reset DMA out-FSM and out-data FIFO pointer. (R/W)
- SPI\_IN\_RST** The bit is used to reset DMA in-DSM and in-data FIFO pointer. (R/W)

**Register 7.26. SPI\_DMA\_OUT\_LINK\_REG (0x104)**

(reserved)				31	30	29	28	27	(reserved)										20	19	0
				0	0	0	0	0											0	0	0

Reset

- SPI\_OUTLINK\_RESTART** Set the bit to add new outlink descriptors. (R/W)
- SPI\_OUTLINK\_START** Set the bit to start to use outlink descriptor. (R/W)
- SPI\_OUTLINK\_STOP** Set the bit to stop to use outlink descriptor. (R/W)
- SPI\_OUTLINK\_ADDR** The address of the first outlink descriptor. (R/W)

## Register 7.27. SPI\_DMA\_IN\_LINK\_REG (0x108)

(reserved)					(reserved)							(reserved)										SPI_INLINK_ADDR			0	Reset
31	30	29	28	27	21	20	19														0					
0	0	0	0	0	0	0	0	0x000000													0					

**SPI\_INLINK\_RESTART** Set the bit to add new inlink descriptors. (R/W)

**SPI\_INLINK\_START** Set the bit to start to use inlink descriptor. (R/W)

**SPI\_INLINK\_STOP** Set the bit to stop to use inlink descriptor. (R/W)

**SPI\_INLINK\_AUTO\_RET** when the bit is set, inlink descriptor jumps to the next descriptor when a packet is invalid. (R/W)

**SPI\_INLINK\_ADDR** The address of the first inlink descriptor. (R/W)

## Register 7.28. SPI\_DMA\_STATUS\_REG (0x10C)

(reserved)																												(reserved)			2	1	0	Reset
																															0	0	0	
31	30	29	28	27	26	25	24	23	22	21	20	19	18	17	16	15	14	13	12	11	10	9	8	7	6	5	4	3	2	1	0			
0	0	0	0	0	0	0	0	0	0	0	0	0	0	0	0	0	0	0	0	0	0	0	0	0	0	0	0	0	0	0	0	0		

**SPI\_DMA\_TX\_EN** SPI DMA write-data status bit. (RO)

**SPI\_DMA\_RX\_EN** SPI DMA read-data status bit. (RO)

## Register 7.29. SPI\_DMA\_INT\_ENA\_REG (0x110)

(reserved)										SPI_OUT_TOTAL_EOF_INT_ENA SPI_OUT_EOF_INT_ENA SPI_OUT_DONE_INT_ENA SPI_IN_SUC_EOF_INT_ENA SPI_IN_ERR_EOF_INT_ENA SPI_IN_DONE_INT_ENA SPI_INLINK_DSCR_ERROR_INT_ENA SPI_OUTLINK_DSCR_ERROR_INT_ENA SPI_INLINK_DSCR_EMPTY_INT_ENA																											
31																			9	8	7	6	5	4	3	2	1	0	Reset								
0																			0	0	0	0	0	0	0	0	0	0	0	0	0	0	0	0	0	0	0

**SPI\_OUT\_TOTAL\_EOF\_INT\_ENA** The interrupt enable bit for the [SPI\\_OUT\\_TOTAL\\_EOF\\_INT](#) interrupt. (R/W)

**SPI\_OUT\_EOF\_INT\_ENA** The interrupt enable bit for the [SPI\\_OUT\\_EOF\\_INT](#) interrupt. (R/W)

**SPI\_OUT\_DONE\_INT\_ENA** The interrupt enable bit for the [SPI\\_OUT\\_DONE\\_INT](#) interrupt. (R/W)

**SPI\_IN\_SUC\_EOF\_INT\_ENA** The interrupt enable bit for the [SPI\\_IN\\_SUC\\_EOF\\_INT](#) interrupt. (R/W)

**SPI\_IN\_ERR\_EOF\_INT\_ENA** The interrupt enable bit for the [SPI\\_IN\\_ERR\\_EOF\\_INT](#) interrupt. (R/W)

**SPI\_IN\_DONE\_INT\_ENA** The interrupt enable bit for the [SPI\\_IN\\_DONE\\_INT](#) interrupt. (R/W)

**SPI\_INLINK\_DSCR\_ERROR\_INT\_ENA** The interrupt enable bit for the [SPI\\_INLINK\\_DSCR\\_ERROR\\_INT](#) interrupt. (R/W)

**SPI\_OUTLINK\_DSCR\_ERROR\_INT\_ENA** The interrupt enable bit for the [SPI\\_OUTLINK\\_DSCR\\_ERROR\\_INT](#) interrupt. (R/W)

**SPI\_INLINK\_DSCR\_EMPTY\_INT\_ENA** The interrupt enable bit for the [SPI\\_INLINK\\_DSCR\\_EMPTY\\_INT](#) interrupt. (R/W)



## Register 7.30. SPI\_DMA\_INT\_RAW\_REG (0x114)

(reserved)										SPI_OUT_TOTAL_EOF_INT_RAW SPI_OUT_EOF_INT_RAW SPI_OUT_DONE_INT_RAW SPI_IN_SUC_EOF_INT_RAW SPI_IN_ERR_EOF_INT_RAW SPI_IN_DONE_INT_RAW SPI_OUTLINK_DSCR_ERROR_INT_RAW SPI_INLINK_DSCR_EMPTY_INT_RAW											
31										9	8	7	6	5	4	3	2	1	0		
0	0	0	0	0	0	0	0	0	0	0	0	0	0	0	0	0	0	0	0	0	Reset

**SPI\_OUT\_TOTAL\_EOF\_INT\_RAW** The raw interrupt status bit for the [SPI\\_OUT\\_TOTAL\\_EOF\\_INT](#) interrupt. (RO)

**SPI\_OUT\_EOF\_INT\_RAW** The raw interrupt status bit for the [SPI\\_OUT\\_EOF\\_INT](#) interrupt. (RO)

**SPI\_OUT\_DONE\_INT\_RAW** The raw interrupt status bit for the [SPI\\_OUT\\_DONE\\_INT](#) interrupt. (RO)

**SPI\_IN\_SUC\_EOF\_INT\_RAW** The raw interrupt status bit for the [SPI\\_IN\\_SUC\\_EOF\\_INT](#) interrupt. (RO)

**SPI\_IN\_ERR\_EOF\_INT\_RAW** The raw interrupt status bit for the [SPI\\_IN\\_ERR\\_EOF\\_INT](#) interrupt. (RO)

**SPI\_IN\_DONE\_INT\_RAW** The raw interrupt status bit for the [SPI\\_IN\\_DONE\\_INT](#) interrupt. (RO)

**SPI\_INLINK\_DSCR\_ERROR\_INT\_RAW** The raw interrupt status bit for the [SPI\\_INLINK\\_DSCR\\_ERROR\\_INT](#) interrupt. (RO)

**SPI\_OUTLINK\_DSCR\_ERROR\_INT\_RAW** The raw interrupt status bit for the [SPI\\_OUTLINK\\_DSCR\\_ERROR\\_INT](#) interrupt. (RO)

**SPI\_INLINK\_DSCR\_EMPTY\_INT\_RAW** The raw interrupt status bit for the [SPI\\_INLINK\\_DSCR\\_EMPTY\\_INT](#) interrupt. (RO)

Register 7.31. SPI\_DMA\_INT\_ST\_REG (0x118)

(reserved)																SPI_OUT_TOTAL_EOF_INT_ST SPI_OUT_EOF_INT_ST SPI_OUT_DONE_INT_ST SPI_IN_SUC_EOF_INT_ST SPI_IN_ERR_EOF_INT_ST SPI_IN_DONE_INT_ST SPI_OUTLINK_DSCR_ERROR_INT_ST SPI_INLINK_DSCR_ERROR_INT_ST SPI_INLINK_DSCR_EMPTY_INT_ST														
31																9	8	7	6	5	4	3	2	1	0	Reset				
0																0	0	0	0	0	0	0	0	0	0	0	0	0	0	0

**SPI\_OUT\_TOTAL\_EOF\_INT\_ST** The masked interrupt status bit for the [SPI\\_OUT\\_TOTAL\\_EOF\\_INT](#) interrupt. (RO)

**SPI\_OUT\_EOF\_INT\_ST** The masked interrupt status bit for the [SPI\\_OUT\\_EOF\\_INT](#) interrupt. (RO)

**SPI\_OUT\_DONE\_INT\_ST** The masked interrupt status bit for the [SPI\\_OUT\\_DONE\\_INT](#) interrupt. (RO)

**SPI\_IN\_SUC\_EOF\_INT\_ST** The masked interrupt status bit for the [SPI\\_IN\\_SUC\\_EOF\\_INT](#) interrupt. (RO)

**SPI\_IN\_ERR\_EOF\_INT\_ST** The masked interrupt status bit for the [SPI\\_IN\\_ERR\\_EOF\\_INT](#) interrupt. (RO)

**SPI\_IN\_DONE\_INT\_ST** The masked interrupt status bit for the [SPI\\_IN\\_DONE\\_INT](#) interrupt. (RO)

**SPI\_INLINK\_DSCR\_ERROR\_INT\_ST** The masked interrupt status bit for the [SPI\\_INLINK\\_DSCR\\_ERROR\\_INT](#) interrupt. (RO)

**SPI\_OUTLINK\_DSCR\_ERROR\_INT\_ST** The masked interrupt status bit for the [SPI\\_OUTLINK\\_DSCR\\_ERROR\\_INT](#) interrupt. (RO)

**SPI\_INLINK\_DSCR\_EMPTY\_INT\_ST** The masked interrupt status bit for the [SPI\\_INLINK\\_DSCR\\_EMPTY\\_INT](#) interrupt. (RO)

**Register 7.32. SPI\_DMA\_INT\_CLR\_REG (0x11C)**

31	(reserved)											9	8	7	6	5	4	3	2	1	0	Reset
0																						

SPI\_OUT\_TOTAL\_EOF\_INT\_CLR  
 SPI\_OUT\_EOF\_INT\_CLR  
 SPI\_OUT\_DONE\_INT\_CLR  
 SPI\_IN\_SUC\_EOF\_INT\_CLR  
 SPI\_IN\_ERR\_EOF\_INT\_CLR  
 SPI\_IN\_DONE\_INT\_CLR  
 SPI\_INLINK\_DSCR\_ERROR\_INT\_CLR  
 SPI\_OUTLINK\_DSCR\_ERROR\_INT\_CLR  
 SPI\_INLINK\_DSCR\_EMPTY\_INT\_CLR

**SPI\_OUT\_TOTAL\_EOF\_INT\_CLR** Set this bit to clear the [SPI\\_OUT\\_TOTAL\\_EOF\\_INT](#) interrupt. (R/W)

**SPI\_OUT\_EOF\_INT\_CLR** Set this bit to clear the [SPI\\_OUT\\_EOF\\_INT](#) interrupt. (R/W)

**SPI\_OUT\_DONE\_INT\_CLR** Set this bit to clear the [SPI\\_OUT\\_DONE\\_INT](#) interrupt. (R/W)

**SPI\_IN\_SUC\_EOF\_INT\_CLR** Set this bit to clear the [SPI\\_IN\\_SUC\\_EOF\\_INT](#) interrupt. (R/W)

**SPI\_IN\_ERR\_EOF\_INT\_CLR** Set this bit to clear the [SPI\\_IN\\_ERR\\_EOF\\_INT](#) interrupt. (R/W)

**SPI\_IN\_DONE\_INT\_CLR** Set this bit to clear the [SPI\\_IN\\_DONE\\_INT](#) interrupt. (R/W)

**SPI\_INLINK\_DSCR\_ERROR\_INT\_CLR** Set this bit to clear the [SPI\\_INLINK\\_DSCR\\_ERROR\\_INT](#) interrupt. (R/W)

**SPI\_OUTLINK\_DSCR\_ERROR\_INT\_CLR** Set this bit to clear the [SPI\\_OUTLINK\\_DSCR\\_ERROR\\_INT](#) interrupt. (R/W)

**SPI\_INLINK\_DSCR\_EMPTY\_INT\_CLR** Set this bit to clear the [SPI\\_INLINK\\_DSCR\\_EMPTY\\_INT](#) interrupt. (R/W)

**Register 7.33. SPI\_IN\_ERR\_EOF\_DES\_ADDR\_REG (0x120)**

31																																0
0																																

**SPI\_IN\_ERR\_EOF\_DES\_ADDR\_REG** The inlink descriptor address when SPI DMA encountered an error in receiving data. (RO)

**Register 7.34. SPI\_IN\_SUC\_EOF\_DES\_ADDR\_REG (0x124)**

31																																0
0																																

**SPI\_IN\_SUC\_EOF\_DES\_ADDR\_REG** The last inlink descriptor address when SPI DMA encountered EOF. (RO)

**Register 7.35. SPI\_INLINK\_DSCR\_REG (0x128)**

31	0
0 0	

Reset

**SPI\_INLINK\_DSCR\_REG** The address of the current inlink descriptor. (RO)

**Register 7.36. SPI\_INLINK\_DSCR\_BF0\_REG (0x12C)**

31	0
0 0	

Reset

**SPI\_INLINK\_DSCR\_BF0\_REG** The address of the next inlink descriptor. (RO)

**Register 7.37. SPI\_INLINK\_DSCR\_BF1\_REG (0x130)**

31	0
0 0	

Reset

**SPI\_INLINK\_DSCR\_BF1\_REG** The address of the next inlink data buffer. (RO)

**Register 7.38. SPI\_OUT\_EOF\_BFR\_DES\_ADDR\_REG (0x134)**

31	0
0 0	

Reset

**SPI\_OUT\_EOF\_BFR\_DES\_ADDR\_REG** The buffer address corresponding to the outlink descriptor that produces EOF. (RO)

**Register 7.39. SPI\_OUT\_EOF\_DES\_ADDR\_REG (0x138)**

31	0
0 0	

Reset

**SPI\_OUT\_EOF\_DES\_ADDR\_REG** The last outlink descriptor address when SPI DMA encountered EOF. (RO)

**Register 7.40. SPI\_OUTLINK\_DSCR\_REG (0x13C)**

31	0
0 0	Reset

**SPI\_OUTLINK\_DSCR\_REG** The address of the current outlink descriptor. (RO)

**Register 7.41. SPI\_OUTLINK\_DSCR\_BF0\_REG (0x140)**

31	0
0 0	Reset

**SPI\_OUTLINK\_DSCR\_BF0\_REG** The address of the next outlink descriptor. (RO)

**Register 7.42. SPI\_OUTLINK\_DSCR\_BF1\_REG (0x144)**

31	0
0 0	Reset

**SPI\_OUTLINK\_DSCR\_BF1\_REG** The address of the next outlink data buffer. (RO)

**Register 7.43. SPI\_DMA\_RSTATUS\_REG (0x148)**

<i>TX_FIFO_EMPTY</i>	<i>TX_FIFO_FULL</i>	<i>(reserved)</i>	<i>TX_DES_ADDRESS</i>
31	30	29	20
19			0
0	0	0 0 0 0 0 0 0 0 0 0 0 0	0 0
			Reset

**TX\_FIFO\_EMPTY** The SPI DMA TX FIFO is empty. (RO)

**TX\_FIFO\_FULL** The SPI DMA TX FIFO is full. (RO)

**TX\_DES\_ADDRESS** The LSB of the SPI DMA outlink descriptor address. (RO)



## 8 SDIO Slave Controller

### 8.1 Overview

The ESP32 features hardware support for the industry-standard Secure Digital (SD) device interface that conforms to the SD Input/Output (SDIO) Specification Version 2.0. This allows a host controller to access the ESP32 via an SDIO bus protocol, enabling high-speed data transfer.

The SDIO interface may be used to read ESP32 SDIO registers directly and access shared memory via Direct Memory Access (DMA), thus reducing processing overhead while maintaining high performance.

### 8.2 Features

- Meets SDIO V2.0 specification
- Supports SDIO SPI, 1-bit, and 4-bit transfer modes
- Full host clock range of 0 ~ 50 MHz
- Configurable sample and drive clock edge
- Integrated, SDIO-accessible registers for information interaction
- Supports SDIO interrupt mechanism
- Automatic data padding
- Block size of up to 512 bytes
- Interrupt vector between Host and Slave for bidirectional interrupt
- Supports DMA for data transfer

### 8.3 Functional Description

#### 8.3.1 SDIO Slave Block Diagram

The functional block diagram of the SDIO slave module is shown in Figure 8-1.

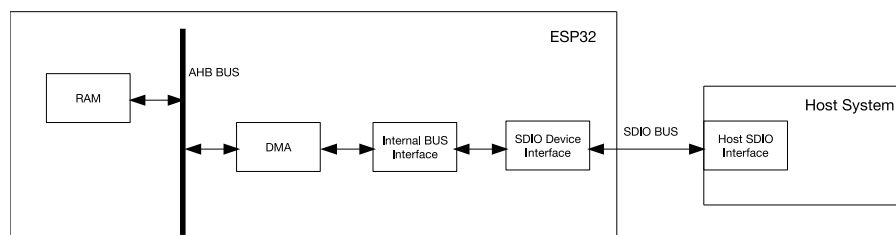


Figure 8-1. SDIO Slave Block Diagram

The Host System represents any SDIO specification V2.0-compatible host device. The Host System interacts with the ESP32 (configured as the SDIO slave) via the standard SDIO bus implementation.

The SDIO Device Interface block enables effective communication with the external Host by directly providing SDIO interface registers and enabling DMA operation for high-speed data transfer over the Advanced High-performance Bus (AHB) without engaging the CPU.

### 8.3.2 Sending and Receiving Data on SDIO Bus

Data is transmitted between Host and Slave through the SDIO bus I/O Function1. After the Host enables the I/O Function1 in the Slave, according to the SDIO protocol, data transmission will begin.

ESP32 segregates data into packets sent to/from the Host. To achieve high bus utilization and data transfer rates, we recommend the single block transmission mode. For detailed information on this mode, please refer to the SDIO V2.0 protocol specification. When Host and Slave exchange data as blocks on the SDIO bus, the Slave automatically pads data-when sending data out-and automatically strips padding data from the incoming data block.

Whether the Slave pads or discards the data depends on the data address on the SDIO bus. When the data address is equal to, or greater than, 0x1F800, the Slave will start padding or discarding data. Therefore, the starting data address should be 0x1F800 - Packet\_length, where Packet\_length is measured in bytes. Data flow on the SDIO bus is shown in Figure 8-2.

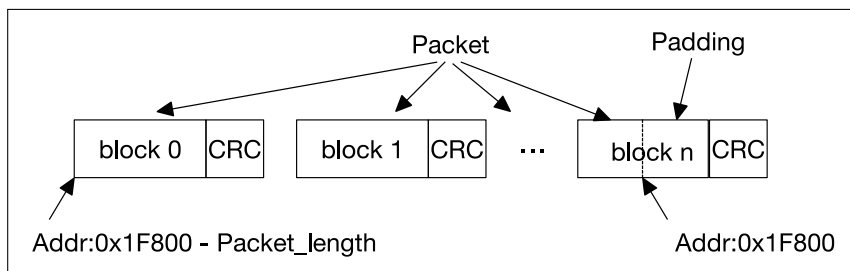


Figure 8-2. SDIO Bus Packet Transmission

The standard IO\_RW\_EXTENDED (CMD53) command is used to initiate a packet transfer of an arbitrary length. The content of the CMD53 command used in data transmission is as illustrated in Figure 8-3 below. For detailed information on CMD53, please refer to the SDIO protocol specifications.

S	D	Command Index 110101b	R/W flag	Function Number 001b	Block Mode 1b	OP Code 1b	Register Address 0X1F800-Packet_length	Byte/Block Count Roundup (Packet_length/Block_size)	CRC7	E
1	1	6	1	3	1	1	17	9	7	1

Figure 8-3. CMD53 Content

### 8.3.3 Register Access

For effective interaction between Host and Slave, the Host can access certain registers in the Slave via the SDIO bus I/O Function1. These registers are in continuous address fields from SLC0HOST\_TOKEN\_RDATA to SLCHOST\_INF\_ST. The Host device can access these registers by simply setting the register addresses of CMD52 or CMD53 to the low 10 bits of the corresponding register address. The Host can access several consecutive registers at one go with CMD53, thus achieving a higher effective transfer rate.

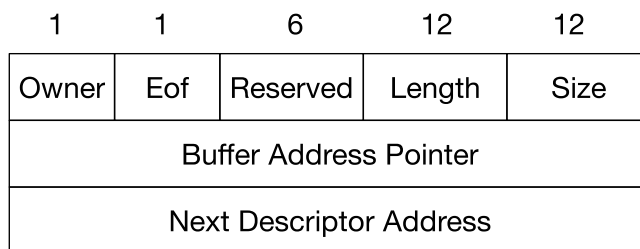
There are 54 bytes of field between SLCHOST\_CONF\_W0\_REG and SLCHOST\_CONF\_W15\_REG. Host and Slave can access and change these fields, thus facilitating the information interaction between Host and Slave.

### 8.3.4 DMA

The SDIO Slave module uses dedicated DMA to access data residing in the RAM. As shown in Figure 8-1, the RAM is accessed over the AHB. DMA accesses RAM through a linked-list descriptor. Every linked list is



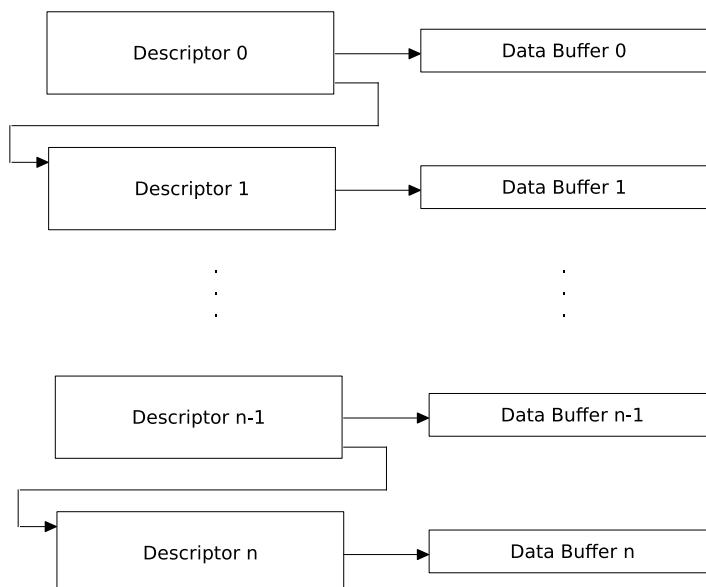
composed of three words, as shown in Figure 8-4.



**Figure 8-4. SDIO Slave DMA Linked List Structure**

- Owner: The allowed operator of the buffer that corresponds to the current linked list. 0: CPU is the allowed operator; 1: DMA is the allowed operator.
- Eof: End-of-file marker, indicating that this linked-list element is the last element of the data packet.
- Length: The number of valid bytes in the buffer, i.e., the number of bytes that should be accessed from the buffer for reading/writing.
- Size: The maximum number of available buffers.
- Buffer Address Pointer: The address of the data buffer as seen by the CPU (according to the RAM address space).
- Next Descriptor Address: The address of the next linked-list element in the CPU RAM address space. If the current linked list is the last one, the Eof bit should be 1, and the last descriptor address should be 0.

The Slave's linked-list chain is shown in Figure 8-5:



**Figure 8-5. SDIO Slave Linked List**

### 8.3.5 Packet-Sending/-Receiving Procedure

The SDIO Host and Slave devices need to follow specific data transfer procedures to successfully exchange data over the SDIO interface.

### 8.3.5.1 Sending Packets to SDIO Host

The transmission of packets from Slave to Host is initiated by the Slave. The Host will be notified with an interrupt (for detailed information on interrupts, please refer to SDIO protocol). After the Host reads the relevant information from the Slave, it will initiate an SDIO bus transaction accordingly. The whole procedure is illustrated in Figure 8-6.

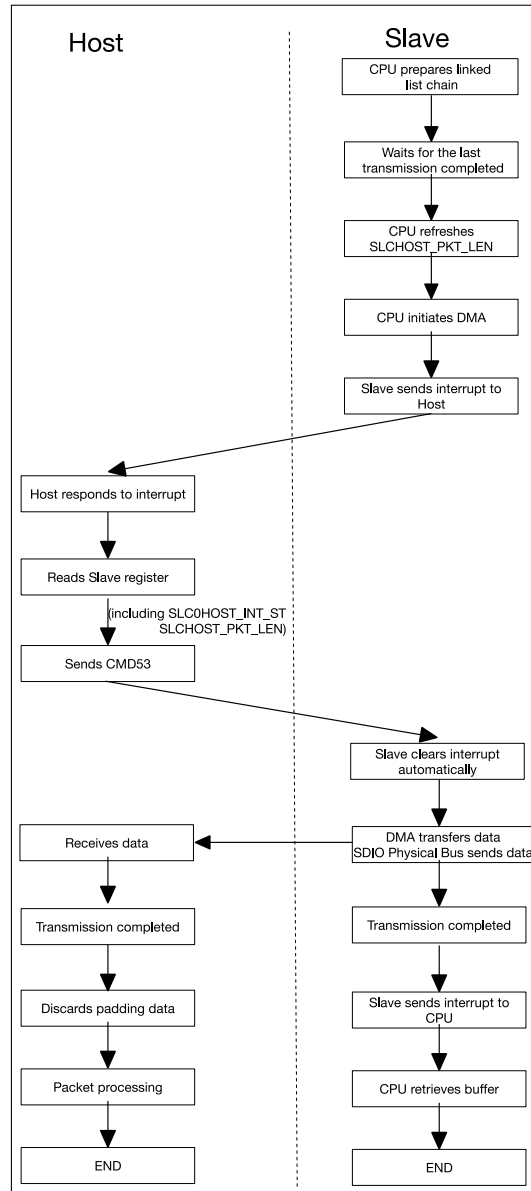


Figure 8-6. Packet Sending Procedure (Initiated by Slave)

When the Host is interrupted, it reads relevant information from the Slave by visiting registers SLC0HOST\_INT and SLCHOST\_PKT\_LEN.

- SLC0HOST\_INT: Interrupt status register. If the value of SLC0\_RX\_NEW\_PACKET\_INT\_ST is 1, this indicates that the Slave has a packet to send.
- SLCHOST\_PKT\_LEN: Packet length accumulator register. The current value minus the value of last time equals the packet length sent this time.

In order to start DMA, the CPU needs to write the low 20 bits of the address of the first linked-list element to the

SLC0\_RXLINK\_ADDR bit of SLC0RX\_LINK, then set the SLC0\_RXLINK\_START bit of SLC0RX\_LINK. The DMA will automatically complete the data transfer. Upon completion of the operation, DMA will interrupt the CPU so that the buffer space can be freed or reused.

### 8.3.5.2 Receiving Packets from SDIO Host

Transmission of packets from Host to Slave is initiated by the Host. The Slave receives data via DMA and stores it in RAM. After transmission is completed, the CPU will be interrupted to process the data. The whole procedure is demonstrated in Figure 8-7.

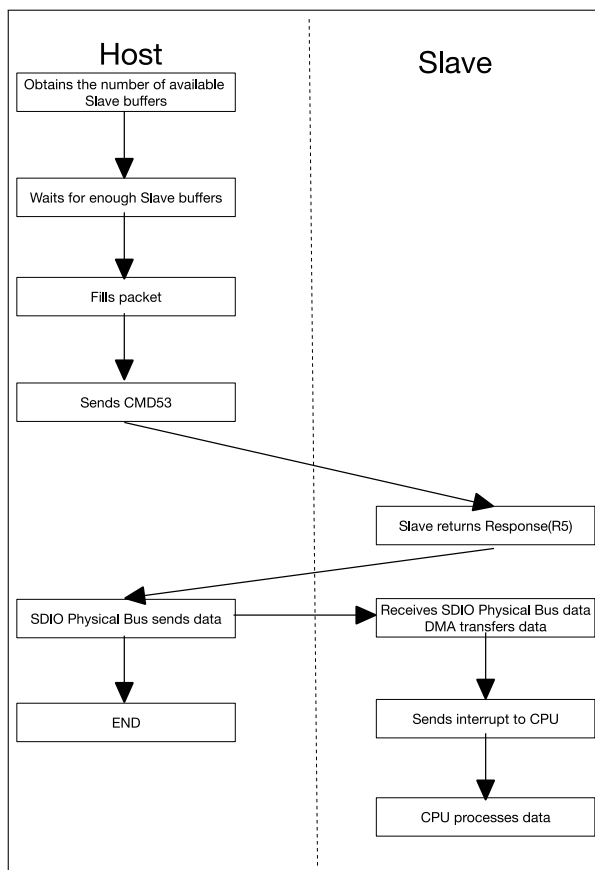


Figure 8-7. Packet Receiving Procedure (Initiated by Host)

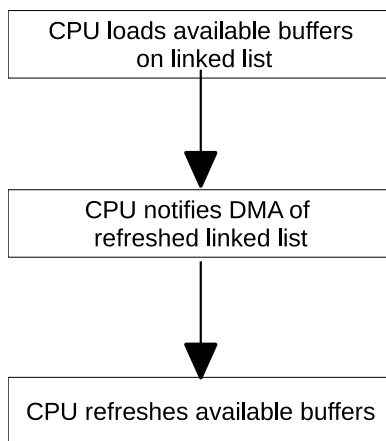
The Host obtains the number of available receiving buffers from the Slave by accessing register SLC0HOST\_TOKEN\_RDATA. The Slave CPU should update this value after the receiving DMA linked list is prepared.

HOSTREG\_SLC0\_TOKEN1 in SLC0HOST\_TOKEN\_RDATA stores the accumulated number of available buffers.

The Host can figure out the available buffer space, using HOSTREG\_SLC0\_TOKEN1 minus the number of buffers already used.

If the buffers are not enough, the Host needs to constantly poll the register until there are enough buffers available.

To ensure sufficient receiving buffers, the Slave CPU must constantly load buffers on the receiving linked list. The process is shown in Figure 8-8.



**Figure 8-8. Loading Receiving Buffer**

The CPU first needs to append new buffer segments at the end of the linked list that is being used by DMA and is available for receiving data.

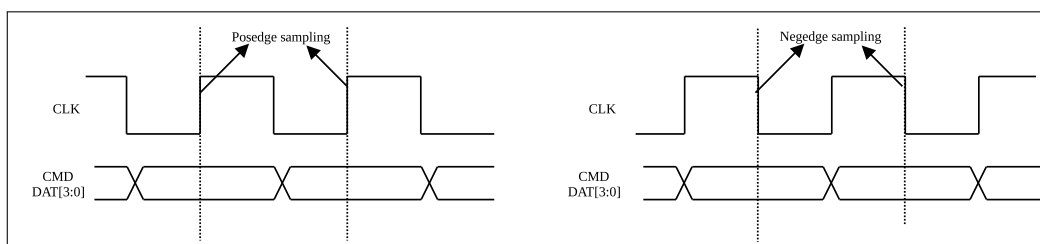
The CPU then needs to notify the DMA that the linked list has been modified. This can be done by setting bit `SLC0_TXLINK_RESTART` of the `SLC0TX_LINK` register. Please note that when the CPU initiates DMA to receive packets for the first time, `SLC0_TXLINK_RESTART` should be set to 1.

Lastly, the CPU refreshes any available buffer information by writing to the `SLC0TOKEN1` register.

### 8.3.6 SDIO Bus Timing

The SDIO bus operates at a very high speed and the PCB trace length usually affects signal integrity by introducing latency. To ensure that the timing characteristics conform to the desired bus timing, the SDIO Slave module supports configuration of input sampling clock edge and output driving clock edge.

When the incoming data changes near the rising edge of the clock, the Slave will perform sampling on the falling edge of the clock, or vice versa, as Figure 8-9 shows.



**Figure 8-9. Sampling Timing Diagram**

By default, the `MTDO` strapping value determines the Slave's sampling edge. However, users can decide the sampling edge by configuring the `SLCHOST_CONF_REG` register, with priority from high to low: (1) Set `SLCHOST_FRC_POS_SAMP` to sample the corresponding signal at the rising edge; (2) Set `SLCHOST_FRC_NEG_SAMP` to sample the corresponding signal at the falling edge.

`SLCHOST_FRC_POS_SAMP` and `SLCHOST_FRC_NEG_SAMP` fields are five bits wide. The bits correspond to the `CMD` line and four `DATA` lines (0-3). Setting a bit causes the corresponding line to be sampled for input at the rising clock edge or falling clock edge.

The Slave can also select which edge to drive the output lines, in order to accommodate for any latency caused by the physical signal path. The output timing is shown in Figure 8-10.

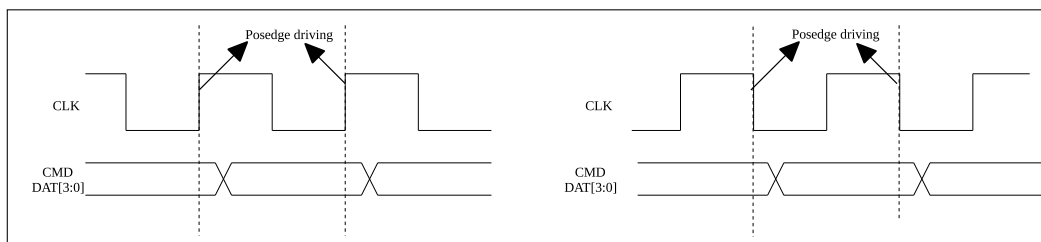


Figure 8-10. Output Timing Diagram

By default, the GPIO5 strapping value determines the Slave's output driving edge. However, users can decide the output driving edge by configuring the following registers, with priority from high to low: (1) Set `SLCHOST_FRC_SDIO11` in `SLCHOST_CONF_REG` to output the corresponding signal at the falling clock edge; (2) Set `SLCHOST_FRC_SDIO22` in `SLCHOST_CONF_REG` to output the corresponding signal at the rising clock edge; (3) Set `HINF_HIGHSPEED_ENABLE` in `HINF_CFG_DATA1_REG` and `SLCHOST_HSPEED_CON_EN` in `SLCHOST_CONF_REG`, then set the EHS (Enable High-Speed) bit in `CCCR` at the Host side to output the corresponding signal at the rising clock edge.

`SLCHOST_FRC_SDIO11` and `SLCHOST_FRC_SDIO22` fields are five bits wide. The bits correspond to the CMD line and four DATA lines (0-3). Setting a bit causes the corresponding line to output at the rising clock edge or falling clock edge.

**Notes on priority setting:** The configuration of strapping pins has the lowest priority when controlling the sampling edge or driving edge. The lower-priority configuration takes effect only when the higher-priority configuration is not set. For example, the `MTDO` strapping value determines the sampling edge only when `SCLHOST_FRC_POS_SAMP` and `SCLHOST_FRC_NEG_SAMP` are not set.

### 8.3.7 Interrupt

Host and Slave can interrupt each other via the interrupt vector. Both Host and Slave have eight interrupt vectors. The interrupt is enabled by configuring the interrupt vector register (setting the enable bit to 1). The interrupt vector registers can clear themselves automatically, which means one interrupt at a time and no other configuration is required.

#### 8.3.7.1 Host Interrupt

- `SLC0HOST_SLC0_RX_NEW_PACKET_INT` Slave has a packet to send.
- `SLC0HOST_SLC0_TX_OVF_INT` Slave receiving buffer overflow interrupt.
- `SLC0HOST_SLC0_RX_UDF_INT` Slave sending buffer underflow interrupt.
- `SLC0HOST_SLC0_TOHOST_BITn_INT` ( $n$ : 0 ~ 7) Slave interrupts Host.

#### 8.3.7.2 Slave Interrupt

- `SLC0INT_SLC0_RX_DSCR_ERR_INT` Slave sending descriptor error.
- `SLC0INT_SLC0_TX_DSCR_ERR_INT` Slave receiving descriptor error.

- *SLC0INT\_SLC0\_RX\_EOF\_INT* Slave sending operation is finished.
- *SLC0INT\_SLC0\_RX\_DONE\_INT* A single buffer is sent by Slave.
- *SLC0INT\_SLC0\_TX\_SUC\_EOF\_INT* Slave receiving operation is finished.
- *SLC0INT\_SLC0\_TX\_DONE\_INT* A single buffer is finished during receiving operation.
- *SLC0INT\_SLC0\_TX\_OVF\_INT* Slave receiving buffer overflow interrupt.
- *SLC0INT\_SLC0\_RX\_UDF\_INT* Slave sending buffer underflow interrupt.
- *SLC0INT\_SLC0\_TX\_START\_INT* Slave receiving interrupt initialization.
- *SLC0INT\_SLC0\_RX\_START\_INT* Slave sending interrupt initialization.
- *SLC0INT\_SLC\_FRHOST\_BITn\_INT* (*n*: 0 ~ 7) Host interrupts Slave.

## 8.4 Register Summary

Name	Description	Address	Access
<b>SDIO DMA (SLC) configuration registers</b>			
<a href="#">SLCCONF0_REG</a>	SLCCONF0_SLC configuration	0x3FF58000	R/W
<a href="#">SLC0RX_LINK_REG</a>	Transmitting linked list configuration	0x3FF5803C	R/W
<a href="#">SLC0TX_LINK_REG</a>	Receiving linked list configuration	0x3FF58040	R/W
<a href="#">SLCINTVEC_TOHOST_REG</a>	Interrupt sector for Slave to interrupt Host	0x3FF5804C	WO
<a href="#">SLC0TOKEN1_REG</a>	Number of receiving buffer	0x3FF58054	WO
<a href="#">SLCCONF1_REG</a>	Control register	0x3FF58060	R/W
<a href="#">SLC_RX_DSCR_CONF_REG</a>	DMA transmission configuration	0x3FF58098	R/W
<a href="#">SLC0_LEN_CONF_REG</a>	Length control of the transmitting packets	0x3FF580E4	R/W
<a href="#">SLC0_LENGTH_REG</a>	Length of the transmitting packets	0x3FF580E8	R/W
<b>Interrupt Registers</b>			
<a href="#">SLC0INT_RAW_REG</a>	Raw interrupt status	0x3FF58004	RO
<a href="#">SLC0INT_ST_REG</a>	Interrupt status	0x3FF58008	RO
<a href="#">SLC0INT_ENA_REG</a>	Interrupt enable	0x3FF5800C	R/W
<a href="#">SLC0INT_CLR_REG</a>	Interrupt clear	0x3FF58010	WO

Name	Description	Address	Access
<b>SDIO SLC Host registers</b>			
<a href="#">SLC0HOST_TOKEN_RDATA</a>	The accumulated number of Slave's receiving buffers	0x3FF55044	RO
<a href="#">SLCHOST_PKT_LEN_REG</a>	Length of the transmitting packets	0x3FF55060	RO
<a href="#">SLCHOST_CONF_W0_REG</a>	Host and Slave communication register0	0x3FF5506C	R/W
<a href="#">SLCHOST_CONF_W1_REG</a>	Host and Slave communication register1	0x3FF55070	R/W
<a href="#">SLCHOST_CONF_W2_REG</a>	Host and Slave communication register2	0x3FF55074	R/W
<a href="#">SLCHOST_CONF_W3_REG</a>	Host and Slave communication register3	0x3FF55078	R/W
<a href="#">SLCHOST_CONF_W4_REG</a>	Host and Slave communication register4	0x3FF5507C	R/W
<a href="#">SLCHOST_CONF_W6_REG</a>	Host and Slave communication register6	0x3FF55088	R/W
<a href="#">SLCHOST_CONF_W7_REG</a>	Interrupt vector for Host to interrupt Slave	0x3FF5508C	WO
<a href="#">SLCHOST_CONF_W8_REG</a>	Host and Slave communication register8	0x3FF5509C	R/W

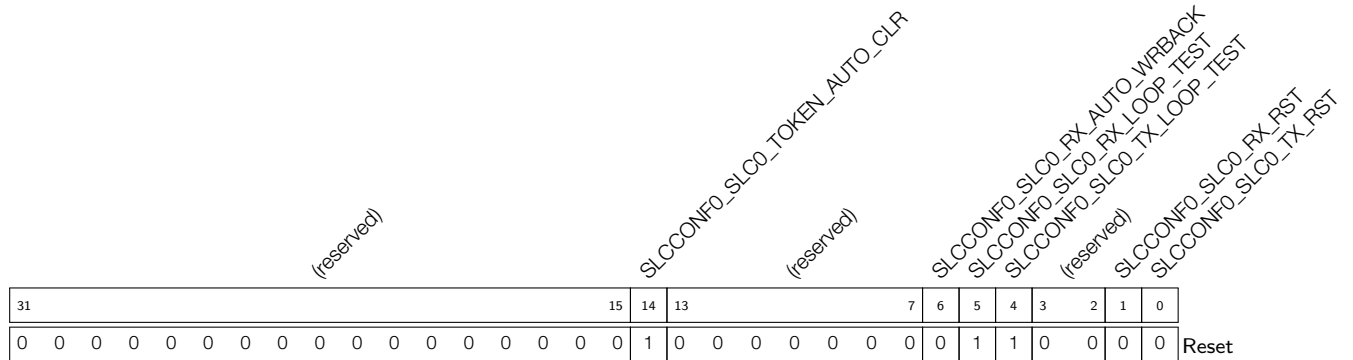
SLCHOST_CONF_W9_REG	Host and Slave communication register9	0x3FF550A0	R/W
SLCHOST_CONF_W10_REG	Host and Slave communication register10	0x3FF550A4	R/W
SLCHOST_CONF_W11_REG	Host and Slave communication register11	0x3FF550A8	R/W
SLCHOST_CONF_W12_REG	Host and Slave communication register12	0x3FF550AC	R/W
SLCHOST_CONF_W13_REG	Host and Slave communication register13	0x3FF550B0	R/W
SLCHOST_CONF_W14_REG	Host and Slave communication register14	0x3FF550B4	R/W
SLCHOST_CONF_W15_REG	Host and Slave communication register15	0x3FF550B8	R/W
SLCHOST_CONF_REG	Edge configuration	0x3FF551F0	R/W
<b>Interrupt Registers</b>			
SLC0HOST_INT_RAW_REG	Raw interrupt	0x3FF55000	RO
SLC0HOST_INT_ST_REG	Masked interrupt status	0x3FF55058	RO
SLC0HOST_INT_CLR_REG	Interrupt clear	0x3FF550D4	WO
SLC0HOST_FUNC1_INT_ENA_REG	Interrupt enable	0x3FF550DC	R/W

Name	Description	Address	Access
<b>SDIO HINF registers</b>			
HINF_CFG_DATA1_REG	SDIO specification configuration	0x3FF4B004	R/W

## 8.5 SLC Registers

The first block of SDIO control registers starts at 0x3FF5\_8000.

**Register 8.1. SLCCONF0\_REG (0x0)**



**SLCCONF0\_SLC0\_TOKEN\_AUTO\_CLR** Please initialize to 0. Do not modify it. (R/W)

**SLCCONF0\_SLC0\_RX\_AUTO\_WBACK** Allows changing the owner bit of the transmitting buffer's linked list when transmitting data. (R/W)

**SLCCONF0\_SLC0\_RX\_LOOP\_TEST** Loop around when the slave buffer finishes sending packets. When set to 1, hardware will not change the owner bit in the linked list. (R/W)

**SLCCONF0\_SLC0\_TX\_LOOP\_TEST** Loop around when the slave buffer finishes receiving packets. When set to 1, hardware will not change the owner bit in the linked list. (R/W)

**SLCCONF0\_SLC0\_RX\_RST** Set this bit to reset the transmitting FSM. (R/W)

**SLCCONF0\_SLC0\_TX\_RST** Set this bit to reset the receiving FSM. (R/W)



Register 8.2. SLC0INT\_RAW\_REG (0x4)

(reserved)			(reserved)				SLC0INT_SLC0_RX_DSCR_ERR_INT_RAW	SLC0INT_SLC0_TX_DSCR_ERR_INT_RAW	(reserved)			SLC0INT_SLC0_RX_EOF_INT_RAW	SLC0INT_SLC0_RX_DONE_INT_RAW	(reserved)			SLC0INT_SLC0_TX_SUC_EOF_INT_RAW	SLC0INT_SLC0_TX_DONE_INT_RAW	SLC0INT_SLC0_TX_OVF_INT_RAW	SLC0INT_SLC0_RX_UDF_INT_RAW	SLC0INT_SLC0_TX_START_INT_RAW	SLC0INT_SLC_FRHOST_INT_RAW	SLC0INT_SLC_FRHOST_BIT7_INT_RAW	SLC0INT_SLC_FRHOST_BIT6_INT_RAW	SLC0INT_SLC_FRHOST_BIT5_INT_RAW	SLC0INT_SLC_FRHOST_BIT4_INT_RAW	SLC0INT_SLC_FRHOST_BIT3_INT_RAW	SLC0INT_SLC_FRHOST_BIT2_INT_RAW	SLC0INT_SLC_FRHOST_BIT1_INT_RAW	SLC0INT_SLC_FRHOST_BIT0_INT_RAW	Reset
31	27	26	21	20	19	18	17	16	15	14	13	12	11	10	9	8	7	6	5	4	3	2	1	0							
0x00		0	0	0	0	0	0	0	0	0	0	0	0	0	0	0	0	0	0	0	0	0	0	0	0	0	0	0	0	0	

**SLC0INT\_SLC0\_RX\_DSCR\_ERR\_INT\_RAW** The raw interrupt bit for Slave sending descriptor error (RO)

**SLC0INT\_SLC0\_TX\_DSCR\_ERR\_INT\_RAW** The raw interrupt bit for Slave receiving descriptor error. (RO)

**SLC0INT\_SLC0\_RX\_EOF\_INT\_RAW** The interrupt mark bit for Slave sending operation finished. (RO)

**SLC0INT\_SLC0\_RX\_DONE\_INT\_RAW** The raw interrupt bit to mark single buffer as sent by Slave. (RO)

**SLC0INT\_SLC0\_TX\_SUC\_EOF\_INT\_RAW** The raw interrupt bit to mark Slave receiving operation as finished. (RO)

**SLC0INT\_SLC0\_TX\_DONE\_INT\_RAW** The raw interrupt bit to mark a single buffer as finished during Slave receiving operation. (RO)

**SLC0INT\_SLC0\_TX\_OVF\_INT\_RAW** The raw interrupt bit to mark Slave receiving buffer overflow. (RO)

**SLC0INT\_SLC0\_RX\_UDF\_INT\_RAW** The raw interrupt bit for Slave sending buffer underflow. (RO)

**SLC0INT\_SLC0\_TX\_START\_INT\_RAW** The raw interrupt bit for registering Slave receiving initialization interrupt. (RO)

**SLC0INT\_SLC0\_RX\_START\_INT\_RAW** The raw interrupt bit to mark Slave sending initialization interrupt. (RO)

**SLC0INT\_SLC\_FRHOST\_BIT7\_INT\_RAW** The interrupt mark bit 7 for Host to interrupt Slave. (RO)

**SLC0INT\_SLC\_FRHOST\_BIT6\_INT\_RAW** The interrupt mark bit 6 for Host to interrupt Slave. (RO)

**SLC0INT\_SLC\_FRHOST\_BIT5\_INT\_RAW** The interrupt mark bit 5 for Host to interrupt Slave. (RO)

**SLC0INT\_SLC\_FRHOST\_BIT4\_INT\_RAW** The interrupt mark bit 4 for Host to interrupt Slave. (RO)

**SLC0INT\_SLC\_FRHOST\_BIT3\_INT\_RAW** The interrupt mark bit 3 for Host to interrupt Slave. (RO)

**SLC0INT\_SLC\_FRHOST\_BIT2\_INT\_RAW** The interrupt mark bit 2 for Host to interrupt Slave. (RO)

**SLC0INT\_SLC\_FRHOST\_BIT1\_INT\_RAW** The interrupt mark bit 1 for Host to interrupt Slave. (RO)

**SLC0INT\_SLC\_FRHOST\_BIT0\_INT\_RAW** The interrupt mark bit 0 for Host to interrupt Slave. (RO)

**Register 8.3. SLC0INT\_ST\_REG (0x8)**

(reserved)			(reserved)			SLC0INT_SLC0_RX_DSCR_ERR_INT_ST	SLC0INT_SLC0_TX_DSCR_ERR_INT_ST	(reserved)	SLC0INT_SLC0_RX_EOF_INT_ST	SLC0INT_SLC0_RX_DONE_INT_ST	SLC0INT_SLC0_TX_SUC_EOF_INT_ST	(reserved)	SLC0INT_SLC0_TX_DONE_INT_ST	SLC0INT_SLC0_TX_OVF_INT_ST	SLC0INT_SLC0_RX_UDF_INT_ST	SLC0INT_SLC0_TX_START_INT_ST	SLC0INT_SLC_FRHOST_BIT7_INT_ST	SLC0INT_SLC_FRHOST_BIT6_INT_ST	SLC0INT_SLC_FRHOST_BIT5_INT_ST	SLC0INT_SLC_FRHOST_BIT4_INT_ST	SLC0INT_SLC_FRHOST_BIT3_INT_ST	SLC0INT_SLC_FRHOST_BIT2_INT_ST	SLC0INT_SLC_FRHOST_BIT1_INT_ST	SLC0INT_SLC_FRHOST_BIT0_INT_ST	Reset	
31	27	26	21	20	19	18	17	16	15	14	13	12	11	10	9	8	7	6	5	4	3	2	1	0		
0x00		0	0	0	0	0	0	0	0	0	0	0	0	0	0	0	0	0	0	0	0	0	0	0	0	

**SLC0INT\_SLC0\_RX\_DSCR\_ERR\_INT\_ST** The interrupt status bit for Slave sending descriptor error. (RO)

**SLC0INT\_SLC0\_TX\_DSCR\_ERR\_INT\_ST** The interrupt status bit for Slave receiving descriptor error. (RO)

**SLC0INT\_SLC0\_RX\_EOF\_INT\_ST** The interrupt status bit for finished Slave sending operation. (RO)

**SLC0INT\_SLC0\_RX\_DONE\_INT\_ST** The interrupt status bit for finished Slave sending operation. (RO)

**SLC0INT\_SLC0\_TX\_SUC\_EOF\_INT\_ST** The interrupt status bit for marking Slave receiving operation as finished. (RO)

**SLC0INT\_SLC0\_TX\_DONE\_INT\_ST** The interrupt status bit for marking a single buffer as finished during the receiving operation. (RO)

**SLC0INT\_SLC0\_TX\_OVF\_INT\_ST** The interrupt status bit for Slave receiving overflow interrupt. (RO)

**SLC0INT\_SLC0\_RX\_UDF\_INT\_ST** The interrupt status bit for Slave sending buffer underflow. (RO)

**SLC0INT\_SLC0\_TX\_START\_INT\_ST** The interrupt status bit for Slave receiving interrupt initialization. (RO)

**SLC0INT\_SLC0\_RX\_START\_INT\_ST** The interrupt status bit for Slave sending interrupt initialization. (RO)

**SLC0INT\_SLC\_FRHOST\_BIT7\_INT\_ST** The interrupt status bit 7 for Host to interrupt Slave. (RO)

**SLC0INT\_SLC\_FRHOST\_BIT6\_INT\_ST** The interrupt status bit 6 for Host to interrupt Slave. (RO)

**SLC0INT\_SLC\_FRHOST\_BIT5\_INT\_ST** The interrupt status bit 5 for Host to interrupt Slave. (RO)

**SLC0INT\_SLC\_FRHOST\_BIT4\_INT\_ST** The interrupt status bit 4 for Host to interrupt Slave. (RO)

**SLC0INT\_SLC\_FRHOST\_BIT3\_INT\_ST** The interrupt status bit 3 for Host to interrupt Slave. (RO)

**SLC0INT\_SLC\_FRHOST\_BIT2\_INT\_ST** The interrupt status bit 2 for Host to interrupt Slave. (RO)

**SLC0INT\_SLC\_FRHOST\_BIT1\_INT\_ST** The interrupt status bit 1 for Host to interrupt Slave. (RO)

**SLC0INT\_SLC\_FRHOST\_BIT0\_INT\_ST** The interrupt status bit 0 for Host to interrupt Slave. (RO)

## Register 8.4. SLC0INT\_ENA\_REG (0xC)

(reserved)		(reserved)		SLC0INT_SLC0_RX_DSCR_ERR_INT_ENA	SLC0INT_SLC0_TX_DSCR_ERR_INT_ENA	(reserved)	SLC0INT_SLC0_RX_EOF_INT_ENA	SLC0INT_SLC0_RX_DONE_INT_ENA	(reserved)	SLC0INT_SLC0_TX_SUC_EOF_INT_ENA	SLC0INT_SLC0_TX_DONE_INT_ENA	SLC0INT_SLC0_TX_OVF_INT_ENA	SLC0INT_SLC0_RX_UDF_INT_ENA	SLC0INT_SLC0_TX_START_INT_ENA	SLC0INT_SLC0_RX_START_INT_ENA	SLC0INT_SLC0_FRHOST_BIT7_INT_ENA	SLC0INT_SLC0_FRHOST_BIT6_INT_ENA	SLC0INT_SLC0_FRHOST_BIT5_INT_ENA	SLC0INT_SLC0_FRHOST_BIT4_INT_ENA	SLC0INT_SLC0_FRHOST_BIT3_INT_ENA	SLC0INT_SLC0_FRHOST_BIT2_INT_ENA	SLC0INT_SLC0_FRHOST_BIT1_INT_ENA	SLC0INT_SLC0_FRHOST_BIT0_INT_ENA	
31	27	26	21	20	19	18	17	16	15	14	13	12	11	10	9	8	7	6	5	4	3	2	1	0
0x00		0	0	0	0	0	0	0	0	0	0	0	0	0	0	0	0	0	0	0	0	0	0	0

Reset

**SLC0INT\_SLC0\_RX\_DSCR\_ERR\_INT\_ENA** The interrupt enable bit for Slave sending linked list descriptor error. (R/W)

**SLC0INT\_SLC0\_TX\_DSCR\_ERR\_INT\_ENA** The interrupt enable bit for Slave receiving linked list descriptor error. (R/W)

**SLC0INT\_SLC0\_RX\_EOF\_INT\_ENA** The interrupt enable bit for Slave sending operation completion. (R/W)

**SLC0INT\_SLC0\_RX\_DONE\_INT\_ENA** The interrupt enable bit for single buffer's sent interrupt, in Slave sending mode. (R/W)

**SLC0INT\_SLC0\_TX\_SUC\_EOF\_INT\_ENA** The interrupt enable bit for Slave receiving operation completion. (R/W)

**SLC0INT\_SLC0\_TX\_DONE\_INT\_ENA** The interrupt enable bit for single buffer's full event, in Slave receiving mode. (R/W)

**SLC0INT\_SLC0\_TX\_OVF\_INT\_ENA** The interrupt enable bit for Slave receiving buffer overflow. (R/W)

**SLC0INT\_SLC0\_RX\_UDF\_INT\_ENA** The interrupt enable bit for Slave sending buffer underflow. (R/W)

**SLC0INT\_SLC0\_TX\_START\_INT\_ENA** The interrupt enable bit for Slave receiving operation initialization. (R/W)

**SLC0INT\_SLC0\_RX\_START\_INT\_ENA** The interrupt enable bit for Slave sending operation initialization. (R/W)

**SLC0INT\_SLC\_FRHOST\_BIT7\_INT\_ENA** The interrupt enable bit 7 for Host to interrupt Slave. (R/W)

**SLC0INT\_SLC\_FRHOST\_BIT6\_INT\_ENA** The interrupt enable bit 6 for Host to interrupt Slave. (R/W)

**SLC0INT\_SLC\_FRHOST\_BIT5\_INT\_ENA** The interrupt enable bit 5 for Host to interrupt Slave. (R/W)

**SLC0INT\_SLC\_FRHOST\_BIT4\_INT\_ENA** The interrupt enable bit 4 for Host to interrupt Slave. (R/W)

**SLC0INT\_SLC\_FRHOST\_BIT3\_INT\_ENA** The interrupt enable bit 3 for Host to interrupt Slave. (R/W)

**SLC0INT\_SLC\_FRHOST\_BIT2\_INT\_ENA** The interrupt enable bit 2 for Host to interrupt Slave. (R/W)

**SLC0INT\_SLC\_FRHOST\_BIT1\_INT\_ENA** The interrupt enable bit 1 for Host to interrupt Slave. (R/W)

**SLC0INT\_SLC\_FRHOST\_BIT0\_INT\_ENA** The interrupt enable bit 0 for Host to interrupt Slave. (R/W)

## Register 8.5. SLC0INT\_CLR\_REG (0x10)

(reserved)		(reserved)				SLC0INT_SLC0_RX_DSCR_ERR_INT_CLR		SLC0INT_SLC0_TX_DSCR_ERR_INT_CLR		(reserved)		SLC0INT_SLC0_RX_EOF_INT_CLR		SLC0INT_SLC0_RX_DONE_INT_CLR		(reserved)		SLC0INT_SLC0_TX_SUC_EOF_INT_CLR		SLC0INT_SLC0_TX_DONE_INT_CLR		SLC0INT_SLC0_TX_OVF_INT_CLR		SLC0INT_SLC0_RX_UDF_INT_CLR		SLC0INT_SLC0_TX_START_INT_CLR		SLC0INT_SLC_FRHOST_INT_CLR		SLC0INT_SLC_FRHOST_BIT7_INT_CLR		SLC0INT_SLC_FRHOST_BIT6_INT_CLR		SLC0INT_SLC_FRHOST_BIT5_INT_CLR		SLC0INT_SLC_FRHOST_BIT4_INT_CLR		SLC0INT_SLC_FRHOST_BIT3_INT_CLR		SLC0INT_SLC_FRHOST_BIT2_INT_CLR		SLC0INT_SLC_FRHOST_BIT1_INT_CLR		SLC0INT_SLC_FRHOST_BIT0_INT_CLR	
31	27	26	25	24	23	22	21	20	19	18	17	16	15	14	13	12	11	10	9	8	7	6	5	4	3	2	1	0																	
0x00		0	0	0	0	0	0	0	0	0	0	0	0	0	0	0	0	0	0	0	0	0	0	0	0	0	0	0	0	0	0	0	0	0	0	0	0	0	0	0	0	Reset			

**SLC0INT\_SLC0\_RX\_DSCR\_ERR\_INT\_CLR** Interrupt clear bit for Slave sending linked list descriptor error. (WO)

**SLC0INT\_SLC0\_TX\_DSCR\_ERR\_INT\_CLR** Interrupt clear bit for Slave receiving linked list descriptor error. (WO)

**SLC0INT\_SLC0\_RX\_EOF\_INT\_CLR** Interrupt clear bit for Slave sending operation completion. (WO)

**SLC0INT\_SLC0\_RX\_DONE\_INT\_CLR** Interrupt clear bit for single buffer's sent interrupt, in Slave sending mode. (WO)

**SLC0INT\_SLC0\_TX\_SUC\_EOF\_INT\_CLR** Interrupt clear bit for Slave receiving operation completion. (WO)

**SLC0INT\_SLC0\_TX\_DONE\_INT\_CLR** Interrupt clear bit for single buffer's full event, in Slave receiving mode. (WO)

**SLC0INT\_SLC0\_TX\_OVF\_INT\_CLR** Set this bit to clear the Slave receiving overflow interrupt. (WO)

**SLC0INT\_SLC0\_RX\_UDF\_INT\_CLR** Set this bit to clear the Slave sending underflow interrupt. (WO)

**SLC0INT\_SLC0\_TX\_START\_INT\_CLR** Set this bit to clear the interrupt for Slave receiving operation initialization. (WO)

**SLC0INT\_SLC0\_RX\_START\_INT\_CLR** Set this bit to clear the interrupt for Slave sending operation initialization. (WO)

**SLC0INT\_SLC\_FRHOST\_BIT7\_INT\_CLR** Set this bit to clear the [SLC0INT\\_SLC\\_FRHOST\\_BIT7\\_INT](#) interrupt. (WO)

**SLC0INT\_SLC\_FRHOST\_BIT6\_INT\_CLR** Set this bit to clear the [SLC0INT\\_SLC\\_FRHOST\\_BIT6\\_INT](#) interrupt. (WO)

**SLC0INT\_SLC\_FRHOST\_BIT5\_INT\_CLR** Set this bit to clear the [SLC0INT\\_SLC\\_FRHOST\\_BIT5\\_INT](#) interrupt. (WO)

**SLC0INT\_SLC\_FRHOST\_BIT4\_INT\_CLR** Set this bit to clear the [SLC0INT\\_SLC\\_FRHOST\\_BIT4\\_INT](#) interrupt. (WO)

Continued on the next page...

## Register 8.5. SLC0INT\_CLR\_REG (0x10)

Continued from the previous page...

**SLC0INT\_SLC\_FRHOST\_BIT3\_INT\_CLR** Set this bit to clear **SLC0INT\_SLC\_FRHOST\_BIT3\_INT** interrupt. (WO)

**SLC0INT\_SLC\_FRHOST\_BIT2\_INT\_CLR** Set this bit to clear **SLC0INT\_SLC\_FRHOST\_BIT2\_INT** interrupt. (WO)

**SLC0INT\_SLC\_FRHOST\_BIT1\_INT\_CLR** Set this bit to clear **SLC0INT\_SLC\_FRHOST\_BIT1\_INT** interrupt. (WO)

**SLC0INT\_SLC\_FRHOST\_BIT0\_INT\_CLR** Set this bit to clear **SLC0INT\_SLC\_FRHOST\_BIT0\_INT** interrupt. (WO)

## Register 8.6. SLC0RX\_LINK\_REG (0x3C)

(reserved)				SLC0RX_SLC0_RXLINK_RESTART				(reserved)				SLC0RX_SLC0_RXLINK_ADDR																			
31	30	29	28	27	26	25	24	23	22	21	20	19	18	17	16	15	14	13	12	11	10	9	8	7	6	5	4	3	2	1	0
0	0	0	0	0	0	0	0	0	0	0	0	0	0x000000																		

Reset

**SLC0RX\_SLC0\_RXLINK\_RESTART** Set this bit to restart and continue the linked list operation for sending packets. (R/W)

**SLC0RX\_SLC0\_RXLINK\_START** Set this bit to start the linked list operation for sending packets. Sending will start from the address indicated by **SLC0\_RXLINK\_ADDR**. (R/W)

**SLC0RX\_SLC0\_RXLINK\_STOP** Set this bit to stop the linked list operation. (R/W)

**SLC0RX\_SLC0\_RXLINK\_ADDR** The lowest 20 bits in the initial address of Slave's sending linked list. (R/W)

## Register 8.7. SLC0TX\_LINK\_REG (0x40)

(reserved)				SLC0TX_SLC0_TXLINK_RESTART				(reserved)				SLC0TX_SLC0_TXLINK_ADDR				0
31	30	29	28	27					20	19					0	
0	0	0	0	0	0	0	0	0	0	0	0x000000				Reset	

**SLC0TX\_SLC0\_TXLINK\_RESTART** Set this bit to restart and continue the linked list operation for receiving packets. (R/W)

**SLC0TX\_SLC0\_TXLINK\_START** Set this bit to start the linked list operation for receiving packets. Receiving will start from the address indicated by SLC0\_TXLINK\_ADDR. (R/W)

**SLC0TX\_SLC0\_TXLINK\_STOP** Set this bit to stop the linked list operation for receiving packets. (R/W)

**SLC0TX\_SLC0\_TXLINK\_ADDR** The lowest 20 bits in the initial address of Slave's receiving linked list. (R/W)

## Register 8.8. SLCINTVEC\_TOHOST\_REG (0x4C)

(reserved)				(reserved)				(reserved)				SLCINTVEC_SLC0_TOHOST_INTVEC				0
31				24	23				16	15			8	7	0	
0x000				0 0 0 0 0 0 0 0				0x000				0x000				Reset

**SLCINTVEC\_SLC0\_TOHOST\_INTVEC** The interrupt vector for Slave to interrupt Host. (WO)

## Register 8.9. SLC0TOKEN1\_REG (0x54)

(reserved)				SLC0TOKEN1_SLC0_TOKEN1				(reserved)				SLC0TOKEN1_SLC0_TOKEN1_INC_MORE				(reserved)				SLC0TOKEN1_SLC0_TOKEN1_WDATA				
31	28	27					16	15	14	13	12	11												0
0x00				0x0000				0				0				0x0000				Reset				

**SLC0TOKEN1\_SLC0\_TOKEN1** The accumulated number of buffers for receiving packets. (RO)

**SLC0TOKEN1\_SLC0\_TOKEN1\_INC\_MORE** Set this bit to add the value of SLC0TOKEN1\_SLC0\_TOKEN1\_WDATA to that of SLC0TOKEN1\_SLC0\_TOKEN1. (WO)

**SLC0TOKEN1\_SLC0\_TOKEN1\_WDATA** The number of available receiving buffers. (WO)

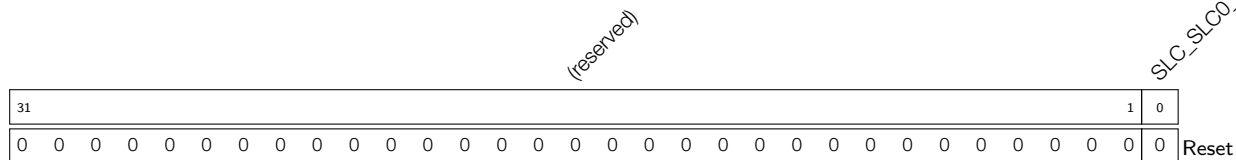
## Register 8.10. SLCCONF1\_REG (0x60)

(reserved)							(reserved)							(reserved)							SLCCONF1_SLC0_RX_STITCH_EN				SLCCONF1_SLC0_TX_STITCH_EN				SLCCONF1_SLC0_LEN_AUTO_CLR				
31						23	22								16	15											7	6	5	4			
0x000							0							0							0				0				1				Reset

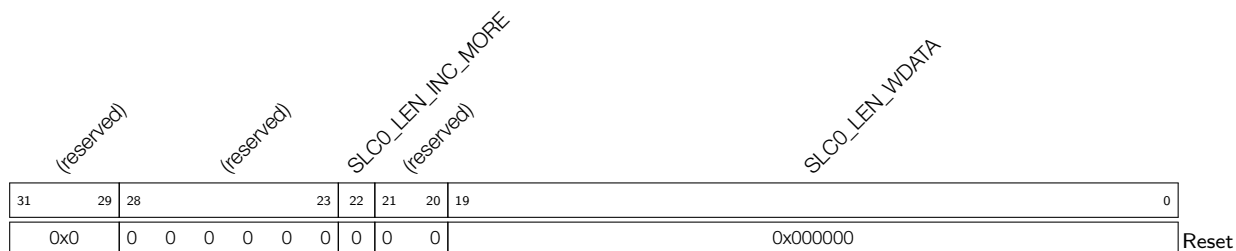
**SLCCONF1\_SLC0\_RX\_STITCH\_EN** Please initialize to 0. Do not modify it. (R/W)

**SLCCONF1\_SLC0\_TX\_STITCH\_EN** Please initialize to 0. Do not modify it. (R/W)

**SLCCONF1\_SLC0\_LEN\_AUTO\_CLR** Please initialize to 0. Do not modify it. (R/W)

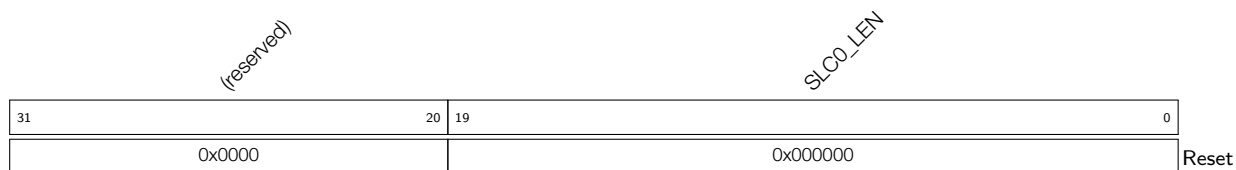
**Register 8.11. SLC\_RX\_DSCR\_CONF\_REG (0x98)**

**SLC\_SLC0\_TOKEN\_NO\_REPLACE** Please initialize to 1. Do not modify it. (R/W)

**Register 8.12. SLC0\_LEN\_CONF\_REG (0xE4)**

**SLC0\_LEN\_INC\_MORE** Set this bit to add the value of SLC0\_LEN to that of SLC0\_LEN\_WDATA. (WO)

**SLC0\_LEN\_WDATA** The packet length sent. (WO)

**Register 8.13. SLC0\_LENGTH\_REG (0xE8)**

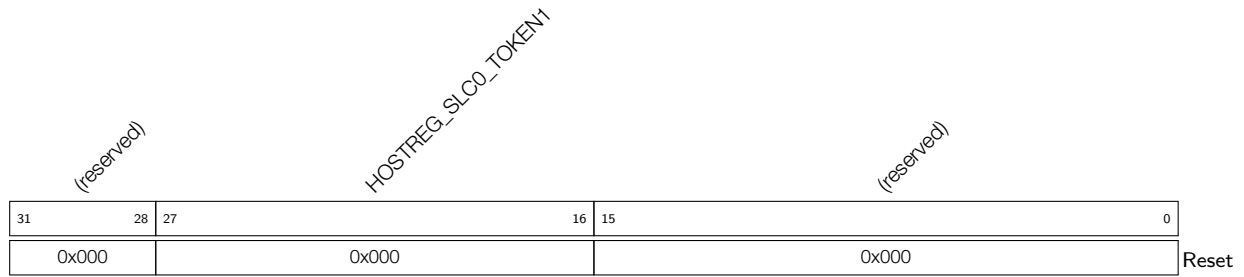
**SLC0\_LEN** Indicates the packet length sent by the Slave. (RO)

## 8.6 SLC Host Registers

The second block of SDIO control registers starts at 0x3FF5\_5000.



## Register 8.14. SLC0HOST\_TOKEN\_RDATA (0x44)



**HOSTREG\_SLC0\_TOKEN1** The accumulated number of Slave's receiving buffers. (RO)

Register 8.15. SLC0HOST\_INT\_RAW\_REG (0x50)

(reserved)		(reserved)		SLC0HOST_SLC0_RX_NEW_PACKET_INT_RAW				(reserved)				SLC0HOST_SLC0_TX_OVF_INT_RAW				(reserved)				SLC0HOST_SLC0_TOHOST_BIT7_INT_RAW		SLC0HOST_SLC0_TOHOST_BIT6_INT_RAW		SLC0HOST_SLC0_TOHOST_BIT5_INT_RAW		SLC0HOST_SLC0_TOHOST_BIT4_INT_RAW		SLC0HOST_SLC0_TOHOST_BIT3_INT_RAW		SLC0HOST_SLC0_TOHOST_BIT2_INT_RAW		SLC0HOST_SLC0_TOHOST_BIT1_INT_RAW		SLC0HOST_SLC0_TOHOST_BIT0_INT_RAW		
31	26	25	24	23	22	18	17	16	15	8	7	6	5	4	3	2	1	0																		
0x00		0	0	0	0	0	0	0	0	0	0	0	0	0	0	0	0	0	0	Reset																

**SLC0HOST\_SLC0\_RX\_NEW\_PACKET\_INT\_RAW** The raw interrupt status bit for the [SLC0HOST\\_SLC0\\_RX\\_NEW\\_PACKET\\_INT](#) interrupt. (RO)

**SLC0HOST\_SLC0\_TX\_OVF\_INT\_RAW** The raw interrupt status bit for the [SLC0HOST\\_SLC0\\_TX\\_OVF\\_INT](#) interrupt. (RO)

**SLC0HOST\_SLC0\_RX\_UDF\_INT\_RAW** The raw interrupt status bit for the [SLC0HOST\\_SLC0\\_RX\\_UDF\\_INT](#) interrupt. (RO)

**SLC0HOST\_SLC0\_TOHOST\_BIT7\_INT\_RAW** The raw interrupt status bit for the [SLC0HOST\\_SLC0\\_TOHOST\\_BIT7\\_INT](#) interrupt. (RO)

**SLC0HOST\_SLC0\_TOHOST\_BIT6\_INT\_RAW** The raw interrupt status bit for the [SLC0HOST\\_SLC0\\_TOHOST\\_BIT6\\_INT](#) interrupt. (RO)

**SLC0HOST\_SLC0\_TOHOST\_BIT5\_INT\_RAW** The raw interrupt status bit for the [SLC0HOST\\_SLC0\\_TOHOST\\_BIT5\\_INT](#) interrupt. (RO)

**SLC0HOST\_SLC0\_TOHOST\_BIT4\_INT\_RAW** The raw interrupt status bit for the [SLC0HOST\\_SLC0\\_TOHOST\\_BIT4\\_INT](#) interrupt. (RO)

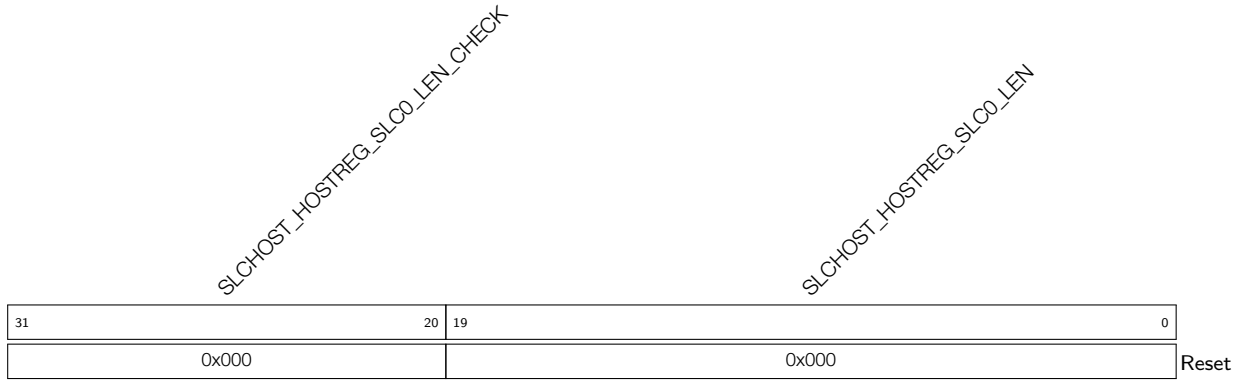
**SLC0HOST\_SLC0\_TOHOST\_BIT3\_INT\_RAW** The raw interrupt status bit for the [SLC0HOST\\_SLC0\\_TOHOST\\_BIT3\\_INT](#) interrupt. (RO)

**SLC0HOST\_SLC0\_TOHOST\_BIT2\_INT\_RAW** The raw interrupt status bit for the [SLC0HOST\\_SLC0\\_TOHOST\\_BIT2\\_INT](#) interrupt. (RO)

**SLC0HOST\_SLC0\_TOHOST\_BIT1\_INT\_RAW** The raw interrupt status bit for the [SLC0HOST\\_SLC0\\_TOHOST\\_BIT1\\_INT](#) interrupt. (RO)

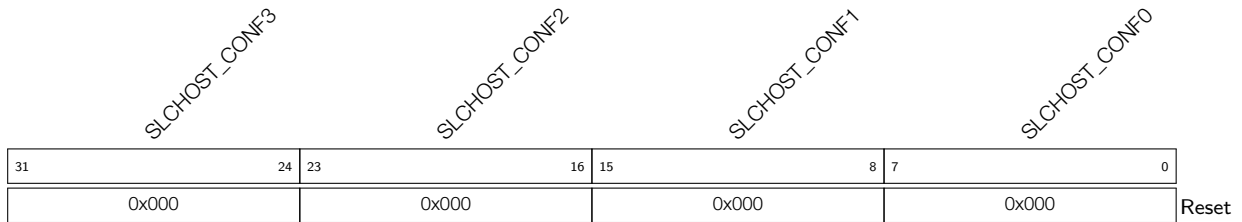
**SLC0HOST\_SLC0\_TOHOST\_BIT0\_INT\_RAW** The raw interrupt status bit for the [SLC0HOST\\_SLC0\\_TOHOST\\_BIT0\\_INT](#) interrupt. (RO)



**Register 8.17. SLCHOST\_PKT\_LEN\_REG (0x60)**

**SLCHOST\_HOSTREG\_SLC0\_LEN\_CHECK** Its value is HOSTREG\_SLC0\_LEN[9:0] plus HOSTREG\_SLC0\_LEN[19:10]. (RO)

**SLCHOST\_HOSTREG\_SLC0\_LEN** The accumulated value of the data length sent by the Slave. The value gets updated only when the Host reads it.

**Register 8.18. SLCHOST\_CONF\_W0\_REG (0x6C)**

**SLCHOST\_CONF3** The information interaction register between Host and Slave. Both Host and Slave can access it. (R/W)

**SLCHOST\_CONF2** The information interaction register between Host and Slave. Both Host and Slave can access it. (R/W)

**SLCHOST\_CONF1** The information interaction register between Host and Slave. Both Host and Slave can access it. (R/W)

**SLCHOST\_CONF0** The information interaction register between Host and Slave. Both Host and Slave can access it. (R/W)

**Register 8.19. SLCHOST\_CONF\_W1\_REG (0x70)**

<i>SLCHOST_CONF7</i>				<i>SLCHOST_CONF6</i>				<i>SLCHOST_CONF5</i>				<i>SLCHOST_CONF4</i>				
31	24	23	16	15	8	7	0	31	24	23	16	15	8	7	0	
0x000				0x000				0x000				0x000				Reset

**SLCHOST\_CONF7** The information interaction register between Host and Slave. Both Host and Slave can access it. (R/W)

**SLCHOST\_CONF6** The information interaction register between Host and Slave. Both Host and Slave can access it. (R/W)

**SLCHOST\_CONF5** The information interaction register between Host and Slave. Both Host and Slave can access it. (R/W)

**SLCHOST\_CONF4** The information interaction register between Host and Slave. Both Host and Slave can access it. (R/W)

**Register 8.20. SLCHOST\_CONF\_W2\_REG (0x74)**

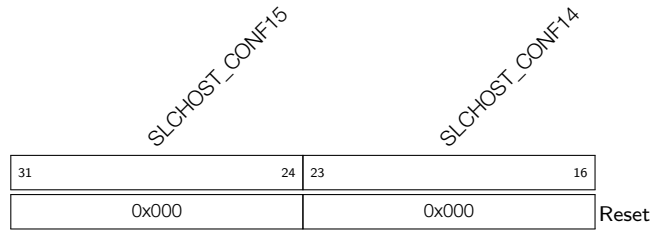
<i>SLCHOST_CONF11</i>				<i>SLCHOST_CONF10</i>				<i>SLCHOST_CONF9</i>				<i>SLCHOST_CONF8</i>				
31	24	23	16	15	8	7	0	31	24	23	16	15	8	7	0	
0x000				0x000				0x000				0x000				Reset

**SLCHOST\_CONF11** The information interaction register between Host and Slave. Both Host and Slave can access it. (R/W)

**SLCHOST\_CONF10** The information interaction register between Host and Slave. Both Host and Slave can access it. (R/W)

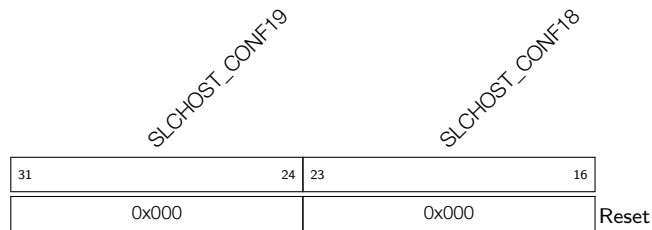
**SLCHOST\_CONF9** The information interaction register between Host and Slave. Both Host and Slave can access it. (R/W)

**SLCHOST\_CONF8** The information interaction register between Host and Slave. Both Host and Slave can access it. (R/W)

**Register 8.21. SLCHOST\_CONF\_W3\_REG (0x78)**

**SLCHOST\_CONF15** The information interaction register between Host and Slave. Both Host and Slave can be read from and written to this. (R/W)

**SLCHOST\_CONF14** The information interaction register between Host and Slave. Both Host and Slave can be read from and written to this. (R/W)

**Register 8.22. SLCHOST\_CONF\_W4\_REG (0x7C)**

**SLCHOST\_CONF19** The information interaction register between Host and Slave. Both Host and Slave can access it. (R/W)

**SLCHOST\_CONF18** The information interaction register between Host and Slave. Both Host and Slave can access it. (R/W)

**Register 8.23. SLCHOST\_CONF\_W6\_REG (0x88)**

<i>SLCHOST_CONF27</i>								<i>SLCHOST_CONF26</i>								<i>SLCHOST_CONF25</i>								<i>SLCHOST_CONF24</i>											
31								24	23								16	15								8	7								0
0x000								0x000								0x000								0x000								Reset			

**SLCHOST\_CONF27** The information interaction register between Host and Slave. Both Host and Slave can access it. (R/W)

**SLCHOST\_CONF26** The information interaction register between Host and Slave. Both Host and Slave can access it. (R/W)

**SLCHOST\_CONF25** The information interaction register between Host and Slave. Both Host and Slave can access it. (R/W)

**SLCHOST\_CONF24** The information interaction register between Host and Slave. Both Host and Slave can access it. (R/W)

**Register 8.24. SLCHOST\_CONF\_W7\_REG (0x8C)**

<i>SLCHOST_CONF31</i>								<i>(reserved)</i>								<i>SLCHOST_CONF29</i>								<i>(reserved)</i>											
31								24	23								16	15								8	7								0
0 0 0 0 0 0 0 0								0x000								0 0 0 0 0 0 0 0								0x000								Reset			

**SLCHOST\_CONF31** The interrupt vector used by Host to interrupt Slave. This bit will not be cleared automatically. (WO)

**SLCHOST\_CONF29** The interrupt vector used by Host to interrupt Slave. This bit will not be cleared automatically. (WO)

**Register 8.25. SLCHOST\_CONF\_W8\_REG (0x9C)**

<i>SLCHOST_CONF35</i>				<i>SLCHOST_CONF34</i>				<i>SLCHOST_CONF33</i>				<i>SLCHOST_CONF32</i>				
31	24	23	16	15	8	7	0									
0x000				0x000				0x000				0x000				Reset

**SLCHOST\_CONF35** The information interaction register between Host and Slave. Both Host and Slave can access it. (R/W)

**SLCHOST\_CONF34** The information interaction register between Host and Slave. Both Host and Slave can access it. (R/W)

**SLCHOST\_CONF33** The information interaction register between Host and Slave. Both Host and Slave can access it. (R/W)

**SLCHOST\_CONF32** The information interaction register between Host and Slave. Both Host and Slave can access it. (R/W)

**Register 8.26. SLCHOST\_CONF\_W9\_REG (0xA0)**

<i>SLCHOST_CONF39</i>				<i>SLCHOST_CONF38</i>				<i>SLCHOST_CONF37</i>				<i>SLCHOST_CONF36</i>				
31	24	23	16	15	8	7	0									
0x000				0x000				0x000				0x000				Reset

**SLCHOST\_CONF39** The information interaction register between Host and Slave. Both Host and Slave can access it. (R/W)

**SLCHOST\_CONF38** The information interaction register between Host and Slave. Both Host and Slave can access it. (R/W)

**SLCHOST\_CONF37** The information interaction register between Host and Slave. Both Host and Slave can access it. (R/W)

**SLCHOST\_CONF36** The information interaction register between Host and Slave. Both Host and Slave can access it. (R/W)



**Register 8.27. SLCHOST\_CONF\_W10\_REG (0xA4)**

<i>SLCHOST_CONF43</i>				<i>SLCHOST_CONF42</i>				<i>SLCHOST_CONF41</i>				<i>SLCHOST_CONF40</i>				
31	24	23	16	15	8	7	0									
0x000				0x000				0x000				0x000				Reset

**SLCHOST\_CONF43** The information interaction register between Host and Slave. Both Host and Slave can access it. (R/W)

**SLCHOST\_CONF42** The information interaction register between Host and Slave. Both Host and Slave can access it. (R/W)

**SLCHOST\_CONF41** The information interaction register between Host and Slave. Both Host and Slave can access it. (R/W)

**SLCHOST\_CONF40** The information interaction register between Host and Slave. Both Host and Slave can access it. (R/W)

**Register 8.28. SLCHOST\_CONF\_W11\_REG (0xA8)**

<i>SLCHOST_CONF47</i>				<i>SLCHOST_CONF46</i>				<i>SLCHOST_CONF45</i>				<i>SLCHOST_CONF44</i>				
31	24	23	16	15	8	7	0									
0x000				0x000				0x000				0x000				Reset

**SLCHOST\_CONF47** The information interaction register between Host and Slave. Both Host and Slave can access it. (R/W)

**SLCHOST\_CONF46** The information interaction register between Host and Slave. Both Host and Slave can access it. (R/W)

**SLCHOST\_CONF45** The information interaction register between Host and Slave. Both Host and Slave can access it. (R/W)

**SLCHOST\_CONF44** The information interaction register between Host and Slave. Both Host and Slave can access it. (R/W)

**Register 8.29. SLCHOST\_CONF\_W12\_REG (0xAC)**

<i>SLCHOST_CONF51</i>				<i>SLCHOST_CONF50</i>				<i>SLCHOST_CONF49</i>				<i>SLCHOST_CONF48</i>				
31	24	23	16	15	8	7	0									
0x000				0x000				0x000				0x000				Reset

**SLCHOST\_CONF51** The information interaction register between Host and Slave. Both Host and Slave can access it. (R/W)

**SLCHOST\_CONF50** The information interaction register between Host and Slave. Both Host and Slave can access it. (R/W)

**SLCHOST\_CONF49** The information interaction register between Host and Slave. Both Host and Slave can access it. (R/W)

**SLCHOST\_CONF48** The information interaction register between Host and Slave. Both Host and Slave can access it. (R/W)

**Register 8.30. SLCHOST\_CONF\_W13\_REG (0xB0)**

<i>SLCHOST_CONF55</i>				<i>SLCHOST_CONF54</i>				<i>SLCHOST_CONF53</i>				<i>SLCHOST_CONF52</i>				
31	24	23	16	15	8	7	0									
0x000				0x000				0x000				0x000				Reset

**SLCHOST\_CONF55** The information interaction register between Host and Slave. Both Host and Slave can access it. (R/W)

**SLCHOST\_CONF54** The information interaction register between Host and Slave. Both Host and Slave can access it. (R/W)

**SLCHOST\_CONF53** The information interaction register between Host and Slave. Both Host and Slave can access it. (R/W)

**SLCHOST\_CONF52** The information interaction register between Host and Slave. Both Host and Slave can access it. (R/W)

**Register 8.31. SLCHOST\_CONF\_W14\_REG (0xB4)**

<i>SLCHOST_CONF59</i>				<i>SLCHOST_CONF58</i>				<i>SLCHOST_CONF57</i>				<i>SLCHOST_CONF56</i>				
31	24	23	16	15	8	7	0									
0x000				0x000				0x000				0x000				Reset

**SLCHOST\_CONF59** The information interaction register between Host and Slave. Both Host and Slave can access it. (R/W)

**SLCHOST\_CONF58** The information interaction register between Host and Slave. Both Host and Slave can access it. (R/W)

**SLCHOST\_CONF57** The information interaction register between Host and Slave. Both Host and Slave can access it. (R/W)

**SLCHOST\_CONF56** The information interaction register between Host and Slave. Both Host and Slave can access it. (R/W)

**Register 8.32. SLCHOST\_CONF\_W15\_REG (0xB8)**

<i>SLCHOST_CONF63</i>				<i>SLCHOST_CONF62</i>				<i>SLCHOST_CONF61</i>				<i>SLCHOST_CONF60</i>				
31	24	23	16	15	8	7	0									
0x000				0x000				0x000				0x000				Reset

**SLCHOST\_CONF63** The information interaction register between Host and Slave. Both Host and Slave can access it. (R/W)

**SLCHOST\_CONF62** The information interaction register between Host and Slave. Both Host and Slave can access it. (R/W)

**SLCHOST\_CONF61** The information interaction register between Host and Slave. Both Host and Slave can access it. (R/W)

**SLCHOST\_CONF60** The information interaction register between Host and Slave. Both Host and Slave can access it. (R/W)

Register 8.33. SLC0HOST\_INT\_CLR\_REG (0xD4)

(reserved)	(reserved)	SLC0HOST_SLC0_RX_NEW_PACKET_INT_CLR	(reserved)	SLC0HOST_SLC0_TX_OVF_INT_CLR	SLC0HOST_SLC0_RX_UDF_INT_CLR	(reserved)	SLC0HOST_SLC0_TOHOST_BIT7_INT_CLR	SLC0HOST_SLC0_TOHOST_BIT6_INT_CLR	SLC0HOST_SLC0_TOHOST_BIT5_INT_CLR	SLC0HOST_SLC0_TOHOST_BIT4_INT_CLR	SLC0HOST_SLC0_TOHOST_BIT3_INT_CLR	SLC0HOST_SLC0_TOHOST_BIT2_INT_CLR	SLC0HOST_SLC0_TOHOST_BIT1_INT_CLR	SLC0HOST_SLC0_TOHOST_BIT0_INT_CLR	Reset				
31	26	25	24	23	22	18	17	16	15	8	7	6	5	4	3	2	1	0	
0x00	0	0	0	0	0	0	0	0	0	0	0	0	0	0	0	0	0	0	0

**SLC0HOST\_SLC0\_RX\_NEW\_PACKET\_INT\_CLR** Set this bit to clear the [SLC0HOST\\_SLC0\\_RX\\_NEW\\_PACKET\\_INT](#) interrupt. (WO)

**SLC0HOST\_SLC0\_TX\_OVF\_INT\_CLR** Set this bit to clear the [SLC0HOST\\_SLC0\\_TX\\_OVF\\_INT](#) interrupt. (WO)

**SLC0HOST\_SLC0\_RX\_UDF\_INT\_CLR** Set this bit to clear the [SLC0HOST\\_SLC0\\_RX\\_UDF\\_INT](#) interrupt. (WO)

**SLC0HOST\_SLC0\_TOHOST\_BIT7\_INT\_CLR** Set this bit to clear the [SLC0HOST\\_SLC0\\_TOHOST\\_BIT7\\_INT](#) interrupt. (WO)

**SLC0HOST\_SLC0\_TOHOST\_BIT6\_INT\_CLR** Set this bit to clear the [SLC0HOST\\_SLC0\\_TOHOST\\_BIT6\\_INT](#) interrupt. (WO)

**SLC0HOST\_SLC0\_TOHOST\_BIT5\_INT\_CLR** Set this bit to clear the [SLC0HOST\\_SLC0\\_TOHOST\\_BIT5\\_INT](#) interrupt. (WO)

**SLC0HOST\_SLC0\_TOHOST\_BIT4\_INT\_CLR** Set this bit to clear the [SLC0HOST\\_SLC0\\_TOHOST\\_BIT4\\_INT](#) interrupt. (WO)

**SLC0HOST\_SLC0\_TOHOST\_BIT3\_INT\_CLR** Set this bit to clear the [SLC0HOST\\_SLC0\\_TOHOST\\_BIT3\\_INT](#) interrupt. (WO)

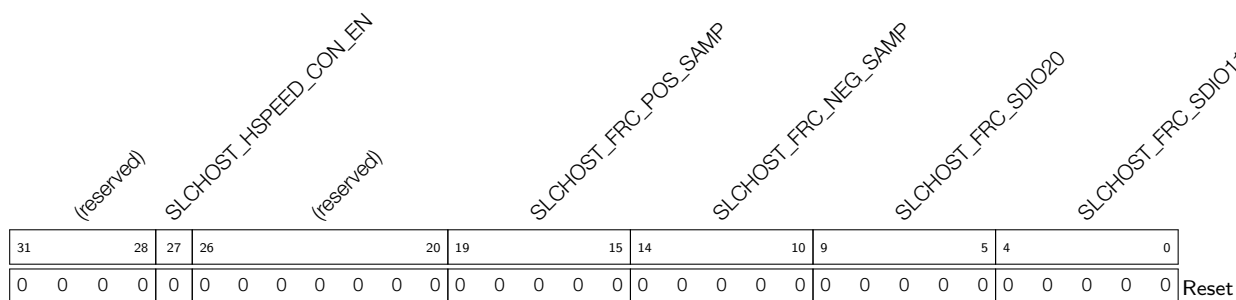
**SLC0HOST\_SLC0\_TOHOST\_BIT2\_INT\_CLR** Set this bit to clear the [SLC0HOST\\_SLC0\\_TOHOST\\_BIT2\\_INT](#) interrupt. (WO)

**SLC0HOST\_SLC0\_TOHOST\_BIT1\_INT\_CLR** Set this bit to clear the [SLC0HOST\\_SLC0\\_TOHOST\\_BIT1\\_INT](#) interrupt. (WO)

**SLC0HOST\_SLC0\_TOHOST\_BIT0\_INT\_CLR** Set this bit to clear the [SLC0HOST\\_SLC0\\_TOHOST\\_BIT0\\_INT](#) interrupt. (WO)



**Register 8.35. SLCHOST\_CONF\_REG (0x1F0)**



**SLCHOST\_HSPEED\_CON\_EN** Set this bit and HINF\_HIGH\_SPEED\_ENABLE, then set the EHS (Enable High-Speed) bit in CCCR at the Host side to output the corresponding signal at the rising clock edge. (R/W)

**SLCHOST\_FRC\_POS\_SAMP** Set this bit to sample the corresponding signal at the rising clock edge. (R/W)

**SLCHOST\_FRC\_NEG\_SAMP** Set this bit to sample the corresponding signal at the falling clock edge. (R/W)

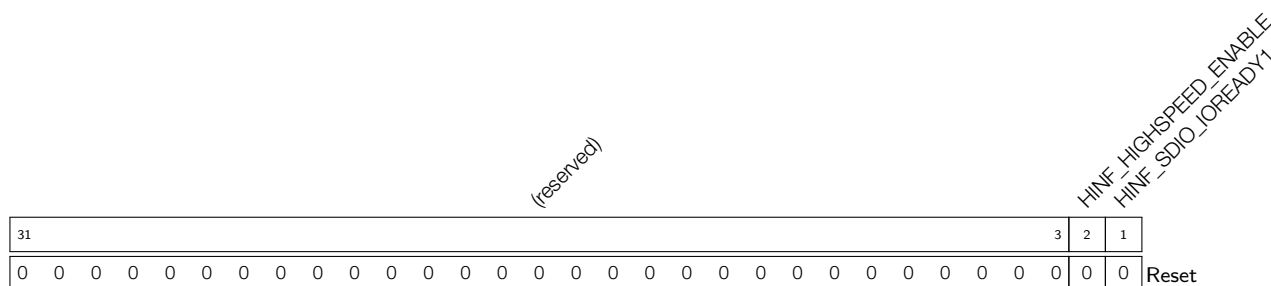
**SLCHOST\_FRC\_SDIO20** Set this bit to output the corresponding signal at the rising clock edge. (R/W)

**SLCHOST\_FRC\_SDIO11** Set this bit to output the corresponding signal at the falling clock edge. (R/W)

## 8.7 HINF Registers

The third block of SDIO control registers starts at 0x3FF4\_B000.

**Register 8.36. HINF\_CFG\_DATA1\_REG (0x4)**



**HINF\_HIGH\_SPEED\_ENABLE** Please initialize to 1. Do not modify it. (R/W)

**HINF\_SDIO\_IOREADY1** Please initialize to 1. Do not modify it. (R/W)

## 9 SD/MMC Host Controller

### 9.1 Overview

The ESP32 memory card interface controller provides a hardware interface between the Advanced Peripheral Bus (APB) and an external memory device. The memory card interface allows the ESP32 to be connected to SDIO memory cards, MMC cards and devices with a CE-ATA interface. It supports two external cards (Card0 and Card1).

### 9.2 Features

This module has the following features:

- Two external cards
- Supports SD Memory Card standard: versions 3.0 and 3.01
- Supports MMC: versions 4.41, 4.5, and 4.51
- Supports CE-ATA: version 1.1
- Supports 1-bit, 4-bit, and 8-bit (Card0 only) modes

The SD/MMC controller topology is shown in Figure 9-1. The controller supports two peripherals which cannot be functional at the same time.

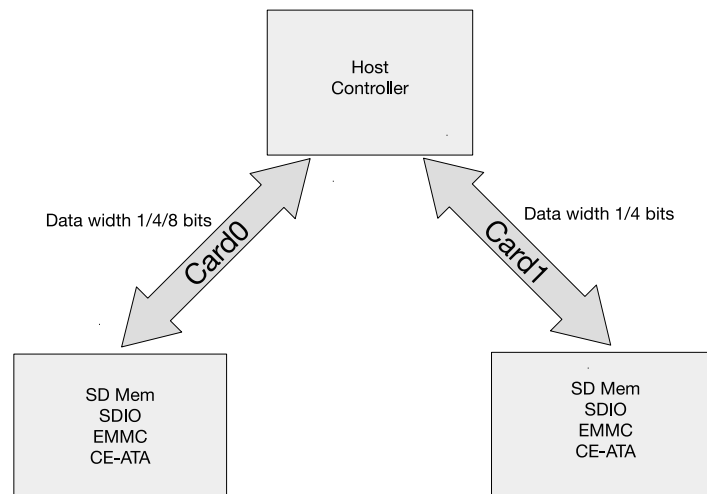


Figure 9-1. SD/MMC Controller Topology

### 9.3 SD/MMC External Interface Signals

The primary external interface signals, which enable the SD/MMC controller to communicate with an external device, are clock (clk), command (cmd) and data signals. Additional signals include the card interrupt, card detect, and write-protect signals. The direction of each signal is shown in Figure 9-2. The direction and description of each pin are listed in Table 9-1.

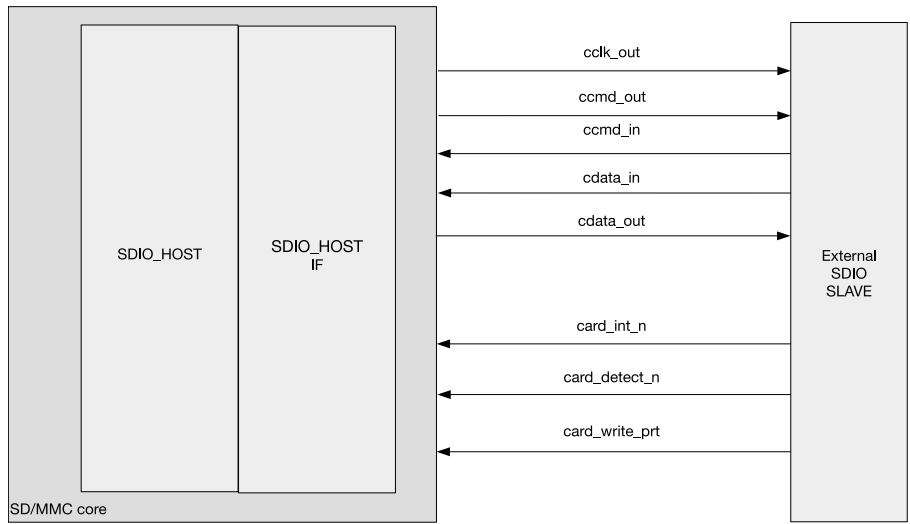


Figure 9-2. SD/MMC Controller External Interface Signals

Table 9-1. SD/MMC Signal Description

Pin	Direction	Description
cclk_out	Output	Clock signals for slave device
ccmd	Duplex	Duplex command/response lines
cdata	Duplex	Duplex data read/write lines
card_detect_n	Input	Card detection input line
card_write_prt	Input	Card write protection status input

## 9.4 Functional Description

### 9.4.1 SD/MMC Host Controller Architecture

The SD/MMC host controller consists of two main functional blocks, as shown in Figure 9-3:

- Bus Interface Unit (BIU): It provides APB interfaces for registers, data read and write operation by FIFO and DMA.
- Card Interface Unit (CIU): It handles external memory card interface protocols. It also provides clock control.

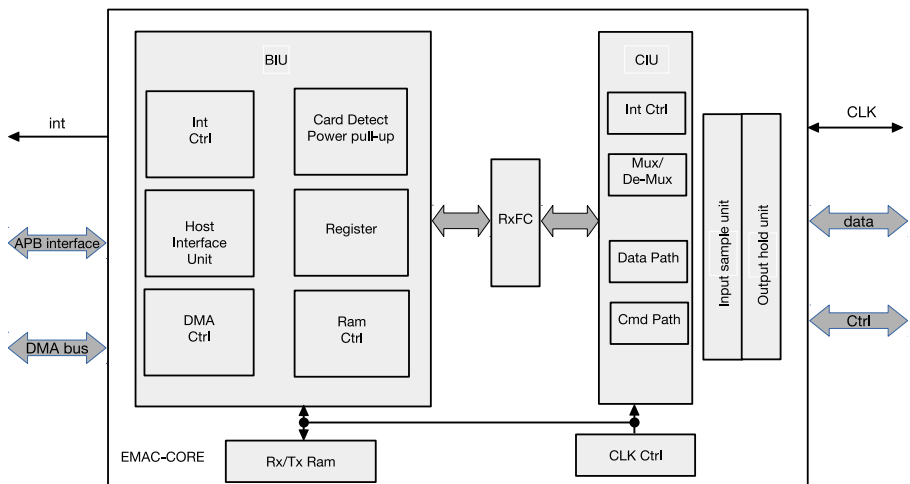


Figure 9-3. SDIO Host Block Diagram



### 9.4.1.1 BIU

The BIU provides the access to registers and FIFO data through the Host Interface Unit (HIU). Additionally, it provides FIFO access to independent data through a DMA interface. The host interface can be configured as an APB interface. Figure 9-3 illustrates the internal components of the BIU. The BIU provides the following functions:

- Host interface
- DMA interface
- Interrupt control
- Register access
- FIFO access
- Power/pull-up control and card detection

### 9.4.1.2 CIU

The CIU module implements the card-specific protocols. Within the CIU, the command path control unit and data path control unit prompt the controller to interface with the command and data ports, respectively, of the SD/MMC/CE-ATA cards. The CIU also provides clock control. Figure 9-3 illustrates the internal structure of the CIU, which consists of the following primary functional blocks:

- Command path
- Data path
- SDIO interrupt control
- Clock control
- Mux/demux unit

## 9.4.2 Command Path

The command path performs the following functions:

- Configures clock parameters
- Configures card command parameters
- Sends commands to card bus (ccmd\_out line)
- Receives responses from card bus (ccmd\_in line)
- Sends responses to BIU
- Drives the P-bit on the command line

The command path State Machine is shown in Figure 9-4.

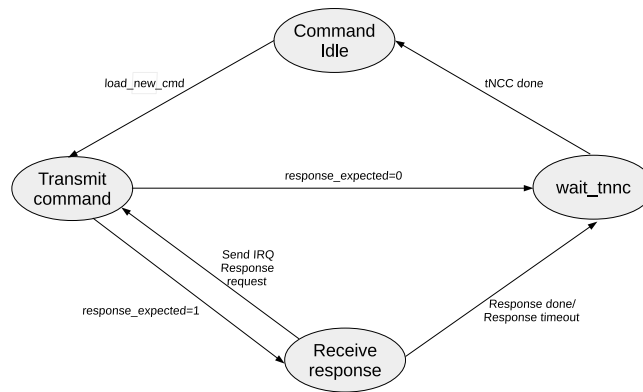


Figure 9-4. Command Path State Machine

### 9.4.3 Data Path

The data path block pops FIFO data and transmits them on `cdata_out` during a write-data transfer, or it receives data on `cdata_in` and pushes them into FIFO during a read-data transfer. The data path loads new data parameters, i.e., expected data, read/write data transfer, stream/block transfer, block size, byte count, card type, timeout registers, etc., whenever a data transfer command is not in progress.

If the `data_expected` bit is set in the Command register, the new command is a data-transfer command and the data path starts one of the following operations:

- Transmitting data if the read/write bit = 1
- Receiving data if read/write bit = 0

#### 9.4.3.1 Data Transmit Operation

The data transmit state machine is illustrated in Figure 9-5. The module starts data transmission two clock cycles after a response for the data-write command is received. This occurs even if the command path detects a response error or a cyclic redundancy check (CRC) error in a response. If no response is received from the card until the response timeout, no data are transmitted. Depending on the value of the `transfer_mode` bit in the Command register, the data-transmit state machine adds data to the card's data bus in a stream or in block(s). The data transmit state machine is shown in Figure 9-5.

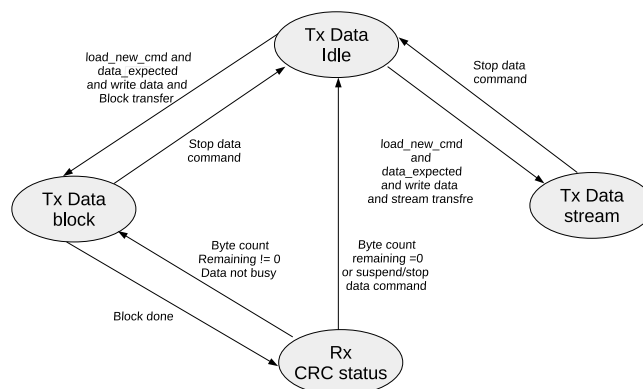


Figure 9-5. Data Transmit State Machine

### 9.4.3.2 Data Receive Operation

The data-receive state machine is illustrated in Figure 9-6. The module receives data two clock cycles after the end bit of a data-read command, even if the command path detects a response error or a CRC error. If no response is received from the card and a response timeout occurs, the BIU does not receive a signal about the completion of the data transfer. If the command sent by the CIU is an illegal operation for the card, it would prevent the card from starting a read-data transfer, and the BIU will not receive a signal about the completion of the data transfer.

If no data are received by the data timeout, the data path signals a data timeout to the BIU, which marks an end to the data transfer. Based on the value of the transfer\_mode bit in the Command register, the data-receive state machine gets data from the card's data bus in a stream or block(s). The data receive state machine is shown in Figure 9-6.

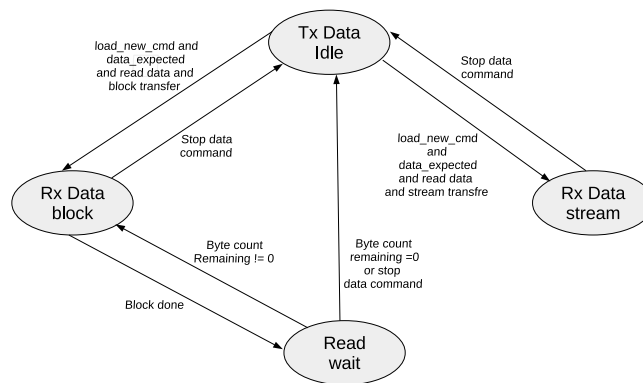


Figure 9-6. Data Receive State Machine

## 9.5 Software Restrictions for Proper CIU Operation

- Only one card at a time can be selected to execute a command or data transfer. For example, when data are being transferred to or from a card, a new command must not be issued to another card. A new command, however, can be issued to the same card, allowing it to read the device status or stop the transfer.
- Only one command at a time can be issued for data transfers.
- During an open-ended card-write operation, if the card clock is stopped due to FIFO being empty, the software must fill FIFO with data first, and then start the card clock. Only then can it issue a stop/abort command to the card.
- During an SDIO/COMBO card transfer, if the card function is suspended and the software wants to resume the suspended transfer, it must first reset FIFO, and then issue the resume command as if it were a new data-transfer command.
- When issuing card reset commands (CMD0, CMD15 or CMD52\_reset), while a card data transfer is in progress, the software must set the stop\_abort\_cmd bit in the Command register, so that the CIU can stop the data transfer after issuing the card reset command.
- When the data's end bit error is set in the RINTSTS register, the CIU does not guarantee SDIO interrupts. In such a case, the software ignores SDIO interrupts and issues a stop/abort command to the card, so that the card stops sending read-data.
- If the card clock is stopped due to FIFO being full during a card read, the software will read at least two FIFO locations to restart the card clock.

- Only one CE-ATA device at a time can be selected for a command or data transfer. For example, when data are transferred from a CE-ATA device, a new command should not be sent to another CE-ATA device.
- If a CE-ATA device's interrupts are enabled ( $nIEN=0$ ), a new RW\_BLK command should not be sent to the same device if the execution of a RW\_BLK command is already in progress (the RW\_BLK command used in this databook is the RW\_MULTIPLE\_BLOCK MMC command defined by the CE-ATA specifications). Only the CCSD can be sent while waiting for the CCS.
- If, however, a CE-ATA device's interrupts are disabled ( $nIEN=1$ ), a new command can be issued to the same device, allowing it to read status information.
- Open-ended transfers are not supported in CE-ATA devices.
- The send\_auto\_stop signal is not supported (software should not set the send\_auto\_stop bit) in CE-ATA transfers.

After configuring the command start bit to 1, the values of the following registers cannot be changed before a command has been issued:

- CMD - command
- CMDARG - command argument
- BYTCNT - byte count
- BLKSIZ - block size
- CLKDIV - clock divider
- CKLENA - clock enable
- CLKSRC - clock source
- TMOUT - timeout
- CTYPE - card type

## 9.6 RAM for Receiving and Sending Data

The submodule RAM is a buffer area for sending and receiving data. It can be divided into two units: the one is for sending data, and the other is for receiving data. The process of sending and receiving data can also be achieved by the CPU and DMA for reading and writing. The latter method is described in detail in Section 9.8.

### 9.6.1 Transmit RAM Module

There are two ways to enable a write operation: DMA and CPU read/write.

If SDIO-sending is enabled, data can be written to the transferred RAM module by APB interface or DMA. Data will be written from register EMAC\_FIFO to the CPU, directly, by an APB interface.

### 9.6.2 Receive RAM Module

There are two ways to enable a read operation: DMA and CPU read/write.

When a subunit of the data path receives data, the subdata will be written onto the receive-RAM. Then, these subdata can be read either with the APB or the DMA method at the reading end. Register EMAC\_FIFO can be read by the APB directly.

### 9.7 Descriptor Chain

Each linked list module consists of two parts: the linked list itself and a data buffer. In other words, each module points to a unique data buffer and the linked list that follows the module. Figure 9-7 shows the descriptor chain.

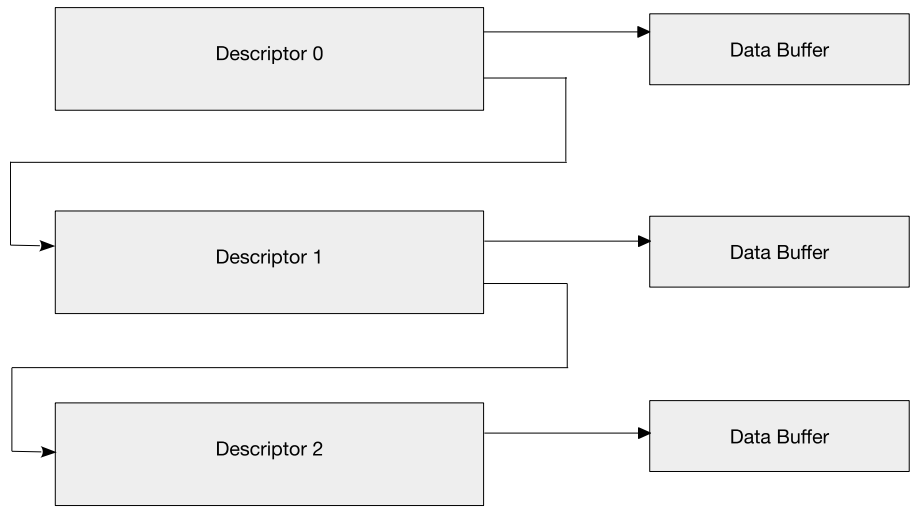


Figure 9-7. Descriptor Chain

### 9.8 The Structure of a Linked List

Each linked list consists of four words. As is shown below, Figure 9-8 demonstrates the linked list's structure, and Table 9-2, Table 9-3, Table 9-4, Table 9-5 provide the descriptions of linked lists.

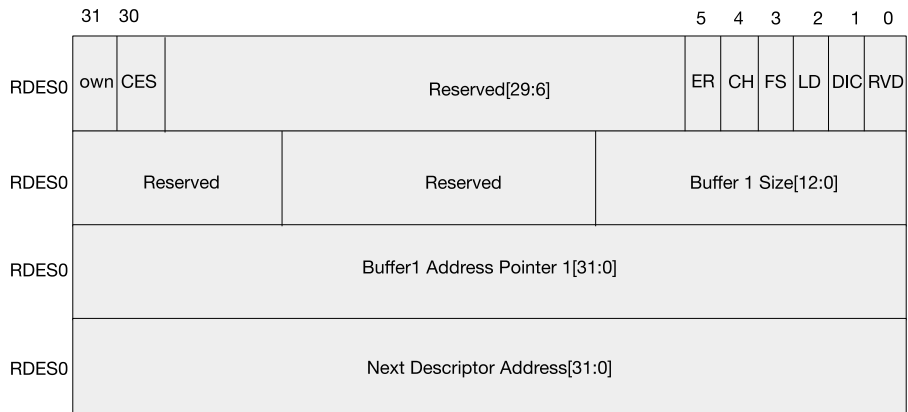


Figure 9-8. The Structure of a Linked List

The DES0 element contains control and status information.

Table 9-2. DES0

Bits	Name	Description
31	OWN	When set, this bit indicates that the descriptor is owned by the DMAC. When reset, it indicates that the descriptor is owned by the Host. The DMAC clears this bit when it completes the data transfer.

Bits	Name	Description
30	CES (Card Error Summary)	<p>These error bits indicate the status of the transition to or from the card.</p> <p>The following bits are also present in RINTSTS, which indicates their digital logic OR gate.</p> <ul style="list-style-type: none"> <li>• EBE: End Bit Error</li> <li>• RTO: Response Time out</li> <li>• RCRC: Response CRC</li> <li>• SBE: Start Bit Error</li> <li>• DRTO: Data Read Timeout</li> <li>• DCRC: Data CRC for Receive</li> <li>• RE: Response Error</li> </ul>
29:6	Reserved	Reserved
5	ER (End of Ring)	When set, this bit indicates that the descriptor list has reached its final descriptor. The DMAC then returns to the base address of the list, creating a Descriptor Ring.
4	CH (Second Address Chained)	When set, this bit indicates that the second address in the descriptor is the Next Descriptor address. When this bit is set, BS2 (DES1[25:13]) should be all zeros.
3	FD (First Descriptor)	When set, this bit indicates that this descriptor contains the first buffer of the data. If the size of the first buffer is 0, the Next Descriptor contains the beginning of the data.
2	LD (Last Descriptor)	This bit is associated with the last block of a DMA transfer. When set, the bit indicates that the buffers pointed by this descriptor are the last buffers of the data. After this descriptor is completed, the remaining byte count is 0. In other words, after the descriptor with the LD bit set is completed, the remaining byte count should be 0.
1	DIC (Disable Interrupt on Completion)	When set, this bit will prevent the setting of the TI/RI bit of the DMAC Status Register (IDSTS) for the data that ends in the buffer pointed by this descriptor.
0	Reserved	Reserved

The DES1 element contains the buffer size.

**Table 9-3. DES1**

Bits	Name	Description
31:26	Reserved	Reserved
25:13	Reserved	Reserved

Bits	Name	Description
12:0	BS1 (Buffer 1 Size)	Indicates the data buffer byte size, which must be a multiple of four. In the case where the buffer size is not a multiple of four, the resulting behavior is undefined. This field should not be zero.

The DES2 element contains the address pointer to the data buffer.

**Table 9-4. DES2**

Bits	Name	Description
31:0	Buffer Address Pointer 1	These bits indicate the physical address of the data buffer.

The DES3 element contains the address pointer to the next descriptor if the present descriptor is not the last one in a chained descriptor structure.

**Table 9-5. DES3**

Bits	Name	Description
31:0	Next Descriptor Address	If the Second Address Chained (DES0[4]) bit is set, then this address contains the pointer to the physical memory where the Next Descriptor is present. If this is not the last descriptor, then the Next Descriptor address pointer must be DES3[1:0] = 0.

## 9.9 Initialization

### 9.9.1 DMAC Initialization

The DMAC initialization should proceed as follows:

- Write to the DMAC Bus Mode Register (BMOD\_REG) will set the Host bus's access parameters.
- Write to the DMAC Interrupt Enable Register (IDINTEN) will mask any unnecessary interrupt causes.
- The software driver creates either the transmit or the receive descriptor list. Then, it writes to the DMAC Descriptor List Base Address Register (DBADDR), providing the DMAC with the starting address of the list.
- The DMAC engine attempts to acquire descriptors from descriptor lists.

### 9.9.2 DMAC Transmission Initialization

The DMAC transmission occurs as follows:

1. The Host sets up the elements (DES0-DES3) for transmission, and sets the OWN bit (DES0[31]). The Host also prepares the data buffer.
2. The Host programs the write-data command in the CMD register in BIU.
3. The Host also programs the required transmit threshold (TX\_WMARK field in FIFOTH register).

4. The DMAC engine fetches the descriptor and checks the OWN bit. If the OWN bit is not set, it means that the host owns the descriptor. In this case, the DMAC enters a suspend-state and asserts the Descriptor Unable interrupt in the IDSTS register. In such a case, the host needs to release the DMAC by writing any value to PLDMND\_REG.
5. It then waits for the Command Done (CD) bit and no errors from BIU, which indicates that a transfer can be done.
6. Subsequently, the DMAC engine waits for a DMA interface request (dw\_dma\_req) from BIU. This request will be generated, based on the programmed transmit-threshold value. For the last bytes of data which cannot be accessed using a burst, single transfers are performed on the AHB Master Interface.
7. The DMAC fetches the transmit data from the data buffer in the Host memory and transfers them to FIFO for transmission to card.
8. When data span across multiple descriptors, the DMAC fetches the next descriptor and extends its operation using the following descriptor. The last descriptor bit indicates whether the data span multiple descriptors or not.
9. When data transmission is complete, the status information is updated in the IDSTS register by setting the Transmit Interrupt, if it has already been enabled. Also, the OWN bit is cleared by the DMAC by performing a write transaction to DES0.

### 9.9.3 DMAC Reception Initialization

The DMAC reception occurs as follows:

1. The Host sets up the element (DES0-DES3) for reception, and sets the OWN bit (DES0[31]).
2. The Host programs the read-data command in the CMD register in BIU.
3. Then, the Host programs the required level of the receive-threshold (RX\_WMARK field in FIFOTH register).
4. The DMAC engine fetches the descriptor and checks the OWN bit. If the OWN bit is not set, it means that the host owns the descriptor. In this case, the DMA enters a suspend-state and asserts the Descriptor Unable interrupt in the IDSTS register. In such a case, the host needs to release the DMAC by writing any value to PLDMND\_REG.
5. It then waits for the Command Done (CD) bit and no errors from BIU, which indicates that a transfer can be done.
6. The DMAC engine then waits for a DMA interface request (dw\_dma\_req) from BIU. This request will be generated, based on the programmed receive-threshold value. For the last bytes of the data which cannot be accessed using a burst, single transfers are performed on the AHB.
7. The DMAC fetches the data from FIFO and transfers them to the Host memory.
8. When data span across multiple descriptors, the DMAC will fetch the next descriptor and extend its operation using the following descriptor. The last descriptor bit indicates whether the data span multiple descriptors or not.
9. When data reception is complete, the status information is updated in the IDSTS register by setting Receive-Interrupt, if it has already been enabled. Also, the OWN bit is cleared by the DMAC by performing a write-transaction to DES0.



## 9.10 Clock Phase Selection

If the setup time requirements for the input or output data signal are not met, users can specify the clock phase, as shown in the figure below.

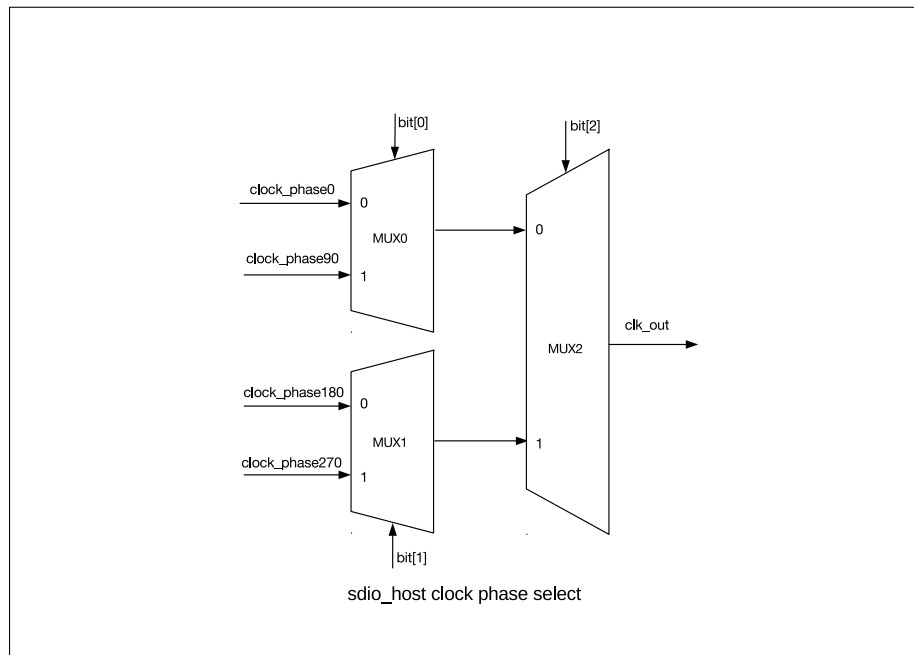


Figure 9-9. Clock Phase Selection

Please find detailed information on the clock phase selection register [CLK\\_EDGE\\_SEL](#) in Section Registers.

## 9.11 Interrupt

Interrupts can be generated as a result of various events. The IDSTS register contains all the bits that might cause an interrupt. The IDINTEN register contains an enable bit for each of the events that can cause an interrupt.

There are two groups of summary interrupts, "Normal" ones (bit8 NIS) and "Abnormal" ones (bit9 AIS), as outlined in the IDSTS register. Interrupts are cleared by writing 1 to the position of the corresponding bit. When all the enabled interrupts within a group are cleared, the corresponding summary bit is also cleared. When both summary bits are cleared, the interrupt signal `dmac_intr_o` is de-asserted (stops signalling).

Interrupts are not queued up, and if a new interrupt-event occurs before the driver has responded to it, no additional interrupts are generated. For example, the Receive Interrupt `IDSTS[1]` indicates that one or more data were transferred to the Host buffer.

An interrupt is generated only once for concurrent events. The driver must scan the IDSTS register for the interrupt cause.

## 9.12 Register Summary

Name	Description	Address	Access
<a href="#">CTRL_REG</a>	Control register	0x0000	R/W
<a href="#">CLKDIV_REG</a>	Clock divider configuration register	0x0008	R/W
<a href="#">CLKSRC_REG</a>	Clock source selection register	0x000C	R/W
<a href="#">CLKENA_REG</a>	Clock enable register	0x0010	R/W

Name	Description	Address	Access
TMOUT_REG	Data and response timeout configuration register	0x0014	R/W
CTYPE_REG	Card bus width configuration register	0x0018	R/W
BLKSIZ_REG	Card data block size configuration register	0x001C	R/W
BYTCNT_REG	Data transfer length configuration register	0x0020	R/W
INTMASK_REG	SDIO interrupt mask register	0x0024	R/W
CMDARG_REG	Command argument data register	0x0028	R/W
CMD_REG	Command and boot configuration register	0x002C	R/W
RESP0_REG	Response data register	0x0030	RO
RESP1_REG	Long response data register	0x0034	RO
RESP2_REG	Long response data register	0x0038	RO
RESP3_REG	Long response data register	0x003C	RO
MINTSTS_REG	Masked interrupt status register	0x0040	RO
RINTSTS_REG	Raw interrupt status register	0x0044	R/W
STATUS_REG	SD/MMC status register	0x0048	RO
FIFOTH_REG	FIFO configuration register	0x004C	R/W
CDETECT_REG	Card detect register	0x0050	RO
WRTPRT_REG	Card write protection (WP) status register	0x0054	RO
TCBCNT_REG	Transferred byte count register	0x005C	RO
TBBCNT_REG	Transferred byte count register	0x0060	RO
DEBNCE_REG	Debounce filter time configuration register	0x0064	R/W
USRID_REG	User ID (scratchpad) register	0x0068	R/W
RST_N_REG	Card reset register	0x0078	R/W
BMOD_REG	Burst mode transfer configuration register	0x0080	R/W
PLDMND_REG	Poll demand configuration register	0x0084	WO
DBADDR_REG	Descriptor base address register	0x0088	R/W
IDSTS_REG	IDMAC status register	0x008C	R/W
IDINTEN_REG	IDMAC interrupt enable register	0x0090	R/W
DSCADDR_REG	Host descriptor address pointer	0x0094	RO
BUFADDR_REG	Host buffer address pointer register	0x0098	RO
CLK_EDGE_SEL	Clock phase selection register	0x0800	R/W

## 9.13 Registers

SD/MMC controller registers can be accessed by the APB bus of the CPU.

**Register 9.1. CTRL\_REG (0x0000)**

(reserved)	(reserved)	(reserved)	CEATA_DEVICE_INTERRUPT_STATUS	SEND_AUTO_STOP_CCSD	SEND_CCSD	ABORT_READ_DATA	SEND_IRQ_RESPONSE	READ_WAIT	(reserved)	INT_ENABLE	(reserved)	DMA_RESET	FIFO_RESET	CONTROLLER_RESET		
31	25	24	23	12	11	10	9	8	7	6	5	4	3	2	1	0
0x00	1	0x00	0	0	0	0	0	0	0	0	0	0	0	0	0	0

Reset

**CEATA\_DEVICE\_INTERRUPT\_STATUS** Software should appropriately write to this bit after the power-on reset or any other reset to the CE-ATA device. After reset, the CE-ATA device's interrupt is usually disabled ( $nIEN = 1$ ). If the host enables the CE-ATA device's interrupt, then software should set this bit. (R/W)

**SEND\_AUTO\_STOP\_CCSD** Always set `send_auto_stop_ccsd` and `send_ccsd` bits together; `send_auto_stop_ccsd` should not be set independently of `send_ccsd`. When set, SD/MMC automatically sends an internally-generated STOP command (CMD12) to the CE-ATA device. After sending this internally-generated STOP command, the Auto Command Done (ACD) bit in RINTSTS is set and an interrupt is generated for the host, in case the ACD interrupt is not masked. After sending the Command Completion Signal Disable (CCSD), SD/MMC automatically clears the `send_auto_stop_ccsd` bit. (R/W)

**SEND\_CCSD** When set, SD/MMC sends CCSD to the CE-ATA device. Software sets this bit only if the current command is expecting CCS (that is, `RW_BLK`), and if interrupts are enabled for the CE-ATA device. Once the CCSD pattern is sent to the device, SD/MMC automatically clears the `send_ccsd` bit. It also sets the Command Done (CD) bit in the RINTSTS register, and generates an interrupt for the host, in case the Command Done interrupt is not masked. NOTE: Once the `send_ccsd` bit is set, it takes two card clock cycles to drive the CCSD on the CMD line. Due to this, within the boundary conditions the CCSD may be sent to the CE-ATA device, even if the device has signalled CCS. (R/W)

**ABORT\_READ\_DATA** After a suspend-command is issued during a read-operation, software polls the card to find when the suspend-event occurred. Once the suspend-event has occurred, software sets the bit which will reset the data state machine that is waiting for the next block of data. This bit is automatically cleared once the data state machine is reset to idle. (R/W)

**SEND\_IRQ\_RESPONSE** Bit automatically clears once response is sent. To wait for MMC card interrupts, host issues CMD40 and waits for interrupt response from MMC card(s). In the meantime, if host wants SD/MMC to exit waiting for interrupt state, it can set this bit, at which time SD/MMC command state-machine sends CMD40 response on bus and returns to idle state. (R/W)

Continued on the next page...

**Register 9.1. CTRL\_REG (0x0000)**

Continued from the previous page...

**READ\_WAIT** For sending read-wait to SDIO cards. (R/W)

**INT\_ENABLE** Global interrupt enable/disable bit. 0: Disable; 1: Enable. (R/W)

**DMA\_RESET** To reset DMA interface, firmware should set bit to 1. This bit is auto-cleared after two AHB clocks. (R/W)

**FIFO\_RESET** To reset FIFO, firmware should set bit to 1. This bit is auto-cleared after completion of reset operation. Note: FIFO pointers will be out of reset after 2 cycles of system clocks in addition to synchronization delay (2 cycles of card clock), after the fifo\_reset is cleared. (R/W)

**CONTROLLER\_RESET** To reset controller, firmware should set this bit. This bit is auto-cleared after two AHB and two cclk\_in clock cycles. (R/W)

**Register 9.2. CLKDIV\_REG (0x0008)**

<i>CLK_DIVIDER3</i>				<i>CLK_DIVIDER2</i>				<i>CLK_DIVIDER1</i>				<i>CLK_DIVIDER0</i>											
31					24	23					16	15					8	7					0
0x000				0x000				0x000				0x000				Reset							

**CLK\_DIVIDER3** Clock divider-3 value. Clock division factor is  $2^n$ , where  $n=0$  bypasses the divider (division factor of 1). For example, a value of 1 means divide by  $2^1 = 2$ , a value of 0xFF means divide by  $2^{255} = 510$ , and so on. In MMC-Ver3.3-only mode, these bits are not implemented because only one clock divider is supported. (R/W)

**CLK\_DIVIDER2** Clock divider-2 value. Clock division factor is  $2^n$ , where  $n=0$  bypasses the divider (division factor of 1). For example, a value of 1 means divide by  $2^1 = 2$ , a value of 0xFF means divide by  $2^{255} = 510$ , and so on. In MMC-Ver3.3-only mode, these bits are not implemented because only one clock divider is supported. (R/W)

**CLK\_DIVIDER1** Clock divider-1 value. Clock division factor is  $2^n$ , where  $n=0$  bypasses the divider (division factor of 1). For example, a value of 1 means divide by  $2^1 = 2$ , a value of 0xFF means divide by  $2^{255} = 510$ , and so on. In MMC-Ver3.3-only mode, these bits are not implemented because only one clock divider is supported. (R/W)

**CLK\_DIVIDER0** Clock divider-0 value. Clock division factor is  $2^n$ , where  $n=0$  bypasses the divider (division factor of 1). For example, a value of 1 means divide by  $2^1 = 2$ , a value of 0xFF means divide by  $2^{255} = 510$ , and so on. In MMC-Ver3.3-only mode, these bits are not implemented because only one clock divider is supported. (R/W)

**Register 9.3. CLKSRC\_REG (0x000C)**

31	(reserved)	4	3	0	
0x000000				0x0	Reset

**CLKSRC\_REG** Clock divider source for two SD cards is supported. Each card has two bits assigned to it. For example, bit[1:0] are assigned for card 0, bit[3:2] are assigned for card 1. Card 0 maps and internally routes clock divider[0:3] outputs to cclk\_out[1:0] pins, depending on bit value.

00 : Clock divider 0;

01 : Clock divider 1;

10 : Clock divider 2;

11 : Clock divider 3.

In MMC-Ver3.3-only controller, only one clock divider is supported. The cclk\_out is always from clock divider 0, and this register is not implemented. (R/W)

**Register 9.4. CLKENA\_REG (0x0010)**

31	(reserved)	2	1	0	
0x00000				0x00000	Reset

**CCLK\_ENABEL** Clock-enable control for two SD card clocks and one MMC card clock is supported.

0: Clock disabled;

1: Clock enabled.

In MMC-Ver3.3-only mode, since there is only one cclk\_out, only cclk\_enable[0] is used. (R/W)

**Register 9.5. TMOUT\_REG (0x0014)**

<i>DATA_TIMEOUT</i>																<i>RESPONSE_TIMEOUT</i>																	
31																8	7																0
0x0FFFFFFF																0x040																Reset	

**DATA\_TIMEOUT** Value for card data read timeout. This value is also used for data starvation by host timeout. The timeout counter is started only after the card clock is stopped. This value is specified in number of card output clocks, i.e. `cclk_out` of the selected card.

NOTE: The software timer should be used if the timeout value is in the order of 100 ms. In this case, read data timeout interrupt needs to be disabled. (R/W)

**RESPONSE\_TIMEOUT** Response timeout value. Value is specified in terms of number of card output clocks, i.e., `cclk_out`. (R/W)

**Register 9.6. CTYPE\_REG (0x0018)**

<i>(reserved)</i>																<i>CARD_WIDTH8</i>																<i>(reserved)</i>																<i>CARD_WIDTH4</i>																
31																18	17	16	15																2	1	0																											
0x00000																0x00000																0x00000																0x00000																Reset

**CARD\_WIDTH8** One bit per card indicates if card is in 8-bit mode.

0: Non 8-bit mode;

1: 8-bit mode.

Bit[17:16] correspond to card[1:0] respectively. (R/W)

**CARD\_WIDTH4** One bit per card indicates if card is 1-bit or 4-bit mode.

0: 1-bit mode;

1: 4-bit mode.

Bit[1:0] correspond to card[1:0] respectively. Only `NUM_CARDS*2` number of bits are implemented. (R/W)

**Register 9.7. BLKSIZ\_REG (0x001C)**

<i>(reserved)</i>																<i>BLOCK_SIZE</i>																	
31																16	15																0
0 0 0 0 0 0 0 0 0 0 0 0 0 0 0 0																0x00200																Reset	

**BLOCK\_SIZE** Block size. (R/W)

**Register 9.8. BYTCNT\_REG (0x0020)**

31	0
0x000000200	
Reset	

**BYTCNT\_REG** Number of bytes to be transferred, should be an integral multiple of Block Size for block transfers. For data transfers of undefined byte lengths, byte count should be set to 0. When byte count is set to 0, it is the responsibility of host to explicitly send stop/abort command to terminate data transfer. (R/W)

**Register 9.9. INTMASK\_REG (0x0024)**

(reserved)		SDIO_INT_MASK		INT_MASK	
31	18	17	16	15	0
0x00000		0x00000		0x00000	
Reset					

**SDIO\_INT\_MASK** SDIO interrupt mask, one bit for each card. Bit[17:16] correspond to card[15:0] respectively. When masked, SDIO interrupt detection for that card is disabled. 0 masks an interrupt, and 1 enables an interrupt. In MMC-Ver3.3-only mode, these bits are always 0. (R/W)

**INT\_MASK** These bits used to mask unwanted interrupts. A value of 0 masks interrupt, and a value of 1 enables the interrupt. (R/W)

Bit 15 (EBE): End-bit error, read/write (no CRC)

Bit 14 (ACD): Auto command done

Bit 13 (SBE/BCI): Start Bit Error/Busy Clear Interrupt

Bit 12 (HLE): Hardware locked write error

Bit 11 (FRUN): FIFO underrun/overflow error

Bit 10 (HTO): Data starvation-by-host timeout/Volt\_switch\_int

Bit 9 (DRTO): Data read timeout

Bit 8 (RTO): Response timeout

Bit 7 (DCRC): Data CRC error

Bit 6 (RCRC): Response CRC error

Bit 5 (RXDR): Receive FIFO data request

Bit 4 (TXDR): Transmit FIFO data request

Bit 3 (DTO): Data transfer over

Bit 2 (CD): Command done

Bit 1 (RE): Response error

Bit 0 (CD): Card detect

**Register 9.10. CMDARG\_REG (0x0028)**

31	0
0x00000000	
Reset	

**CMDARG\_REG** Value indicates command argument to be passed to the card. (R/W)

**Register 9.11. CMD\_REG (0x002C)**

31	30	29	28	27	26	25	24	23	22	21	20	16	15	14	13	12	11	10	9	8	7	6	5	0													
START_CMD (reserved)		USE_HOLE (reserved)		(reserved)		(reserved)		(reserved)		CCS_EXPECTED		READ_CEATA_DEVICE		UPDATE_CLOCK_REGISTERS_ONLY		CARD_NUMBER		SEND_INITIALIZATION		STOP_ABORT_CMD		WAIT_PRVDATA_COMPLETE		TRANSFER_MODE		READ_WRITE		DATA_EXPECTED		CHECK_RESPONSE_CRC		RESPONSE_LENGTH		RESPONSE_EXPECT		CMD_INDEX	
0		0		1		0		0		0		0		0		0		0		0		0		0		0		0		0		0		0		0	
												0x00																		0x00							
Reset																																					

**START\_CMD** Start command. Once command is served by the CIU, this bit is automatically cleared.

When this bit is set, host should not attempt to write to any command registers. If a write is attempted, hardware lock error is set in raw interrupt register. Once command is sent and a response is received from SD/MMC\_CEATA cards, Command Done bit is set in the raw interrupt Register. (R/W)

**USE\_HOLE** Use Hold Register. (R/W) 0: CMD and DATA sent to card bypassing HOLD Register; 1: CMD and DATA sent to card through the HOLD Register.

**CCS\_EXPECTED** Expected Command Completion Signal (CCS) configuration. (R/W)

0: Interrupts are not enabled in CE-ATA device (nIEN = 1 in ATA control register), or command does not expect CCS from device.

1: Interrupts are enabled in CE-ATA device (nIEN = 0), and RW\_BLK command expects command completion signal from CE-ATA device.

If the command expects Command Completion Signal (CCS) from the CE-ATA device, the software should set this control bit. SD/MMC sets Data Transfer Over (DTO) bit in RINTSTS register and generates interrupt to host if Data Transfer Over interrupt is not masked.

**READ\_CEATA\_DEVICE** Read access flag. (R/W)

0: Host is not performing read access (RW\_REG or RW\_BLK) towards CE-ATA device

1: Host is performing read access (RW\_REG or RW\_BLK) towards CE-ATA device.

Software should set this bit to indicate that CE-ATA device is being accessed for read transfer.

This bit is used to disable read data timeout indication while performing CE-ATA read transfers.

Maximum value of I/O transmission delay can be no less than 10 seconds. SD/MMC should not indicate read data timeout while waiting for data from CE-ATA device. (R/W)

**Continued on the next page...**



**Register 9.11. CMD\_REG (0x002C)**

Continued from the previous page...

**UPDATE\_CLOCK\_REGISTERS\_ONLY** (R/W)

0: Normal command sequence.

1: Do not send commands, just update clock register value into card clock domain

Following register values are transferred into card clock domain: CLKDIV, CLRSRC, and CLKENA. Changes card clocks (change frequency, truncate off or on, and set low-frequency mode). This is provided in order to change clock frequency or stop clock without having to send command to cards.

During normal command sequence, when update\_clock\_registers\_only = 0, following control registers are transferred from BIU to CIU: CMD, CMDARG, TMOUT, CTYPE, BLKSIZ, and BYTCNT. CIU uses new register values for new command sequence to card(s). When bit is set, there are no Command Done interrupts because no command is sent to SD\_MMC\_CEATA cards.

**CARD\_NUMBER** Card number in use. Represents physical slot number of card being accessed. In MMC-Ver3.3-only mode, up to two cards are supported. In SD-only mode, up to two cards are supported. (R/W)

**SEND\_INITIALIZATION** (R/W)

0: Do not send initialization sequence (80 clocks of 1) before sending this command.

1: Send initialization sequence before sending this command.

After power on, 80 clocks must be sent to card for initialization before sending any commands to card. Bit should be set while sending first command to card so that controller will initialize clocks before sending command to card.

**STOP\_ABORT\_CMD** (R/W)

0: Neither stop nor abort command can stop current data transfer. If abort is sent to function-number currently selected or not in data-transfer mode, then bit should be set to 0.

1: Stop or abort command intended to stop current data transfer in progress. When open-ended or predefined data transfer is in progress, and host issues stop or abort command to stop data transfer, bit should be set so that command/data state-machines of CIU can return correctly to idle state.

**WAIT\_PRVDATA\_COMPLETE** (R/W)

0: Send command at once, even if previous data transfer has not completed;

1: Wait for previous data transfer to complete before sending Command.

The wait\_prvdata\_complete = 0 option is typically used to query status of card during data transfer or to stop current data transfer. card\_number should be same as in previous command.

**SEND\_AUTO\_STOP** (R/W)

0: No stop command is sent at the end of data transfer;

1: Send stop command at the end of data transfer.

Continued on the next page...

**Register 9.11. CMD\_REG (0x002C)**

Continued from the previous page ...

**TRANSFER\_MODE** (R/W)

- 0: Block data transfer command;
- 1: Stream data transfer command. Don't care if no data expected.

**READ/WRITE** (R/W)

- 0: Read from card;
  - 1: Write to card.
- Don't care if no data is expected from card.

**DATA\_EXPECTED** (R/W)

- 0: No data transfer expected.
- 1: Data transfer expected.

**CHECK\_RESPONSE\_CRC** (R/W)

- 0: Do not check;
- 1: Check response CRC.

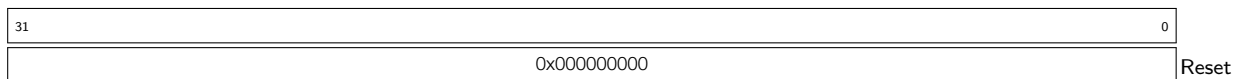
Some of command responses do not return valid CRC bits. Software should disable CRC checks for those commands in order to disable CRC checking by controller.

**RESPONSE\_LENGTH** (R/W)

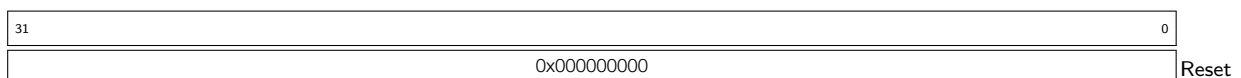
- 0: Short response expected from card;
- 1: Long response expected from card.

**RESPONSE\_EXPECT** (R/W)

- 0: No response expected from card;
- 1: Response expected from card.

**CMD\_INDEX** Command index. (R/W)**Register 9.12. RESP0\_REG (0x0030)**

**RESP0\_REG** Bit[31:0] of response. (RO)

**Register 9.13. RESP1\_REG (0x0034)**

**RESP1\_REG** Bit[63:32] of long response. (RO)

**Register 9.14. RESP2\_REG (0x0038)**

31	0
0x00000000	
Reset	

**RESP2\_REG** Bit[95:64] of long response. (RO)

**Register 9.15. RESP3\_REG (0x003C)**

31	0
0x00000000	
Reset	

**RESP3\_REG** Bit[127:96] of long response. (RO)

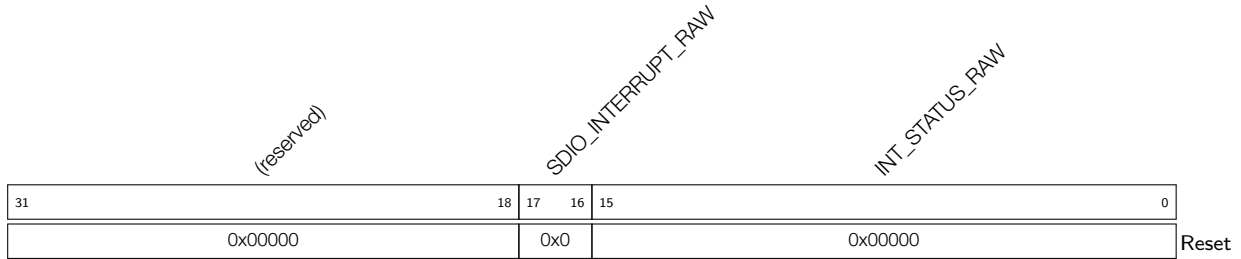
**Register 9.16. MINTSTS\_REG (0x0040)**

31	(reserved)	SDIO_INTERRUPT_MSK	INT_STATUS_MSK	0
18	17	16	15	
0		0x0	0x00000	
Reset				

**SDIO\_INTERRUPT\_MSK** Interrupt from SDIO card, one bit for each card. Bit[17:16] correspond to card1 and card0, respectively. SDIO interrupt for card is enabled only if corresponding sdio\_int\_mask bit is set in Interrupt mask register (Setting mask bit enables interrupt). (RO)

**INT\_STATUS\_MSK** Interrupt enabled only if corresponding bit in interrupt mask register is set. (RO)

- Bit 15 (EBE): End-bit error, read/write (no CRC)
- Bit 14 (ACD): Auto command done
- Bit 13 (SBE/BCI): Start Bit Error/Busy Clear Interrupt
- Bit 12 (HLE): Hardware locked write error
- Bit 11 (FRUN): FIFO underrun/overrun error
- Bit 10 (HTO): Data starvation by host timeout (HTO)
- Bit 9 (DTRO): Data read timeout
- Bit 8 (RTO): Response timeout
- Bit 7 (DCRC): Data CRC error
- Bit 6 (RCRC): Response CRC error
- Bit 5 (RXDR): Receive FIFO data request
- Bit 4 (TXDR): Transmit FIFO data request
- Bit 3 (DTO): Data transfer over
- Bit 2 (CD): Command done
- Bit 1 (RE): Response error
- Bit 0 (CD): Card detect

**Register 9.17. RINTSTS\_REG (0x0044)**

**SDIO\_INTERRUPT\_RAW** Interrupt from SDIO card, one bit for each card. Bit[17:16] correspond to card1 and card0, respectively. Setting a bit clears the corresponding interrupt bit and writing 0 has no effect. (R/W)

0: No SDIO interrupt from card;

1: SDIO interrupt from card.

In MMC-Ver3.3-only mode, these bits are always 0. Bits are logged regardless of interrupt-mask status. (R/W)

**INT\_STATUS\_RAW** Setting a bit clears the corresponding interrupt and writing 0 has no effect. Bits are logged regardless of interrupt mask status. (R/W)

Bit 15 (EBE): End-bit error, read/write (no CRC)

Bit 14 (ACD): Auto command done

Bit 13 (SBE/BCI): Start Bit Error/Busy Clear Interrupt

Bit 12 (HLE): Hardware locked write error

Bit 11 (FRUN): FIFO underrun/overflow error

Bit 10 (HTO): Data starvation by host timeout (HTO)

Bit 9 (DTRO): Data read timeout

Bit 8 (RTO): Response timeout

Bit 7 (DCRC): Data CRC error

Bit 6 (RCRC): Response CRC error

Bit 5 (RXDR): Receive FIFO data request

Bit 4 (TXDR): Transmit FIFO data request

Bit 3 (DTO): Data transfer over

Bit 2 (CD): Command done

Bit 1 (RE): Response error

Bit 0 (CD): Card detect

**Register 9.18. STATUS\_REG (0x0048)**

(reserved)		FIFO_COUNT															RESPONSE_INDEX		DATA_STATE_MC_BUSY			COMMAND_FSM_STATES			FIFO_FULL		FIFO_EMPTY		FIFO_TX_WATERMARK		FIFO_RX_WATERMARK	
31	30	29															17	16				4	3	2	1	0						
0	0	0x000														0x00		1	1	1	0x01			0	1	1	0					

Reset

**FIFO\_COUNT** FIFO count, number of filled locations in FIFO. (RO)

**RESPONSE\_INDEX** Index of previous response, including any auto-stop sent by core. (RO)

**DATA\_STATE\_MC\_BUSY** Data transmit or receive state-machine is busy. (RO)

**DATA\_BUSY** Inverted version of raw selected card\_data[0]. (RO)

- 0: Card data not busy;
- 1: Card data busy.

**DATA\_3\_STATUS** Raw selected card\_data[3], checks whether card is present. (RO)

- 0: card not present;
- 1: card present.

**COMMAND\_FSM\_STATES** Command FSM states. (RO)

- 0: Idle
- 1: Send init sequence
- 2: Send cmd start bit
- 3: Send cmd tx bit
- 4: Send cmd index + arg
- 5: Send cmd crc7
- 6: Send cmd end bit
- 7: Receive resp start bit
- 8: Receive resp IRQ response
- 9: Receive resp tx bit
- 10: Receive resp cmd idx
- 11: Receive resp data
- 12: Receive resp crc7
- 13: Receive resp end bit
- 14: Cmd path wait NCC
- 15: Wait, cmd-to-response turnaround

**FIFO\_FULL** FIFO is full status. (RO)

**FIFO\_EMPTY** FIFO is empty status. (RO)

**FIFO\_TX\_WATERMARK** FIFO reached Transmit watermark level, not qualified with data transfer. (RO)

**FIFO\_RX\_WATERMARK** FIFO reached Receive watermark level, not qualified with data transfer. (RO)

**Register 9.19. FIFOTH\_REG (0x004C)**

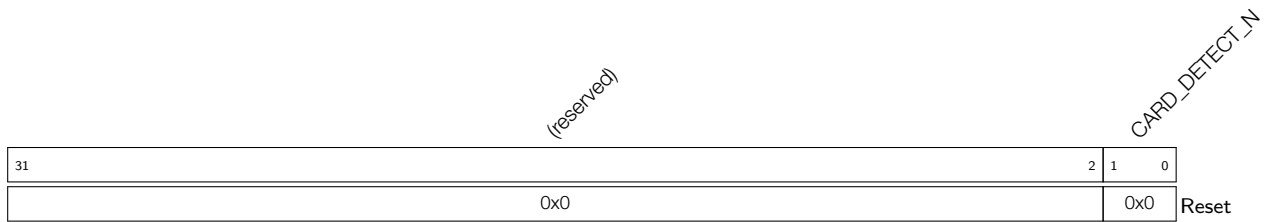
(reserved)		DMA_MULTIPLE_TRANSACTION_SIZE				(reserved)				RX_WMARK				(reserved)				TX_WMARK			
31	30	28	27	26		16	15	12	11										0		
0	0x0	0	x	x	x	x	x	x	x	x	x	x	x	x	0	0	0	0	0x0000		

Reset

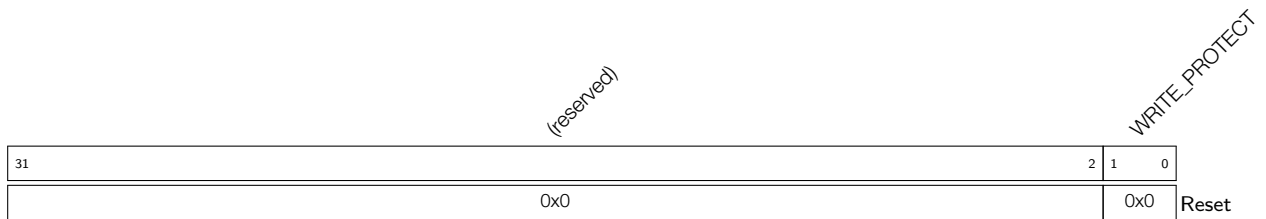
**DMA\_MULTIPLE\_TRANSACTION\_SIZE** Burst size of multiple transaction, should be programmed same as DMA controller multiple-transaction-size SRC/DEST\_MSIZ. 000: 1-byte transfer; 001: 4-byte transfer; 010: 8-byte transfer; 011: 16-byte transfer; 100: 32-byte transfer; 101: 64-byte transfer; 110: 128-byte transfer; 111: 256-byte transfer. (R/W)

**RX\_WMARK** FIFO threshold watermark level when receiving data to card. When FIFO data count reaches greater than this number (FIFO\_RX\_WATERMARK), DMA/FIFO request is raised. During end of packet, request is generated regardless of threshold programming in order to complete any remaining data. In non-DMA mode, when receiver FIFO threshold (RXDR) interrupt is enabled, then interrupt is generated instead of DMA request. During end of packet, interrupt is not generated if threshold programming is larger than any remaining data. It is responsibility of host to read remaining bytes on seeing Data Transfer Done interrupt. In DMA mode, at end of packet, even if remaining bytes are less than threshold, DMA request does single transfers to flush out any remaining bytes before Data Transfer Done interrupt is set. (R/W)

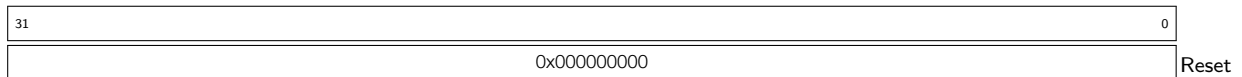
**TX\_WMARK** FIFO threshold watermark level when transmitting data to card. When FIFO data count is less than or equal to this number (FIFO\_TX\_WATERMARK), DMA/FIFO request is raised. If Interrupt is enabled, then interrupt occurs. During end of packet, request or interrupt is generated, regardless of threshold programming. In non-DMA mode, when transmit FIFO threshold (TXDR) interrupt is enabled, then interrupt is generated instead of DMA request. During end of packet, on last interrupt, host is responsible for filling FIFO with only required remaining bytes (not before FIFO is full or after CIU completes data transfers, because FIFO may not be empty). In DMA mode, at end of packet, if last transfer is less than burst size, DMA controller does single cycles until required bytes are transferred. (R/W)

**Register 9.20. CDETECT\_REG (0x0050)**

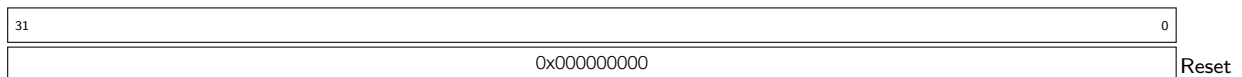
**CARD\_DETECT\_N** Value on card\_detect\_n input ports (1 bit per card), read-only bits.0 represents presence of card. Only NUM\_CARDS number of bits are implemented. (RO)

**Register 9.21. WRTPRT\_REG (0x0054)**

**WRITE\_PROTECT** Value on card\_write\_prt input ports (1 bit per card).1 represents write protection. Only NUM\_CARDS number of bits are implemented. (RO)

**Register 9.22. TCBCNT\_REG (0x005C)**

**TCBCNT\_REG** Number of bytes transferred by CIU unit to card. (RO)

**Register 9.23. TBBCNT\_REG (0x0060)**

**TBBCNT\_REG** Number of bytes transferred between Host/DMA memory and BIU FIFO. (RO)

**Register 9.24. DEBNCE\_REG (0x0064)**

<i>(reserved)</i>								<i>DEBOUNCE_COUNT</i>																								
31								24																23								0
0 0 0 0 0 0 0 0								0x00000000																								Reset

**DEBOUNCE\_COUNT** Number of host clocks (clk) used by debounce filter logic. The typical debounce time is 5 ~ 25 ms to prevent the card instability when the card is inserted or removed. (R/W)

**Register 9.25. USRID\_REG (0x0068)**

31																														0
0x000000000																														Reset

**USRID\_REG** User identification register, value set by user. Default reset value can be picked by user while configuring core before synthesis. Can also be used as a scratchpad register by user. (R/W)

**Register 9.26. RST\_N\_REG (0x0078)**

<i>(reserved)</i>																												<i>RST_CARD_RESET</i>		
31																				2	1	0								
0																			0x1			Reset								

**RST\_CARD\_RESET** Hardware reset. 1: Active mode; 0: Reset. These bits cause the cards to enter pre-idle state, which requires them to be re-initialized. **CARD\_RESET[0]** should be set to 1'b0 to reset card0, **CARD\_RESET[1]** should be set to 1'b0 to reset card1. The number of bits implemented is restricted to **NUM\_CARDS**. (R/W)



**Register 9.27. BMOD\_REG (0x0080)**

(reserved)											BMOD_PBL		BMOD_DE		(reserved)		BMOD_FB BMOD_SWR				
31											11	10	8	7	6			2	1	0	
0	0	0	0	0	0	0	0	0	0	0	0	0	0	0	0	0	0	0	0	0	0
											0x0		0		0x00		0		0		Reset

**BMOD\_PBL** Programmable Burst Length. These bits indicate the maximum number of beats to be performed in one IDMAC transaction. The IDMAC will always attempt to burst as specified in PBL each time it starts a burst transfer on the host bus. The permissible values are 1, 4, 8, 16, 32, 64, 128 and 256. This value is the mirror of MSIZE of FIFOTH register. In order to change this value, write the required value to FIFOTH register. This is an encode value as follows:

000: 1-byte transfer; 001: 4-byte transfer; 010: 8-byte transfer; 011: 16-byte transfer; 100: 32-byte transfer; 101: 64-byte transfer; 110: 128-byte transfer; 111: 256-byte transfer.

PBL is a read-only value and is applicable only for data access, it does not apply to descriptor access. (R/W)

**BMOD\_DE** IDMAC Enable. When set, the IDMAC is enabled. (R/W)

**BMOD\_FB** Fixed Burst. Controls whether the AHB Master interface performs fixed burst transfers or not. When set, the AHB will use only SINGLE, INCR4, INCR8 or INCR16 during start of normal burst transfers. When reset, the AHB will use SINGLE and INCR burst transfer operations. (R/W)

**BMOD\_SWR** Software Reset. When set, the DMA Controller resets all its internal registers. It is automatically cleared after one clock cycle. (R/W)

**Register 9.28. PLDMND\_REG (0x0080)**

31																				0	
0x00000000																					Reset

**PLDMND\_REG** Poll Demand. If the OWN bit of a descriptor is not set, the FSM goes to the Suspend state. The host needs to write any value into this register for the IDMAC FSM to resume normal descriptor fetch operation. This is a write only register, PD bit is write-only. (WO)

**Register 9.29. DBADDR\_REG (0x0088)**

31																				0	
0x00000000																					Reset

**DBADDR\_REG** Start of Descriptor List. Contains the base address of the First Descriptor. The LSB bits [1:0] are ignored and taken as all-zero by the IDMAC internally. Hence these LSB bits may be treated as read-only. (R/W)



**Register 9.31. IDINTEN\_REG (0x0090)**

(reserved)										IDINTEN_AI	IDINTEN_NI	(reserved)		IDINTEN_CES	IDINTEN_DU	(reserved)		IDINTEN_FBE	IDINTEN_RI	IDINTEN_TI			
31											10	9	8	7	6	5	4	3	2	1	0		
0 0										0	0	0	0	0	0	0	0	0	0	0	0	0	Reset

**IDINTEN\_AI** Abnormal Interrupt Summary Enable. (R/W)

When set, an abnormal interrupt is enabled. This bit enables the following bits:

IDINTEN[2]: Fatal Bus Error Interrupt;

IDINTEN[4]: DU Interrupt.

**IDINTEN\_NI** Normal Interrupt Summary Enable. (R/W)

When set, a normal interrupt is enabled. When reset, a normal interrupt is disabled. This bit enables the following bits:

IDINTEN[0]: Transmit Interrupt;

IDINTEN[1]: Receive Interrupt.

**IDINTEN\_CES** Card Error summary Interrupt Enable. When set, it enables the Card Interrupt summary. (R/W)

**IDINTEN\_DU** Descriptor Unavailable Interrupt. When set along with Abnormal Interrupt Summary Enable, the DU interrupt is enabled. (R/W)

**IDINTEN\_FBE** Fatal Bus Error Enable. When set with Abnormal Interrupt Summary Enable, the Fatal Bus Error Interrupt is enabled. When reset, Fatal Bus Error Enable Interrupt is disabled. (R/W)

**IDINTEN\_RI** Receive Interrupt Enable. When set with Normal Interrupt Summary Enable, Receive Interrupt is enabled. When reset, Receive Interrupt is disabled. (R/W)

**IDINTEN\_TI** Transmit Interrupt Enable. When set with Normal Interrupt Summary Enable, Transmit Interrupt is enabled. When reset, Transmit Interrupt is disabled. (R/W)

**Register 9.32. DSCADDR\_REG (0x0094)**

31	0
0x00000000	
Reset	

**DSCADDR\_REG** Host Descriptor Address Pointer, updated by IDMAC during operation and cleared on reset. This register points to the start address of the current descriptor read by the IDMAC. (RO)

**Register 9.33. BUFADDR\_REG (0x0098)**

31	0
0x00000000	
Reset	

**BUFADDR\_REG** Host Buffer Address Pointer, updated by IDMAC during operation and cleared on reset. This register points to the current Data Buffer Address being accessed by the IDMAC. (RO)

**Register 9.34. CLK\_EDGE\_SEL (0x0800)**

(reserved)		<i>CCLKIN_EDGE_N</i>		<i>CCLKIN_EDGE_L</i>		<i>CCLKIN_EDGE_H</i>		<i>CCLKIN_EDGE_SLF_SEL</i>		<i>CCLKIN_EDGE_SAM_SEL</i>		<i>CCLKIN_EDGE_DRV_SEL</i>	
31	21	20	17	16	13	12	9	8	6	5	3	2	0
0x000		0x1		0x0		0x1		0x0		0x0		0x0	
													Reset

**CCLKIN\_EDGE\_N** This value should be equal to CCLKIN\_EDGE\_L. (R/W)

**CCLKIN\_EDGE\_L** The low level of the divider clock. The value should be larger than CCLKIN\_EDGE\_H. (R/W)

**CCLKIN\_EDGE\_H** The high level of the divider clock. The value should be smaller than CCLKIN\_EDGE\_L. (R/W)

**CCLKIN\_EDGE\_SLF\_SEL** It is used to select the clock phase of the internal signal from phase90, phase180, or phase270. (R/W)

**CCLKIN\_EDGE\_SAM\_SEL** It is used to select the clock phase of the input signal from phase90, phase180, or phase270. (R/W)

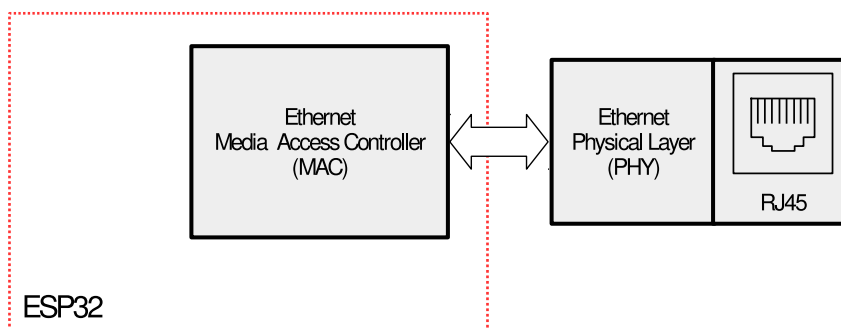
**CCLKIN\_EDGE\_DRV\_SEL** It is used to select the clock phase of the output signal from phase90, phase180, or phase270. (R/W)

## 10 Ethernet Media Access Controller (MAC)

### 10.1 Overview

#### Features of Ethernet

By using the external Ethernet PHY (physical layer), ESP32 can send and receive data via Ethernet MAC (Media Access Controller) according to the IEEE 802.3 standard, as Figure 10-1 shows. Ethernet is currently the most commonly used network protocol that controls how data is transmitted over local- and wide-area networks, abbreviated as LAN and WAN, respectively.



**Figure 10-1. Ethernet MAC Functionality Overview**

ESP32 MAC Ethernet complies with the following criteria:

- IEEE 802.3-2002 for Ethernet MAC
- IEEE 1588-2008 standard for specifying the accuracy of networked clock synchronization
- Two industry-standard interfaces conforming with IEEE 802.3-2002: Media-Independent Interface (MII) and Reduced Media-Independent Interface (RMII).

#### Features of MAC Layer

- Support for a data transmission rate of 10 Mbit/s or 100 Mbit/s through an external PHY interface
- Communication with an external Fast Ethernet PHY through IEEE 802.3-compliant MII and RMII interfaces
- Support for:
  - Carrier Sense Multiple Access / Collision Detection (CSMA/CD) protocol in half-duplex mode
  - IEEE 802.3x flow control in full-duplex mode
  - operations in full-duplex mode, forwarding the received pause-control frame to the user application
  - backpressure flow control in half-duplex mode
  - If the flow control input signal disappears during a full-duplex operation, a pause frame with zero pause time value is automatically transmitted.
- The Preamble and the Start Frame Delimiter (SFD) are inserted in the Transmit path, and deleted in the Receive path.

- Cyclic Redundancy Check (CRC) and Pad can be controlled on a per-frame basis.
- The Pad is generated automatically, if data is below the minimum frame length.
- Programmable frame length supporting jumbo frames of up to 16 KB
- Programmable Inter-frame Gap (IFG) (40-96 bit times in steps of 8)
- Support for a variety of flexible address filtering modes:
  - Up to eight 48-bit perfect address filters to mask each byte
  - Up to eight 48-bit SA address comparison checks to mask each byte
  - All multicast address frames can be transmitted
  - All frames in mixed mode can be transmitted without being filtered for network monitoring
  - A status report is attached each time all incoming packets are transmitted and filtered
- Returning a 32-bit status for transmission and reception of packets respectively
- Separate transmission, reception, and control interfaces for the application
- Use of the Management Data Input/Output (MDIO) interface to configure and manage PHY devices
- Support for the offloading of received IPv4 and TCP packets encapsulated by an Ethernet frame in the reception function
- Support for checking IPv4 header checksums, as well as TCP, UDP, or ICMP (Internet Control Message Protocol) checksums encapsulated in IPv4/IPv6 packets in the enhanced reception function
- Support for Ethernet frame timestamps. (For details please refer to IEEE 1588-2008.) Each frame has a 64-bit timestamp when transmitted or received.
- Two sets of FIFOs: one 2 KB Tx FIFO with programmable threshold and one 2 KB Rx FIFO with configurable threshold (64 bytes by default)
- When Rx FIFO stores multiple frames, the Receive Status Vector is inserted into the Rx FIFO after transmitting an EOF (end of frame), so that the Rx FIFO does not need to store the Receive Status of these frames.
- In store-and-forward mode, all error frames can be filtered during reception, but not forwarded to the application.
- Under-sized good frames can be forwarded.
- Support for data statistics by generating pulses for lost or corrupted frames in the Rx FIFO due to an overflow
- Support for store-and-forward mechanism when transmitting data to the MAC core
- Automatic re-transmission of collided frames during transmission (subject to certain conditions, see section [10.2.1.2](#))
- Discarding frames in cases of late collisions, excessive collisions, excessive deferrals, and under-run conditions
- The Tx FIFO is flushed by software control.
- Calculating the IPv4 header checksum, as well as the TCP, UDP, or ICMP checksum, and then inserting them into frames transmitted in store-and-forward mode.

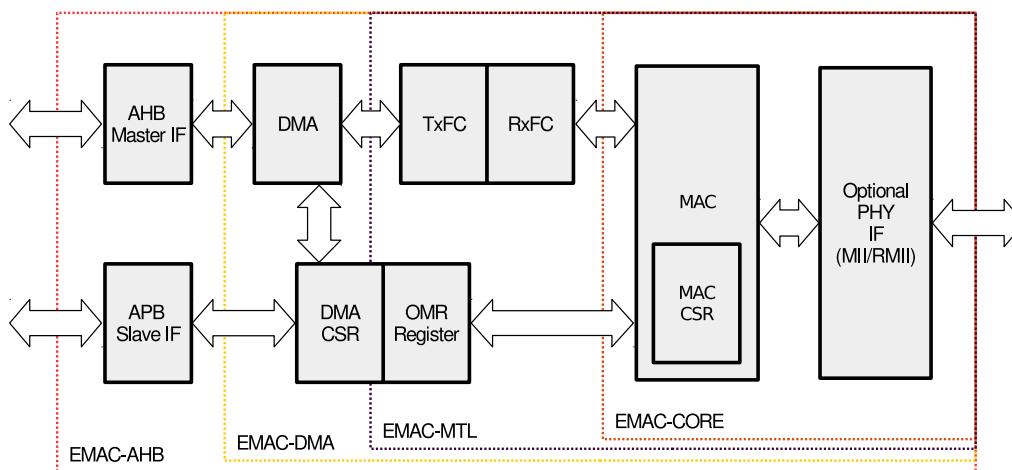


Figure 10-2. Ethernet Block Diagram

## Ethernet Block Diagram

Figure 10-2 shows the block diagram of the Ethernet.

Ethernet MAC consists of the MAC-layer configuration register module and three layers: EMAC\_CORE (MAC Core Layer), EMAC\_MTL (MAC Transition Layer), and EMAC\_DMA (Direct Memory Access). Each of these three layers has two directions: Tx and Rx. They are connected to the system through the Advanced High-Performance Bus (AHB) and the Advanced Peripheral Bus (APB) on the chip. Off the chip, they communicate with the external PHY through the MII and RMII interfaces to establish an Ethernet connection.

## 10.2 EMAC\_CORE

The MAC supports many interfaces with the PHY chip. The PHY interface can be selected only once after reset. The MAC communicates with the application side (DMA side), using the MAC Transmit Interface (MTI), MAC Receive Interface (MRI) and the MAC Control Interface (MCI).

### 10.2.1 Transmit Operation

A transmit operation is initiated when the MTL Application pushes in data at the time a response signal is asserted. When the SOF (start of frame) signal is detected, the MAC accepts the data and begins transmitting to the RMII or MII. The time required to transmit the frame data to the RMII or MII, after the application initiates transmission, varies, depending on delay factors like IFG delay, time to transmit Preamble or SFD (Start Frame Delimiter), and any back-off delays in half-duplex mode. Until then, the MAC does not accept the data received from MTL by de-asserting the ready signal.

After the EOF (end of frame) is transmitted to the MAC, the MAC completes the normal transmission and yields the Transmit Status to the MTL. If a normal collision (in half-duplex mode) occurs during transmission, the MAC makes valid the Transmit Status in the MTL. It then accepts and drops all further data until the next SOF is received. The MTL block should retransmit the same frame from SOF upon observing a retry request (in the Status) from the MAC.

The MAC issues an underflow status if the MTL is not able to provide the data continuously during transmission. During the normal transmission of a frame from MTL, if the MAC receives an SOF without getting an EOF for the previous frame, it ignores the SOF and considers the new frame as a continuation of the previous one.

### 10.2.1.1 Transmit Flow Control

In full-duplex mode, when the Transmit Flow Control Enable bit (TFE bit in the Flow Control Register) is set to 1, the MAC will generate and send a pause frame, as needed. The pause frame is added and transmitted together with the calculated CRC. The generation of pause frames can be initiated in two ways.

When the application sets the Flow Control Busy bit (FCB bit in the Flow Control Register) to 1, or when the Rx FIFO is full, a pause frame is transmitted.

- If an application has requested flow control by setting the FCB bit in the Flow Control Register to 1, the MAC will generate and send a single pause frame. The pause time value in the generated frame is the pause time value programmed in the Flow Control Register. To extend or end the pause time before the time specified in the previously transmitted pause frame, the application program must configure the pause time value in the Flow Control Register to the appropriate value and, then, request another pause frame transmission.
- If the application has requested flow control when the Rx FIFO is full, the MAC will generate and transmit a pause frame. The value of the pause time of the generated frame is the pause time value programmed in the Flow Control Register. If the Rx FIFO remains full during the configurable interval, which is determined by the Pause Low Threshold bit (PLT) in the Flow Control Register before the pause time expires, a second pause frame will be transmitted. As long as the Rx FIFO remains full, the process repeats itself. If the FIFO is no longer full before the sample time, the MAC will send a pause frame with zero pause time, indicating to the remote end that the Rx buffer is ready to receive the new data frame.

### 10.2.1.2 Retransmission During a Collision

In half-duplex mode, a collision may occur on the MAC line interface when frames are transmitted to the MAC. The MAC may even give a status to indicate a retry before the end of the frame is received. The retransmission is then enabled and the frame is popped out from the FIFO. When more than 96 bytes are transmitted to the MAC core, the FIFO controller frees the space in the FIFO, allowing the DMA to push more data into FIFO. This means that data cannot be retransmitted after the threshold is exceeded or when the MAC core indicates that a late collision has occurred.

The MAC transmitter may abort the transmission of a frame because of collision, Tx FIFO underflow, loss of carrier, jabber timeout, no carrier, excessive deferral, and late collision. When frame transmission is aborted because of collision, the MAC requests retransmission of the frame.

### 10.2.2 Receive Operation

A receive operation is initiated when the MAC detects an SFD on the RMII or MII. The MAC strips the Preamble and SFD before processing the frame. The header fields are checked for the filtering and the FCS (Frame Check Sequence) field used to verify the CRC for the frame. The received frame is stored in a shallow buffer until the address filtering is performed. The frame is dropped in the MAC if it fails the address filtering.

The frame received by the MAC will be pushed into the Rx FIFO. Once the FIFO status exceeds the Receive Threshold, configured by the Receive Threshold Control (RTC) bit in the Operation Mode register, the DMA can initiate a preconfigured burst transmission to the AHB interface.

In the default pass-through mode, when the FIFO receives a complete packet or 64 bytes configured by the RTC bit in the Operation Mode Register, the data pops up and its availability is notified to the DMA. After the DMA initiates the transmission to the AHB interface, the data transmission continues from the FIFO until the complete packet is transmitted. Upon completing transmitting the EOF, the status word will pop up and be transmitted to



the DMA controller.

In the Rx FIFO Store-and-Forward mode (configured through the RSF or Receive Store and Forward bit in the Operation Mode Register), only the valid frames are read and forwarded to the application. In the passthrough mode, error frames are not discarded because the error status is received at the end of the frame. The start of frame will have been read from the FIFO at that point.

### 10.2.2.1 Reception Protocol

After the receive module receives the packets, the Preamble and SFD of the received frames are removed. When the SFD is detected, the MAC starts sending Ethernet frame data to the Rx FIFO, starting at the first byte (destination address) following the SFD. This timestamp is passed on to the application, unless the MAC filters out and drops the frame.

If the received frame length/type is less than 0x600 and the automatic CRC/Pad removal option is programmed for the MAC, the MAC will send frame data to the Rx FIFO (the amount of data does not exceed the number specified in the length/type field). Then MAC begins discarding the remaining section, including the FCS field. If the frame length/type is greater than, or equal to, 0x600, the MAC will send all received Ethernet frame data to the Rx FIFO, regardless of the programmed value of the automatic CRC removal option. By default, the MAC watchdog timer is enabled, meaning that frames, including DA, SA, LT, data, pad and FCS, which exceed 2048 bytes, are cut off. This function can be disabled by programming the Watchdog Disable (WD) bit in the MAC Configuration Register. However, even if the watchdog timer is disabled, frames longer than 16 KB will be cut off and the watchdog timeout status will be given.

### 10.2.2.2 Receive Frame Controller

If the RA (Receive All) bit in the MAC Frame Filter Register is reset, the MAC will filter frames based on the destination and source addresses. If the application decides not to receive any bad frames, such as runt frames and CRC error frames, another level of filtering is needed. When a frame fails the filtering, the frame is discarded and is not transmitted to the application. When the filter parameters are changed dynamically, if a frame fails the DA and SA filterings, the remaining part of the frame is discarded and the Receive Status word is updated immediately and, therefore, the zero frame length bit, CRC error bit, and runt frame error bit are set to 1. This indicates that the frame has failed the filtering.

### 10.2.2.3 Receive Flow Control

The MAC will detect the received pause frame and pause transmission of frames for a specified delay within the received pause frame (in full-duplex mode only). The Pause Frame Detect Function can be enabled or disabled by the RFCE (Receive Flow Control Enable) bit in the Flow Control Register. When receive flow control is enabled, it starts monitoring whether the destination address of the received frame matches the multicast address of the control frame (0x0180 C200 0001). If a match is detected (i.e. the destination address of the received frame matches the destination address of the reserved control frame), the MAC will determine whether to transmit the received control frame to the application, according to the PCF (Pass Control Frames) bit in the Frame Filter Register.

The MAC will also decode the type, the opcode, and the pause timer field of the Receive Control Frame. If the value of the status byte counter is 64 bits and there are no CRC errors, the MAC transmitter will halt the transmission of any data frame. The duration of the pause is the decoded pause time value multiplied by the interval (which is 64

bytes for both 10 Mbit/s and 100 Mb/s modes). At the same time, if another pause frame of zero pause time is detected, the MAC will reset the pause time to manage the new pause request.

If the type field (0x8808), the opcode (0x00001), and the byte length (64 bytes) of the received control frame are not 0x8808, 0x00001, and 64 bytes, respectively, or if there is a CRC error, the MAC will not generate a pause.

If a pause frame has a multicast destination address, the MAC filters the frame, according to the address matching.

For pause frames with a unicast destination address, the MAC checks whether the DA matches the content of the EMACADDR0 Register, and whether the Unicast Pause Frame Detect (UPFD) bit in the Flow Control Register is set to 1. The Pass Control Frames (PCF) bits in the Frame Filter Register [7:6] control the filtering of frames and addresses.

#### 10.2.2.4 Reception of Multiple Frames

Since the status is available immediately after the data is received. Frames can be stored there, as long as the FIFO is not full.

#### 10.2.2.5 Error Handling

If the Rx FIFO is full before receiving the EOF data from the MAC, an overflow will be generated and the entire frame will be discarded. In fact, status bit RDES0[11] will indicate that this frame is partial due to an overflow, and that it should be discarded.

If the function that corresponds to the Flush Transmit FIFO (FTF) bit and the Forward Undersized Good Frames (FUGF) bit in the Operation Mode Register is enabled, the Rx FIFO can filter error frames and runt frames. If the receive FIFO is configured to operate in store-and-forward mode, all error frames will be filtered and discarded.

In passthrough mode, if a frame's status and length are available when reading a SOF from the Rx FIFO, the entire error frame can be discarded. DMA can clear the error frame being read from the FIFO by enabling the Receive Frame Clear bit. The data transmission to the application (DMA) will then stop, and the remaining frames will be read internally and discarded. If FIFO is available, the transmission of the next frame will be initiated.

#### 10.2.2.6 Receive Status Word

After receiving the Ethernet frames, the MAC outputs the receive status to the application. The detailed description of the receive status is the same as that which is configured by bit [31:0] in RDES0.

### 10.3 MAC Interrupt Controller

The MAC core can generate interrupts due to various events.

The interrupt register bits only indicate various interrupt events. To clear the interrupts, the corresponding status register and other registers must be read. An Interrupt Status Register describes the events that prompt the MAC core to generate interrupts. Each interrupt event can be prevented by setting the corresponding mask bit in the Interrupt Mask Register to 1. For example, if bit3 of the interrupt register is set high, it indicates that a magic packet or Wake-on-LAN frame has been received in Power-down mode. The PMT Control and Status register must be read to clear this interrupt event.

## 10.4 MAC Address Filtering

Address filtering will check the destination and source addresses of all received frames and report the address filtering status accordingly. For example, filtered frames can be identified either as multicast or broadcast. The address check, then, is based on the parameters selected by the application (Frame Filter Registers).

Physical (MAC) addresses are used for address checking during address filtering.

### 10.4.1 Unicast Destination Address Filtering

The MAC supports up to 8 MAC addresses for perfect filtering of unicast addresses. If a perfect filtering is selected (by resetting bit[1] in the Frame Filter Register), the MAC compares all 48 bits of the received unicast address with the programmed MAC address to determine if there is a match. By default, EMACADDR0 is always enabled, and the other addresses (EMACADDR0 ~ EMACADDR7) are selected by a separate enable bit. When the individual bytes of the other addresses (EMACADDR0 ~ EMACADDR7) are compared with the DA bytes received, the latter can be masked by setting the corresponding Mask Byte Control bit in the register to 1. This facilitates the DA group address filtering.

### 10.4.2 Multicast Destination Address Filtering

The MAC can be programmed to pass all multicast frames by setting the Pass All Multicast (PAM) bit in the Frame Filter Register to 1. If the PAM bit is reset, the MAC will filter multicast addresses, according to Bit[2] in the Frame Filter Register.

In perfect filtering mode, the multicast address is compared with the programmed MAC Destination Address Registers (EMACADDR0 ~ EMACADDR7). Group address filtering is also supported.

### 10.4.3 Broadcast Address Filtering

The MAC does not filter any broadcast frames in the default mode. However, if the MAC is programmed to reject all broadcast frames, which can happen by setting the Disable Broadcast Frames (DBF) bit in the Frame Filter Register to 1, all broadcast frames will be discarded.

### 10.4.4 Unicast Source Address Filtering

The MAC may also perform a perfect filtering based on the source address field of the received frame. By default, the Address Filtering Module (AFM) compares the Source Address (SA) field with the values programmed in the SA register. By setting Bit[30] in the SA register to 1, the MAC Address Register (EMACADDR0 - EMACADDR7) can be configured to contain SA, instead of Destination Address (DA), for filtering. Group filtering with SA is also supported. If the Source Address Filter (SAF) enable bit in the Frame Filter Register is set to 1, the MAC discards frames that do not pass the SA filtering. Otherwise, the result of SA filtering is given as a status bit in the Receive Status word (Please refer to Table 10-11).

When the SAF enable bit is set to 1, the result of the SA filtering and DA filtering is AND'ed to determine whether or not to forward the frame. Any frame that fails to pass will be discarded. Frames need to pass both filterings in order to be forwarded to the application.

### 10.4.5 Inverse Filtering Operation

For both destination address (DA) and source address (SA) filtering, you can invert the results matched through the filtering at the final output. The inverse filtering of DA and SA are controlled by the DAIF and SAIF bits, respectively, in the Frame Filter Register. The DAIF bit applies to both unicast and multicast DA frames. When DAIF is set to 1, the result of unicast or multicast destination address filtering will be inverted. Similarly, when the SAIF bit is set to 1, the result of unicast SA filtering is reversed.

The following two tables summarize the destination address and source address filtering, based on the type of the frames received.

**Table 10-1. Destination Address Filtering**

Frame Type	PM	PF	DAIF	PAM	DB	DA Filter Result
Broadcast	1	X	X	X	X	Pass
	0	X	X	X	0	Pass
	0	X	X	X	1	Fail
Unicast	1	X	X	X	X	All frames pass.
	0	X	0	X	X	Pass when results of perfect/group filtering match.
	0	X	1	X	X	Fail when results of perfect/group filtering match.
	0	1	0	X	X	Pass when results of perfect/group filtering match.
	0	1	1	X	X	Fail when results of perfect/group filtering match.
Multicast	1	X	X	X	X	All frames pass.
	X	X	X	1	X	All frames pass.
	0	X	0	0	X	Pass when results of perfect/group filtering match and pause control frame is discarded, if PCF = 0x.
	0	1	0	0	X	Pass when results of perfect/group filtering match and pause control frame is discarded, if PCF = 0x.
	0	X	1	0	X	Fail when results of perfect/group filtering match and pause control frame is discarded, if PCF = 0x.
	0	1	1	0	X	Fail when results of perfect/group filtering match and pause control frame is discarded, if PCF = 0x.

The filtering parameters in the MAC Frame Filter Register described in Table 10-1 are as follows.

**Parameter name:**

PM: Pass All Multicast

PF: Perfect Filter

DAIF: Destination Address Inverse Filtering

PAM: Pass All Multicast

DB: Disable Broadcast Frames

**Parameter setting:**

1: Set

0: Cleared

**Table 10-2. Source Address Filtering**

Frame Type	PM	SAIF	SAF	Source Address Filter Operation
Unicast	1	X	X	Pass all frames
	0	0	0	Pass when results of perfect/group filtering match. Frames not passed are not discarded.
	0	1	0	Fail when results of perfect/group filtering match. Frames not passed are not discarded.
	0	0	1	Pass when results of perfect/group filtering match. Frames not passed are discarded.
	0	1	1	Fail when results of perfect/group filtering match. Frames not passed are discarded.

The filtering parameters in the MAC Frame Filter Register described in Table 10-2 are as follows.

Parameter name:	Parameter setting:
PM: Pass All Multicast	1: Set
SAF: Source Address Filtering	0: Cleared
SAIF: Source Address Inverse Filtering	X: Don't care

### 10.4.6 Good Transmitted Frames and Received Frames

A frame successfully transmitted is considered a "good frame". In other words, a transmitted frame is considered to be good, if the frame transmission is not aborted due to the following errors:

- Jabber timeout
- No carrier or loss of carrier
- Late collision
- Frame underflow
- Excessive deferral
- Excessive collision

The received frames are considered "good frames", if there are not any of the following errors:

- CRC error
- Runt frames (frames shorter than 64 bytes)
- Alignment error (in 10/100 Mbps modes only)
- Length error (non-type frames only)
- Frame size over the maximum size (for non-type frames over the maximum frame size only)
- MII\_RXER input error

The maximum frame size depends on the frame type:

- The maximum size of untagged frames = 1518 bytes
- The maximum size of VLAN frames = 1522 bytes

## 10.5 EMAC\_MTL (MAC Transaction Layer)

The MAC Transaction Layer provides FIFO memory to buffer and regulates the frames between the application system memory and the MAC. It also enables the data to be transmitted between the application clock domain and the MAC clock domains. The MTL layer has two data paths, namely the Transmit path and the Receive path. The data path for both directions is 32-bit wide and operates with a simple FIFO protocol.

## 10.6 PHY Interface

The DMA and the Host driver communicate through two data structures:

- Control and Status Registers (CSR)
- Descriptor lists and data buffers

For details please refer to [Register Summary](#) and [Linked List Descriptors](#).

### 10.6.1 MII (Media Independent Interface)

Media Independent Interface (MII) defines the interconnection between MAC sublayers and PHYs at the data transmission rate of 10 Mbit/s and 100 Mbit/s.

#### 10.6.1.1 Interface Signals Between MII and PHY

Interface signals between MII and PHY are shown in Figure 10-3.

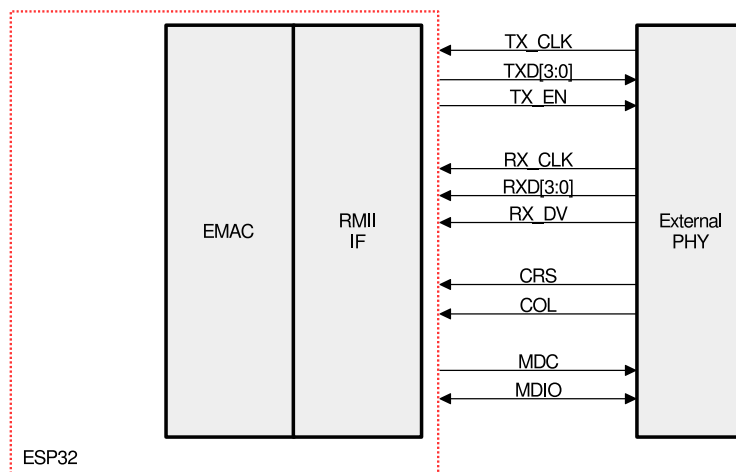


Figure 10-3. MII Interface

MII Interface Signal Description:

- **MII\_TX\_CLK**: TX clock signal. This signal provides the reference timing for TX data transmission. The frequencies are divided into two types: 2.5 MHz at a data transmission rate of 10 Mbit/s, and 25 MHz at 100 Mbit/s.
- **MII\_TXD[3:0]**: Transmit data signal in groups of four, syn-driven by the MAC sub-layer, and valid only when the MII\_TX\_EN signal is valid. MII\_TXD[0] is the lowest significant bit and MII\_TXD[3] is the highest significant bit. When the signal MII\_TX\_EN is pulled low, sending data does not have any effect on the PHY.
- **MII\_TX\_EN**: Transmit data enable signal. This signal indicates that the MAC is currently sending nibbles (4 bits) for the MII. This signal must be synchronized with the first nibble of the header (MII\_TX\_CLK) and must be synchronized when all nibbles to be transmitted are sent to the MII.
- **MII\_RX\_CLK**: RX clock signal. This signal provides the reference timing for RX data transmission. The frequencies are divided into two types: 2.5 MHz at the data transmission rate of 10 Mbit/s, and 25 MHz at 100 Mbit/s.
- **MII\_RXD[3:0]**: Receive data signal in groups of four, syn-driven by the PHY, and valid only when MII\_RX\_DV signal is valid. MII\_RXD[0] is the lowest significant bit and MII\_RXD[3] is the highest significant bit. When MII\_RX\_DV is disabled and MII\_RX\_ER is enabled, the specific MII\_RXD[3:0] value represents specific information from the PHY.
- **MII\_RX\_DV**: Receive data valid signal. This signal indicates that the PHY is currently receiving the recovered and decoded nibble that will be transmitted to the MII. This signal must be synchronized with the first nibble of the recovered frame (MII\_RX\_CLK) and remain synchronized till the last nibble of the recovered frame. This signal must be disabled before the first clock cycle following the last nibble. In order to receive the frame

correctly, the MII\_RX\_DV signal must cover the frame to be received over the time range, starting no later than when the SFD field appears.

- MII\_CRFS: Carrier sense signal. When the transmitting or receiving medium is in the non-idle state, the signal is enabled by the PHY. When the transmitting or receiving medium is in the idle state, the signal is disabled by the PHY. The PHY must ensure that the MII\_CRFS signal remains valid under conflicting conditions. This signal does not need to be synchronized with the TX and RX clocks. In full-duplex mode, this signal is insignificant.
- MII\_COL: Collision detection signal. After a collision is detected on the medium, the PHY must immediately enable the collision detection signal, and the collision detection signal must remain active as long as a condition for collision exists. This signal does not need to be synchronized with the TX and RX clocks. In full-duplex mode, this signal is meaningless.
- MII\_RX\_ER: Receive error signal. The signal must remain for one or more cycles (MII\_RX\_CLK) to indicate to the MAC sublayer that an error has been detected somewhere in the frame.
- MDIO and MDC: Management Data Input/Output and Management Data Clock. The two signals constitute a serial bus defined for the Ethernet family of IEEE 802.3 standards, used to transfer control and data information to the PHY, see section [Station Management Agent \(SMA\) Interface](#).

### 10.6.1.2 MII Clock

In MII mode, there are two directions of clock, Tx and Rx clocks in the interface between MII and the PHY. MII\_TX\_CLK is used to synchronize the TX data, and MII\_RX\_CLK is used to synchronize the RX data. The MII\_RX\_CLK clock is provided by the PHY. The MII\_TX\_CLK is provided by the chip's internal PLL or external crystal oscillator. For details regarding Figure 10-4, please refer to the clock-related registers in [Register Summary](#).

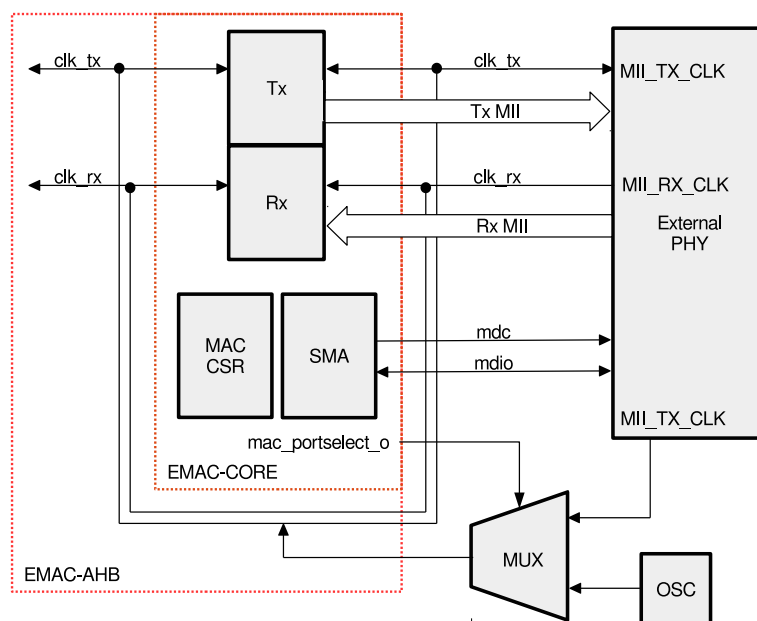


Figure 10-4. MII Clock

## 10.6.2 RMII (Reduced Media-Independent Interface)

RMII interface signals are shown in figure 10-5.

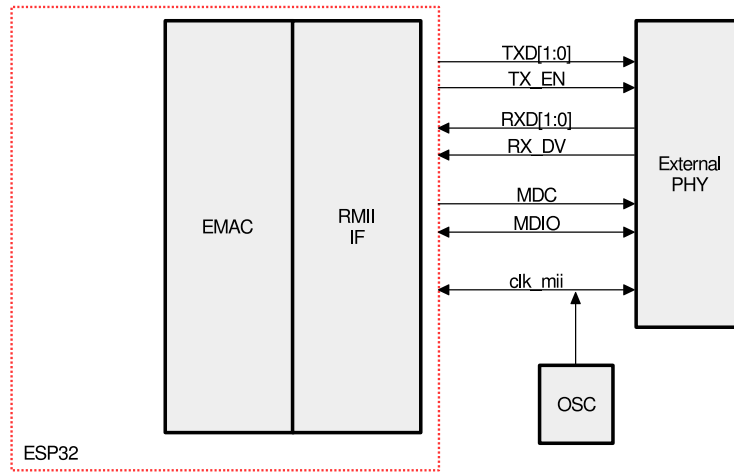


Figure 10-5. RMII Interface

### 10.6.2.1 RMII Interface Signal Description

The Reduced Media-Independent Interface (RMII) specification reduces the number of pins between the microcontroller's external peripherals and the external PHY at a data transmission rate of 10 Mbit/s or 100 Mbit/s. According to the IEEE 802.3u standard, MII includes 16 pins that contain data and control signals. The RMII specification reduces 62.5% of the pins to the number of seven.

RMII has the following features:

- Support for an operating rate of 10 Mbit/s or 100 Mbit/s
- The reference clock frequency must be 50 MHz.
- The same reference clock must be provided externally both to the MAC and the external Ethernet PHY. It provides independent 2-bit-wide Tx and Rx data paths.

### 10.6.2.2 RMII Clock

The configuration of the RMII clock is as figure 10-6 shows.



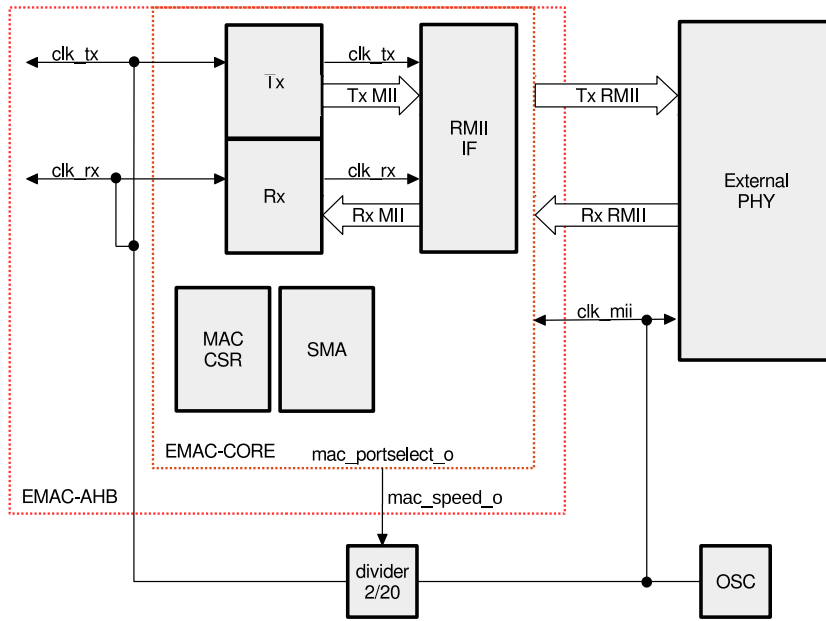


Figure 10-6. RMIIClock

### 10.6.3 Station Management Agent (SMA) Interface

As Figure 10-4 shows, the MAC uses MDC and MDIO signals to transfer control and data information to the PHY. The maximum clock frequency is 2.5 MHz. The clock is generated from the application clock by a clock divider. The PHY transmits register data during a write/read operation through the MDIO. This signal is driven synchronously to the MDC clock.

Please refer to [Register Summary](#) for details about the EMII Address Register and the EMII Data Register.

### 10.6.4 RMIITiming

This section describes the RMIITiming specifications.

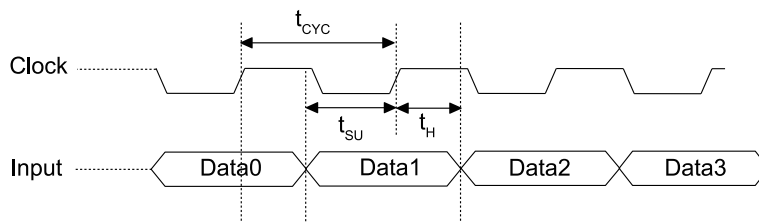


Figure 10-7. RMIITiming - Receiving Data

Table 10-3. Timing Parameters - Receiving Data

Timing Parameters	Description	Min	Typ	Max	Unit
$t_{CYC}$	Clock cycle	20	20	20	ns
$t_{SU}$	Setup time	4	–	–	ns
$t_H$	Hold time	1	–	–	ns
$t_{ID}$	Input delay	3	5	8	ns

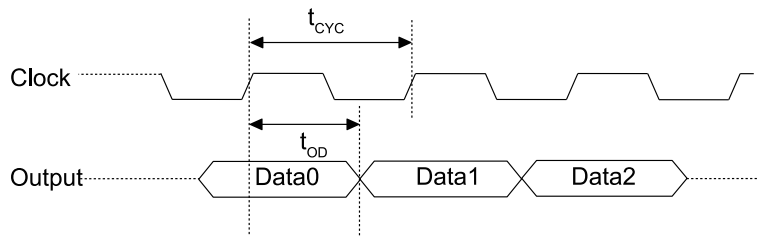


Figure 10-8. RMI Timing – Transmitting Data

Table 10-4. Timing Parameters – Transmitting Data

Timing Parameters	Description	Min	Typ	Max	Unit
$t_{CYC}$	Clock cycle	20	20	20	ns
$t_{SU}$	Setup time	4	–	–	ns
$t_H$	Hold time	1	–	–	ns
$t_{OD}$	Output delay	6	9	12	ns

### 10.7 Ethernet DMA Features

The DMA has independent Transmit and Receive engines, and a CSR (Control and Status Registers) space. The Transmit engine transfers data from the system memory to the device port (MTL), while the Receive engine transmits data from the device port to the system memory. The controller uses descriptors to efficiently move data from source to destination with minimal Host CPU intervention. The DMA is designed for packet-oriented data transmission, such as frames in Ethernet. The controller can be programmed to interrupt the Host CPU for normal situations, such as the completion of frame transmission or reception, or when errors occur.

### 10.8 Linked List Descriptors

This section shows the structure of the linked lists and the descriptors. Every linked list consists of eight words.

#### 10.8.1 Transmit Descriptors

The structure of the transmitter linked lists is shown in Figure 10-9. Table 10-5 to Table 10-10 show the description of the linked lists.

	31						0
TDES0	OWN	Ctrl[30:26]	TSE	Ctrl[24:18]	TSS	Status[16:7]	Ctrl/status [6:3] Status [2:0]
TDES1	Ctrl [31:29]	Reserved				Transmit Buffer Size[12:0]	
TDES2	Buffer Address [31:0]						
TDES3	Next Descriptor Address[31:0]						
TDES4	Reserved						
TDES5	Reserved						
TDES6	Transmit Frame Timestamp Low[31:0]						
TDES7	Transmit Frame Timestamp High[31:0]						

Figure 10-9. Transmit Descriptor

**Table 10-5. Transmit Descriptor 0 (TDES0)**

Bits	Name	Description
[31]	OWN: Own Bit	When set, this bit indicates that the descriptor is owned by the DMA. When this bit is reset, it indicates that the descriptor is owned by the Host. The DMA clears this bit, either when it completes the frame transmission or when the buffers allocated to the descriptor are empty. The ownership bit of the First Descriptor of the frame should be set after all subsequent descriptors belonging to the same frame have been set. This avoids a possible race condition between fetching a descriptor and the driver setting an ownership bit.
[30]	IC: Interrupt on Completion	When set, this bit sets the Transmit Interrupt (Register 5[0]) after the present frame has been transmitted. This bit is valid only when the last segment bit (TDES0[29]) is set.
[29]	LS: Last Segment	When set, this bit indicates that the buffer contains the last segment of the frame. When this bit is set, the TBS1 or TBS2 field in TDES1 should have a non-zero value.
[28]	FS: First Segment	When set, this bit indicates that the buffer contains the first segment of a frame.
[27]	DC: Disable CRC	When this bit is set, the MAC does not append a cyclic redundancy check (CRC) to the end of the transmitted frame. This is valid only when the first segment (TDES0[28]) is set.
[26]	DP: Disable Pad	When set, the MAC does not automatically add padding to a frame shorter than 64 bytes. When this bit is reset, the DMA automatically adds padding and CRC to a frame shorter than 64 bytes, and the CRC field is added despite the state of the DC (TDES0[27]) bit. This is valid only when the first segment (TDES0[28]) is set.
[25]	TTSE: Transmit Timestamp Enable	When set, this bit enables IEEE1588 hardware timestamping for the transmit frame referenced by the descriptor. This field is valid only when the First Segment control bit (TDES0[28]) is set.
[24]	CRCR: CRC Replacement Control	When set, the MAC replaces the last four bytes of the transmitted packet with recalculated CRC bytes. The host should ensure that the CRC bytes are present in the frame being transmitted from the Transmit Buffer. This bit is valid when the First Segment control bit (TDES0[28]) is set. In addition, CRC replacement is done only when Bit TDES0[27] is set to 1.

Bits	Name	Description
[23:22]	CIC: Checksum Insertion Control	<p>These bits control the checksum calculation and insertion. The following list describes the bit encoding:</p> <ul style="list-style-type: none"> <li>• 2'b00: Checksum insertion is disabled.</li> <li>• 2'b01: Only IP header checksum calculation and insertion are enabled.</li> <li>• 2'b10: IP header checksum and payload checksum calculation and insertion are enabled, but pseudo-header checksum is not calculated in hardware.</li> <li>• 2'b11: IP Header checksum and payload checksum calculation and insertion are enabled, and pseudo-header checksum is calculated in hardware.</li> </ul> <p>This field is valid when the First Segment control bit (TDES0[28]) is set.</p>
[21]	TER: Transmit End of Ring	When set, this bit indicates that the descriptor list reached its final descriptor. The DMA returns to the base address of the list, creating a Descriptor Ring.
[20]	TCH: Second Address Chained	When set, this bit indicates that the second address in the descriptor is the Next Descriptor address, rather than the second buffer address. When TDES0[20] is set, TBS2 (TDES1[28:16]) is a "don't care" value. TDES0[21] takes precedence over TDES0[20]. This bit should be set to 1.
[19:18]	VLIC: VLAN Insertion Control	<p>When set, these bits request the MAC to perform VLAN tagging or untagging before transmitting the frames. If the frame is modified for VLAN tags, the MAC automatically recalculates and replaces the CRC bytes. The following list describes the values of these bits:</p> <ul style="list-style-type: none"> <li>• 2'b00: Do not add a VLAN tag.</li> <li>• 2'b01: Remove the VLAN tag from the frames before transmission. This option should be used only with the VLAN frames.</li> <li>• 2'b10: Insert a VLAN tag with the tag value programmed in VLAN Tag Inclusion or Replacement Register.</li> <li>• 2'b11: Replace the VLAN tag in frames with the Tag value programmed in VLAN Tag Inclusion or Replacement Register. This option should be used only with the VLAN frames.</li> </ul>
[17]	TTSS: Transmit Timestamp Status	This field is used as a status bit to indicate that a timestamp was captured for the described transmit frame. When this bit is set, TDES2 and TDES3 have a timestamp value captured for the transmit frame. This field is only valid when the descriptor's Last Segment control bit (TDES0[29]) is set.

Bits	Name	Description
[16]	IHE: IP Header Error	When set, this bit indicates that the MAC transmitter detected an error in the IP datagram header. The transmitter checks the header length in the IPv4 packet against the number of header bytes received from the application, and indicates an error status if there is a mismatch. For IPv6 frames, a header error is reported if the main header length is not 40 bytes. Furthermore, the Ethernet Length/Type field value for an IPv4 or IPv6 frame must match the IP header version received with the packet. For IPv4 frames, an error status is also indicated if the Header Length field has a value less than 0x5.
[15]	ES: Error Summary	Indicates the logical OR of the following bits: <ul style="list-style-type: none"> <li>• TDES0[14]: Jabber Timeout</li> <li>• TDES0[13]: Frame Flush</li> <li>• TDES0[11]: Loss of Carrier</li> <li>• TDES0[10]: No Carrier</li> <li>• TDES0[9]: Late Collision</li> <li>• TDES0[8]: Excessive Collision</li> <li>• TDES0[2]: Excessive Deferral</li> <li>• TDES0[1]: Underflow Error</li> <li>• TDES0[16]: IP Header Error</li> <li>• TDES0[12]: IP Payload Error</li> </ul>
[14]	JT: Jabber Timeout	When set, this bit indicates the MAC transmitter has experienced a jabber timeout. This bit is only set when EMACCONFIG_REG's bit EMACJABBER is not set.
[13]	FF: Frame Flushed	When set, this bit indicates that the DMA or MTL flushed the frame because of a software Flush command given by the CPU.

Bits	Name	Description
[12]	IPE: IP Payload Error	When set, this bit indicates that MAC transmitter detected an error in the TCP, UDP, or ICMP IP datagram payload. The transmitter checks the payload length received in the IPv4 or IPv6 header against the actual number of TCP, UDP, or ICMP packet bytes received from the application, and issues an error status in case of a mismatch.
[11]	LOC: Loss of Carrier	When set, this bit indicates that a loss of carrier occurred during frame transmission (that is, the MII_CRS signal was inactive for one or more transmit clock periods during frame transmission). This is valid only for the frames transmitted without collision when the MAC operates in the half-duplex mode.
[10]	NC: No Carrier	When set, this bit indicates that the Carrier Sense signal from the PHY was not asserted during transmission.
[9]	LC: Late Collision	When set, this bit indicates that frame transmission is aborted because of a collision occurring after the collision window (64 byte-times including Preamble in MII mode, and 512 byte-times including Preamble and Carrier Extension). This bit is not valid if the Underflow Error bit is set.
[8]	EC: Excessive Collision	When set, this bit indicates that the transmission was aborted after 16 successive collisions while attempting to transmit the current frame. If bit EMACRETRY of EMACCONFIG_REG is set, this bit is set after the first collision, and the transmission of the frame is aborted.
[7]	VF: VLAN Frame	When set, this bit indicates that the transmitted frame is a VLAN-type frame.
[6:3]	Ctrl/status	These status bits indicate the number of collisions that occurred before the frame was transmitted. This count is not valid when the Excessive Collisions bit (TDES0[8]) is set. The core updates this status field only in the half-duplex mode.
[2]	ED: Excessive Deferral	When set, this bit indicates that the transmission has ended because of excessive deferral of over 24,288 bit times (if Jumbo Frame is enabled) if bit EMACDEFERRAL of EMACCONFIG_REG is set high.
[1]	UF: Underflow Error	When set, this bit indicates that the MAC aborted the frame because the data arrived late from the Host memory. Underflow Error indicates that the DMA encountered an empty transmit buffer while transmitting the frame. The transmission process enters the Suspended state and sets both Bit[5] in Transmit Underflow Register (Status Register) and Bit[0] in Transmit Interrupt Register (Status Register).
[0]	DB: Deferred Bit	When set, this bit indicates that the MAC defers before transmission because of the presence of a carrier. This bit is valid only in the half-duplex mode.

**Table 10-6. Transmit Descriptor 1 (TDES1)**

Bits	Name	Description
[31:29]	SAIC: SA Insertion Control	<p>These bits request the MAC to add or replace the Source Address field in the Ethernet frame with the value given in the MAC Address 0 register. If the Source Address field is modified in a frame, the MAC automatically recalculates and replaces the CRC bytes. The Bit[31] specifies the MAC Address Register value (1 or 0) that is used for Source Address insertion or replacement. The following list describes the values of Bits[30:29]:</p> <ul style="list-style-type: none"> <li>• 2'b00: Do not include the source address.</li> <li>• 2'b01: Include or insert the source address. For reliable transmission, the application must provide frames without source addresses.</li> <li>• 2'b10: Replace the source address. For reliable transmission, the application must provide frames with source addresses.</li> <li>• 2'b11: Reserved</li> </ul> <p>These bits are valid when the First Segment control bit (TDES0[28]) is set.</p>
[28:16]	Reserved	Reserved
[15:13]	Reserved	Reserved
[12:0]	TBS1: Transmit Buffer 1 Size	These bits indicate the data buffer byte size in bytes. If this field is 0, the DMA ignores this buffer and uses Buffer 2 or the next descriptor.

**Table 10-7. Transmit Descriptor 2 (TDES2)**

Bits	Name	Description
[31:0]	Buffer 1 Address Pointer	These bits indicate the physical address of Buffer 1.

**Table 10-8. Transmit Descriptor 3 (TDES3)**

Bits	Name	Description
[31:0]	Next Descriptor Address	This address contains the pointer to the physical memory where the Next Descriptor is present.

**Table 10-9. Transmit Descriptor 6 (TDES6)**

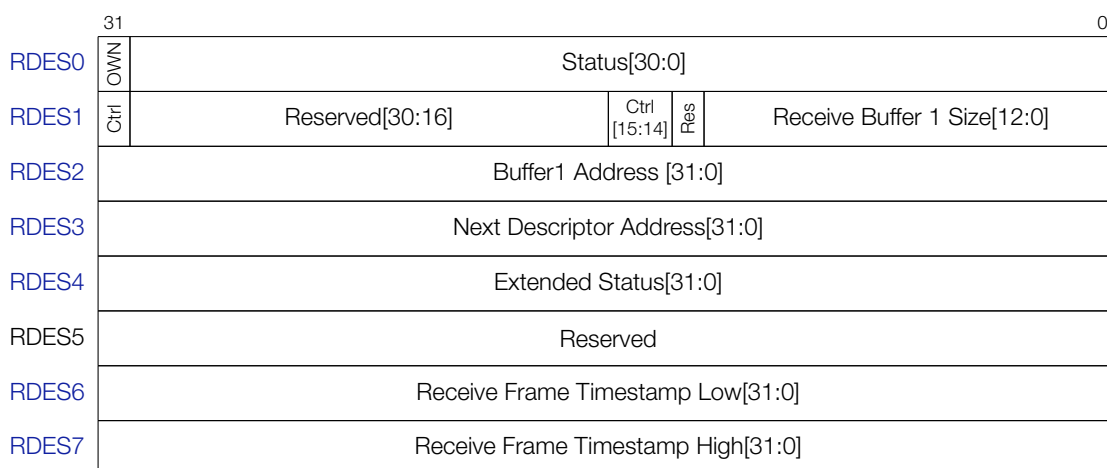
Bits	Name	Description
[31:0]	TTSL: Transmit Frame Timestamp Low	This field is updated by DMA with the least significant 32 bits of the timestamp captured for the corresponding transmit frame. This field has the timestamp only if the Last Segment (LS) bit in the descriptor is set, and the Timestamp Status (TTSS) bit is set too.

**Table 10-10. Transmit Descriptor 7 (TDES7)**

Bits	Name	Description
[31:0]	TTSH: Transmit Frame Timestamp High	This field is updated by DMA with the most significant 32 bits of the timestamp captured for the corresponding receive frame. This field has the timestamp only if the Last Segment (LS) bit in the descriptor is set, and the Timestamp Status (TTSS) bit is set too.

## 10.8.2 Receive Descriptors

The structure of the receiver linked lists is shown in Figure 10-10. Table 10-11 to Table 10-17 provide the description of the linked lists.

**Figure 10-10. Receive Descriptor****Table 10-11. Receive Descriptor 0 (RDES0)**

Bits	Name	Description
[31]	OWN: Own Bit	When set, this bit indicates that the descriptor is owned by the DMA of the DWC_gmac. When this bit is reset, it indicates that the descriptor is owned by the Host. The DMA clears this bit either when it completes the frame reception or when the buffers that are associated with this descriptor are full.
[30]	AFM: Destination Address Filter Fail	When set, this bit indicates a frame that failed in the DA Filter in the MAC.
[29:16]	FL: Frame Length	These bits indicate the byte length of the received frame that was transmitted to host memory. This field is valid when Last Descriptor (RDES0[8]) is set and either the Descriptor Error (RDES0[14]) or Overflow Error bits is reset. The frame length also includes the two bytes appended to the Ethernet frame when IP checksum calculation (Type 1) is enabled and the received frame is not a MAC control frame.



Bits	Name	Description
[15]	ES: Error Summary	<p>Indicates the logical OR of the following bits:</p> <ul style="list-style-type: none"> <li>• RDES0[1]: CRC Error</li> <li>• RDES0[3]: Receive Error</li> <li>• RDES0[4]: Watchdog Timeout</li> <li>• RDES0[6]: Late Collision</li> <li>• RDES0[7]: Giant Frame</li> <li>• RDES4[4:3]: IP Header or Payload Error</li> <li>• RDES0[11]: Overflow Error</li> <li>• RDES0[14]: Descriptor Error</li> </ul> <p>This field is valid only when the Last Descriptor (RDES0[8]) is set.</p>
[14]	DE: Descriptor Error	<p>When set, this bit indicates a frame truncation caused by a frame that does not fit within the current descriptor buffers, and that the DMA does not own the Next Descriptor. The frame is truncated. This field is valid only when the Last Descriptor (RDES0[8]) is set.</p>
[13]	SAF: Source Address Filter Fail	<p>When set, this bit indicates that the SA field of frame failed the SA Filter in the MAC.</p>
[12]	LE: Length Error	<p>When set, this bit indicates that the actual length of the frame received and that the Length/Type field does not match. This bit is valid only when the Frame Type (RDES0[5]) bit is reset.</p>
[11]	OE: Overflow Error	<p>When set, this bit indicates that the received frame was damaged because of buffer overflow in MTL.</p>
[10]	VLAN: VLAN Tag	<p>When set, this bit indicates that the frame to which this descriptor is pointing is a VLAN frame tagged by the MAC. The VLAN tagging depends on checking the VLAN fields of the received frame based on the Register (VLAN Tag Register) settings.</p>
[9]	FS: First Descriptor	<p>When set, this bit indicates that this descriptor contains the first buffer of the frame. If the size of the first buffer is 0, the second buffer contains the beginning of the frame. If the size of the second buffer is also 0, the next Descriptor contains the beginning of the frame.</p>
[8]	LS: Last Descriptor	<p>When set, this bit indicates that the buffers pointed to by this descriptor are the last buffers of the frame.</p>

Bits	Name	Description
[7]	Timestamp Available, IP Checksum Error (Type1), or Giant Frame	<p>When the Advanced Timestamp feature is present, and when this bit set, it indicates that a snapshot of the Timestamp is written in descriptor words 6 (RDES6) and 7 (RDES7). This is valid only when the Last Descriptor bit (RDES0[8]) is set.</p> <p>When IP Checksum Engine (Type 1) is selected, this bit, if set, indicates one of the following:</p> <ul style="list-style-type: none"> <li>• The 16-bit IPv4 header checksum calculated by the core did not match the received checksum bytes.</li> <li>• The header checksum checking is bypassed for non-IPv4 frames.</li> </ul> <p>Otherwise, this bit, when set, indicates the Giant Frame Status. Giant frames are larger than 1,518 bytes (or 1,522 bytes for VLAN or 2,000 bytes when Bit[27] of the MAC Configuration register is set), normal frames and larger-than-9,018-byte (9,022-byte for VLAN) frames when Jumbo Frame processing is enabled.</p>
[6]	LC: Late Collision	When set, this bit indicates that a late collision has occurred while receiving the frame in the half-duplex mode.
[5]	FT: Frame Type	When set, this bit indicates that the Receive Frame is an Ethernet-type frame (the LT field is greater than, or equal to, 1,536). When this bit is reset, it indicates that the received frame is an IEEE 802.3 frame. This bit is not valid for Runt frames which are less than 14 bytes.
[4]	RWT: Receive Watchdog Timeout	When set, this bit indicates that the Receive Watchdog Timer has expired while receiving the current frame and the current frame is truncated after the Watchdog Timeout.
[3]	RE: Receive Error	When set, this bit indicates that the MII_RXER signal is asserted while MII_RXDV is asserted during frame reception.
[2]	DE: Dribble Bit Error	When set, this bit indicates that the received frame has a non-integer multiple of bytes (odd nibbles). This bit is valid only in the MII Mode.
[1]	CE: CRC Error	When set, this bit indicates that a Cyclic Redundancy Check (CRC) Error occurred on the received frame. This field is valid only when the Last Descriptor (RDES0[8]) is set.
[0]	Extended Status Available/Rx MAC Address	<p>When either Advanced Timestamp or IP Checksum Offload (Type 2) is present, this bit, when set, indicates that the extended status is available in descriptor word 4 (RDES4). This is valid only when the Last Descriptor bit (RDES0[8]) is set. This bit is invalid when Bit 30 is set.</p> <p>When IP Checksum Offload (Type 2) is present, this bit is set even when the IP Checksum Offload engine bypasses the processing of the received frame. The bypassing may be because of a non-IP frame or an IP frame with a non-TCP/UDP/ICMP payload.</p>

Bits	Name	Description
		When the Advance Timestamp Feature or the IPC Full Offload is not selected, this bit indicates an Rx MAC Address status. When set, this bit indicates that the Rx MAC Address registers value (1 to 15) matched the frame's DA field. When reset, this bit indicates that the Rx MAC Address Register 0 value matched the DA field.

**Table 10-12. Receive Descriptor 1 (RDES1)**

Bits	Name	Description
[31]	Ctrl	When set, this bit prevents setting the Status Register's RI bit (CSR5[6]) for the received frame that ends in the buffer indicated by this descriptor. This, in turn, disables the assertion of the interrupt to Host because of the RI for that frame.
[30:29]	Reserved	Reserved
[28:16]	Reserved	Reserved
[15]	RER: Receive End of Ring	When set, this bit indicates that the descriptor list reached its final descriptor. The DMA returns to the base address of the list, creating a Descriptor Ring.
[14]	RCH: Second Address Chained	When set, this bit indicates that the second address in the descriptor is the Next Descriptor address rather than the second buffer address. When this bit is set, RBS2 (RDES1[28:16]) is a "don't care" value. RDES1[15] takes precedence over RDES1[14].
[13]	Reserved	Reserved
[12:0]	RBS1: Receive Buffer 1 Size	Indicates the first data buffer size in bytes. The buffer size must be a multiple of 4, even if the value of RDES2 (buffer1 address pointer) is not aligned to bus width. When the buffer size is not a multiple of 4, the resulting behavior is undefined. If this field is 0, the DMA ignores this buffer and uses Buffer 2 or the next descriptor depending on the value of RCH (Bit[14]).

**Table 10-13. Receive Descriptor 2 (RDES2)**

Bits	Name	Description
[31:0]	Buffer 1 Address Pointer	These bits indicate the physical address of Buffer 1.

**Table 10-14. Receive Descriptor 3 (RDES3)**

Bits	Name	Description
[31:0]	Next Descriptor Address	This address contains the pointer to the physical memory where the Next Descriptor is present.

Table 10-15. Receive Descriptor 4 (RDES4)

Bits	Name	Description
[31:28]	Reserved	Reserved
[27:26]	Reserved	Reserved
[25]	Reserved	Reserved
[24]	Reserved	Reserved
[23:21]	Reserved	Reserved
[20:18]	Reserved	Reserved
[17]	Reserved	Reserved
[16]	Reserved	Reserved
[15]	Reserved	Reserved
[14]	Timestamp Dropped	When set, this bit indicates that the timestamp was captured for this frame but got dropped in the MTL Rx FIFO because of an overflow.
[13]	PTP Version	When set, this bit indicates that the received PTP message is having the IEEE 1588 version 2 format. When reset, it has the version 1 format.
[12]	PTP Frame Type	When set, this bit indicates that the PTP message is sent directly over the Ethernet. When this bit is not set and the message type is non-zero, it indicates that the PTP message is sent over UDP-IPv4 or UDP-IPv6. The information about IPv4 or IPv6 can be obtained from Bits 6 and 7.
[11:8]	Message Type	These bits are encoded to give the type of the message received. <ul style="list-style-type: none"> <li>• 3'b0000: No PTP message received</li> <li>• 3'b0001: SYNC (all clock types)</li> <li>• 3'b0010: Follow_Up (all clock types)</li> <li>• 3'b0011: Delay_Req (all clock types)</li> <li>• 3'b0100: Delay_Resp (all clock types)</li> <li>• 3'b0101: Pdelay_Req (in peer-to-peer transparent clock)</li> <li>• 3'b0110: Pdelay_Resp (in peer-to-peer transparent clock)</li> <li>• 3'b0111: Pdelay_Resp_Follow_Up (in peer-to-peer transparent clock)</li> <li>• 3'b1000: Announce</li> <li>• 3'b1001: Management</li> <li>• 3'b1010: Signaling</li> <li>• 3'b1011-3'b1110: Reserved</li> <li>• 3'b1111: PTP packet with Reserved message type</li> </ul>
[7]	IPv6 Packet Received	When set, this bit indicates that the received packet is an IPv6 packet. This bit is updated only when Bit[10] (IPC) of Register (MAC Configuration Register) is set.
[6]	IPv4 Packet Received	When set, this bit indicates that the received packet is an IPv4 packet. This bit is updated only when Bit[10] (IPC) of Register (MAC Configuration Register) is set.
[5]	IP Checksum Bypassed	When set, this bit indicates that the checksum offload engine is bypassed.

Bits	Name	Description
[4]	IP Payload Error	When set, this bit indicates that the 16-bit IP payload checksum (that is, the TCP, UDP, or ICMP checksum) that the core calculated does not match the corresponding checksum field in the received segment. It is also set when the TCP, UDP, or ICMP segment length does not match the payload length value in the IP Header field. This bit is valid when either Bit 7 or Bit 6 is set.
[3]	IP Header Error	When set, this bit indicates that either the 16-bit IPv4 header checksum calculated by the core does not match the received checksum bytes, or the IP datagram version is not consistent with the Ethernet Type value. This bit is valid when either Bit[7] or Bit[6] is set.
[2:0]	IP Payload Type	These bits indicate the type of payload encapsulated in the IP datagram processed by the Receive Checksum Offload Engine (COE). The COE also sets these bits to 2'b00 if it does not process the IP datagram's payload due to an IP header error or fragmented IP. <ul style="list-style-type: none"> <li>• 3'b000: Unknown or did not process IP payload</li> <li>• 3'b001: UDP</li> <li>• 3'b010: TCP</li> <li>• 3'b011: ICMP</li> <li>• 3'b1xx: Reserved</li> </ul> This bit is valid when either Bit[7] or Bit[6] is set.

**Table 10-16. Receive Descriptor 6 (RDES6)**

Bits	Name	Description
[31:0]	RTSH: Receive Frame Timestamp Low	This field is updated by DMA with the least significant 32 bits of the timestamp captured for the corresponding receive frame. This field is updated by DMA only for the last descriptor of the receive frame which is indicated by the Last Descriptor status bit (RDES0[8]).

**Table 10-17. Receive Descriptor 7 (RDES7)**

Bits	Name	Description
[31:0]	RTSH: Receive Frame Timestamp High	This field is updated by DMA with the most significant 32 bits of the timestamp captured for the corresponding receive frame. This field is updated by DMA only for the last descriptor of the receive frame which is indicated by the Last Descriptor status bit (RDES0[8]).

## 10.9 Register Summary

Note that specific fields or bits of a given register may have different access attributes. Below is the list of all attributes together with the abbreviations used in register descriptions.

- Read Only (RO)
- Write Only (WO)

- Read and Write (R/W)
- Read, Write, and Self Clear (R/W/SC)
- Read, Self Set, and Write Clear (R/SS/WC)
- Read, Write Set, and Self Clear (R/WS/SC)
- Read, Self Set, and Self Clear or Write Clear (R/SS/SC/WC)
- Read Only and Write Trigger (RO/WT)
- Read, Self Set, and Read Clear (R/SS/RC)
- Read, Write, and Self Update (R/W/SU)
- Latched-low (LL)
- Latched-high (LH)

Name	Description	Address	Access
<b>DMA configuration and control registers</b>			
DMABUSMODE_REG	Bus mode configuration	0x3FF69000	R/WS/SC
DMATXPOLLDEMAND_REG	Pull demand for data transmit	0x3FF69004	RO/WT
DMARXPOLLDEMAND_REG	Pull demand for data receive	0x3FF69008	RO/WT
DMARXBASEADDR_REG	Base address of the first receive descriptor	0x3FF6900C	R/W
DMATXBASEADDR_REG	Base address of the first transmit descriptor	0x3FF69010	R/W
DMASTATUS_REG	State of interrupts, errors and other events	0x3FF69014	R/SS/WC
DMAOPERATION_MODE_REG	Receive and Transmit operating modes and command	0x3FF69018	R/SS/WC
DMAIN_EN_REG	Enable / disable interrupts	0x3FF6901C	R/W
DMAMISSEDFR_REG	Missed Frame and Buffer Overflow Counter Register	0x3FF69020	R/W
DMARINTWDTIMER_REG	Watchdog timer count on receive	0x3FF69024	R/W
DMATXCURRDESC_REG	Pointer to current transmit descriptor	0x3FF69048	RO
DMARXCURRDESC_REG	Pointer to current receive descriptor	0x3FF6904C	RO
DMATXCURRADDR_BUF_REG	Pointer to current transmit buffer	0x3FF69050	RO
DMARXCURRADDR_BUF_REG	Pointer to current receive buffer	0x3FF69054	RO
<b>MAC configuration and control registers</b>			
EMACCONFIG_REG	MAC configuration	0x3FF6A000	R/W
EMACFF_REG	Frame filter settings	0x3FF6A004	R/W
EMACMIIADDR_REG	PHY configuration access	0x3FF6A010	R/WS/SC
EMACMIIIDATA_REG	PHY data read write	0x3FF6A014	R/W
EMACFC_REG	frame flow control	0x3FF6A018	R/WS/SC(FCB) R/W(BPA)
EMACDEBUG_REG	Status debugging bits	0x3FF6A024	RO
PMT_RWUFR_REG	Remote Wake-Up Frame Filter	0x3FF6A028	RO
PMT_CSR_REG	PMT Control and Status	0x3FF6A02C	RO

Name	Description	Address	Access
EMACLPI_CSR_REG	LPI Control and Status	0x3FF6A030	RO
EMACLPITIMERSCONTROL_REG	LPI Timers Control	0x3FF6A034	RO
EMACINTS_REG	Interrupt status	0x3FF6A038	RO
EMACINTMASK_REG	Interrupt mask	0x3FF6A03C	R/W
EMACADDR0HIGH_REG	Upper 16 bits of the first 6-byte MAC address	0x3FF6A040	R/W
EMACADDR0LOW_REG	Lower 32 bits of the first 6-byte MAC address	0x3FF6A044	R/W
EMACADDR1HIGH_REG	MAC address filtering and upper 16 bits of the second 6-byte MAC address	0x3FF6A048	R/W
EMACADDR1LOW_REG	Lower 32 bits of the second 6-byte MAC address	0x3FF6A04C	R/W
EMACADDR2HIGH_REG	MAC address filtering and upper 16 bits of the third 6-byte MAC address	0x3FF6A050	R/W
EMACADDR2LOW_REG	Lower 32 bits of the third 6-byte MAC address	0x3FF6A054	R/W
EMACADDR3HIGH_REG	MAC address filtering and upper 16 bits of the fourth 6-byte MAC address	0x3FF6A058	R/W
EMACADDR3LOW_REG	Lower 32 bits of the fourth 6-byte MAC address	0x3FF6A05C	R/W
EMACADDR4HIGH_REG	MAC address filtering and upper 16 bits of the fifth 6-byte MAC address	0x3FF6A060	R/W
EMACADDR4LOW_REG	Lower 32 bits of the fifth 6-byte MAC address	0x3FF6A064	R/W
EMACADDR5HIGH_REG	MAC address filtering and upper 16 bits of the sixth 6-byte MAC address	0x3FF6A068	R/W
EMACADDR5LOW_REG	Lower 32 bits of the sixth 6-byte MAC address	0x3FF6A06C	R/W
EMACADDR6HIGH_REG	MAC address filtering and upper 16 bits of the seventh 6-byte MAC address	0x3FF6A070	R/W
EMACADDR6LOW_REG	Lower 32 bits of the seventh 6-byte MAC address	0x3FF6A074	R/W
EMACADDR7HIGH_REG	MAC address filtering and upper 16 bits of the eighth 6-byte MAC address	0x3FF6A078	R/W
EMACADDR7LOW_REG	Lower 32 bits of the eighth 6-byte MAC address	0x3FF6A07C	R/W
EMACCSSTATUS_REG	Link communication status	0x3FF6A0D8	RO
EMACWDOGTO_REG	Watchdog timeout control	0x3FF6A0DC	R/W
<b>Clock configuration registers</b>			
EMAC_EX_CLKOUT_CONF_REG	RMII clock divider setting	0x3FF69800	R/W
EMAC_EX_OSCCLK_CONF_REG	RMII clock half and whole divider settings	0x3FF69804	R/W
EMAC_EX_CLK_CTRL_REG	Clock enable and external / internal clock selection	0x3FF69808	R/W

Name	Description	Address	Access
<b>PHY type and SRAM configuration registers</b>			
<a href="#">EMAC_EX_PHYINF_CONF_REG</a>	Selection of MII / RMII phy	0x3FF6980C	R/W
<a href="#">EMAC_PD_SEL_REG</a>	Ethernet RAM power-down enable	0x3FF69810	R/W

## 10.10 Registers

**Note:** The value of all reset registers must be set to the reset value.



**Register 10.1. DMABUSMODE\_REG (0x0000)**

(reserved)				DMAMIXEDBURST	DMAADDRALIBEA	PBLX8_MODE	USE_SEP_PBL	RX_DMA_PBL	FIXED_BURST	PRI_RATIO	PROG_BURST_LEN	ALT_DESC_SIZE	DESC_SKIP_LEN	DMA_ARB_SCH	SW_RST			
31	27	26	25	24	23	22	17	16	15	14	13	8	7	6	2	1	0	
0	0	0	0	0	0	0	0	0	0	0	0	0	0	0	0	0	1	Reset

**DMAMIXEDBURST** When this bit is set high and the FB(FIXES\_BURST) bit is low, the AHB master interface starts all bursts of a length more than 16 with INCR (undefined burst), whereas it reverts to fixed burst transfers (INCRx and SINGLE) for burst length of 16 and less. (R/W)

**DMAADDRALIBEA** When this bit is set high and the FB bit is 1, the AHB interface generates all bursts aligned to the start address LS bits. If the FB bit is 0, the first burst (accessing the start address of data buffer) is not aligned, but subsequent bursts are aligned to the address. (R/W)

**PBLX8\_MODE** When set high, this bit multiplies the programmed PBL(PROG\_BURST\_LEN) value (Bits[22:17] and Bits[13:8]) eight times. Therefore, the DMA transfers the data in 8, 16, 32, 64, 128, and 256 beats depending on the PBL value. (R/W)

**USE\_SEP\_PBL** When set high, this bit configures the Rx DMA to use the value configured in Bits[22:17] as PBL. The PBL value in Bits[13:8] is applicable only to the Tx DMA operations. When reset to low, the PBL value in Bits[13:8] is applicable for both DMA engines. (R/W)

**RX\_DMA\_PBL** This field indicates the maximum number of beats to be transferred in one Rx DMA transaction. This is the maximum value that is used in a single block Read or Write. The Rx DMA always attempts to burst as specified in the RPBL(RX\_DMA\_PBL) bit each time it starts a burst transfer on the host bus. You can program RPBL with values of 1, 2, 4, 8, 16, and 32. Any other value results in undefined behavior. This field is valid and applicable only when USP(USE\_SEP\_PBL) is set high. (R/W)

**FIXED\_BURST** This bit controls whether the AHB master interface performs fixed burst transfers or not. When set, the AHB interface uses only SINGLE, INCR4, INCR8, or INCR16 during start of the normal burst transfers. When reset, the AHB interface uses SINGLE and INCR burst transfer operations. (R/W)

**PRI\_RATIO** These bits control the priority ratio in the weighted round-robin arbitration between the Rx DMA and Tx DMA. These bits are valid only when Bit 1 (DA) is reset. The priority ratio Rx:Tx represented by each bit: (R/W)

- 2'b00 — 1: 1
- 2'b01 — 2: 0
- 2'b10 — 3: 1
- 2'b11 — 4: 1

Continued on the next page...

**Register 10.1. DMABUSMODE\_REG (0x0000)**

Continued from the previous page...

**PROG\_BURST\_LEN** These bits indicate the maximum number of beats to be transferred in one DMA transaction. If the number of beats to be transferred is more than 32, then perform the following steps: 1. Set the PBLx8 mode; 2. Set the PBL. (R/W)

**ALT\_DESC\_SIZE** When set, the size of the alternate descriptor increases to 32 bytes. (R/W)

**DESC\_SKIP\_LEN** This bit specifies the number of Word to skip between two unchained descriptors. The address skipping starts from the end of current descriptor to the start of next descriptor. When the DSL(DESC\_SKIP\_LEN) value is equal to zero, the descriptor table is taken as contiguous by the DMA in Ring mode. (R/W)

**DMA\_ARB\_SCH** This bit specifies the arbitration scheme between the transmit and receive paths. 1'b0: weighted round-robin with RX: TX or TX: RX, priority specified in PR (bit[15:14]); 1'b1 Fixed priority (Rx priority to Tx). (R/W)

**SW\_RST** When this bit is set, the MAC DMA Controller resets the logic and all internal registers of the MAC. It is cleared automatically after the reset operation is complete in all of the ETH\_MAC clock domains. Before reprogramming any register of the ETH\_MAC, you should read a zero (0) value in this bit. (R/WS/SC)

**Register 10.2. DMATXPOLLDEMAND\_REG (0x0004)**

31	0
0x00000000	
Reset	

**TRANS\_POLL\_DEMAND** When these bits are written with any value, the DMA reads the current descriptor to which the Register (Current Host Transmit Descriptor Register) is pointing. If that descriptor is not available (owned by the Host), the transmission returns to the suspend state and Bit[2] (TU) of Status Register is asserted. If the descriptor is available, the transmission resumes. (RO/WT)

**Register 10.3. DMARXPOLLDEMAND\_REG (0x0008)**

31	0
0x00000000	
Reset	

**RECV\_POLL\_DEMAND** When these bits are written with any value, the DMA reads the current descriptor to which the Current Host Receive Descriptor Register is pointing. If that descriptor is not available (owned by the Host), the reception returns to the Suspended state and Bit[7] (RU) of Status Register is asserted. If the descriptor is available, the Rx DMA returns to the active state. (RO/WT)

**Register 10.4. DMARXBASEADDR\_REG (0x000C)**

31	0
0x00000000	

Reset

**START\_RECV\_LIST** This field contains the base address of the first descriptor in the Receive Descriptor list. The LSB Bits[1:0] are ignored and internally taken as all-zero by the DMA. Therefore, these LSB bits are read-only. (R/W)

**Register 10.5. DMATXBASEADDR\_REG (0x0010)**

31	0
0x00000000	

Reset

**START\_TRANS\_LIST** This field contains the base address of the first descriptor in the Transmit Descriptor list. The LSB Bits[1:0] are ignored and are internally taken as all-zero by the DMA. Therefore, these LSB bits are read-only. (R/W)

**Register 10.6. DMASTATUS\_REG (0x0014)**

31	30	29	28	27	26	25	23	22	20	19	17	16	15	14	13	12	11	10	9	8	7	6	5	4	3	2	1	0															
(reserved)		TS_TRI_INT		EMAC_PMT_INT		(reserved)		ERROR_BITS		TRANS_PROC_STATE		RECV_PROC_STATE		NORM_INT_SUMM		ABN_INT_SUMM		EARLY_RECV_INT		FATAL_BUS_ERR_INT		(reserved)		EARLY_TRANS_INT		RECV_WDT_TO		RECV_PROC_STOP		RECV_BUF_UNAVAIL		TRANS_UNDFLOW		RECV_OVERFLOW		TRANS_JABBER_TO		TRANS_BUF_UNAVAIL		TRANS_PROC_STOP		TRANS_INT	
0		0		0		0		0		0x0		0x0		0x0		0		0		0		0		0		0		0		0		0		0		0		0		0			

Reset

**TS\_TRI\_INT** This bit indicates an interrupt event in the Timestamp Generator block of the ETH\_MAC. The software must read the corresponding registers in the ETH\_MAC to get the exact cause of the interrupt and clear its source to reset this bit to 1'b0. (RO)

**EMAC\_PMT\_INT** This bit indicates an interrupt event in the PMT module of the ETH\_MAC. The software must read the PMT Control and Status Register in the MAC to get the exact cause of interrupt and clear its source to reset this bit to 1'b0. (RO)

Continued on the next page...

**Register 10.6. DMASTATUS\_REG (0x0014)**

**Continued from the previous page...**

**ERROR\_BITS** This field indicates the type of error that caused a Bus Error, for example, error response on the AHB interface. This field is valid only when Bit[13] (FBI) is set. This field does not generate an interrupt. (RO)

- 3'b000: Error during Rx DMA Write Data Transfer.
- 3'b011: Error during Tx DMA Read Data Transfer.
- 3'b100: Error during Rx DMA Descriptor Write Access.
- 3'b101: Error during Tx DMA Descriptor Write Access.
- 3'b110: Error during Rx DMA Descriptor Read Access.
- 3'b111: Error during Tx DMA Descriptor Read Access.

**TRANS\_PROC\_STATE** This field indicates the Transmit DMA FSM state. This field does not generate an interrupt. (RO)

- 3'b000: Stopped. Reset or Stop Transmit Command issued.
- 3'b001: Running. Fetching Transmit Transfer Descriptor.
- 3'b010: Reserved for future use.
- 3'b011: Running. Waiting for TX packets.
- 3'b100: Suspended. Receive Descriptor Unavailable.
- 3'b101: Running. Closing Transmit Descriptor.
- 3'b110: TIME\_STAMP write state.
- 3'b111: Running. Transferring the TX packets data from transmit buffer to host memory.

**RECV\_PROC\_STATE** This field indicates the Receive DMA FSM state. This field does not generate an interrupt. (RO)

- 3'b000: Stopped. Reset or Stop Receive Command issued.
- 3'b001: Running. Fetching Receive Transfer Descriptor.
- 3'b010: Reserved for future use.
- 3'b011: Running. Waiting for RX packets.
- 3'b100: Suspended. Receive Descriptor Unavailable.
- 3'b101: Running. Closing Receive Descriptor.
- 3'b110: TIME\_STAMP write state.
- 3'b111: Running. Transferring the TX packets data from receive buffer to host memory.

**Continued on the next page...**

**Register 10.6. DMASTATUS\_REG (0x0014)**

**Continued from the previous page...**

**NORM\_INT\_SUMM** Normal Interrupt Summary bit value is the logical OR of the following bits when the corresponding interrupt bits are enabled in Interrupt Enable Register: (R/SS/WC)

- Bit[0]: Transmit Interrupt.
- Bit[2]: Transmit Buffer Unavailable.
- Bit[6]: Receive Interrupt.
- Bit[14]: Early Receive Interrupt. Only unmasked bits affect the Normal Interrupt Summary bit. This is a sticky bit and must be cleared (by writing 1 to this bit) each time a corresponding bit, which causes NIS to be set, is cleared.

**ABN\_INT\_SUMM** Abnormal Interrupt Summary bit value is the logical OR of the following when the corresponding interrupt bits are enabled in Interrupt Enable Register: (R/SS/WC)

- Bit[1]: Transmit Process Stopped.
- Bit[3]: Transmit Jabber Timeout.
- Bit[4]: Receive FIFO Overflow.
- Bit[5]: Transmit Underflow.
- Bit[7]: Receive Buffer Unavailable. Bit[8]: Receive Process Stopped.
- Bit[9]: Receive Watchdog Timeout.
- Bit[10]: Early Transmit Interrupt.
- Bit[13]: Fatal Bus Error. Only unmasked bits affect the Abnormal Interrupt Summary bit. This is a sticky bit and must be cleared (by writing 1 to this bit) each time a corresponding bit, which causes AIS to be set, is cleared.

**EARLY\_RECV\_INT** This bit indicates that the DMA filled the first data buffer of the packet. This bit is cleared when the software writes 1 to this bit or when Bit[6] (RI) of this register is set (whichever occurs earlier). (R/SS/WC)

**FATAL\_BUS\_ERR\_INT** This bit indicates that a bus error occurred, as described in Bits [25:23]. When this bit is set, the corresponding DMA engine disables all of its bus accesses. (R/SS/WC)

**EARLY\_TRANS\_INT** This bit indicates that the frame to be transmitted is fully transferred to the MTL Transmit FIFO. (R/SS/WC)

**RECV\_WDT\_TO** When set, this bit indicates that the Receive Watchdog Timer expired while receiving the current frame and the current frame is truncated after the watchdog timeout. (R/SS/WC)

**Continued on the next page...**

**Register 10.6. DMASTATUS\_REG (0x0014)**

Continued from the previous page...

**RECV\_PROC\_STOP** This bit is asserted when the Receive Process enters the Stopped state. (R/SS/WC)

**RECV\_BUF\_UNAVAIL** This bit indicates that the host owns the Next Descriptor in the Receive List and the DMA cannot acquire it. The Receive Process is suspended. To resume processing Receive descriptors, the host should change the ownership of the descriptor and issue a Receive Poll Demand command. If no Receive Poll Demand is issued, the Receive Process resumes when the next recognized incoming frame is received. This bit is set only when the previous Receive Descriptor is owned by the DMA. (R/SS/WC)

**RECV\_INT** This bit indicates that the frame reception is complete. When reception is complete, the Bit[31] of RDES1 (Disable Interrupt on Completion) is reset in the last Descriptor, and the specific frame status information is updated in the descriptor. The reception remains in the Running state. (R/SS/WC)

**TRANS\_UNDFLOW** This bit indicates that the Transmit Buffer had an Underflow during frame transmission. Transmission is suspended and an Underflow Error TDES0[1] is set. (R/SS/WC)

**RECV\_OVFLOW** This bit indicates that the Receive Buffer had an Overflow during frame reception. If the partial frame is transferred to the application, the overflow status is set in RDES0[11]. (R/SS/WC)

**TRANS\_JABBER\_TO** This bit indicates that the Transmit Jabber Timer expired, which happens when the frame size exceeds 2,048 (10,240 bytes when the Jumbo frame is enabled). When the Jabber Timeout occurs, the transmission process is aborted and placed in the Stopped state. This causes the Transmit Jabber Timeout TDES0[14] flag to assert. (R/SS/WC)

**TRANS\_BUF\_UNAVAIL** This bit indicates that the host owns the Next Descriptor in the Transmit List and the DMA cannot acquire it. Transmission is suspended. Bits[22:20] explain the Transmit Process state transitions. To resume processing Transmit descriptors, the host should change the ownership of the descriptor by setting TDES0[31] and then issue a Transmit Poll Demand command. (R/SS/WC)

**TRANS\_PROC\_STOP** This bit is set when the transmission is stopped. (R/SS/WC)

**TRANS\_INT** This bit indicates that the frame transmission is complete. When transmission is complete, Bit[31] (OWN) of TDES0 is reset, and the specific frame status information is updated in the descriptor. (R/SS/WC)

**Register 10.7. DMAOPERATION\_MODE\_REG (0x0018)**

(reserved)	(reserved)	DIS_DROP_TCPIP_ERR_FRAM	RX_STORE_FORWARD	DIS_FLUSH_RECV_FRAMES	(reserved)	(reserved)	TX_STR_FWD	FLUSH_TX_FIFO	(reserved)	TX_THRESH_CTRL	START_STOP_TRANSMISSION_COMMAND	(reserved)	(reserved)	(reserved)	FWD_ERR_FRAME	FWD_UNDER_GF	DROP_GFRM	RX_THRESH_CTRL	OPT_SECOND_FRAME	START_STOP_RX	(reserved)						
31	27	26	25	24	23	22	21	20	19	17	16	14	13	12	11	10	9	8	7	6	5	4	3	2	1	0	Reset
0	0	0	0	0	0	0	0	0	0	0	0	0	0	0	0	0	0	0	0	0	0	0	0	0	0	0	0

**DIS\_DROP\_TCPIP\_ERR\_FRAM** When this bit is set, the MAC does not drop the frames which only have errors detected by the Receive Checksum engine. When this bit is reset, all error frames are dropped if the Fwd\_Err\_Frame bit is reset. (R/W)

**RX\_STORE\_FORWARD** When this bit is set, the MTL reads a frame from the Rx FIFO only after the complete frame has been written to it. (R/W)

**DIS\_FLUSH\_RECV\_FRAMES** When this bit is set, the Rx DMA does not flush any frames because of the unavailability of receive descriptors or buffers. (R/W)

**TX\_STR\_FWD** When this bit is set, transmission starts when a full frame resides in the MTL Transmit FIFO. When this bit is set, the TX\_THRESH\_CTRL values specified in TX\_THRESH\_CTRL are ignored. (R/W)

**FLUSH\_TX\_FIFO** When this bit is set, the transmit FIFO controller logic is reset to its default values and thus all data in the Tx FIFO is lost or flushed. This bit is cleared internally when the flushing operation is complete. (R/WS/SC)

**TX\_THRESH\_CTRL** These bits control the threshold level of the MTL Transmit FIFO. Transmission starts when the frame size within the MTL Transmit FIFO is larger than the threshold. In addition, full frames with a length less than the threshold are also transmitted. These bits are used only when TX\_STR\_FWD is reset. 3'b000: 64, 3'b001: 128, 3'b010: 192, 3'b011: 256, 3'b100: 40, 3'b101: 32, 3'b110: 24, 3'b111: 16. (R/W)

**START\_STOP\_TRANSMISSION\_COMMAND** When this bit is set, transmission is placed in the Running state, and the DMA checks the Transmit List at the current position for a frame to be transmitted. When this bit is reset, the transmission process is placed in the Stopped state after completing the transmission of the current frame. (R/W)

**FWD\_ERR\_FRAME** When this bit is reset, the Rx FIFO drops frames with error status (CRC error, collision error, giant frame, watchdog timeout, or overflow). (R/W)

**FWD\_UNDER\_GF** When set, the Rx FIFO forwards Undersized frames (that is, frames with no Error and length less than 64 bytes) including pad-bytes and CRC.

**DROP\_GFRM** When set, the MAC drops the received giant frames in the Rx FIFO, that is, frames that are larger than the computed giant frame limit. (R/W)

Continued on the next page...

**Register 10.7. DMAOPERATION\_MODE\_REG (0x0018)**

Continued from the previous page...

**RX\_THRESH\_CTRL** These two bits control the threshold level of the MTL Receive FIFO. Transfer (request) to DMA starts when the frame size within the MTL Receive FIFO is larger than the threshold. 2'b00: 64; 2'b01: 32; 2'b10: 96; 2'b11: 128. (R/W)

**OPT\_SECOND\_FRAME** When this bit is set, it instructs the DMA to process the second frame of the Transmit data even before the status for the first frame is obtained. (R/W)

**START\_STOP\_RX** When this bit is set, the Receive process is placed in the Running state. The DMA attempts to acquire the descriptor from the Receive list and processes the incoming frames. When this bit is cleared, the Rx DMA operation is stopped after the transfer of the current frame. (R/W)





**Register 10.8. DMAIN\_EN\_REG (0x001C)**

Continued from the previous page...

**DMAIN\_FBEE** When this bit is set with Abnormal Interrupt Summary Enable (Bit[15]), the Fatal Bus Error Interrupt is enabled. When this bit is reset, the Fatal Bus Error Enable Interrupt is disabled. (R/W)

**DMAIN\_ETIE** When this bit is set with an Abnormal Interrupt Summary Enable (Bit[15]), the Early Transmit Interrupt is enabled. When this bit is reset, the Early Transmit Interrupt is disabled. (R/W)

**DMAIN\_RWTE** When this bit is set with Abnormal Interrupt Summary Enable (Bit[15]), the Receive Watchdog Timeout Interrupt is enabled. When this bit is reset, the Receive Watchdog Timeout Interrupt is disabled. (R/W)

**DMAIN\_RSE** When this bit is set with Abnormal Interrupt Summary Enable (Bit[15]), the Receive Stopped Interrupt is enabled. When this bit is reset, the Receive Stopped Interrupt is disabled. (R/W)

**DMAIN\_RBUE** When this bit is set with Abnormal Interrupt Summary Enable (Bit[15]), the Receive Buffer Unavailable Interrupt is enabled. When this bit is reset, the Receive Buffer Unavailable Interrupt is disabled. (R/W)

**DMAIN\_RIE** When this bit is set with Normal Interrupt Summary Enable (Bit[16]), the Receive Interrupt is enabled. When this bit is reset, the Receive Interrupt is disabled. (R/W)

**DMAIN\_UIE** When this bit is set with Abnormal Interrupt Summary Enable (Bit[15]), the Transmit Underflow Interrupt is enabled. When this bit is reset, the Underflow Interrupt is disabled. (R/W)

**DMAIN\_OIE** When this bit is set with Abnormal Interrupt Summary Enable (Bit[15]), the Receive Overflow Interrupt is enabled. When this bit is reset, the Overflow Interrupt is disabled. (R/W)

**DMAIN\_TJTE** When this bit is set with Abnormal Interrupt Summary Enable (Bit[15]), the Transmit Jabber Timeout Interrupt is enabled. When this bit is reset, the Transmit Jabber Timeout Interrupt is disabled. (R/W)

**DMAIN\_TBUE** When this bit is set with Normal Interrupt Summary Enable (Bit 16), the Transmit Buffer Unavailable Interrupt is enabled. When this bit is reset, the Transmit Buffer Unavailable Interrupt is disabled. (R/W)

**DMAIN\_TSE** When this bit is set with Abnormal Interrupt Summary Enable (Bit[15]), the Transmission Stopped Interrupt is enabled. When this bit is reset, the Transmission Stopped Interrupt is disabled. (R/W)

**DMAIN\_TIE** When this bit is set with Normal Interrupt Summary Enable (Bit[16]), the Transmit Interrupt is enabled. When this bit is reset, the Transmit Interrupt is disabled. (R/W)

**Register 10.9. DMAMISSEDFR\_REG (0x0020)**

(reserved)		Overflow_BFOC		Overflow_FC				Overflow_BMFC			Missed_FC		
30	29	28	27					17	16	10			0
0	0	0x0		0x0				0x0			0x0		Reset

**Overflow\_BFOC** This bit is set every time the Overflow Frame Counter (Bits[27:17]) overflows, that is, the Rx FIFO overflows with the overflow frame counter at maximum value. In such a scenario, the overflow frame counter is reset to all-zeros and this bit indicates that the rollover happened. (R/SS/RC)

**Overflow\_FC** This field indicates the number of frames missed by the application. This counter is incremented each time the MTL FIFO overflows. The counter is cleared when this register is read. (R/SS/RC)

**Overflow\_BMFC** This bit is set every time Missed Frame Counter (Bits[15:0]) overflows, that is, the DMA discards an incoming frame because of the Host Receive Buffer being unavailable with the missed frame counter at maximum value. In such a scenario, the Missed frame counter is reset to all-zeros and this bit indicates that the rollover happened. (R/SS/RC)

**Missed\_FC** This field indicates the number of frames missed by the controller because of the Host Receive Buffer being unavailable. This counter is incremented each time the DMA discards an incoming frame. The counter is cleared when this register is read. (R/SS/RC)

**Register 10.10. DMARINTWDTIMER\_REG (0x0024)**

(reserved)															RIWTC				
31														8	7			0	
0	0	0	0	0	0	0	0	0	0	0	0	0	0	0	0	0	0	0x000	Reset

**RIWTC** This bit indicates the number of system clock cycles multiplied by 256 for which the watchdog timer is set. The watchdog timer gets triggered with the programmed value after the Rx DMA completes the transfer of a frame for which the RI (RECV\_INT) status bit is not set because of the setting in the corresponding descriptor RDES1[31]. When the watchdog timer runs out, the RI bit is set and the timer is stopped. The watchdog timer is reset when the RI bit is set high because of automatic setting of RI as per RDES1[31] of any received frame. (R/W)

**Register 10.11. DMATXCURRDESC\_REG (0x0048)**

31	0
0x00000000	

Reset

**TRANS\_DSCR\_ADDR\_PTR** The address of the current receive descriptor list. Cleared on Reset.  
 Pointer updated by the DMA during operation. (RO)

**Register 10.12. DMARXCURRDESC\_REG (0x004C)**

31	0
0x00000000	

Reset

**RECV\_DSCR\_ADDR\_PTR** The address of the current receive descriptor list. Cleared on Reset.  
 Pointer updated by the DMA during operation. (RO)

**Register 10.13. DMATXCURRADDR\_BUF\_REG (0x0050)**

31	0
0x00000000	

Reset

**TRANS\_BUFF\_ADDR\_PTR** The address of the current receive descriptor list. Cleared on Reset.  
 Pointer updated by the DMA during operation. (RO)

**Register 10.14. DMARXCURRADDR\_BUF\_REG (0x0054)**

31	0
0x00000000	

Reset

**RECV\_BUFF\_ADDR\_PTR** The address of the current receive descriptor list. Cleared on Reset.  
 Pointer updated by the DMA during operation. (RO)

**Register 10.15. EMACCONFIG\_REG (0x1000)**

(reserved)	SAIRC	ASS2KP	(reserved)	EMACWATCHDOG	EMACJABBER	(reserved)	EMACJUMBOFRAME	EMACINTERFRAMEGAP	EMACDISABLECRS	EMACMII	EMACFESPEED	EMACRYOWIN	EMACLOOPBACK	EMACRXIPCOFFLOAD	(reserved)	EMACPADCRICSTRIP	EMACBACKOFFLIMIT	EMACTX	EMACRX	PLTF									
31	30	28	27	26	24	23	22	21	20	19	17	16	15	14	13	12	11	10	9	8	7	6	5	4	3	2	1	0	
0	0x0	0	0	0	0	0	0	0	0	0	0	0	0	0	0	0	0	0	0	0	0	0x0	0	0	0	0	0	0x0	Reset

**SAIRC** This field controls the source address insertion or replacement for all transmitted frames. Bit[30] specifies which MAC Address register (0 or 1) is used for source address insertion or replacement based on the values of Bits [29:28]: (R/W)

- 2'b0x: The input signals mti\_sa\_ctrl\_i and ati\_sa\_ctrl\_i control the SA field generation.
- 2'b10: If Bit[30] is set to 0, the MAC inserts the content of the MAC Address 0 registers in the SA field of all transmitted frames. If Bit[30] is set to 1 the MAC inserts the content of the MAC Address 1 registers in the SA field of all transmitted frames.
- 2'b11: If Bit[30] is set to 0, the MAC replaces the content of the MAC Address 0 registers in the SA field of all transmitted frames. If Bit[30] is set to 1, the MAC replaces the content of the MAC Address 1 registers in the SA field of all transmitted frames.

**ASS2KP** When set, the MAC considers all frames, with up to 2,000 bytes length, as normal packets. When Bit[20] (JE) is not set, the MAC considers all received frames of size more than 2K bytes as Giant frames. When this bit is reset and Bit[20] (JE) is not set, the MAC considers all received frames of size more than 1,518 bytes (1,522 bytes for tagged) as Giant frames. When Bit[20] is set, setting this bit has no effect on Giant Frame status. (R/W)

**EMACWATCHDOG** When this bit is set, the MAC disables the watchdog timer on the receiver. The MAC can receive frames of up to 16,383 bytes. When this bit is reset, the MAC does not allow a receive frame which more than 2,048 bytes (10,240 if JE is set high) or the value programmed in Register (Watchdog Timeout Register). The MAC cuts off any bytes received after the watchdog limit number of bytes. (R/W)

**EMACJABBER** When this bit is set, the MAC disables the jabber timer on the transmitter. The MAC can transfer frames of up to 16,383 bytes. When this bit is reset, the MAC cuts off the transmitter if the application sends out more than 2,048 bytes of data (10,240 if JE is set high) during transmission. (R/W)

**EMACJUMBOFRAME** When this bit is set, the MAC allows Jumbo frames of 9,018 bytes (9,022 bytes for VLAN tagged frames) without reporting a giant frame error in the receive frame status. (R/W)

Continued on the next page...

**Register 10.15. EMACCONFIG\_REG (0x1000)**

Continued from the previous page...

**EMACINTERFRAMEGAP** These bits control the minimum IFG between frames during transmission.  
(R/W)

- 3'b000: 96 bit times.
- 3'b001: 88 bit times.
- 3'b010: 80 bit times.
- 3'b111: 40 bit times. In the half-duplex mode, the minimum IFG can be configured only for 64 bit times (IFG = 100). Lower values are not considered.

**EMACDISABLECRS** When set high, this bit makes the MAC transmitter ignore the MII CRS signal during frame transmission in the half-duplex mode. This request results in no errors generated because of Loss of Carrier or No Carrier during such transmission. When this bit is low, the MAC transmitter generates such errors because of Carrier Sense and can even abort the transmissions.  
(R/W)

**EMACMII** This bit selects the Ethernet line speed. It should be set to 1 for 10 or 100 Mbps operations. In 10 or 100 Mbps operations, this bit, along with FES(EMACFESPEED) bit, it selects the exact linespeed. In the 10/100 Mbps-only operations, the bit is always 1. (R/W)

**EMACFESPEED** This bit selects the speed in the MII, RMII interface. 0: 10 Mbps; 1: 100 Mbps.  
(R/W)

**EMACRXOWN** When this bit is set, the MAC disables the reception of frames when the TX\_EN is asserted in the half-duplex mode. When this bit is reset, the MAC receives all packets that are given by the PHY while transmitting. This bit is not applicable if the MAC is operating in the full-duplex mode. (R/W)

**EMACLOOPBACK** When this bit is set, the MAC operates in the loopback mode MII. The MII Receive clock input (CLK\_RX) is required for the loopback to work properly, because the transmit clock is not looped-back internally. (R/W)

**EMACDUPLEX** When this bit is set, the MAC operates in the full-duplex mode where it can transmit and receive simultaneously. This bit is read only with default value of 1'b1 in the full-duplex-mode.  
(R/W)

**EMACRXIPCOFFLOAD** When this bit is set, the MAC calculates the 16-bit one's complement of the one's complement sum of all received Ethernet frame payloads. It also checks whether the IPv4 Header checksum (assumed to be bytes 25/26 or 29/30 (VLAN-tagged) of the received Ethernet frame) is correct for the received frame and gives the status in the receive status word. The MAC also appends the 16-bit checksum calculated for the IP header datagram payload (bytes after the IPv4 header) and appends it to the Ethernet frame transferred to the application (when Type 2 COE is deselected). When this bit is reset, this function is disabled. (R/W)

Continued on the next page...

**Register 10.15. EMACCONFIG\_REG (0x1000)**

Continued from the previous page...

**EMACRETRY** When this bit is set, the MAC attempts only one transmission. When a collision occurs on the MII interface, the MAC ignores the current frame transmission and reports a Frame Abort with excessive collision error in the transmit frame status. When this bit is reset, the MAC attempts retries based on the settings of the BL field (Bits [6:5]). This bit is applicable only in the half-duplex mode. (R/W)

**EMACPADCRGSTRIP** When this bit is set, the MAC strips the Pad or FCS field on the incoming frames only if the value of the length field is less than 1,536 bytes. All received frames with length field greater than or equal to 1,536 bytes are passed to the application without stripping the Pad or FCS field. When this bit is reset, the MAC passes all incoming frames, without modifying them, to the Host. (R/W)

**EMACBACKOFFLIMIT** The Back-Off limit determines the random integer number ( $r$ ) of slot time delays (512 bit times for 10/100 Mbps) for which the MAC waits before rescheduling a transmission attempt during retries after a collision. This bit is applicable only in the half-duplex mode.

- 00:  $k = \min(n, 10)$ .
- 01:  $k = \min(n, 8)$ .
- 10:  $k = \min(n, 4)$ .
- 11:  $k = \min(n, 1)$ ,  $n =$  retransmission attempt. The random integer  $r$  takes the value in the range  $0 \sim 2000$ .

**EMACDEFERRALCHECK** Deferral Check. (R/W)

**EMACTX** When this bit is set, the transmit state machine of the MAC is enabled for transmission on the MII. When this bit is reset, the MAC transmit state machine is disabled after the completion of the transmission of the current frame, and does not transmit any further frames. (R/W)

**EMACRX** When this bit is set, the receiver state machine of the MAC is enabled for receiving frames from the MII. When this bit is reset, the MAC receive state machine is disabled after the completion of the reception of the current frame, and does not receive any further frames from the MII. (R/W)

**PLTF** These bits control the number of preamble bytes that are added to the beginning of every Transmit frame. The preamble reduction occurs only when the MAC is operating in the full-duplex mode. 2'b00: 7 bytes of preamble. 2'b01: 5 bytes of preamble. 2'b10: 3 bytes of preamble. (R/W)

**Register 10.16. EMACFF\_REG (0x1004)**

RECEIVE_ALL		(reserved)										SAFE	SAIF	PCF	DBF	PAM	DAIF	(reserved)		P.MODE				
31	30											10	9	8	7	6	5	4	3	2	1	0		
0	0	0	0	0	0	0	0	0	0	0	0	0	0	0	0x0	0	0	0	0	0	0	0	0	Reset

**RECEIVE\_ALL** When this bit is set, the MAC Receiver module passes all received frames, irrespective of whether they pass the address filter or not, to the Application. The result of the SA or DA filtering is updated (pass or fail) in the corresponding bits in the Receive Status Word. When this bit is reset, the Receiver module passes only those frames to the Application that pass the SA or DA address filter. (R/W)

**SAFE** When this bit is set, the MAC compares the SA field of the received frames with the values programmed in the enabled SA registers. If the comparison fails, the MAC drops the frame. When this bit is reset, the MAC forwards the received frame to the application with updated SAF bit of the Rx Status depending on the SA address comparison. (R/W)

**SAIF** When this bit is set, the Address Check block operates in inverse filtering mode for the SA address comparison. The frames whose SA matches the SA registers are marked as failing the SA Address filter. When this bit is reset, frames whose SA does not match the SA registers are marked as failing the SA Address filter. (R/W)

**PCF** These bits control the forwarding of all control frames (including unicast and multicast Pause frames). (R/W)

- 2'b00: MAC filters all control frames from reaching the application.
- 2'b01: MAC forwards all control frames except Pause frames to application even if they fail the Address filter.
- 2'b10: MAC forwards all control frames to application even if they fail the Address Filter.
- 2'b11: MAC forwards control frames that pass the Address Filter.

The following conditions should be true for the Pause frames processing:

- Condition 1: The MAC is in the full-duplex mode and flow control is enabled by setting Bit 2 (RFE) of Register (Flow Control Register) to 1.
- Condition 2: The destination address (DA) of the received frame matches the special multicast address or the MAC Address 0 when Bit 3 (UP) of the Register(Flow Control Register) is set.
- Condition 3: The Type field of the received frame is 0x8808 and the OPCODE field is 0x0001.

**DBF** When this bit is set, the AFM(Address Filtering Module) module blocks all incoming broadcast frames. In addition, it overrides all other filter settings. When this bit is reset, the AFM module passes all received broadcast frames. (R/W)

**PAM** When set, this bit indicates that all received frames with a multicast destination address (first bit in the destination address field is '1') are passed. (R/W)

**Continued on the next page...**



**Register 10.16. EMACFF\_REG (0x1004)**

Continued from the previous page...

**DAIF** When this bit is set, the Address Check block operates in inverse filtering mode for the DA address comparison for both unicast and multicast frames. When reset, normal filtering of frames is performed. (R/W)

**PMODE** When this bit is set, the Address Filter module passes all incoming frames irrespective of the destination or source address. The SA or DA Filter Fails status bits of the Receive Status Word are always cleared when PR(PRT\_RATIO) is set. (R/W)

**Register 10.17. EMACMIIADDR\_REG (0x1010)**

(reserved)																MIIDEV				MIIREG				MIICSRCLK		MIIWRITE		MIIBUSY		
31															16	15				11	10			6	5			2	1	0
0																0x00				0x00				0x00		0		0		

Reset

**MIIDEV** This field indicates which of the 32 possible PHY devices are being accessed. (R/W)

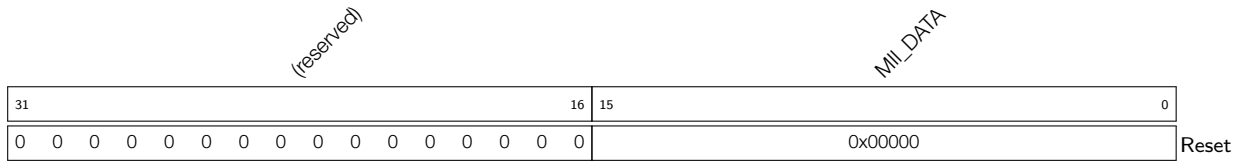
**MIIREG** These bits select the desired MII register in the selected PHY device. (R/W)

[MIICSRCLK]CSR clock range: 1.0 MHz ~ 2.5 MHz. (R/W)

- 4'b0000: When the APB clock frequency is 80 MHz, the MDC clock frequency is APB\_CLK/42;
- 4'b0011: When the APB clock frequency is 40 MHz, the MDC clock frequency is APB\_CLK/26.

**MIIWRITE** When set, this bit indicates to the PHY that this is a Write operation using the MII Data register. If this bit is not set, it indicates that this is a Read operation, that is, placing the data in the MII Data register. (R/W)

**MIIBUSY** This bit should read logic 0 before writing to PHY Addr Register and PHY data Register. During a PHY register access, the software sets this bit to 1'b1 to indicate that a Read or Write access is in progress. PHY data Register is invalid until this bit is cleared by the MAC. Therefore, PHY data Register (MII Data) should be kept valid until the MAC clears this bit during a PHY Write operation. Similarly for a read operation, the contents of Register 5 are not valid until this bit is cleared. The subsequent read or write operation should happen only after the previous operation is complete. Because there is no acknowledgment from the PHY to MAC after a read or write operation is completed, there is no change in the functionality of this bit even when the PHY is not present. (R/WS/SC)

**Register 10.18. EMACMIIDATA\_REG (0x1014)**

**MII\_DATA** This field contains the 16-bit data value read from the PHY after a Management Read operation or the 16-bit data value to be written to the PHY before a Management Write operation. (R/W)

**Register 10.19. EMACFC\_REG (0x1018)**

PAUSE_TIME																(reserved)										PLT		UPFD	RFCE	TFCE	FCBBA
31															16	15							6	5	4	3	2	1	0		
0x00000																0 0 0 0 0 0 0 0 0 0						0x0		0	0	0	0	Reset			

**PAUSE\_TIME** This field holds the value to be used in the Pause Time field in the transmit control frame. If the Pause Time bits is configured to be double-synchronized to the MII clock domain, then consecutive writes to this register should be performed only after at least four clock cycles in the destination clock domain. (R/W)

**PLT** This field configures the threshold of the Pause timer automatic retransmission of the Pause frame. The threshold values should be always less than the Pause Time configured in Bits[31:16]. For example, if PT = 100H (256 slot-times), and PLT = 01, then a second Pause frame is automatically transmitted at 228 (256-28) slot times after the first Pause frame is transmitted. The following list provides the threshold values for different values: (R/W)

- 2'b00: The threshold is Pause time minus 4 slot times (PT-4 slot times).
- 2'b01: The threshold is Pause time minus 28 slot times (PT-28 slot times).
- 2'b10: The threshold is Pause time minus 144 slot times (PT-144 slot times).
- 2'b11: The threshold is Pause time minus 256 slot times (PT-256 slot times). The slot time is defined as the time taken to transmit 512 bits (64 bytes) on the MII interface.

**UPFD** A pause frame is processed when it has the unique multicast address specified in the IEEE Std 802.3. When this bit is set, the MAC can also detect Pause frames with unicast address of the station. This unicast address should be as specified in the EMACADDR0 High Register and EMACADDR0 Low Register. When this bit is reset, the MAC only detects Pause frames with unique multicast address. (R/W)

**RFCE** When this bit is set, the MAC decodes the received Pause frame and disables its transmitter for a specified (Pause) time. When this bit is reset, the decode function of the Pause frame is disabled. (R/W)

**TFCE** In the full-duplex mode, when this bit is set, the MAC enables the flow control operation to transmit Pause frames. When this bit is reset, the flow control operation in the MAC is disabled, and the MAC does not transmit any Pause frames. In the half-duplex mode, when this bit is set, the MAC enables the backpressure operation. When this bit is reset, the backpressure feature is disabled. (R/W)

**Continued on the next page...**

**Register 10.19. EMACFC\_REG (0x1018)**

**Continued from the previous page...**

**FCBBA** This bit initiates a Pause frame in the full-duplex mode and activates the backpressure function in the half-duplex mode if the TFCE bit is set. In the full-duplex mode, this bit should be read as 1'b0 before writing to the Flow Control register. To initiate a Pause frame, the Application must set this bit to 1'b1. During a transfer of the Control Frame, this bit continues to be set to signify that a frame transmission is in progress. After the completion of Pause frame transmission, the MAC resets this bit to 1'b0. The Flow Control register should not be written to until this bit is cleared. In the half-duplex mode, when this bit is set (and TFCE is set), then backpressure is asserted by the MAC. During backpressure, when the MAC receives a new frame, the transmitter starts sending a JAM pattern resulting in a collision. When the MAC is configured for the full-duplex mode, the BPA is automatically disabled. (R/WS/SC)(FCB)/(R/W)(BPA(backpressure activate))

**Register 10.20. EMACDEBUG\_REG (0x1024)**

(reserved)							MTLTSFFS	MTLTFNES	(reserved)			MTLTFWCS	MTLTFRCS	MACTP	MACTFCS	(reserved)				MTLRFFLS	(reserved)			MTLRFRCs	MTLRFWCAS	(reserved)		MACRFFCS	MACRPES
31	26	25	24	23	22	21	20	19	18	17	16	15	10	9	8	7	6	5	4	3	2	1	0						
0	0	0	0	0	0	0x0	0	0x0	0	0	0	0	0	0	0	0x0	0	0x0	0	0	0	0x0	0	0	0x0	0	Reset		

**MTLTSFFS** When high, this bit indicates that the MTL TxStatus FIFO is full. Therefore, the MTL cannot accept any more frames for transmission. (RO)

**MTLTFNES** When high, this bit indicates that the MTL Tx FIFO is not empty and some data is left for transmission. (RO)

**MTLTFWCS** When high, this bit indicates that the MTL Tx FIFO Write Controller is active and is transferring data to the Tx FIFO. (RO)

**MTLTFRCS** This field indicates the state of the Tx FIFO Read Controller: (RO)

- 2'b00: IDLE state.
- 2'b01: READ state (transferring data to the MAC transmitter).
- 2'b10: Waiting for TxStatus from the MAC transmitter.
- 2'b11: Writing the received TxStatus or flushing the Tx FIFO.

**MACTP** When high, this bit indicates that the MAC transmitter is in the Pause condition (in the full-duplex-mode) and hence does not schedule any frame for transmission. (RO)

**MACTFCS** This field indicates the state of the MAC Transmit Frame Controller module: (RO)

- 2'b00: IDLE state.
- 2'b01: Waiting for status of previous frame or IFG or backoff period to be over.
- 2'b10: Generating and transmitting a Pause frame (in the full-duplex mode).
- 2'b11: Transferring input frame for transmission.

**MACTPES** When high, this bit indicates that the MAC MII transmit protocol engine is actively transmitting data and is not in the IDLE state. (RO)

**MTLRFFLS** This field gives the status of the fill-level of the Rx FIFO: (RO)

- 2'b00: Rx FIFO Empty.
- 2'b01: Rx FIFO fill-level below flow-control deactivate threshold.
- 2'b10: Rx FIFO fill-level above flow-control activate threshold.
- 2'b11: Rx FIFO Full.

**Continued on the next page...**

**Register 10.20. EMACDEBUG\_REG (0x1024)**

**Continued from the previous page...**

**MTLRFRC** This field gives the state of the Rx FIFO read Controller: (RO)

2'b00: IDLE state.

2'b01: Reading frame data.

2'b10: Reading frame status (or timestamp).

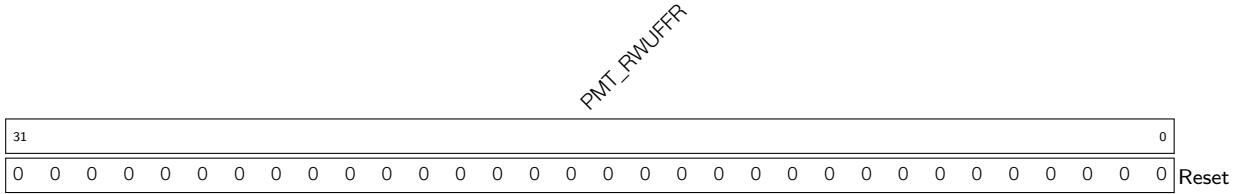
2'b11: Flushing the frame data and status.

**MTLRFWCAS** When high, this bit indicates that the MTL Rx FIFO Write Controller is active and is transferring a received frame to the FIFO. (RO)

**MACRFFCS** When high, this field indicates the active state of the FIFO Read and Write controllers of the MAC Receive Frame Controller Module. MACRFFCS[1] represents the status of FIFO Read controller. MACRFFCS[0] represents the status of small FIFO Write controller. (RO)

**MACRPES** When high, this bit indicates that the MAC MII receive protocol engine is actively receiving data and not in IDLE state. (RO)

**Register 10.21. PMT\_RWUFFR\_REG (0x1028)**



**WKUPPKTFILTER** The MSB (31st bit) must be zero. Bit j[30:0] is the byte mask. If Bit 1/2/3/4 (byte number) of the byte mask is set, the CRC block processes the filter 0/1/2/3 Offset + j of the incoming packet (RWKPTR is 0/1/2/3). (R/W)

- RWKPTR is 0: Filter 0 Byte Mask;
- RWKPTR is 1: Filter 1 Byte Mask;
- RWKPTR is 2: Filter 2 Byte Mask;
- RWKPTR is 3: Filter 3 Byte Mask;
- RWKPTR is 4: Bit 3/11/19/27 specifies the address type, defining the destination address type of the pattern. When the bit is set, the pattern applies to only multicast packets; when the bit is reset, the pattern applies only to unicast packet for filter 0/1/2/3. Bit 0/8/16/24 is the enable bit for filter 0/1/2/3;
- RWKPTR is 5: This filter 0/1/2/3 offset register defines the offset (within the packet) from which the filter 0/1/2/3 examines the packets;
- RWKPTR is 6: This filter 0 (bit[15:0])/1 (bit[31:16]) CRC16 register contains the CRC16 value calculated from the pattern and also the byte mask programmed to the wake-up filter register block; The polynomial:  
$$G(x) = x^{16} + x^{15} + x^2 + 1.$$
- RWKPTR is 7: This filter 2 (bit[15:0])/3 (bit[31:16]) CRC16 register contains the CRC16 value calculated from the pattern and also the byte mask programmed to the wake-up filter register block. The polynomial:  
$$G(x) = x^{16} + x^{15} + x^2 + 1.$$





**Register 10.23. EMACLPI\_CSR\_REG (0x1030)**

(reserved)										LPITXA (reserved) PLS LPIEN				(reserved)				RLPIST TLPIST		(reserved)				RLPIEX RLPIEN TLPIEX TLPIEN									
31										20	19	18	17	16	15					10	9	8	7					4	3	2	1	0	
0	0	0	0	0	0	0	0	0	0	0	0	0	0	0	0	0	0	0	0	0	0	0	0	0	0	0	0	0	0	0	0	0	Reset

**LPITXA** This bit controls the behavior of the MAC when it is entering or coming out of the LPI mode on the transmit side. If the LPITXA and LPIEN bits are set to 1, the MAC enters the LPI mode only after all outstanding frames and pending frames have been transmitted. The MAC comes out of the LPI mode when the application sends any frame. When this bit is 0, the LPIEN bit directly controls behavior of the MAC when it is entering or coming out of the LPI mode. (R/W)

**PLS** This bit indicates the link status of the PHY. When set, the link is considered to be okay (up) and when reset, the link is considered to be down. (R/W)

**LPIEN** When set, this bit instructs the MAC Transmitter to enter the LPI state. When reset, this bit instructs the MAC to exit the LPI state and resume normal transmission. This bit is cleared when the LPITXA bit is set and the MAC exits the LPI state because of the arrival of a new packet for transmission. (R/W/SC)

**RLPIST** When set, this bit indicates that the MAC is receiving the LPI pattern on the MII interface. (R/W)

**TLPIST** When set, this bit indicates that the MAC is receiving the LPI pattern on the MII interface. (R/W)

**RLPIEX** When set, this bit indicates that the MAC Receiver has stopped receiving the LPI pattern on the MII interface, exited the LPI state, and resumed the normal reception. This bit is cleared by a read into this register. (R/SS/RC)

**RLPIEN** When set, this bit indicates that the MAC Receiver has received an LPI pattern and entered the LPI state. This bit is cleared by a read into this register. (R/SS/RC)

**TLPIEX** When set, this bit indicates that the MAC transmitter has exited the LPI state after the user has cleared the LPIEN bit and the LPI\_TW\_Timer has expired. This bit is cleared by a read into this register. (R/SS/RC)

**TLPIEN** When set, this bit indicates that the MAC Transmitter has entered the LPI state because of the setting of the LPIEN bit. This bit is cleared by a read into this register. (R/SS/RC)

**Register 10.24. EMACLPITIMERSCONTROL\_REG (0x1034)**

(reserved)							LPI_LS_TIMER								LPI_TW_TIMER																					
31	26	25						16	15																	0										
0	0	0	0	0	0	0	0	x	3	E	8	0	0	0	0	0	0	0	0	0	0	0	0	0	0	0	0	0	0	0	0	0	0	0	0	Reset

**LPI\_LS\_TIMER** This field specifies the minimum time (in milliseconds) for which the link status from the PHY should be up (OKAY) before the LPI pattern can be transmitted to the PHY. The MAC does not transmit the LPI pattern even when the LPIEN bit is set unless the LPI\_LS\_Timer reaches the programmed terminal count. The default value of the LPI\_LS\_Timer is 1000 (1 sec) as defined in the IEEE standard.(R/W)

**LPI\_TW\_TIMER** This field specifies the minimum time (in microseconds) for which the MAC waits after it stops transmitting the LPI pattern to the PHY and before it resumes the normal transmission. The TLPIEX status bit is set after the expiry of this timer.(R/W)

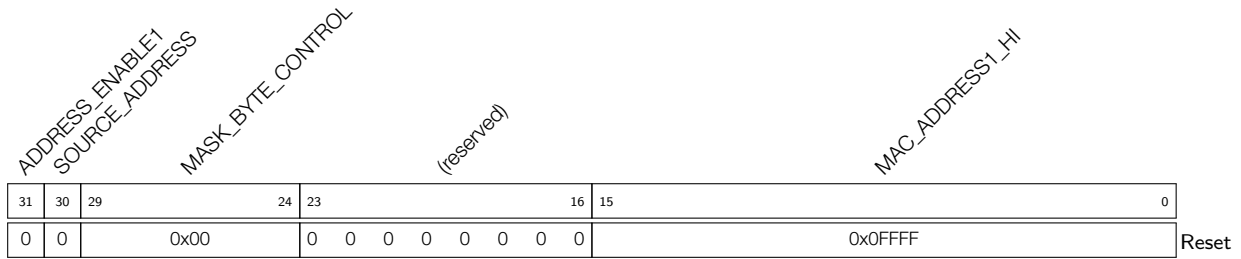
**Register 10.25. EMACINTS\_REG (0x1038)**

(reserved)																LPIINTS (reserved)			(reserved)				PMTINTS (reserved)										
31												11	10	9	8					4	3	2	0										
0	0	0	0	0	0	0	0	0	0	0	0	0	0	0	0	0	0	0	0	0	0	0	0	0	0	0	0	0	0	0	0	0	Reset

**LPIINTS** When the Energy Efficient Ethernet feature is enabled, this bit is set for any LPI state entry or exit in the MAC Transmitter or Receiver. This bit is cleared on reading Bit[0] of Register (LPI Control and Status Register). (RO)

**PMTINTS** This bit is set when a magic packet or remote wake-up frame is received in the power-down mode (see Bit[5] and Bit[6] in the PMT Control and Status Register). This bit is cleared when both Bits[6:5] are cleared because of a read operation to the PMT Control and Status register. This bit is valid only when you select the optional PMT module during core configuration. (RO)



**Register 10.29. EMACADDR1HIGH\_REG (0x1048)**

**ADDRESS\_ENABLE1** When this bit is set, the address filter module uses the second MAC address for perfect filtering. When this bit is reset, the address filter module ignores the address for filtering. (R/W)

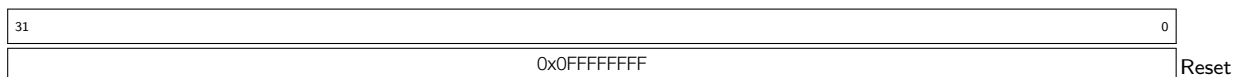
**SOURCE\_ADDRESS** When this bit is set, the EMACADDR1[47:0] is used to compare with the SA fields of the received frame. When this bit is reset, the EMACADDR1[47:0] is used to compare with the DA fields of the received frame. (R/W)

**MASK\_BYTE\_CONTROL** These bits are mask control bits for comparison of each of the EMACADDR1 bytes. When set high, the MAC does not compare the corresponding byte of received DA or SA with the contents of EMACADDR1 registers. Each bit controls the masking of the bytes as follows:

- Bit[29]: EMACADDR1 High [15:8].
- Bit[28]: EMACADDR1 High [7:0].
- Bit[27]: EMACADDR1 Low [31:24].
- Bit[24]: EMACADDR1 Low [7:0].

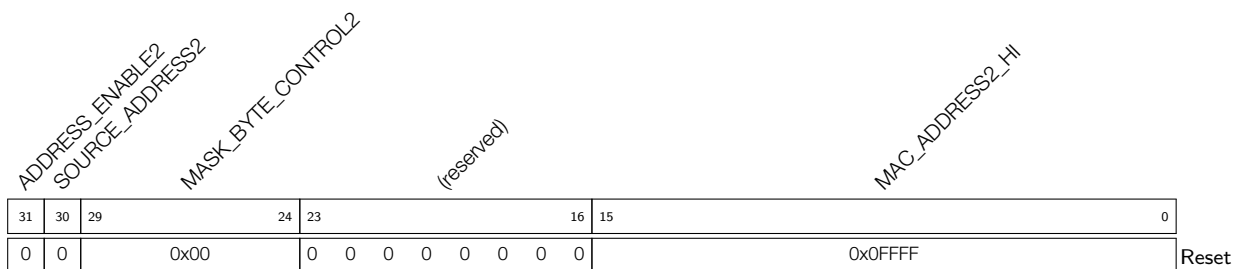
You can filter a group of addresses (known as group address filtering) by masking one or more bytes of the address. (R/W)

**MAC\_ADDRESS1\_HI** This field contains the upper 16 bits, Bits[47:32] of the second 6-byte MAC address. (R/W)

**Register 10.30. EMACADDR1LOW\_REG (0x104C)**

**EMACADDR1LOW\_REG** This field contains the lower 32 bits of the second 6-byte MAC address. The content of this field is undefined, so the register needs to be configured after the initialization process. (R/W)

**Register 10.31. EMACADDR2HIGH\_REG (0x1050)**



**ADDRESS\_ENABLE2** When this bit is set, the address filter module uses the third MAC address for perfect filtering. When this bit is reset, the address filter module ignores the address for filtering. (R/W)

**SOURCE\_ADDRESS2** When this bit is set, the EMACADDR2[47:0] is used to compare with the SA fields of the received frame. When this bit is reset, the EMACADDR2[47:0] is used to compare with the DA fields of the received frame. (R/W)

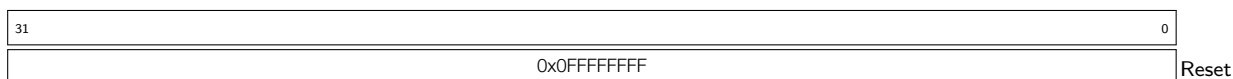
**MASK\_BYTE\_CONTROL2** These bits are mask control bits for comparison of each of the EMACADDR2 bytes. When set high, the MAC does not compare the corresponding byte of received DA or SA with the contents of EMACADDR2 registers. Each bit controls the masking of the bytes as follows:

- Bit[29]: EMACADDR2 High [15:8].
- Bit[28]: EMACADDR2 High [7:0].
- Bit[27]: EMACADDR2 Low [31:24].
- Bit[24]: EMACADDR2 Low [7:0].

You can filter a group of addresses (known as group address filtering) by masking one or more bytes of the address. (R/W)

**MAC\_ADDRESS2\_HI** This field contains the upper 16 bits, Bits[47:32] of the third 6-byte MAC address. (R/W)

**Register 10.32. EMACADDR2LOW\_REG (0x1054)**



**EMACADDR2LOW\_REG** This field contains the lower 32 bits of the third 6-byte MAC address. The content of this field is undefined, so the register needs to be configured after the initialization process. (R/W)

**Register 10.33. EMACADDR3HIGH\_REG (0x1058)**

ADDRESS_ENABLE3 SOURCE_ADDRESS3		MASK_BYTE_CONTROL3				(reserved)				MAC_ADDRESS3_HI				
31	30	29	24	23	16	15							0	
0	0	0x00		0	0	0	0	0	0	0	0	0x0FFFF		Reset

**ADDRESS\_ENABLE3** When this bit is set, the address filter module uses the fourth MAC address for perfect filtering. When this bit is reset, the address filter module ignores the address for filtering. (R/W)

**SOURCE\_ADDRESS3** When this bit is set, the EMACADDR3[47:0] is used to compare with the SA fields of the received frame. When this bit is reset, the EMACADDR3[47:0] is used to compare with the DA fields of the received frame. (R/W)

**MASK\_BYTE\_CONTROL3** These bits are mask control bits for comparison of each of the EMACADDR3 bytes. When set high, the MAC does not compare the corresponding byte of received DA or SA with the contents of EMACADDR3 registers. Each bit controls the masking of the bytes as follows:

- Bit[29]: EMACADDR3 High [15:8].
- Bit[28]: EMACADDR3 High [7:0].
- Bit[27]: EMACADDR3 Low [31:24].
- Bit[24]: EMACADDR3 Low [7:0].

You can filter a group of addresses (known as group address filtering) by masking one or more bytes of the address. (R/W)

**MAC\_ADDRESS3\_HI** This field contains the upper 16 bits, Bits[47:32] of the fourth 6-byte MAC address. (R/W)

**Register 10.34. EMACADDR3LOW\_REG (0x105C)**

31												0	
0x0FFFFFFF													Reset

**EMACADDR3LOW\_REG** This field contains the lower 32 bits of the fourth 6-byte MAC address. The content of this field is undefined, so the register needs to be configured after the initialization process. (R/W)

**Register 10.35. EMACADDR4HIGH\_REG (0x1060)**

ADDRESS_ENABLE4 SOURCE_ADDRESS4		MASK_BYTE_CONTROL4				(reserved)				MAC_ADDRESS4_HI							
31	30	29	24	23	16	15							0				
0	0	0x00				0	0	0	0	0	0	0	0	0	0	0x0FFFF	Reset

**ADDRESS\_ENABLE4** When this bit is set, the address filter module uses the fifth MAC address for perfect filtering. When this bit is reset, the address filter module ignores the address for filtering. (R/W)

**SOURCE\_ADDRESS4** When this bit is set, the EMACADDR4[47:0] is used to compare with the SA fields of the received frame. When this bit is reset, the EMACADDR4[47:0] is used to compare with the DA fields of the received frame. (R/W)

**MASK\_BYTE\_CONTROL4** These bits are mask control bits for comparison of each of the EMACADDR4 bytes. When set high, the MAC does not compare the corresponding byte of received DA or SA with the contents of EMACADDR4 registers. Each bit controls the masking of the bytes as follows:

- Bit[29]: EMACADDR4 High [15:8].
- Bit[28]: EMACADDR4 High [7:0].
- Bit[27]: EMACADDR4 Low [31:24].
- Bit[24]: EMACADDR4 Low [7:0].

You can filter a group of addresses (known as group address filtering) by masking one or more bytes of the address. (R/W)

**MAC\_ADDRESS4\_HI** This field contains the upper 16 bits, Bits[47:32] of the fifth 6-byte MAC address. (R/W)

**Register 10.36. EMACADDR4LOW\_REG (0x1064)**

31															0	
0x0FFFFFFF																Reset

**EMACADDR4LOW\_REG** This field contains the lower 32 bits of the fifth 6-byte MAC address. The content of this field is undefined, so the register needs to be configured after the initialization process. (R/W)

**Register 10.37. EMACADDR5HIGH\_REG (0x1068)**

ADDRESS_ENABLE5		SOURCE_ADDRESS5		MASK_BYTE_CONTROL5					(reserved)		MAC_ADDRESS5_HI			
31	30	29	24	23	16	15					0			
0	0	0x00		0	0	0	0	0	0	0	0x0FFFF		Reset	

**ADDRESS\_ENABLE5** When this bit is set, the address filter module uses the sixth MAC address for perfect filtering. When this bit is reset, the address filter module ignores the address for filtering. (R/W)

**SOURCE\_ADDRESS5** When this bit is set, the EMACADDR5[47:0] is used to compare with the SA fields of the received frame. When this bit is reset, the EMACADDR5[47:0] is used to compare with the DA fields of the received frame. (R/W)

**MASK\_BYTE\_CONTROL5** These bits are mask control bits for comparison of each of the EMACADDR5 bytes. When set high, the MAC does not compare the corresponding byte of received DA or SA with the contents of EMACADDR5 registers. Each bit controls the masking of the bytes as follows:

- Bit[29]: EMACADDR5 High [15:8].
- Bit[28]: EMACADDR5 High [7:0].
- Bit[27]: EMACADDR5 Low [31:24].
- Bit[24]: EMACADDR5 Low [7:0].

You can filter a group of addresses (known as group address filtering) by masking one or more bytes of the address. (R/W)

**MAC\_ADDRESS5\_HI** This field contains the upper 16 bits, Bits[47:32] of the sixth 6-byte MAC address. (R/W)

**Register 10.38. EMACADDR5LOW\_REG (0x106C)**

31	0
0x0FFFFFFF	
Reset	

**EMACADDR5LOW\_REG** This field contains the lower 32 bits of the sixth 6-byte MAC address. The content of this field is undefined, so the register needs to be configured after the initialization process. (R/W)



**Register 10.39. EMACADDR6HIGH\_REG (0x1070)**



**ADDRESS\_ENABLE6** When this bit is set, the address filter module uses the seventh MAC address for perfect filtering. When this bit is reset, the address filter module ignores the address for filtering. (R/W)

**SOURCE\_ADDRESS6** When this bit is set, the EMACADDR6[47:0] is used to compare with the SA fields of the received frame. When this bit is reset, the EMACADDR6[47:0] is used to compare with the DA fields of the received frame. (R/W)

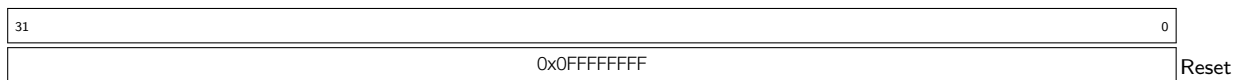
**MASK\_BYTE\_CONTROL6** These bits are mask control bits for comparison of each of the EMACADDR6 bytes. When set high, the MAC does not compare the corresponding byte of received DA or SA with the contents of EMACADDR6 registers. Each bit controls the masking of the bytes as follows:

- Bit[29]: EMACADDR6 High [15:8].
- Bit[28]: EMACADDR6 High [7:0].
- Bit[27]: EMACADDR6 Low [31:24].
- Bit[24]: EMACADDR6 Low [7:0].

You can filter a group of addresses (known as group address filtering) by masking one or more bytes of the address. (R/W)

**MAC\_ADDRESS6\_HI** This field contains the upper 16 bits, Bits[47:32] of the seventh 6-byte MAC address. (R/W)

**Register 10.40. EMACADDR6LOW\_REG (0x1074)**



**EMACADDR6LOW\_REG** This field contains the lower 32 bits of the seventh 6-byte MAC address. The content of this field is undefined, so the register needs to be configured after the initialization process. (R/W)

**Register 10.41. EMACADDR7HIGH\_REG (0x1078)**

ADDRESS_ENABLE7 SOURCE_ADDRESS7		MASK_BYTE_CONTROL7				(reserved)								MAC_ADDRESS7_HI								
31	30	29	24	23	16	15																0
0	0	0x00				0	0	0	0	0	0	0	0	0x0FFFF								Reset

**ADDRESS\_ENABLE7** When this bit is set, the address filter module uses the eighth MAC address for perfect filtering. When this bit is reset, the address filter module ignores the address for filtering. (R/W)

**SOURCE\_ADDRESS7** When this bit is set, the EMACADDR7[47:0] is used to compare with the SA fields of the received frame. When this bit is reset, the EMACADDR7[47:0] is used to compare with the DA fields of the received frame. (R/W)

**MASK\_BYTE\_CONTROL7** These bits are mask control bits for comparison of each of the EMACADDR7 bytes. When set high, the MAC does not compare the corresponding byte of received DA or SA with the contents of EMACADDR7 registers. Each bit controls the masking of the bytes as follows:

- Bit[29]: EMACADDR7 High [15:8].
- Bit[28]: EMACADDR7 High [7:0].
- Bit[27]: EMACADDR7 Low [31:24].
- Bit[24]: EMACADDR7 Low [7:0].

You can filter a group of addresses (known as group address filtering) by masking one or more bytes of the address. (R/W)

**MAC\_ADDRESS7\_HI** This field contains the upper 16 bits, Bits[47:32] of the eighth 6-byte MAC address. (R/W)

**Register 10.42. EMACADDR7LOW\_REG (0x107C)**

31																															0	
0x0FFFFFFF																																Reset

**EMACADDR7LOW\_REG** This field contains the lower 32 bits of the eighth 6-byte MAC address. The content of this field is undefined, so the register needs to be configured after the initialization process. (R/W)

**Register 10.43. EMACSTATUS\_REG (0x10D8)**

(reserved)										SMDRXS					(reserved)										(JABBER_TIMEOUT)	(reserved)	LINK_SPEED	LINK_MODE									
31																17	16	15											5	4	3	2	1	0			
0																	0					0										0	0	0	0	0	Reset

**JABBER\_TIMEOUT** This bit indicates whether there is jabber timeout error (1'b1) in the received frame. (RO)

**LINK\_SPEED** This bit indicates the current speed of the link: (RO)

- 2'b00: 2.5 MHz.
- 2'b01: 25 MHz.
- 2'b10: 125 MHz.

**LINK\_MODE** This bit indicates the current mode of operation of the link: (RO)

- 1'b0: Half-duplex mode.
- 1'b1: Full-duplex mode.

**Register 10.44. EMACWDOGTO\_REG (0x10DC)**

(reserved)															PWDGEN				(reserved)										WDOGTO													
31																17	16	15	14	13																						
0																	0					0x0000																				Reset

**PWDGEN** When this bit is set and Bit[23] (WD) of EMACCONFIG\_REG is reset, the WTO field (Bits[13:0]) is used as watchdog timeout for a received frame. When this bit is cleared, the watchdog timeout for a received frame is controlled by the setting of Bit[23] (WD) and Bit[20] (JE) in EMACCONFIG\_REG. (R/W)

**WDOGTO** When Bit[16] (PWE) is set and Bit[23] (WD) of EMACCONFIG\_REG is reset, this field is used as watchdog timeout for a received frame. If the length of a received frame exceeds the value of this field, such frame is terminated and declared as an error frame. (R/W)

**Register 10.45. EMAC\_EX\_CLKOUT\_CONF\_REG (0x0000)**

(reserved)																EMAC_CLK_OUT_H_DIV_NUM			EMAC_CLK_OUT_DIV_NUM				
31																	8	7		4	3	0	
0	0	0	0	0	0	0	0	0	0	0	0	0	0	0	0	0	0	0	0	0	0	0	0
																		0x02		0x04		Reset	

**EMAC\_CLK\_OUT\_H\_DIV\_NUM** RMII CLK using internal APLL CLK, the half divider number, when using RMII PHY. (R/W)

**EMAC\_CLK\_OUT\_DIV\_NUM** RMII CLK using internal APLL CLK, the whole divider number, when using RMII PHY. (R/W)

**Register 10.46. EMAC\_EX\_OSCCLK\_CONF\_REG (0x0004)**

(reserved)								EMAC_OSC_CLK_SEL					EMAC_OSC_H_DIV_NUM_100M					EMAC_OSC_DIV_NUM_100M					EMAC_OSC_H_DIV_NUM_10M					EMAC_OSC_DIV_NUM_10M				
31								25	24	23					18	17					12	11					6	5	0			
0	0	0	0	0	0	0	0	0	0	0				0					1										19			
																												Reset				

**EMAC\_OSC\_CLK\_SEL** Ethernet work using external PHY output clock or not for RMII CLK, when using RMII PHY. When this bit is set to 1, external PHY CLK is used. When this bit is set to 0, APLL CLK is used. (R/W)

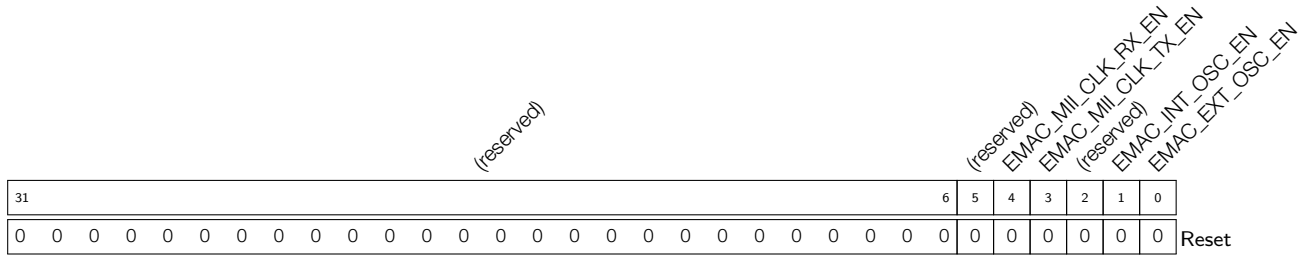
**EMAC\_OSC\_H\_DIV\_NUM\_100M** RMII/MII half-integer divider, when register EMAC\_EX\_CLKOUT\_CONF clock divider's speed is 100M. (R/W)

**EMAC\_OSC\_DIV\_NUM\_100M** RMII/MII whole-integer divider, when register EMAC\_EX\_CLKOUT\_CONF clock divider's speed is 100M. (R/W)

**EMAC\_OSC\_H\_DIV\_NUM\_10M** RMII/MII half-integer divider, when register EMAC\_EX\_CLKOUT\_CONF clock divider's speed is 10M. (R/W)

**EMAC\_OSC\_DIV\_NUM\_10M** RMII/MII whole-integer divider, when register EMAC\_EX\_CLKOUT\_CONF clock divider's speed is 10M. (R/W)

**Register 10.47. EMAC\_EX\_CLK\_CTRL\_REG (0x0008)**



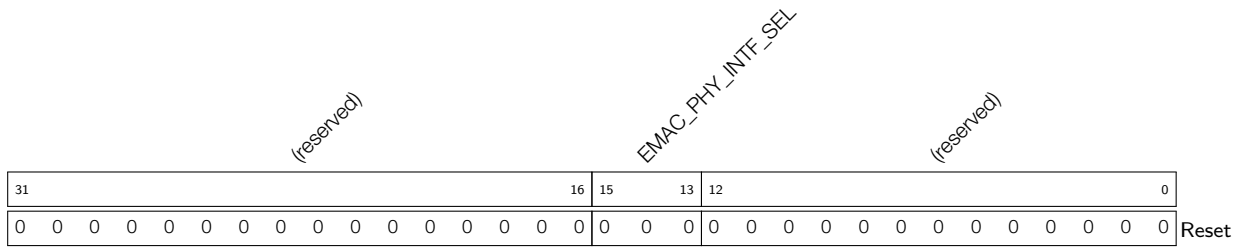
**EMAC\_MII\_CLK\_RX\_EN** Enable Ethernet RX CLK. (R/W)

**EMAC\_MII\_CLK\_TX\_EN** Enable Ethernet TX CLK. (R/W)

**EMAC\_INT\_OSC\_EN** Using internal APLL CLK in RMII PHY mode. (R/W)

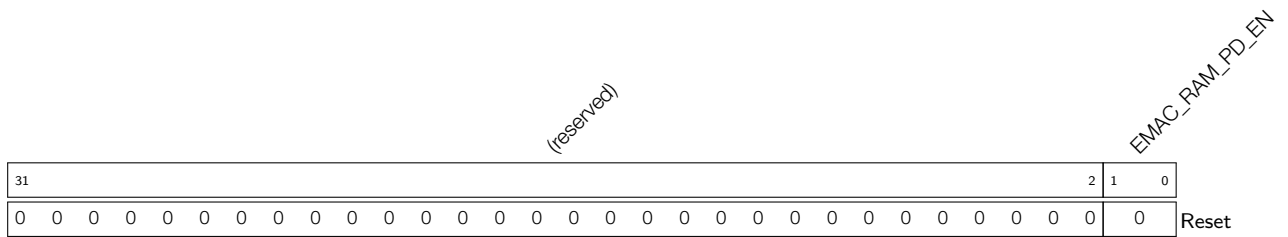
**EMAC\_EXT\_OSC\_EN** Using external APLL CLK in RMII PHY mode. (R/W)

**Register 10.48. EMAC\_EX\_PHYINF\_CONF\_REG (0x000C)**



**EMAC\_PHY\_INTF\_SEL** The PHY interface selected. 0x0: PHY MII, 0x4: PHY RMII. (R/W)

**Register 10.49. EMAC\_PD\_SEL\_REG (0x0010)**



**EMAC\_RAM\_PD\_EN** Ethernet RAM power-down enable signal. Bit[0]: TX SRAM; Bit[1]: RX SRAM. Setting the bit to 1 powers down the RAM. (R/W)

## 11 I2C Controller (I2C)

### 11.1 Overview

An I2C (Inter-Integrated Circuit) bus can be used for communication with several external devices connected to the same bus as ESP32. The ESP32 has dedicated hardware to communicate with peripherals on the I2C bus.

### 11.2 Features

The I2C controller has the following features:

- Supports both master mode and slave mode
- Supports multi-master and multi-slave communication
- Supports standard mode (100 kbit/s)
- Supports fast mode (400 kbit/s)
- Supports 7-bit addressing and 10-bit addressing
- Supports continuous data transmission with disabled Serial Clock Line (SCL)
- Supports programmable digital noise filter

### 11.3 Functional Description

#### 11.3.1 Introduction

I2C is a two-wire bus, consisting of an SDA and an SCL line. These lines are configured to open the drain output. The lines are shared by two or more devices: usually one or more masters and one or more slaves.

Communication starts when a master sends out a start condition: it will pull the SDA line low, and will then pull the SCL line high. It will send out nine clock pulses over the SCL line. The first eight pulses are used to shift out a byte consisting of a 7-bit address and a read/write bit. If a slave with this address is active on the bus, the slave can answer by pulling the SDA low on the ninth clock pulse. The master can then send out more 9-bit clock pulse clusters and, depending on the read/write bit sent, the device or the master will shift out data on the SDA line, with the other side acknowledging the transfer by pulling the SDA low on the ninth clock pulse. During data transfer, the SDA line changes only when the SCL line is low. When the master has finished the communication, it will send a stop condition on the bus by raising SDA, while SCL will already be high.

The ESP32 I2C peripheral can handle the I2C protocol, freeing up the processor cores for other tasks.

### 11.3.2 Architecture

An I2C controller can operate either in master mode or slave mode. The I2C\_MS\_MODE register is used to select the mode. Figure 11-1 shows the I2C Master architecture, while Figure 11-2 shows the I2C Slave architecture.

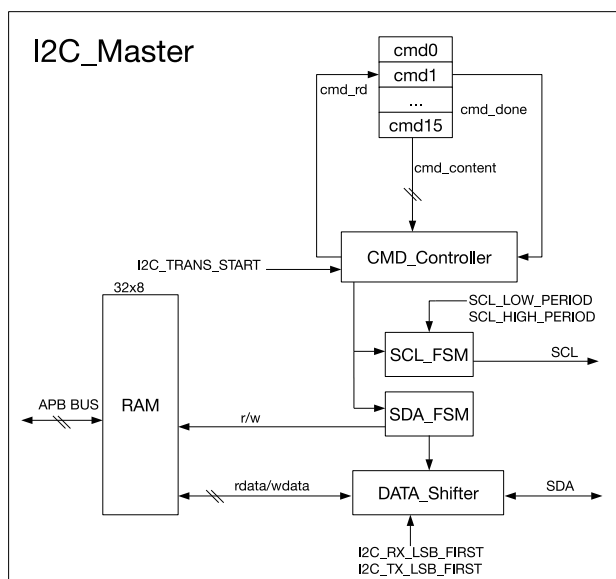


Figure 11-1. I2C Master Architecture

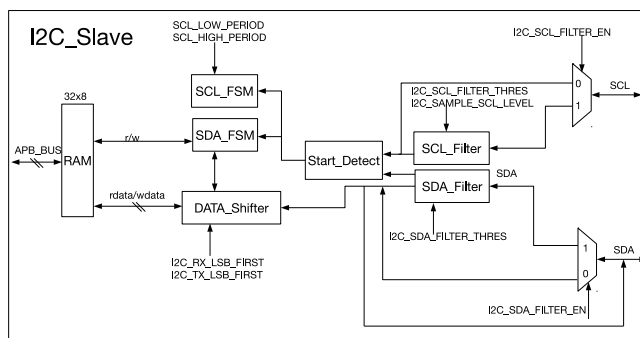


Figure 11-2. I2C Slave Architecture

The I2C controller contains the following units:

- RAM, the size of which is 32 x 8 bits, and it is directly mapped onto the address space of the CPU cores, starting at address REG\_I2C\_BASE+0x100. Each byte of I2C data is stored in a 32-bit word of memory (so, the first byte is at +0x100, the second byte at +0x104, the third byte at +0x108, etc.) Users need to set register I2C\_NONFIFO\_EN.
- A CMD\_Controller and 16 command registers (cmd0 ~ cmd15), which are used by the I2C Master to control data transmission. One command at a time is executed by the I2C controller.
- SCL\_FSM: A state machine that controls the SCL clock. The I2C\_SCL\_HIGH\_PERIOD\_REG and I2C\_SCL\_LOW\_PERIOD\_REG registers are used to configure the frequency and duty cycle of the signal on the SCL line.
- SDA\_FSM: A state machine that controls the SDA data line.

- DATA\_Shifter which converts the byte data to an outgoing bitstream, or converts an incoming bitstream to byte data. I2C\_RX\_LSB\_FIRST and I2C\_TX\_LSB\_FIRST can be used for configuring whether the LSB or MSB is stored or transmitted first.
- SCL\_Filter and SDA\_Filter: Input noise filter for the I2C\_Slave. The filter can be enabled or disabled by configuring I2C\_SCL\_FILTER\_EN and I2C\_SDA\_FILTER\_EN. The filter can remove line glitches with pulse width less than I2C\_SCL\_FILTER\_THRES and I2C\_SDA\_FILTER\_THRES ABP clock cycles.

### 11.3.3 I2C Bus Timing

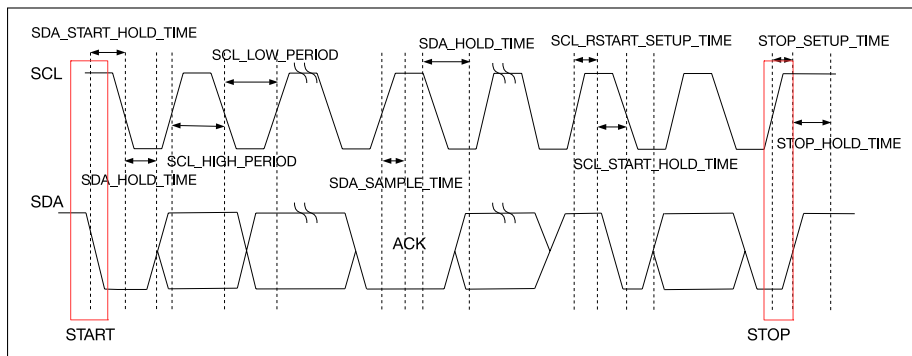


Figure 11-3. I2C Sequence Chart

Figure 11-3 is an I2C sequence chart. When the I2C controller works in master mode, SCL is an output signal. In contrast, when the I2C controller works in slave mode, the SCL becomes an input signal. The values assigned to I2C\_SDA\_HOLD\_REG and I2C\_SDA\_SAMPLE\_REG are still valid in slave mode. Users need to configure the values of I2C\_SDA\_HOLD\_TIME and I2C\_SDA\_SAMPLE\_TIME, according to the host characteristics, for the I2C slave to receive data properly. Table 11-1 shows available settings of SCL low and high level cycles when SCL is configured to direct output mode. The settings determine the SCL output frequency  $f_{scl}$ .

Table 11-1. SCL Frequency Configuration

I2C_SCL_FILTER_EN	I2C_SCL_FILTER_THRES	SCL_Low_Level_Cycles	SCL_High_Level_Cycles
0	Don't care	I2C_SCL_LOW_PERIOD+1	I2C_SCL_HIGH_PERIOD+7
1	[0,2]		I2C_SCL_HIGH_PERIOD+8
	[3,7]		I2C_SCL_HIGH_PERIOD+6+I2C_SCL_FILTER_THRES

$$f_{scl} = \frac{80 \text{ MHz}}{\text{SCL\_Low\_Level\_Cycles} + \text{SCL\_High\_Level\_Cycles}}$$

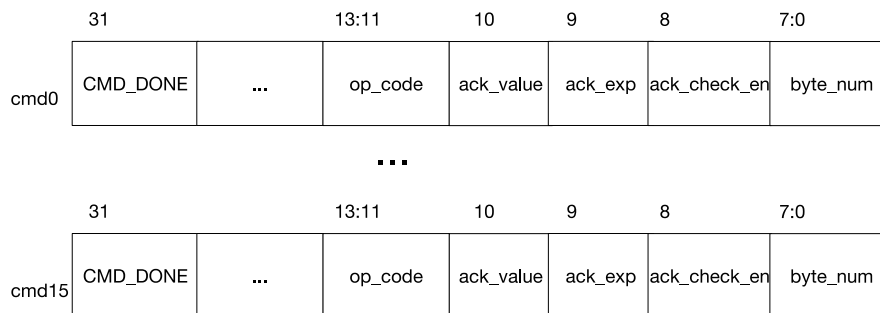
According to the I2C protocol, each transmission of data begins with a START condition and ends with a STOP condition. Data is transmitted by one byte at a time, and each byte has an ACK bit. The receiver informs the transmitter to continue transmission by pulling down SDA, which indicates an ACK. The receiver can also indicate it wants to stop further transmission by pulling up the SDA line, thereby not indicating an ACK.

Figure 11-3 also shows the registers that can configure the START bit, STOP bit, SDA hold time, and SDA sample time.

**Notice:** If the I2C pads are configured in open-drain mode, it will take longer for the signal lines to transition from a low level to a high level. The transition duration is determined together by the pull-up resistor and capacitor. The output frequency of SCL is relatively low in open-drain mode.



### 11.3.4 I2C cmd Structure



**Figure 11-4. Structure of The I2C Command Register**

The Command register is active only in I2C master mode, with its internal structure shown in Figure 11-4.

**CMD\_DONE:** The CMD\_DONE bit of every command can be read by software to tell if the command has been handled by hardware.

**op\_code:** op\_code is used to indicate the command. The I2C controller supports four commands:

- **RSTART:** op\_code = 0 is the RSTART command to control the transmission of a START or RESTART I2C condition.
- **WRITE:** op\_code = 1 is the WRITE command for the I2C Master to transmit data.
- **READ:** op\_code = 2 is the READ command for the I2C Master to receive data.
- **STOP:** op\_code = 3 is the STOP command to control the transmission of a STOP I2C condition.
- **END:** op\_code = 4 is the END command for continuous data transmission. When the END command is given, SCL is temporarily disabled to allow software to reload the command and data registers for subsequent events before resuming. Transmission will then continue seamlessly.

A complete data transmission process begins with an RSTART command, and ends with a STOP command.

**ack\_value:** When receiving data, this bit is used to indicate whether the receiver will send an ACK after this byte has been received.

**ack\_exp:** This bit is to set an expected ACK value for the transmitter.

**ack\_check\_en:** When transmitting a byte, this bit enables checking the ACK value received against the ack\_exp value. Checking is enabled by 1, while 0 disables it.

**byte\_num:** This register specifies the length of data (in bytes) to be read or written. The maximum length is 255, while the minimum is 1. When the op\_code is RSTART, STOP or END, this value is meaningless.

### 11.3.5 I2C Master Writes to Slave

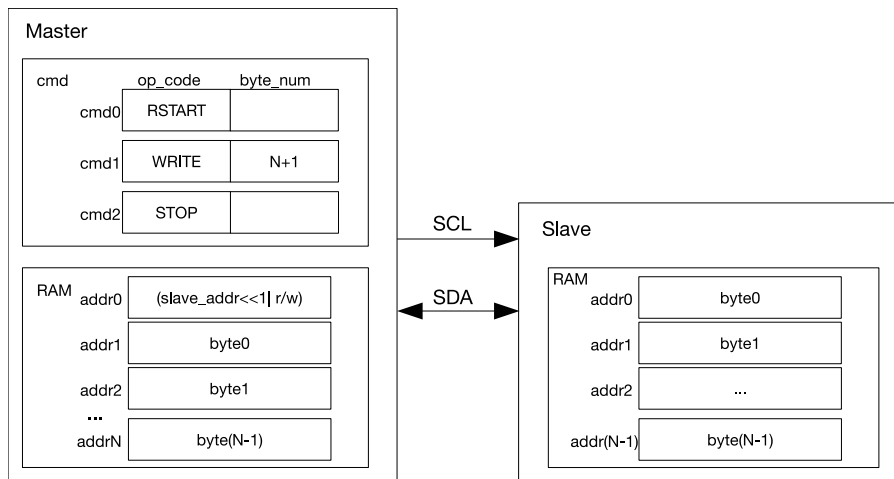


Figure 11-5. I2C Master Writes to Slave with 7-bit Address

In all subsequent figures that illustrate I2C transactions and behavior, both the I2C Master and Slave devices are assumed to be ESP32 I2C peripheral controllers for ease of demonstration.

Figure 11-5 shows the I2C Master writing N bytes of data to an I2C Slave. According to the I2C protocol, the first byte is the Slave address. As shown in the diagram, the first byte of the RAM unit has been populated with the Slave's 7-bit address plus the 1-bit read/write flag. In this case, the flag is zero, indicating a write operation. The rest of the RAM unit holds N bytes of data ready for transmission. The cmd unit has been populated with the sequence of commands for the operation.

For the I2C master to begin an operation, the bus must not be busy, i.e. the SCL line must not be pulled low by another device on the I2C bus. The I2C operation can only begin when the SCL line is released (made high) to indicate that the I2C bus is free. After the cmd unit and data are prepared, I2C\_TRANS\_START bit in I2C\_CTR\_REG must be set to begin the configured I2C Master operation. The I2C Master then initiates a START condition on the bus and progresses to the WRITE command which will fetch N+1 bytes from RAM and send them to the Slave. The first of these bytes is the address byte.

When the transmitted data size exceeds I2C\_NONFIFO\_TX\_THRES, an I2C\_TX\_SEND\_EMPTY\_INT interrupt will be generated. After detecting the interrupt, software can read TXFIFO\_END\_ADDR in register RXFIFO\_ST\_REG, get the last address of the data in the RAM and refresh the old data in the RAM. TXFIFO\_END\_ADDR will be refreshed each time interrupt I2C\_TX\_SEND\_EMPTY\_INT or I2C\_TRANS\_COMPLETE\_INT occurs.

When ack\_check\_en is set to 1, the Master will check the ACK value each time it sends a data byte. If the ACK value received does not match ack\_exp (the expected ACK value) in the WRITE command, then the Master will generate an I2C\_ACK\_ERR\_INT interrupt and stop the transmission.

During transmission, when the SCL is high, if the input value and output value of SDA do not match, then the Master will generate an I2C\_ARBITRATION\_LOST\_INT interrupt. When the transmission is finished, the Master will generate an I2C\_TRANS\_COMPLETE\_INT interrupt.

After detecting the START bit sent from the Master, the Slave will start receiving the address and comparing it to its own. If the address does not match I2C\_SLAVE\_ADDR, then the Slave will ignore the rest of the transmission. If they do match, the Slave will store the rest of the data into RAM in the receiving order. When the data size exceeds I2C\_NONFIFO\_RX\_THRES, an I2C\_RX\_REC\_FULL\_INT interrupt is generated. After detecting the

interrupt, software will get the starting and ending addresses in the RAM by reading RXFIFO\_START\_ADDR and RXFIFO\_END\_ADDR bits in register RXFIFO\_ST\_REG, and fetch the data for further processing. Register RXFIFO\_START\_ADDR is refreshed only once during each transmission, while RXFIFO\_END\_ADDR gets refreshed every time when either I2C\_RX\_REC\_FULL\_INT or I2C\_TRANS\_COMPLETE\_INT interrupt is generated.

When the END command is not used, the I2C master can transmit up to  $(14 \times 255 - 1)$  bytes of valid data, and the cmd unit is populated with RSTART + 14 WRITE + 1 STOP.

There are several special cases to be noted:

- If the Master fails to send a STOP bit, because the SDA is pulled low by other devices, then the Master needs to be reset.
- If the Master fails to send a START bit, because the SDA or SCL is pulled low by other devices, then the Master needs to be reset. It is recommended that the software uses a timeout period to implement the reset.
- If the SDA is pulled low by the Slave during transmission, the Master can simply release it by sending it nine SCL clock signals at the most.

It is important to note that the behaviour of another I2C master or slave device on the bus may not always be similar to that of the ESP32 I2C peripheral in the master- or slave-mode operation described above. Please consult the datasheets of the respective I2C devices to ensure proper operation under all bus conditions.

The ESP32 I2C controller uses 7-bit addressing by default. However, 10-bit addressing can also be used. In the master, this is done by sending a second I2C address byte after the first address byte. In the slave, the I2C\_SLAVE\_ADDR\_10BIT\_EN bit in I2C\_SLAVE\_ADDR\_REG can be set to activate a 10-bit addressing mode. I2C\_SLAVE\_ADDR is used to configure the I2C Slave address, as per usual. Figure 11-6 shows the equivalent of I2C Master operation writing N-bytes of data to an I2C Slave with a 10-bit address. Since 10-bit Slave addresses require an extra address byte, both the byte\_num field of the WRITE command and the number of total bytes in RAM increase by one.

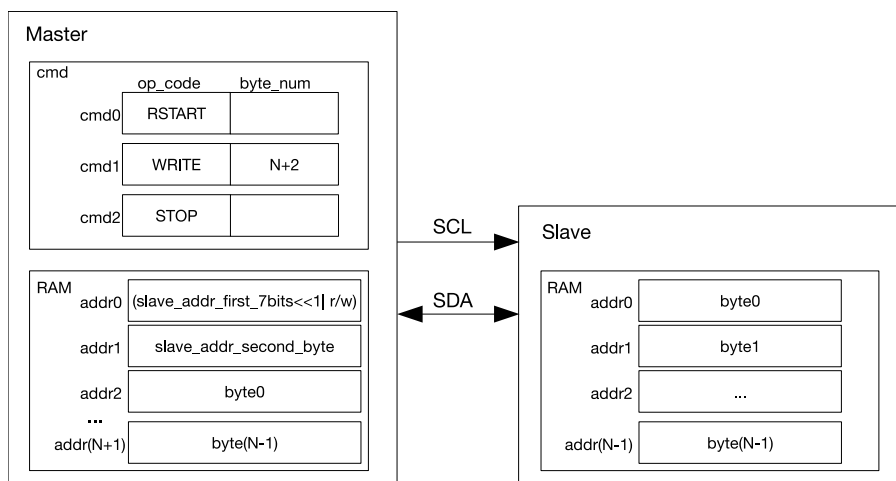
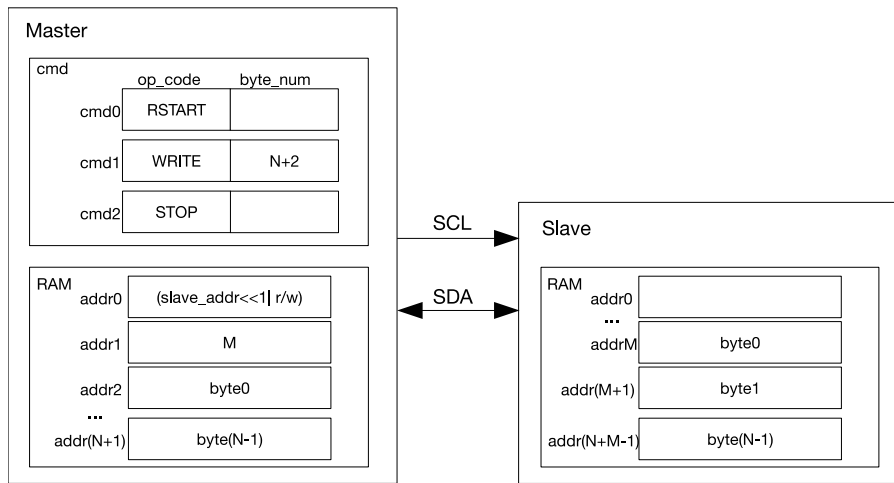


Figure 11-6. I2C Master Writes to Slave with 10-bit Address

When the END command is not used, the I2C master can transmit up to  $(14 \times 255 - 2)$  bytes of valid data to Slave with 10-bit address.

One way many I2C Slave devices are designed is by exposing a register block containing various settings. The I2C Master can write one or more of these registers by sending the Slave a register address. The ESP32 I2C Slave controller has hardware support for such a scheme.

Specifically, on the Slave, I2C\_FIFO\_ADDR\_CFG\_EN can be set so that the I2C Master can write to a specified register address inside the I2C Slave memory block. Figure 11-7 shows the Master writing N-bytes of data byte0 ~ byte(N-1) from the RAM unit to register address M (determined by addrM in RAM unit) with the Slave. In this mode, Slave can receive up to 32 bytes of valid data. When Master needs to transmit extra amount of data, segmented transmission can be enabled.



**Figure 11-7. I2C Master Writes to addrM in RAM of Slave with 7-bit Address**

If the data size exceeds the capacity of a 14-byte read/write cmd, the END command can be called to enable segmented transmission. Figure 11-8 shows the Master writing data to the Slave, in three segments. The first segment shows the configuration of the Master's commands and the preparation of data in the RAM unit. When the I2C\_TRANS\_START bit is enabled, the Master starts transmission. After executing the END command, the Master will turn off the SCL clock and pull the SCL low to reserve the bus and prevent any other device from transacting on the bus. The controller will generate an I2C\_END\_DETECT\_INT interrupt to notify the software.

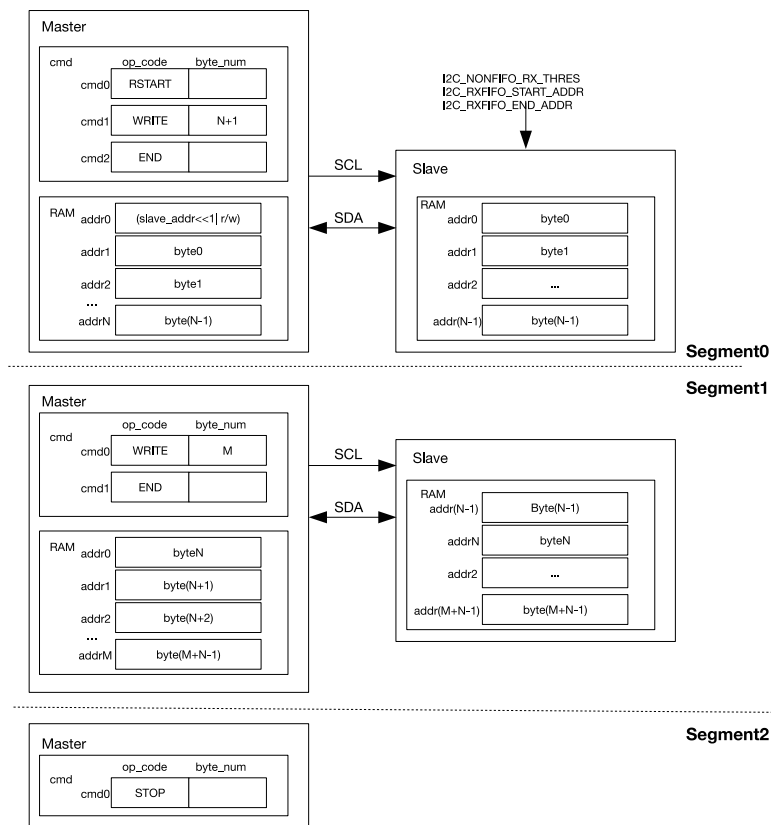


Figure 11-8. Master Writes to Slave with 7-bit Address in Three Segments

After detecting an I2C\_END\_DETECT\_INT interrupt, the software can refresh the contents of the cmd and RAM blocks, as shown in the second segment. Subsequently, it should clear the I2C\_END\_DETECT\_INT interrupt and resume the transaction by setting the I2C\_TRANS\_START bit. To stop the transaction, it should configure the cmd, as the third segment shows, and enable the I2C\_TRANS\_START bit to generate a STOP bit, after detecting the I2C\_END\_DETECT\_INT interrupt.

Please note that the other masters on the bus will be starved of bus time between two segments. The bus is only released after a STOP signal is sent.

**Note:** When there are more than three segments, the address of an END command in the cmd should not be altered into another command by the next segment.

### 11.3.6 Master Reads from Slave

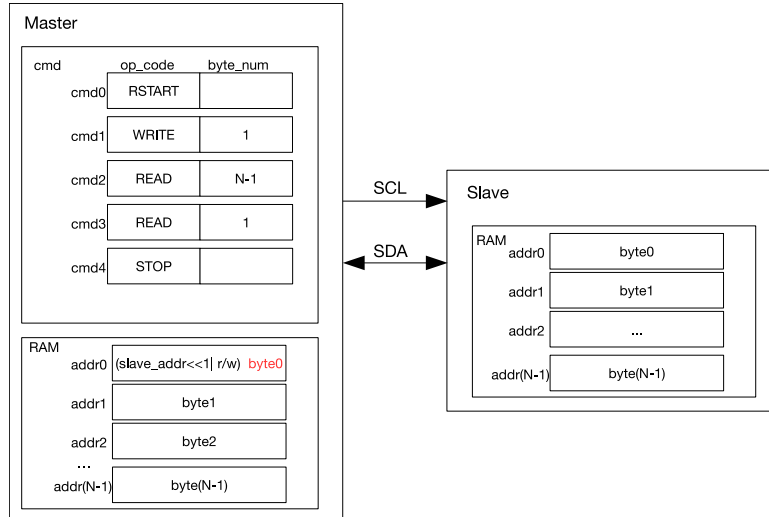


Figure 11-9. Master Reads from Slave with 7-bit Address

Figure 11-9 shows the Master reading N-bytes of data from an Slave with a 7-bit address. At first, the Master needs to send the address of the Slave, so cmd1 is a WRITE command. The byte that this command sends is the slave address plus the R/W flag, which in this case is 1 and, therefore, indicates that this is going to be a read operation. The Slave starts to send data to the Master if the addresses match. The Master will return ACK, according to the ack\_value in the READ command, upon receiving every byte. As can be seen from Figure 11-9, READ is divided into two segments. The Master replies ACK to N-1 bytes in cmd2 and does not reply ACK to the single byte READ command in cmd3, i.e., the last transmitted data. Users can configure it as they wish.

When storing the received data, Master will start from the first address in RAM. Byte0 (Slave address + 1-bit R/W marker bit) will be overwritten.

When the END command is not used, the Master can receive up to (13\*255) bytes of valid data. The cmd unit is populated with RSTART + 1 WRITE + 13 READ + 1 STOP.

Figure 11-10 shows the Master reading data from a slave with a 10-bit address. This mode can be enabled by setting I2C\_SLAVE\_ADDR\_10BIT\_EN bit and preparing data to be sent in the slave RAM. In the Master, two bytes of RAM are used for a 10-bit address. Finally, the I2C\_TRANS\_START bit must be set to enable one transaction.

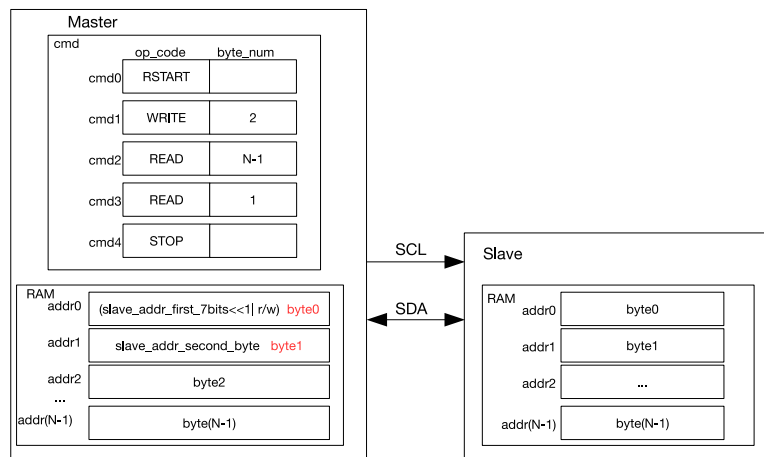


Figure 11-10. Master Reads from Slave with 10-bit Address

Figure 11-11 shows the Master reading data from a specified address in the Slave. This mode can be enabled by setting `I2C_FIFO_ADDR_CFG_EN` and preparing the data to be read by the master in the Slave RAM block. Subsequently, the address of the Slave and the address of the specified register (that is, M) have to be determined by the master. Finally, the `I2C_TRANS_START` bit must be set in the Master to initiate the read operation, following which the Slave will fetch N bytes of data from RAM and send them to the Master.

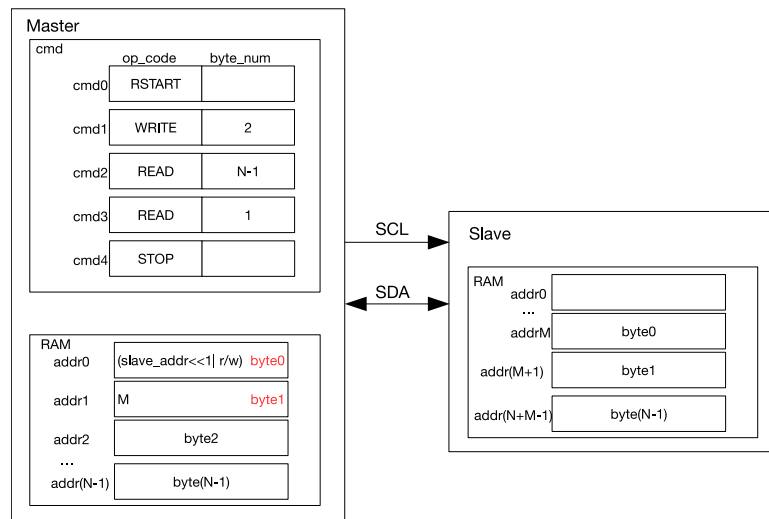


Figure 11-11. Master Reads N Bytes of Data from addrM in Slave with 7-bit Address

Figure 11-12 shows the Master reading N+M bytes of data in three segments from the Slave. The first segment shows the configuration of the cmd and the preparation of data in the Slave RAM. When the `I2C_TRANS_START` bit is enabled, the Master starts the operation. The Master will refresh the cmd after executing the END command. It will clear the `I2C_END_DETECT_INT` interrupt, set the `I2C_TRANS_START` bit and resume the transaction. To stop the transaction, the Master will configure the cmd, as the third segment shows, after detecting the `I2C_END_DETECT_INT` interrupt. After setting the `I2C_TRANS_START` bit, Master will send a STOP bit to stop the transaction.

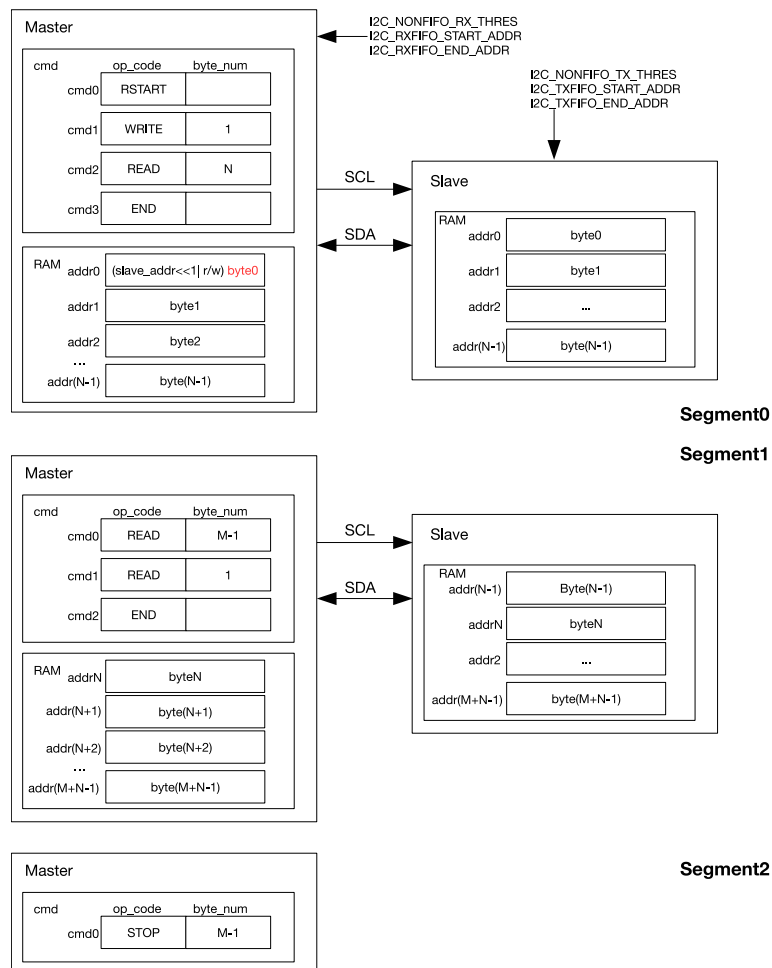


Figure 11-12. Master Reads from Slave with 7-bit Address in Three Segments

### 11.3.7 Interrupts

- I2C\_TX\_SEND\_EMPTY\_INT: Triggered when the Master or Slave has sent nonfifo\_tx\_thres bytes of data.
- I2C\_RX\_REC\_FULL\_INT: Triggered when the Master or Slave has received nonfifo\_rx\_thres bytes of data.
- I2C\_ACK\_ERR\_INT: Triggered when the Master receives an ACK that is not as expected, or when the Slave receives an ACK whose value is 1.
- I2C\_TRANS\_START\_INT: Triggered when the Master or Slave sends the START bit.
- I2C\_TIME\_OUT\_INT: Triggered when the SCL stays high or low for more than I2C\_TIME\_OUT clocks.
- I2C\_TRANS\_COMPLETE\_INT: Triggered when the Master or Slave detects a STOP bit.
- I2C\_MASTER\_TRAN\_COMP\_INT: Triggered when the Master sends or receives a byte.
- I2C\_ARBITRATION\_LOST\_INT: Triggered when the Master's SCL is high, while the output value and input value of the SDA do not match.
- I2C\_END\_DETECT\_INT: Triggered when the Master deals with the END command.



## 11.4 Register Summary

Name	Description	I2C0	I2C1	Acc
<b>Configuration registers</b>				
I2C_SLAVE_ADDR_REG	Configures the I2C slave address	0x3FF53010	0x3FF67010	R/W
I2C_RXFIFO_ST_REG	FIFO status register	0x3FF53014	0x3FF67014	RO
I2C_FIFO_CONF_REG	FIFO configuration register	0x3FF53018	0x3FF67018	R/W
<b>Timing registers</b>				
I2C_SDA_HOLD_REG	Configures the hold time after a negative SCL edge	0x3FF53030	0x3FF67030	R/W
I2C_SDA_SAMPLE_REG	Configures the sample time after a positive SCL edge	0x3FF53034	0x3FF67034	R/W
I2C_SCL_LOW_PERIOD_REG	Configures the low level width of the SCL clock	0x3FF53000	0x3FF67000	R/W
I2C_SCL_HIGH_PERIOD_REG	Configures the high level width of the SCL clock	0x3FF53038	0x3FF67038	R/W
I2C_SCL_START_HOLD_REG	Configures the delay between the SDA and SCL negative edge for a start condition	0x3FF53040	0x3FF67040	R/W
I2C_SCL_RSTART_SETUP_REG	Configures the delay between the positive edge of SCL and the negative edge of SDA	0x3FF53044	0x3FF67044	R/W
I2C_SCL_STOP_HOLD_REG	Configures the delay after the SCL clock edge for a stop condition	0x3FF53048	0x3FF67048	R/W
I2C_SCL_STOP_SETUP_REG	Configures the delay between the SDA and SCL positive edge for a stop condition	0x3FF5304C	0x3FF6704C	R/W
<b>Filter registers</b>				
I2C_SCL_FILTER_CFG_REG	SCL filter configuration register	0x3FF53050	0x3FF67050	R/W
I2C_SDA_FILTER_CFG_REG	SDA filter configuration register	0x3FF53054	0x3FF67054	R/W
<b>Interrupt registers</b>				
I2C_INT_RAW_REG	Raw interrupt status	0x3FF53020	0x3FF67020	RO
I2C_INT_CLR_REG	Interrupt clear bits	0x3FF53024	0x3FF67024	WO
I2C_INT_ENA_REG	Interrupt enable bits	0x3FF53028	0x3FF67028	R/W
I2C_INT_STATUS_REG	Interrupt status bits	0x3FF5302C	0x3FF6702C	RO
<b>Command registers</b>				
I2C_COMD0_REG	I2C command register 0	0x3FF53058	0x3FF67058	R/W
I2C_COMD1_REG	I2C command register 1	0x3FF5305C	0x3FF6705C	R/W
I2C_COMD2_REG	I2C command register 2	0x3FF53060	0x3FF67060	R/W
I2C_COMD3_REG	I2C command register 3	0x3FF53064	0x3FF67064	R/W
I2C_COMD4_REG	I2C command register 4	0x3FF53068	0x3FF67068	R/W
I2C_COMD5_REG	I2C command register 5	0x3FF5306C	0x3FF6706C	R/W
I2C_COMD6_REG	I2C command register 6	0x3FF53070	0x3FF67070	R/W
I2C_COMD7_REG	I2C command register 7	0x3FF53074	0x3FF67074	R/W
I2C_COMD8_REG	I2C command register 8	0x3FF53078	0x3FF67078	R/W
I2C_COMD9_REG	I2C command register 9	0x3FF5307C	0x3FF6707C	R/W
I2C_COMD10_REG	I2C command register 10	0x3FF53080	0x3FF67080	R/W
I2C_COMD11_REG	I2C command register 11	0x3FF53084	0x3FF67084	R/W

---

Name	Description	I2C0	I2C1	Acc
<a href="#">I2C_COMD12_REG</a>	I2C command register 12	0x3FF53088	0x3FF67088	R/W
<a href="#">I2C_COMD13_REG</a>	I2C command register 13	0x3FF5308C	0x3FF6708C	R/W
<a href="#">I2C_COMD14_REG</a>	I2C command register 14	0x3FF53090	0x3FF67090	R/W
<a href="#">I2C_COMD15_REG</a>	I2C command register 15	0x3FF53094	0x3FF67094	R/W



**Register 11.3. I2C\_SR\_REG (0x0008)**

(reserved)				I2C_SCL_STATE_LAST				(reserved)				I2C_SCL_MAIN_STATE_LAST				I2C_TXFIFO_CNT				(reserved)				I2C_RXFIFO_CNT				(reserved)				I2C_BYTE_TRANS				I2C_SLAVE_ADDRESSED				I2C_BUS_BUSY				I2C_ARB_LOST				I2C_TIME_OUT				I2C_SLAVE_RW				I2C_ACK_REC			
31	30	28	27	26	24	23	18	17	14	13	8	7	6	5	4	3	2	1	0	31	30	28	27	26	24	23	18	17	14	13	8	7	6	5	4	3	2	1	0																				
0	0	0	0	0	0	0	0	0	0	0	0	0	0	0	0	0	0	0	0	0	0	0	0	0	0	0	0	0	0	0	0	0	0	0	0	0	0	0	0	0																			

**I2C\_SCL\_STATE\_LAST** This field indicates the states of the state machine used to produce SCL. (RO)  
 0: Idle; 1: Start; 2: Negative edge; 3: Low; 4: Positive edge; 5: High; 6: Stop

**I2C\_SCL\_MAIN\_STATE\_LAST** This field indicates the states of the I2C module state machine. (RO)  
 0: Idle; 1: Address shift; 2: ACK address; 3: Rx data; 4: Tx data; 5: Send ACK; 6: Wait ACK

**I2C\_TXFIFO\_CNT** This field stores the amount of received data in RAM. (RO)

**I2C\_RXFIFO\_CNT** This field represents the amount of data needed to be sent. (RO)

**I2C\_BYTE\_TRANS** This field changes to 1 when one byte is transferred. (RO)

**I2C\_SLAVE\_ADDRESSED** When configured as an I2C Slave, and the address sent by the master is equal to the address of the slave, then this bit will be of high level. (RO)

**I2C\_BUS\_BUSY** 1: the I2C bus is busy transferring data; 0: the I2C bus is in idle state. (RO)

**I2C\_ARB\_LOST** When the I2C controller loses control of SCL line, this register changes to 1. (RO)

**I2C\_TIME\_OUT** When the I2C controller takes more than I2C\_TIME\_OUT clocks to receive a data bit, this field changes to 1. (RO)

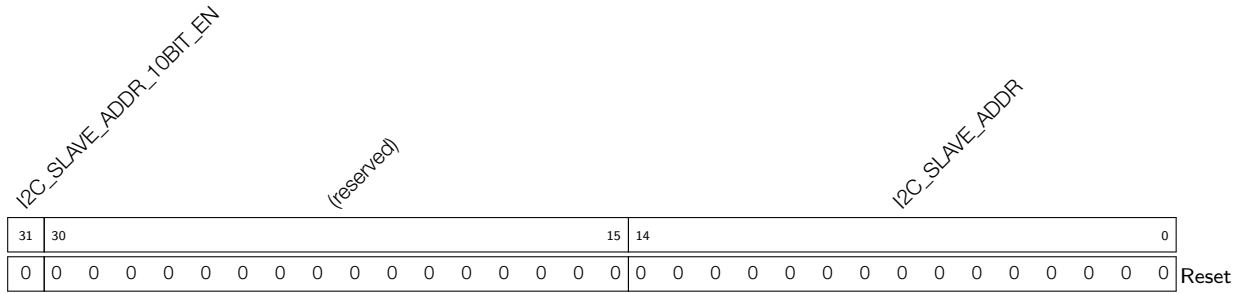
**I2C\_SLAVE\_RW** When in slave mode, 1: master reads from slave; 0: master writes to slave. (RO)

**I2C\_ACK\_REC** This register stores the value of the received ACK bit. (RO)

**Register 11.4. I2C\_TO\_REG (0x000c)**

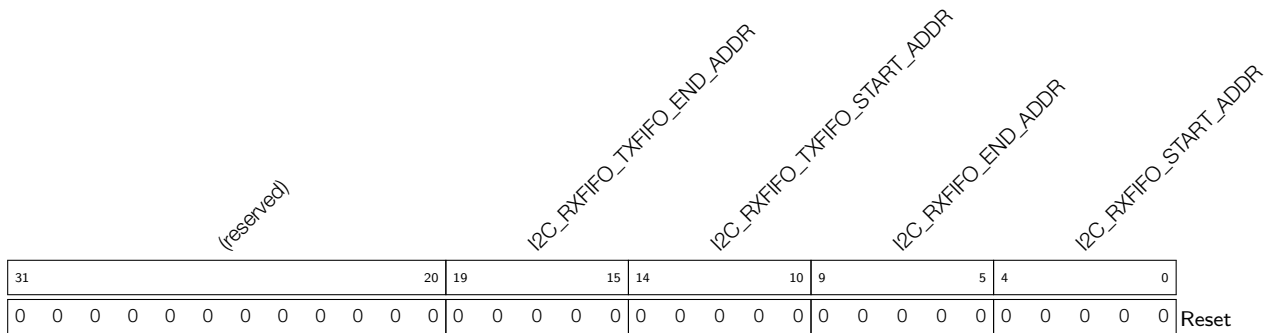
(reserved)												I2C_TIME_OUT_REG																		
31	20	19	0	31	30	28	27	26	24	23	18	17	14	13	8	7	6	5	4	3	2	1	0							
0	0	0	0	0	0	0	0	0	0	0	0	0	0	0	0	0	0	0	0	0	0	0	0	0						

**I2C\_TIME\_OUT\_REG** This register is used to configure the timeout for receiving a data bit in APB clock cycles. (R/W)

**Register 11.5. I2C\_SLAVE\_ADDR\_REG (0x0010)**

**I2C\_SLAVE\_ADDR\_10BIT\_EN** This field is used to enable the slave 10-bit addressing mode in master mode. (R/W)

**I2C\_SLAVE\_ADDR** When configured as an I2C Slave, this field is used to configure the slave address. (R/W)

**Register 11.6. I2C\_RXFIFO\_ST\_REG (0x0014)**

**I2C\_TXFIFO\_END\_ADDR** This is the offset address of the last sent data, as described in `nonfifo_tx_thres` register. The value refreshes when `I2C_TX_SEND_EMPTY_INT` or `I2C_TRANS_COMPLETE_INT` interrupt is generated. (RO)

**I2C\_TXFIFO\_START\_ADDR** This is the offset address of the first sent data, as described in `nonfifo_tx_thres` register. (RO)

**I2C\_RXFIFO\_END\_ADDR** This is the offset address of the last received data, as described in `nonfifo_rx_thres_register`. This value refreshes when `I2C_RX_REC_FULL_INT` or `I2C_TRANS_COMPLETE_INT` interrupt is generated. (RO)

**I2C\_RXFIFO\_START\_ADDR** This is the offset address of the last received data, as described in `nonfifo_rx_thres_register`. (RO)

## Register 11.7. I2C\_FIFO\_CONF\_REG (0x0018)

(reserved)						I2C_NONFIFO_TX_THRES					I2C_NONFIFO_RX_THRES					(reserved)		I2C_FIFO_ADDR_CFG_EN		I2C_NONFIFO_EN																								
31						26						25						20						19						14			13			12			11			10		
0 0 0 0 0 0						0x15					0x15					0 0		0 0		0 0		0 0		0 0		0 0		0 0		0 0		0 0		0 0		Reset								

**I2C\_NONFIFO\_TX\_THRES** When I2C sends more than nonfifo\_tx\_thres bytes of data, it will generate a tx\_send\_empty\_int\_raw interrupt and update the current offset address of the sent data. (R/W)

**I2C\_NONFIFO\_RX\_THRES** When I2C receives more than nonfifo\_rx\_thres bytes of data, it will generate a rx\_send\_full\_int\_raw interrupt and update the current offset address of the received data. (R/W)

**I2C\_FIFO\_ADDR\_CFG\_EN** When this bit is set to 1, the byte received after the I2C address byte represents the offset address in the I2C Slave RAM. (R/W)

**I2C\_NONFIFO\_EN** Set this bit to enable APB nonfifo access. (R/W)

## Register 11.8. I2C\_INT\_RAW\_REG (0x0020)

(reserved)													I2C_TX_SEND_EMPTY_INT_RAW I2C_RX_REC_FULL_INT_RAW I2C_ACK_ERR_INT_RAW I2C_TRANS_START_INT_RAW I2C_TIME_OUT_INT_RAW I2C_TRANS_COMPLETE_INT_RAW I2C_MASTER_TRAN_COMP_INT_RAW I2C_ARBITRATION_LOST_INT_RAW I2C_END_DETECT_INT_RAW										
31													13	12	11	10	9	8	7	6	5	3	Reset
0													0								0		

**I2C\_TX\_SEND\_EMPTY\_INT\_RAW** The raw interrupt status bit for the [I2C\\_TX\\_SEND\\_EMPTY\\_INT](#) interrupt. (RO)

**I2C\_RX\_REC\_FULL\_INT\_RAW** The raw interrupt status bit for the [I2C\\_RX\\_REC\\_FULL\\_INT](#) interrupt. (RO)

**I2C\_ACK\_ERR\_INT\_RAW** The raw interrupt status bit for the [I2C\\_ACK\\_ERR\\_INT](#) interrupt. (RO)

**I2C\_TRANS\_START\_INT\_RAW** The raw interrupt status bit for the [I2C\\_TRANS\\_START\\_INT](#) interrupt. (RO)

**I2C\_TIME\_OUT\_INT\_RAW** The raw interrupt status bit for the [I2C\\_TIME\\_OUT\\_INT](#) interrupt. (RO)

**I2C\_TRANS\_COMPLETE\_INT\_RAW** The raw interrupt status bit for the [I2C\\_TRANS\\_COMPLETE\\_INT](#) interrupt. (RO)

**I2C\_MASTER\_TRAN\_COMP\_INT\_RAW** The raw interrupt status bit for the [I2C\\_MASTER\\_TRAN\\_COMP\\_INT](#) interrupt. (RO)

**I2C\_ARBITRATION\_LOST\_INT\_RAW** The raw interrupt status bit for the [I2C\\_ARBITRATION\\_LOST\\_INT](#) interrupt. (RO)

**I2C\_END\_DETECT\_INT\_RAW** The raw interrupt status bit for the [I2C\\_END\\_DETECT\\_INT](#) interrupt. (RO)

## Register 11.9. I2C\_INT\_CLR\_REG (0x0024)

(reserved)													I2C_TX_SEND_EMPTY_INT_CLR I2C_RX_REC_FULL_INT_CLR I2C_ACK_ERR_INT_CLR I2C_TRANS_START_INT_CLR I2C_TIME_OUT_INT_CLR I2C_TRANS_COMPLETE_INT_CLR I2C_MASTER_TRAN_COMP_INT_CLR I2C_ARBITRATION_LOST_INT_CLR I2C_END_DETECT_INT_CLR									
31												13	12	11	10	9	8	7	6	5	3	Reset
0	0	0	0	0	0	0	0	0	0	0	0	0	0	0	0	0	0	0	0	0	0	

**I2C\_TX\_SEND\_EMPTY\_INT\_CLR** Set this bit to clear the [I2C\\_TX\\_SEND\\_EMPTY\\_INT](#) interrupt. (WO)

**I2C\_RX\_REC\_FULL\_INT\_CLR** Set this bit to clear the [I2C\\_RX\\_REC\\_FULL\\_INT](#) interrupt. (WO)

**I2C\_ACK\_ERR\_INT\_CLR** Set this bit to clear the [I2C\\_ACK\\_ERR\\_INT](#) interrupt. (WO)

**I2C\_TRANS\_START\_INT\_CLR** Set this bit to clear the [I2C\\_TRANS\\_START\\_INT](#) interrupt. (WO)

**I2C\_TIME\_OUT\_INT\_CLR** Set this bit to clear the [I2C\\_TIME\\_OUT\\_INT](#) interrupt. (WO)

**I2C\_TRANS\_COMPLETE\_INT\_CLR** Set this bit to clear the [I2C\\_TRANS\\_COMPLETE\\_INT](#) interrupt. (WO)

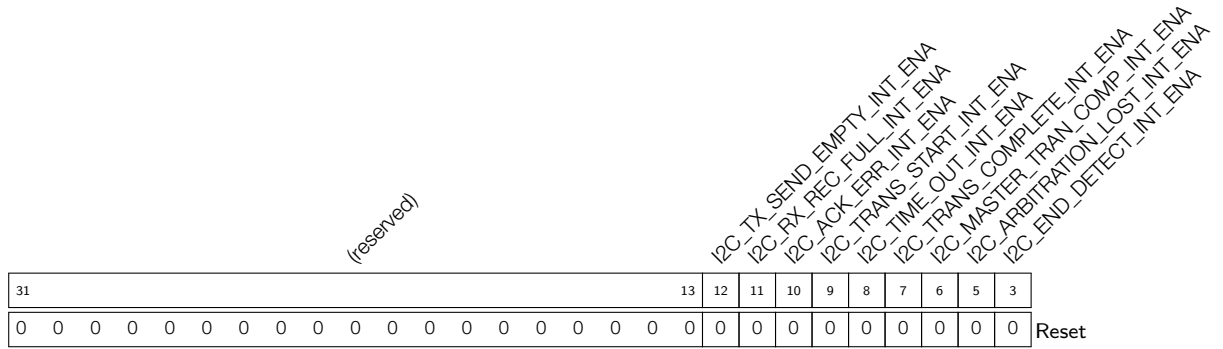
**I2C\_MASTER\_TRAN\_COMP\_INT\_CLR** Set this bit to clear the [I2C\\_MASTER\\_TRAN\\_COMP\\_INT](#) interrupt. (WO)

**I2C\_ARBITRATION\_LOST\_INT\_CLR** Set this bit to clear the [I2C\\_ARBITRATION\\_LOST\\_INT](#) interrupt. (WO)

**I2C\_END\_DETECT\_INT\_CLR** Set this bit to clear the [I2C\\_END\\_DETECT\\_INT](#) interrupt. (WO)



**Register 11.10. I2C\_INT\_ENA\_REG (0x0028)**



**I2C\_TX\_SEND\_EMPTY\_INT\_ENA** The interrupt enable bit for the [I2C\\_TX\\_SEND\\_EMPTY\\_INT](#) interrupt. (R/W)

**I2C\_RX\_REC\_FULL\_INT\_ENA** The interrupt enable bit for the [I2C\\_RX\\_REC\\_FULL\\_INT](#) interrupt. (R/W)

**I2C\_ACK\_ERR\_INT\_ENA** The interrupt enable bit for the [I2C\\_ACK\\_ERR\\_INT](#) interrupt. (R/W)

**I2C\_TRANS\_START\_INT\_ENA** The interrupt enable bit for the [I2C\\_TRANS\\_START\\_INT](#) interrupt. (R/W)

**I2C\_TIME\_OUT\_INT\_ENA** The interrupt enable bit for the [I2C\\_TIME\\_OUT\\_INT](#) interrupt. (R/W)

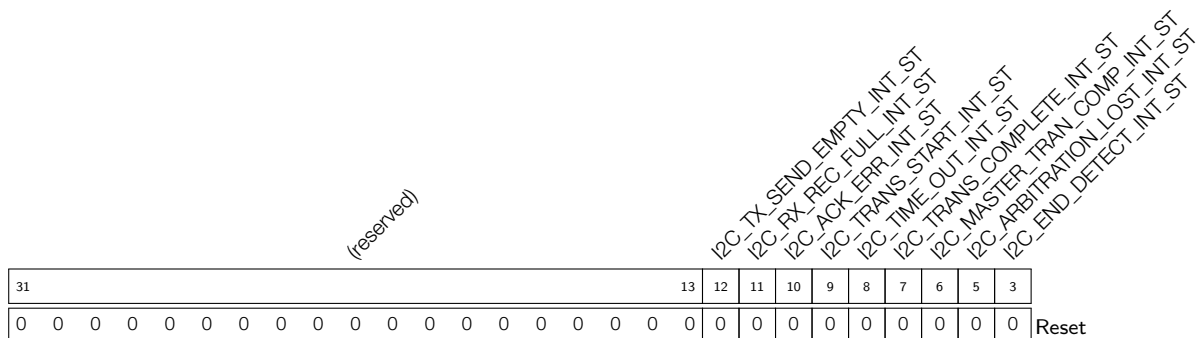
**I2C\_TRANS\_COMPLETE\_INT\_ENA** The interrupt enable bit for the [I2C\\_TRANS\\_COMPLETE\\_INT](#) interrupt. (R/W)

**I2C\_MASTER\_TRAN\_COMP\_INT\_ENA** The interrupt enable bit for the [I2C\\_MASTER\\_TRAN\\_COMP\\_INT](#) interrupt. (R/W)

**I2C\_ARBITRATION\_LOST\_INT\_ENA** The interrupt enable bit for the [I2C\\_ARBITRATION\\_LOST\\_INT](#) interrupt. (R/W)

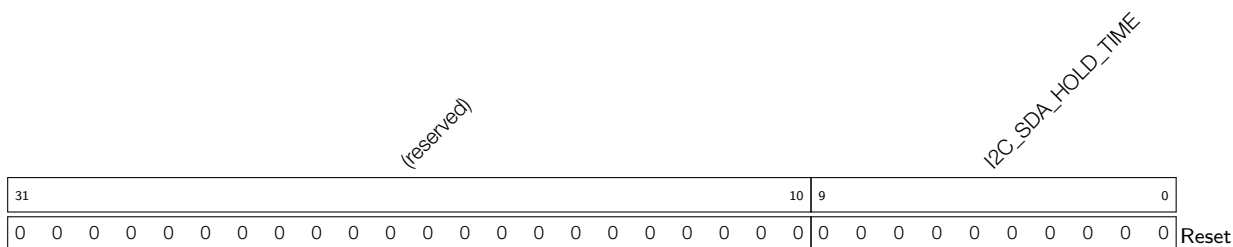
**I2C\_END\_DETECT\_INT\_ENA** The interrupt enable bit for the [I2C\\_END\\_DETECT\\_INT](#) interrupt. (R/W)

**Register 11.11. I2C\_INT\_STATUS\_REG (0x002c)**

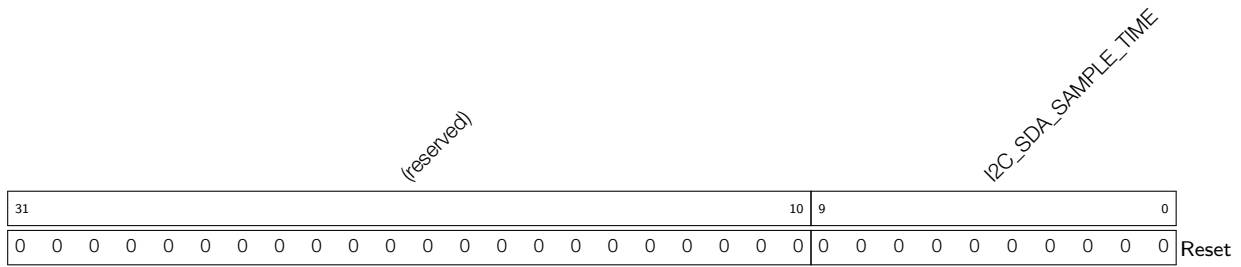


- I2C\_TX\_SEND\_EMPTY\_INT\_ST** The masked interrupt status bit for the [I2C\\_TX\\_SEND\\_EMPTY\\_INT](#) interrupt. (RO)
- I2C\_RX\_REC\_FULL\_INT\_ST** The masked interrupt status bit for the [I2C\\_RX\\_REC\\_FULL\\_INT](#) interrupt. (RO)
- I2C\_ACK\_ERR\_INT\_ST** The masked interrupt status bit for the [I2C\\_ACK\\_ERR\\_INT](#) interrupt. (RO)
- I2C\_TRANS\_START\_INT\_ST** The masked interrupt status bit for the [I2C\\_TRANS\\_START\\_INT](#) interrupt. (RO)
- I2C\_TIME\_OUT\_INT\_ST** The masked interrupt status bit for the [I2C\\_TIME\\_OUT\\_INT](#) interrupt. (RO)
- I2C\_TRANS\_COMPLETE\_INT\_ST** The masked interrupt status bit for the [I2C\\_TRANS\\_COMPLETE\\_INT](#) interrupt. (RO)
- I2C\_MASTER\_TRAN\_COMP\_INT\_ST** The masked interrupt status bit for the [I2C\\_MASTER\\_TRAN\\_COMP\\_INT](#) interrupt. (RO)
- I2C\_ARBITRATION\_LOST\_INT\_ST** The masked interrupt status bit for the [I2C\\_ARBITRATION\\_LOST\\_INT](#) interrupt. (RO)
- I2C\_END\_DETECT\_INT\_ST** The masked interrupt status bit for the [I2C\\_END\\_DETECT\\_INT](#) interrupt. (RO)

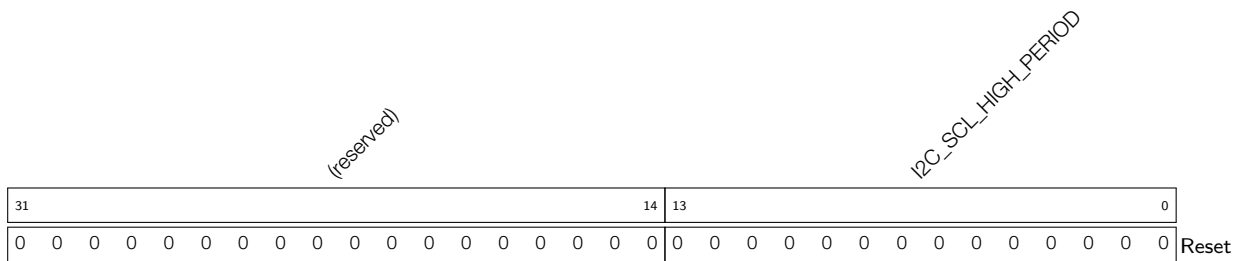
**Register 11.12. I2C\_SDA\_HOLD\_REG (0x0030)**



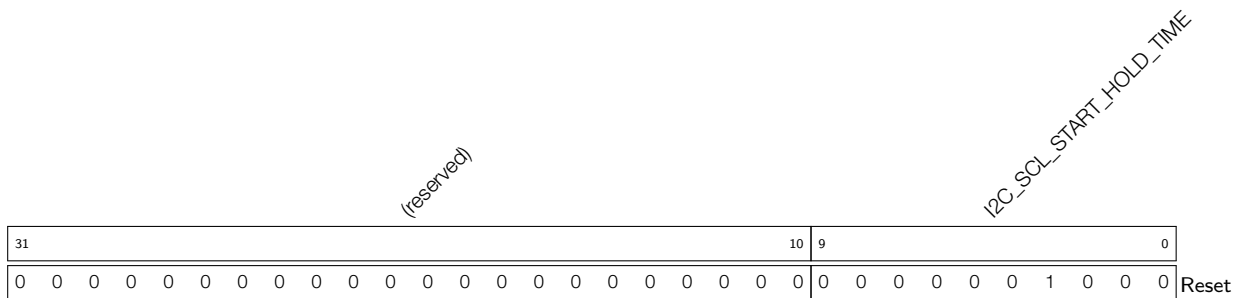
**I2C\_SDA\_HOLD\_TIME** This register is used to configure the time to hold the data after the negative edge of SCL, in APB clock cycles. (R/W)

**Register 11.13. I2C\_SDA\_SAMPLE\_REG (0x0034)**

**I2C\_SDA\_SAMPLE\_TIME** This register is used to configure for how long SDA is sampled, in APB clock cycles. (R/W)

**Register 11.14. I2C\_SCL\_HIGH\_PERIOD\_REG (0x0038)**

**I2C\_SCL\_HIGH\_PERIOD** This register is used to configure for how long SCL remains high in master mode, in APB clock cycles. (R/W)

**Register 11.15. I2C\_SCL\_START\_HOLD\_REG (0x0040)**

**I2C\_SCL\_START\_HOLD\_TIME** This register is used to configure the time between the negative edge of SDA and the negative edge of SCL for a START condition, in APB clock cycles. (R/W)





## 12 I2S Controller (I2S)

### 12.1 Overview

The I2S bus provides a flexible communication interface for streaming digital data in multimedia applications, especially digital audio applications. The ESP32 includes two I2S interfaces: I2S0 and I2S1.

The I2S standard bus defines three signals: a clock signal, a channel selection signal, and a serial data signal. A basic I2S data bus has one master and one slave. The roles remain unchanged throughout the communication. The I2S modules on the ESP32 provide separate transmit and receive channels for high performance.

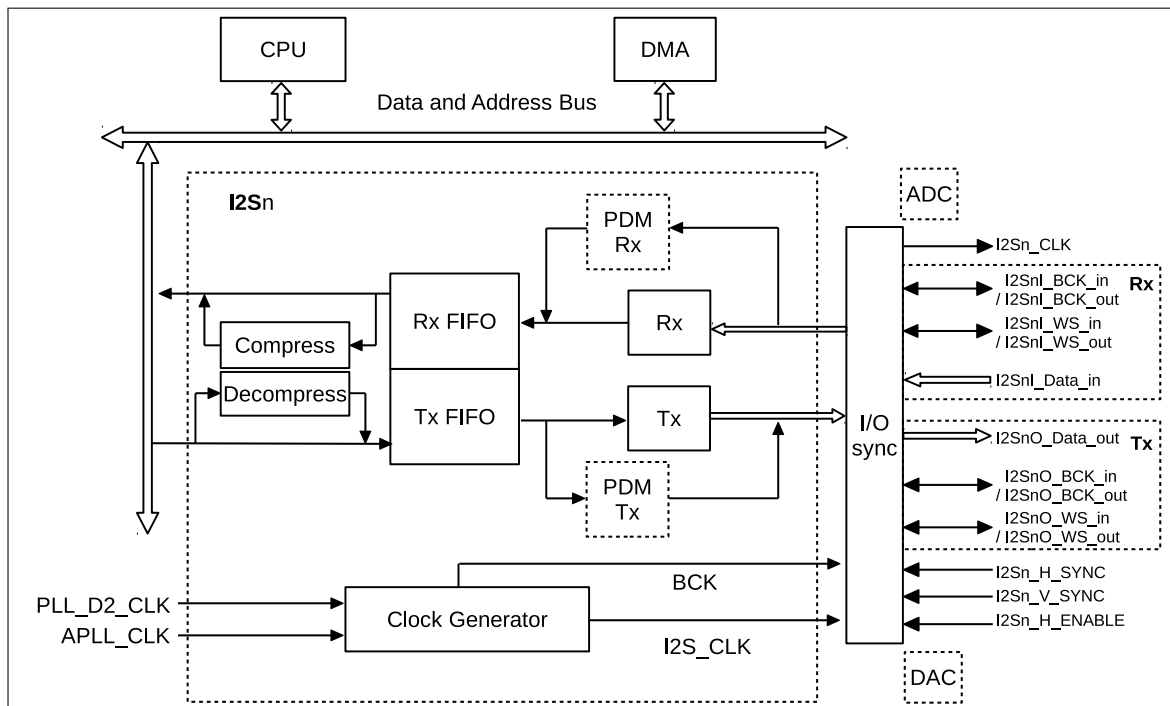


Figure 12-1. I2S System Block Diagram

Figure 12-1 is the system block diagram of the ESP32 I2S module. In the figure above, the value of "n" can be either 0 or 1. There are two independent I2S modules embedded in ESP32, namely I2S0 and I2S1. Each I2S module contains a Tx (transmit) unit and a Rx (receive) unit. Both the Tx unit and the Rx unit have a three-wire interface that includes a clock line, a channel selection line and a serial data line. The serial data line of the Tx unit is fixed as output, and the serial data line of the Rx unit is fixed as input. The clock line and the channel selection line of the Tx and Rx units can be configured to both master transmitting mode and slave receiving mode. In the LCD mode, the serial data line extends to the parallel data bus. Both the Tx unit and the Rx unit have a 32-bit-wide FIFO with a depth of 64. Besides, only I2S0 supports on-chip DAC/ADC modes, as well as receiving and transmitting PDM signals.

The right side of Figure 12-1 shows the signal bus of the I2S module. The signal naming rule of the Rx and Tx units is I2SnA\_B\_C, where "n" stands for either I2S0 or I2S1; "A" represents the direction of I2S module's data bus signal, "I" represents input, "O" represents output; "B" represents signal function; "C" represents the signal direction, "in" means that the signal is input into the I2S module, while "out" means that the I2S module outputs the signal. For a detailed description of the I2S signal bus, please refer to Table 12-1. Table 12-1 describes the signal bus of the I2S module. Except for the I2Sn\_CLK signal, all other signals are mapped to the chip pin via the

GPIO matrix and IO MUX. The I2S<sub>n</sub>\_CLK signal is mapped to the chip pin via the IO\_MUX. For details, please refer to the chapter about [IO\\_MUX and the GPIO Matrix](#).

**Table 12-1. I2S Signal Bus Description**

Signal Bus	Signal Direction	Data Signal Direction
I2S <sub>n</sub> I_BCK_in	In slave mode, I2S module inputs signals.	I2S module receives data.
I2S <sub>n</sub> I_BCK_out	In master mode, I2S module outputs signals.	I2S module receives data.
I2S <sub>n</sub> I_WS_in	In slave mode, I2S module inputs signals.	I2S module receives data.
I2S <sub>n</sub> I_WS_out	In master mode, I2S module outputs signals.	I2S module receives data.
I2S <sub>n</sub> I_Data_in <sup>1</sup>	I2S module inputs signals.	In I2S mode, I2S <sub>n</sub> I_Data_in[15] is the serial data bus of I2S. In LCD mode, the data bus width can be configured as needed.
I2S <sub>n</sub> O_Data_out <sup>1</sup>	I2S module outputs signals.	In I2S mode, I2S <sub>n</sub> O_Data_out[23] is the serial data bus of I2S. In LCD mode, the data bus width can be configured as needed.
I2S <sub>n</sub> O_BCK_in	In slave mode, I2S module inputs signals.	I2S module sends data.
I2S <sub>n</sub> O_BCK_out	In master mode, I2S module outputs signals.	I2S module sends data.
I2S <sub>n</sub> O_WS_in	In slave mode, I2S module inputs signals.	I2S module sends data.
I2S <sub>n</sub> O_WS_out	In master mode, I2S module outputs signals.	I2S module sends data.
I2S <sub>n</sub> _CLK <sup>2</sup>	I2S module outputs signals.	It is used as a clock source for peripheral chips.
I2S <sub>n</sub> _H_SYNC	In Camera mode, I2S module inputs signals.	The signals are sent from the Camera.
I2S <sub>n</sub> _V_SYNC		
I2S <sub>n</sub> _H_ENABLE		

**Note:**

1. Assume that the bit width of the input/output signal is  $N$ , the input signal should be configured to I2S<sub>n</sub>I\_Data\_in[ $N-1:0$ ], and the output signal to I2S<sub>n</sub>O\_Data\_out[23: $N+1$ ]. Generally, for input signals,  $N=8$  or 16; while for output signals,  $N=8$ , 16 or 24 (note that I2S1 does not support 24-bit width).
2. I2S<sub>n</sub>\_CLK can only be mapped to GPIO0, U0RXD (GPIO3) or U0TXD (GPIO1) by selecting GPIO functions CLK\_OUT1, CLK\_OUT2, or CLK\_OUT3. For more information, see [Table 4-3: IO\\_MUX Pad List](#).

## 12.2 Features

I2S mode

- Configurable high-precision output clock
- Full-duplex and half-duplex data transmit and receive modes
- Supports multiple digital audio standards
- Embedded A-law compression/decompression module
- Configurable clock signal

- Supports PDM signal input and output
- Configurable data transmit and receive modes

#### LCD mode

- Supports multiple LCD modes, including external LCD
- Supports external Camera
- Supports on-chip DAC/ADC modes

#### I2S interrupts

- Standard I2S interface interrupts
- I2S DMA interface interrupts

### 12.3 The Clock of I2S Module

As is shown in Figure 12-2, I2S<sub>n</sub>\_CLK, as the master clock of I2S module, is derived from the 160 MHz clock PLL\_D2\_CLK or the configurable analog PLL output clock APLL\_CLK. The serial clock (BCK) of the I2S module is derived from I2S<sub>n</sub>\_CLK. The I2S\_CLKA\_ENA bit of register I2S\_CLKM\_CONF\_REG is used to select either PLL\_D2\_CLK or APLL\_CLK as the clock source for I2S<sub>n</sub>. PLL\_D2\_CLK is used as the clock source for I2S<sub>n</sub>, by default.

#### Notice:

- When using PLL\_D2\_CLK as the clock source, it is not recommended to divide it using decimals. For high performance audio applications, the analog PLL output clock source APLL\_CLK must be used to acquire highly accurate I2S<sub>n</sub>\_CLK and BCK. For further details, please refer to the chapter entitled [Reset and Clock](#).
- When ESP32 I2S works in slave mode, the master must use I2S<sub>n</sub>\_CLK as the master clock and  $f_{i2s} \geq 8 * f_{BCK}$ .

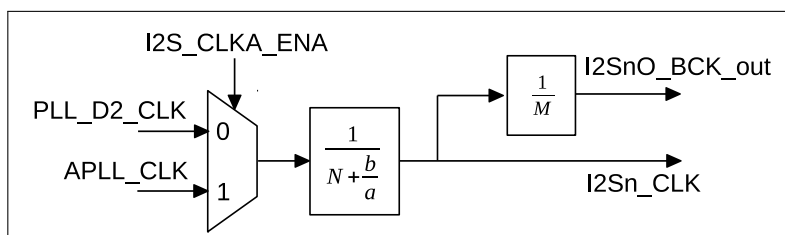


Figure 12-2. I2S Clock

The relation between I2S<sub>n</sub>\_CLK frequency  $f_{i2s}$  and the divider clock source frequency  $f_{pll}$  can be seen in the equation below:

$$f_{i2s} = \frac{f_{pll}}{N + \frac{b}{a}}$$

"N", whose value is  $\geq 2$ , corresponds to the REG\_CLKM\_DIV\_NUM [7:0] bits of register I2S\_CLKM\_CONF\_REG, "b" is the I2S\_CLKM\_DIV\_B[5:0] bit and "a" is the I2S\_CLKM\_DIV\_A[5:0] bit.

In master mode, the serial clock BCK in the I2S module is derived from I2S<sub>n</sub>\_CLK, that is:

$$f_{BCK} = \frac{f_{i2s}}{M}$$



In master transmitting mode, "M", whose value is  $\geq 2$ , is the I2S\_TX\_BCK\_DIV\_NUM[5:0] bit of register I2S\_SAMPLE\_RATE\_CONF\_REG. In master receiving mode, "M" is the I2S\_RX\_BCK\_DIV\_NUM[5:0] bit of register I2S\_SAMPLE\_RATE\_CONF\_REG.

## 12.4 I2S Mode

The ESP32 I2S module integrates an A-law compression/decompression module to enable compression/decompression of the received audio data. The RX\_PCM\_BYPASS bit and the TX\_PCM\_BYPASS bit of register I2S\_CONF1\_REG should be cleared when using the A-law compression/decompression module.

### 12.4.1 Supported Audio Standards

In the I2S bus, BCK is the serial clock, WS is the left- /right-channel selection signal (also called word select signal), and SD is the serial data signal for transmitting/receiving digital audio data. WS and SD signals in the I2S module change on the falling edge of BCK, while the SD signal can be sampled on the rising edge of BCK. If the I2S\_RX\_RIGHT\_FIRST bit and the I2S\_TX\_RIGHT\_FIRST bit of register I2S\_CONF\_REG are set to 1, the I2S module is configured to receive and transmit right-channel data first. Otherwise, the I2S module receives and transmits left-channel data first.

#### 12.4.1.1 Philips Standard

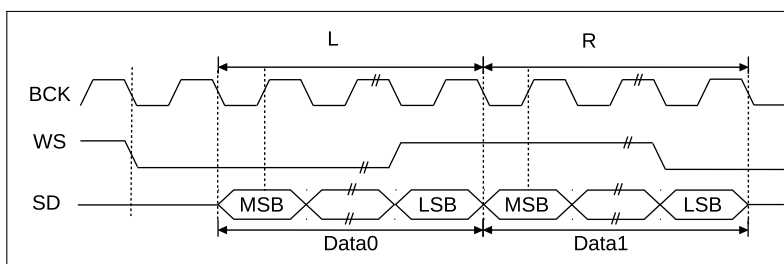


Figure 12-3. Philips Standard

As is shown in Figure 12-3, the Philips I2S bus specifications require that the WS signal starts to change one BCK clock cycle earlier than the SD signal on BCK falling edge, which means the WS signal becomes valid one clock cycle before the first bit of data transfer on the current channel, and changes one clock cycle earlier than the end of data transfer on the current channel. The SD signal line transmits the most significant bit of audio data first. If the I2S\_RX\_MSB\_SHIFT bit and the I2S\_TX\_MSB\_SHIFT bit of register I2S\_CONF\_REG are set to 1, respectively, the I2S module will use the Philips standard when receiving and transmitting data.

#### 12.4.1.2 MSB Alignment Standard

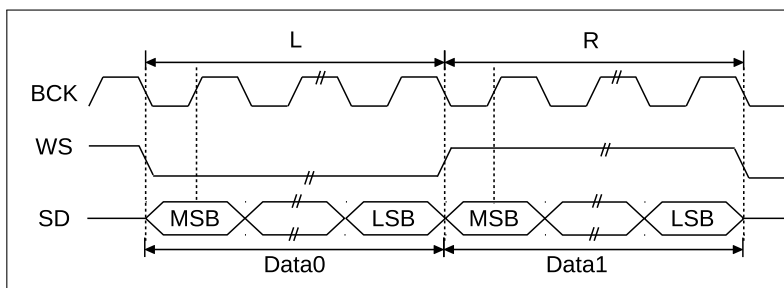


Figure 12-4. MSB Alignment Standard

The MSB alignment standard is shown in Figure 12-4. WS and SD signals both change simultaneously on the falling edge of BCK under the MSB alignment standard. The WS signal continues until the end of the current channel-data transmission, and the SD signal line transmits the most significant bit of audio data first. If the I2S\_RX\_MSB\_SHIFT and I2S\_TX\_MSB\_SHIFT bits of register I2S\_CONF\_REG are cleared, the I2S module will use the MSB alignment standard when receiving and transmitting data.

### 12.4.1.3 PCM Standard

As is shown in Figure 12-5, under the short frame synchronization mode of the PCM standard, the WS signal starts to change a BCK clock cycle earlier than the SD signal, which means that the WS signal takes effect a clock cycle earlier than the first bit of the current channel-data transmission and continues for one extra BCK clock cycle. The SD signal line transmits the most significant bit of audio data first. If the I2S\_RX\_SHORT\_SYNC and I2S\_TX\_SHORT\_SYNC bits of register I2S\_CONF\_REG are set, the I2S module will receive and transmit data in the short frame synchronization mode.

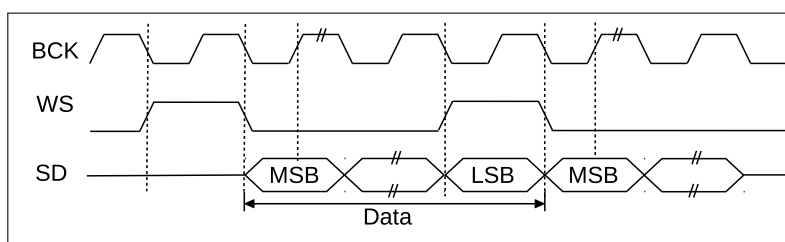


Figure 12-5. PCM Standard

### 12.4.2 Module Reset

The four low-order bits in register I2S\_CONF\_REG, that is, I2S\_TX\_RESET, I2S\_RX\_RESET, I2S\_TX\_FIFO\_RESET and I2S\_RX\_FIFO\_RESET reset the receive module, the transmit module and the corresponding FIFO buffer, respectively. In order to finish a reset operation, the corresponding bit should be set and then cleared by software.

### 12.4.3 FIFO Operation

The data read/write packet length for a FIFO operation is 32 bits. The data packet format for the FIFO buffer can be configured using configuration registers. As shown in Figure 12-1, both sent and received data should be written into FIFO first and then read from FIFO. There are two approaches to accessing the FIFO; one is to directly access the FIFO using a CPU, the other is to access the FIFO using a DMA controller.

Generally, both the I2S\_RX\_FIFO\_MOD\_FORCE\_EN bit and I2S\_TX\_FIFO\_MOD\_FORCE\_EN bits of register I2S\_FIFO\_CONF\_REG should be set to 1. I2S\_TX\_DATA\_NUM[5:0] bit and I2S\_RX\_DATA\_NUM[5:0] are used to control the length of the data that have been sent, received and buffered. Hardware inspects the received-data length RX\_LEN and the transmitted-data length TX\_LEN. Both the received and the transmitted data are buffered in the FIFO method.

When RX\_LEN is greater than I2S\_RX\_DATA\_NUM[5:0], the received data, which is buffered in FIFO, has reached the set threshold and needs to be read out to prevent an overflow. When TX\_LEN is less than I2S\_TX\_DATA\_NUM[5:0], the transmitted data, which is buffered in FIFO, has not reached the set threshold and software can continue feeding data into FIFO.

### 12.4.4 Sending Data

The ESP32 I2S module carries out a data-transmit operation in three stages:

- Read data from internal storage and transfer it to FIFO
- Read data to be sent from FIFO
- Clock out data serially, or in parallel, as configured by the user

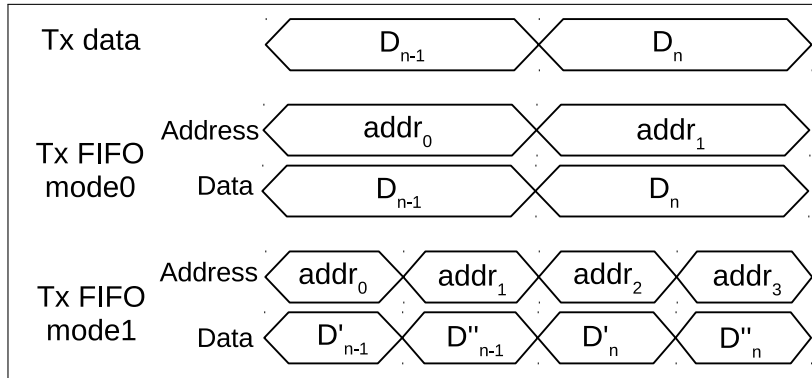


Figure 12-6. Tx FIFO Data Mode

Table 12-2. Register Configuration

	I2S_TX_FIFO_MOD[2:0]	Description
Tx FIFO mode0	0	16-bit dual channel data
	2	32-bit dual channel data
	3	32-bit single channel data
Tx FIFO mode1	1	16-bit single channel data

At the first stage, there are two modes for data to be sent and written into FIFO. In Tx FIFO mode0, the Tx data-to-be-sent are written into FIFO according to the time order. In Tx FIFO mode1, the data-to-be-sent are divided into 16 high- and 16 low-order bits. Then, both the 16 high- and 16 low-order bits are recomposed and written into FIFO. The details are shown in Figure 12-6 with the corresponding registers listed in Table 12-2.  $D'_n$  consists of 16 high-order bits of  $D_n$  and 16 zeros.  $D''_n$  consists of 16 low-order bits of  $D_n$  and 16 zeros. That is to say,  $D'_n = \{D_n[31 : 16], 16'h0\}$ ,  $D''_n = \{D_n[15 : 0], 16'h0\}$ .

At the second stage, the system reads data that will be sent from FIFO, according to the relevant register configuration. The mode in which the system reads data from FIFO is relevant to the configuration of I2S\_TX\_FIFO\_MOD[2:0] and I2S\_TX\_CHAN\_MOD[2:0]. I2S\_TX\_FIFO\_MOD[2:0] determines whether the data are 16-bit or 32-bit, as shown in Table 12-2, while I2S\_TX\_CHAN\_MOD[2:0] determines the format of the data-to-be-sent, as shown in Table 12-3.

Table 12-3. Send Channel Mode

I2S_TX_CHAN_MOD[2:0]	Description
0	Dual channel mode
1	Mono mode When I2S_TX_MSB_RIGHT equals 0, the left-channel data are "holding" their values and the right-channel data change into the left-channel data.

I2S_TX_CHAN_MOD[2:0]	Description
	When I2S_TX_MSB_RIGHT equals 1, the right-channel data are "holding" their values and the left-channel data change into the right-channel data.
2	Mono mode When I2S_TX_MSB_RIGHT equals 0, the right-channel data are "holding" their values and the left-channel data change into the right-channel data. When I2S_TX_MSB_RIGHT equals 1, the left-channel data are "holding" their values and the right-channel data change into the left-channel data.
3	Mono mode When I2S_TX_MSB_RIGHT equals 0, the left-channel data are constants in the range of REG[31:0]. When I2S_TX_MSB_RIGHT equals 1, the right-channel data are constants in the range of REG[31:0].
4	Mono mode When I2S_TX_MSB_RIGHT equals 0, the right-channel data are constants in the range of REG[31:0]. When I2S_TX_MSB_RIGHT equals 1, the left-channel data are constants in the range of REG[31:0].

REG[31:0] is the value of register I2S\_CONF\_SINGLE\_DATA\_REG[31:0].

The output of the third stage is determined by the mode of the I2S and I2S\_TX\_BITS\_MOD[5:0] bits of register I2S\_SAMPLE\_RATE\_CONF\_REG.

### 12.4.5 Receiving Data

The data-receive phase of the ESP32 I2S module consists of another three stages:

- The input serial-bit stream is transformed into a 64-bit parallel-data stream in I2S mode. In LCD mode, the input parallel-data stream will be extended to a 64-bit parallel-data stream.
- Received data are written into FIFO.
- Data are read from FIFO by CPU/DMA and written into the internal memory.

At the first stage of receiving data, the received-data stream is expanded to a zero-padded parallel-data stream with 32 high-order bits and 32 low-order bits, according to the level of the I2S<sub>n</sub>\_WS\_out (or I2S<sub>n</sub>\_WS\_in) signal. The I2S\_RX\_MSB\_RIGHT bit of register I2S\_CONF\_REG is used to determine how the data are to be expanded.

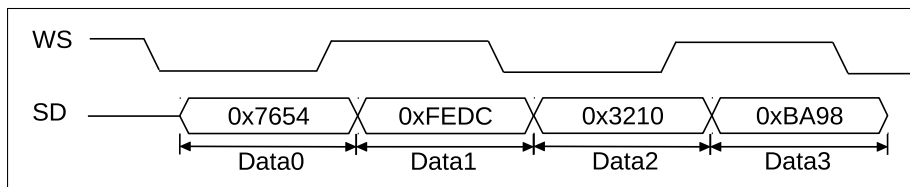


Figure 12-7. The First Stage of Receiving Data

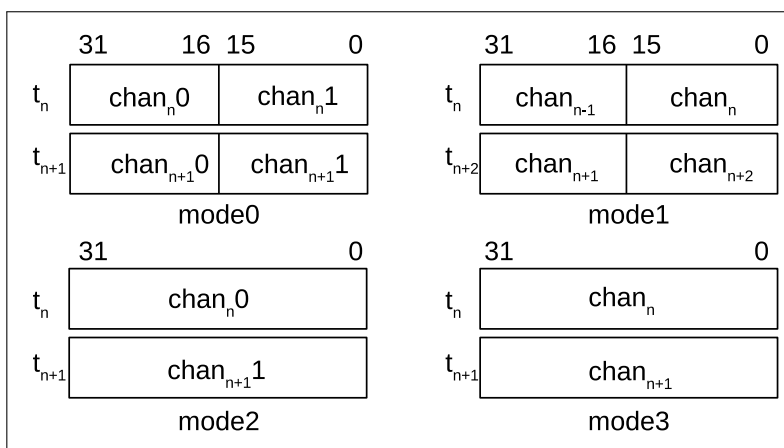
For example, as is shown in Figure 12-7, if the width of serial data is 16 bits, when I2S\_RX\_RIGHT\_FIRST equals 1, Data0 will be discarded and I2S will start receiving data from Data1. If I2S\_RX\_MSB\_RIGHT equals 1, data of the first stage would be {0xFEDC0000, 0x32100000}. If I2S\_RX\_MSB\_RIGHT equals 0, data of the first

stage would be  $\{0x32100000, 0xFEDC0000\}$ . When I2S\_RX\_RIGHT\_FIRST equals 0, I2S will start receiving data from Data0. If I2S\_RX\_MSB\_RIGHT equals 1, data of the first stage would be  $\{0xFEDC0000, 0x76540000\}$ . If I2S\_RX\_MSB\_RIGHT equals 0, data of the first stage would be  $\{0x76540000, 0xFEDC0000\}$ .

As is shown in Table 12-4 and Figure 12-8, at the second stage, the received data of the Rx unit is written into FIFO. There are four modes of writing received data into FIFO. Each mode corresponds to a value of I2S\_RX\_FIFO\_MOD[2:0] bit.

**Table 12-4. Modes of Writing Received Data into FIFO and the Corresponding Register Configuration**

I2S_RX_FIFO_MOD[2:0]	Data format
0	16-bit dual channel data
1	16-bit single channel data
2	32-bit dual channel data
3	32-bit single channel data



**Figure 12-8. Modes of Writing Received Data into FIFO**

At the third stage, CPU or DMA will read data from FIFO and write them into the internal memory directly. The register configuration that each mode corresponds to is shown in Table 12-5.

**Table 12-5. The Register Configuration to Which the Four Modes Correspond**

I2S_RX_MSB_RIGHT	I2S_RX_CHAN_MOD	mode0	mode1	mode2	mode3
0	0	left channel + right channel	-	left channel + right channel	-
	1		left channel + left channel		left channel + left channel
	2		right channel + right channel		right channel + right channel
	3		-		-
1	0	right channel + left channel	-	right channel + left channel	-
	1		right channel + right channel		right channel + right channel
	2		left channel + left channel		left channel + left channel
	3		-		-

### 12.4.6 I2S Master/Slave Mode

The ESP32 I2S module can be configured to act as a master or slave device on the I2S bus. The module supports slave transmitter and receiver configurations in addition to master transmitter and receiver configurations. All these modes can support full-duplex and half-duplex communication over the I2S bus.

I2S\_RX\_SLAVE\_MOD bit and I2S\_TX\_SLAVE\_MOD bit of register I2S\_CONF\_REG can configure I2S to slave receiving mode and slave transmitting mode, respectively.

I2S\_TX\_START bit of register I2S\_CONF\_REG is used to enable transmission. When I2S is in master transmitting mode and this bit is set, the module will keep driving the clock signal and data of left and right channels. If FIFO sends out all the buffered data and there are no new data to shift, the last batch of data will be looped on the data line. When this bit is reset, master will stop driving clock and data lines. When I2S is configured to slave transmitting mode and this bit is set, the module will wait for the master BCK clock to enable a transmit operation.

The I2S\_RX\_START bit of register I2S\_CONF\_REG is used to enable a receive operation. When I2S is in master receiving mode and this bit is set, the module will keep driving the clock signal and sampling the input data stream until this bit is reset. If I2S is configured to slave receiving mode and this bit is set, the receiving module will wait for the master BCK clock to enable a receiving operation.

### 12.4.7 I2S PDM

As is shown in Figure 12-1, ESP32 I2S0 allows for pulse density modulation (PDM), which enables fast conversion between pulse code modulation (PCM) and PDM signals.

The output clock of PDM is mapped to the I2S0\*\_WS\_out signal. Its configuration is identical to I2S's BCK. Please refer to section 12.3, "The Clock of I2S Module", for further details. The bit width for both received and transmitted I2S PCM signals is 16 bits.

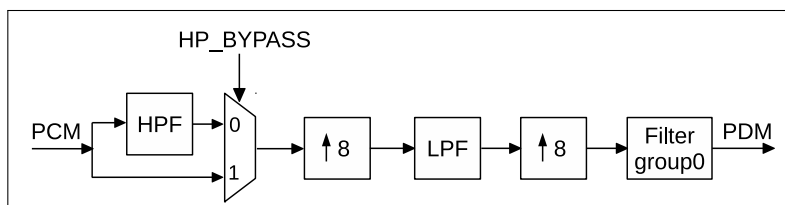


Figure 12-9. PDM Transmitting Module

The PDM transmitting module is used to convert PCM signals into PDM signals, as shown in Figure 12-9. HPF is a high-speed channel filter, and LPF is a low-speed channel filter. The PDM signal is derived from the PCM signal, after upsampling and filtering. Signal I2S\_TX\_PDM\_HP\_BYPASS of register I2S\_PDM\_CONF\_REG can be set to bypass the HPF at the PCM input. Filter module group0 carries out the upsampling. If the frequency of the PDM signal is  $f_{pdm}$  and the frequency of the PCM signal is  $f_{pcm}$ , the relation between  $f_{pdm}$  and  $f_{pcm}$  is given by:

$$f_{pdm} = 64 \times f_{pcm} \times \frac{I2S\_TX\_PDM\_FP}{I2S\_TX\_PDM\_FS}$$

The upsampling factor of 64 is the result of the two upsampling stages.

Table 12-6 lists the configuration rates of the I2S\_TX\_PDM\_FP bit and the I2S\_TX\_PDM\_FS bit of register I2S\_PDM\_FREQ\_CONF\_REG, whose output PDM signal frequency remains 48×128 KHz at different PCM signal frequencies.

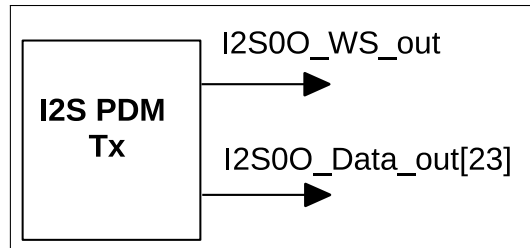
**Table 12-6. Upsampling Rate Configuration**

$f_{pcm}$ (KHz)	I2S_TX_PDM_FP	I2S_TX_PDM_FS	$f_{pdm}$ (KHz)
48	960	480	48×128
44.1	960	441	
32	960	320	
24	960	240	
16	960	160	
8	960	80	

The I2S\_TX\_PDM\_SINC\_OSR2 bit of I2S\_PDM\_CONF\_REG is the upsampling rate of the Filter group0.

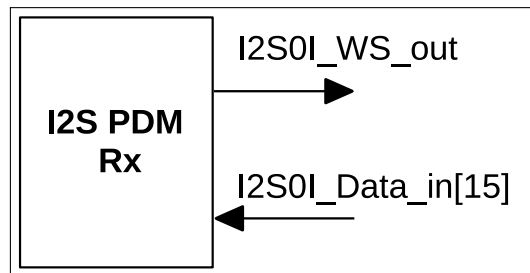
$$I2S\_TX\_PDM\_SINC\_OSR2 = \left\lfloor \frac{I2S\_TX\_PDM\_FP}{I2S\_TX\_PDM\_FS} \right\rfloor$$

As is shown in Figure 12-10, the I2S\_TX\_PDM\_EN bit and the I2S\_PCM2PDM\_CONV\_EN bit of register I2S\_PDM\_CONF\_REG should be set to 1 to use the PDM sending module. The I2S\_TX\_PDM\_SIGMADELTA\_IN\_SHIFT bit, I2S\_TX\_PDM\_SINC\_IN\_SHIFT bit, I2S\_TX\_PDM\_LP\_IN\_SHIFT bit and I2S\_TX\_PDM\_HP\_IN\_SHIFT bit of register I2S\_PDM\_CONF\_REG are used to adjust the size of the input signal of each filter module.

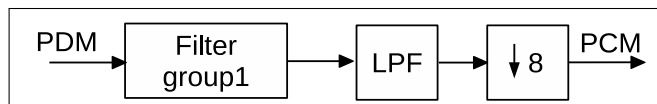


**Figure 12-10. PDM Sends Signal**

As is shown in Figure 12-11, the I2S\_RX\_PDM\_EN bit and the I2S\_PDM2PCM\_CONV\_EN bit of register I2S\_PDM\_CONF\_REG should be set to 1, in order to use the PDM receiving module. As is shown in Figure 12-12, the PDM receiving module will convert the received PDM signal into a 16-bit PCM signal. Filter group1 is used to downsample the PDM signal, and the I2S\_RX\_PDM\_SINC\_DSR\_16\_EN bit of register I2S\_PDM\_CONF\_REG is used to adjust the corresponding down-sampling rate.



**Figure 12-11. PDM Receives Signal**



**Figure 12-12. PDM Receive Module**

Table 12-7 shows the configuration of the I2S\_RX\_PDM\_SINC\_DSR\_16\_EN bit whose PCM signal frequency remains 48 KHz at different PDM signal frequencies.

**Table 12-7. Down-sampling Configuration**

PDM freq (KHz)	I2S_RX_PDM_SINC_DSR_16_EN	PCM freq (KHz)
$f_{\text{pcm}} \times 128$	1	$f_{\text{pcm}}$
$f_{\text{pcm}} \times 64$	0	

## 12.5 Camera-LCD Controller

There are three operational modes in the LCD mode of ESP32 I2S:

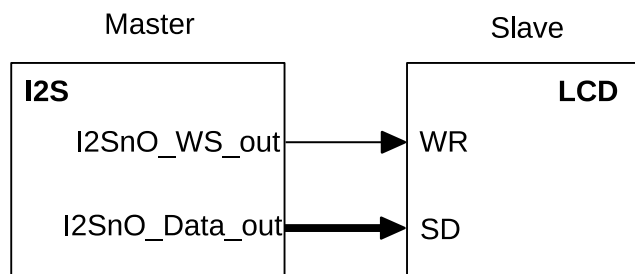
- LCD master transmitting mode
- Camera slave receiving mode
- ADC/DAC mode

The clock configuration of the LCD master transmitting mode is identical to I2S' clock configuration. In the LCD mode, the frequency of WS is half of  $f_{\text{BCK}}$ .

In the ADC/DAC mode, use PLL\_D2\_CLK as the clock source.

### 12.5.1 LCD Master Transmitting Mode

As is shown in Figure 12-13, the WR signal of LCD connects to the WS signal of I2S. The LCD data bus width is 24 bits.



**Figure 12-13. LCD Master Transmitting Mode**

The I2S\_LCD\_EN bit of register I2S\_CONF2\_REG needs to be set and the I2S\_TX\_SLAVE\_MOD bit of register I2S\_CONF\_REG needs to be cleared, in order to configure I2S to the LCD master transmitting mode. Meanwhile, data should be sent under the correct mode, according to the I2S\_TX\_CHAN\_MOD[2:0] bit of register I2S\_CONF\_CHAN\_REG and the I2S\_TX\_FIFO\_MOD[2:0] bit of register I2S\_FIFO\_CONF\_REG. The WS signal needs to be inverted when it is routed through the GPIO Matrix. For details, please refer to the chapter about [IO\\_MUX and the GPIO Matrix](#). The I2S\_LCD\_TX\_SDX2\_EN bit and the I2S\_LCD\_TX\_WRX2\_EN bit of register I2S\_CONF2\_REG should be set to the LCD master transmitting mode, so that both the data bus and WR signal work in the appropriate mode.



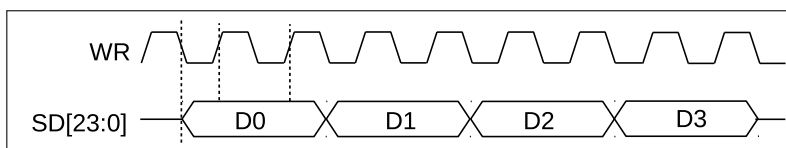


Figure 12-14. LCD Master Transmitting Data Frame, Form 1

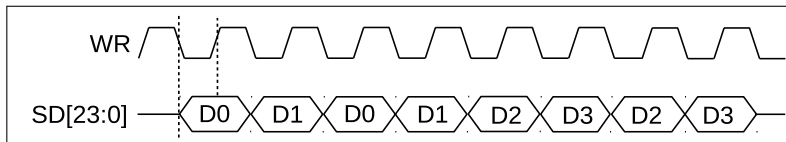


Figure 12-15. LCD Master Transmitting Data Frame, Form 2

As is shown in Figure 12-14 and Figure 12-15, the `I2S_LCD_TX_WRX2_EN` bit should be set to 1 and the `I2S_LCD_TX_SDX2_EN` bit should be set to 0 in the data frame, form 1. Both `I2S_LCD_TX_SDX2_EN` bit and `I2S_LCD_TX_WRX2_EN` bit are set to 1 in the data frame, form 2.

### 12.5.2 Camera Slave Receiving Mode

ESP32 I2S supports a camera slave mode for high-speed data transfer from external camera modules. As shown in Figure 12-16, in this mode, I2S is set to slave receiving mode. Besides the 16-channel data signal bus `I2SnI_Data_in`, there are other signals, such as `I2SnH_SYNC`, `I2SnV_SYNC` and `I2SnH_ENABLE`.

The PCLK in the Camera module connects to `I2SnI_WS_in` in the I2S module, as Figure 12-16 shows.

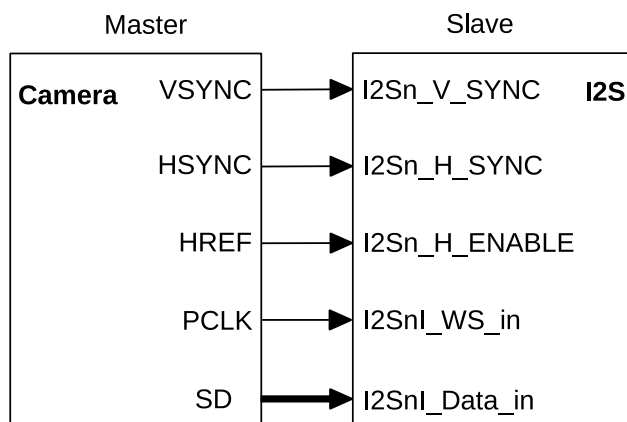


Figure 12-16. Camera Slave Receiving Mode

When I2S is in the camera slave receiving mode, and when `I2SnH_SYNC`, `I2SnV_SYNC` and `I2SnH_REF` are held high, the master starts transmitting data, that is,

$$transmission\_start = (I2SnH\_SYNC == 1) \&\& (I2SnV\_SYNC == 1) \&\& (I2SnH\_ENABLE == 1)$$

Thus, during data transmission, these three signals should be kept at a high level. For example, if the `I2SnV_SYNC` signal of a camera is at low level during data transmission, it will be inverted when routed to the I2S module. ESP32 supports signal inversion through the GPIO matrix. For details, please refer to the chapter about [IO\\_MUX and the GPIO Matrix](#).

In order to make I2S work in camera mode, the `I2S_LCD_EN` bit and the `I2S_CAMERA_EN` bit of register `I2S_CONF2_REG` are set to 1, the `I2S_RX_SLAVE_MOD` bit of register `I2S_CONF_REG` is set to 1, the `I2S_RX_MSB_RIGHT`

bit and the I2S\_RX\_RIGHT\_FIRST bit of I2S\_CONF\_REG are set to 0. Thus, I2S works in the LCD slave receiving mode. At the same time, in order to use the correct mode to receive data, both the I2S\_RX\_CHAN\_MOD[2:0] bit of register I2S\_CONF\_CHAN\_REG and the I2S\_RX\_FIFO\_MOD[2:0] bit of register I2S\_FIFO\_CONF\_REG are set to 1.

### 12.5.3 ADC/DAC mode

In LCD mode, ESP32's ADC and DAC can receive data. When the I2S0 module connects to the on-chip ADC, the I2S0 module should be set to master receiving mode. Figure 12-17 shows the signal connection between the I2S0 module and the ADC.

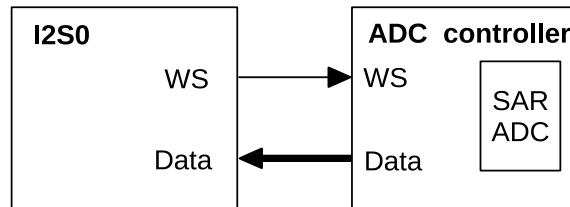


Figure 12-17. ADC Interface of I2S0

Firstly, the I2S\_LCD\_EN bit of register I2S\_CONF2\_REG is set to 1, and the I2S\_RX\_SLAVE\_MOD bit of register I2S\_CONF\_REG is set to 0, so that the I2S0 module works in LCD master receiving mode, and the I2S0 module clock is configured such that the WS signal of I2S0 outputs an appropriate frequency. Then, the APB\_CTRL\_SAR\_ADC\_DATA\_TO\_I2S bit of register APB\_CTRL\_APB\_SARADC\_CTRL\_REG is set to 1. Enable I2S to receive data after configuring the relevant registers of SARADC. For details, please refer to Chapter [On-Chip Sensors and Analog Signal Processing](#).

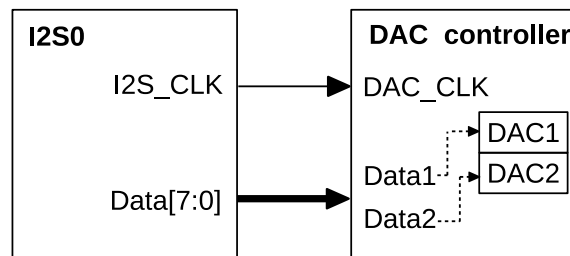


Figure 12-18. DAC Interface of I2S

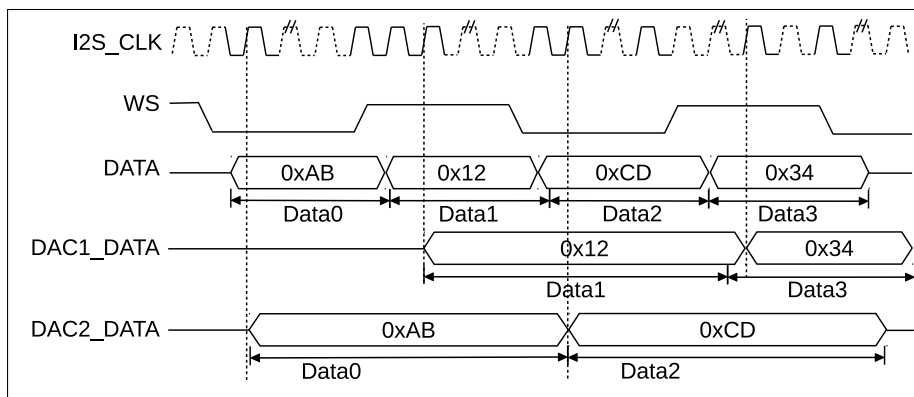


Figure 12-19. Data Input by I2S DAC Interface

The I2S0 module should be configured to master transmitting mode when it connects to the on-chip DAC. Figure

12-18 shows the signal connection between the I2S0 module and the DAC. The DAC's control module regards I2S\_CLK as the clock in this configuration. As shown in Figure 12-19, when the data bus inputs data to the DAC's control module, the latter will input right-channel data to DAC1 module and left-channel data to DAC2 module. When using the I2S DMA module, 8 bits of data-to-be-transmitted are shifted to the left by 8 bits of data-to-be-received into the DMA double-byte type of buffer.

The I2S\_LCD\_EN bit of register I2S\_CONF2\_REG should be set to 1, while I2S\_RX\_SHORT\_SYNC, I2S\_TX\_SHORT\_SYNC, I2S\_CONF\_REG, I2S\_RX\_MSB\_SHIFT and I2S\_TX\_MSB\_SHIFT should all be reset to 0. The I2S\_TX\_SLAVE\_MOD bit of register I2S\_CONF\_REG should be set to 0, as well, when using the DAC mode of I2S0. Select a suitable transmit mode according to the standards of transmitting a 16-bit digital data stream. Configure the I2S0 module clock to output a suitable frequency for the I2S\_CLK and the WS of I2S. Enable I2S0 to send data after configuring the relevant DAC registers.

## 12.6 I2S Interrupts

### 12.6.1 FIFO Interrupts

- I2S\_TX\_HUNG\_INT: Triggered when transmitting data is timed out.
- I2S\_RX\_HUNG\_INT: Triggered when receiving data is timed out.
- I2S\_TX\_EMPTY\_INT: Triggered when the transmit FIFO is empty.
- I2S\_TX\_WFULL\_INT: Triggered when the transmit FIFO is full.
- I2S\_RX\_EMPTY\_INT: Triggered when the receive FIFO is empty.
- I2S\_RX\_WFULL\_INT: Triggered when the receive FIFO is full.
- I2S\_TX\_PUT\_DATA\_INT: Triggered when the transmit FIFO is almost empty.
- I2S\_RX\_TAKE\_DATA\_INT: Triggered when the receive FIFO is almost full.

### 12.6.2 DMA Interrupts

- I2S\_OUT\_TOTAL\_EOF\_INT: Triggered when all transmitting linked lists are used up.
- I2S\_IN\_DSCR\_EMPTY\_INT: Triggered when there are no valid receiving linked lists left.
- I2S\_OUT\_DSCR\_ERR\_INT: Triggered when invalid rxlink descriptors are encountered.
- I2S\_IN\_DSCR\_ERR\_INT: Triggered when invalid txlink descriptors are encountered.
- I2S\_OUT\_EOF\_INT: Triggered when rxlink has finished sending a packet.
- I2S\_OUT\_DONE\_INT: Triggered when all transmitted and buffered data have been read.
- I2S\_IN\_SUC\_EOF\_INT: Triggered when all data have been received.
- I2S\_IN\_DONE\_INT: Triggered when the current txlink descriptor is handled.

## 12.7 Register Summary

Name	Description	I2S0	I2S1	Acc
<b>I2S FIFO registers</b>				
I2S_FIFO_WR_REG	Writes the data sent by I2S into FIFO	0x3FF4F000	0x3FF6D000	WO

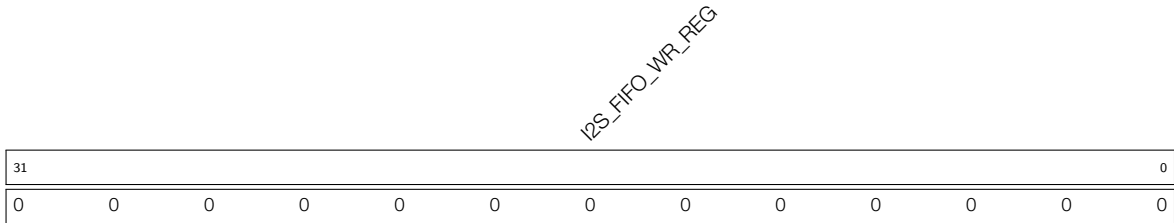
I2S_FIFO_RD_REG	Stores the data that I2S receives from FIFO	0x3FF4F004	0x3FF6D004	RO
<b>Configuration registers</b>				
I2S_CONF_REG	Configuration and start/stop bits	0x3FF4F008	0x3FF6D008	R/W
I2S_CONF1_REG	PCM configuration register	0x3FF4F0A0	0x3FF6D0A0	R/W
I2S_CONF2_REG	ADC/LCD/camera configuration register	0x3FF4F0A8	0x3FF6D0A8	R/W
I2S_TIMING_REG	Signal delay and timing parameters	0x3FF4F01C	0x3FF6D01C	R/W
I2S_FIFO_CONF_REG	FIFO configuration	0x3FF4F020	0x3FF6D020	R/W
I2S_CONF_SINGLE_DATA_REG	Static channel output value	0x3FF4F028	0x3FF6D028	R/W
I2S_CONF_CHAN_REG	Channel configuration	0x3FF4F02C	0x3FF6D02C	R/W
I2S_LC_HUNG_CONF_REG	Timeout detection configuration	0x3FF4F074	0x3FF6D074	R/W
I2S_CLKM_CONF_REG	Bitclock configuration	0x3FF4F0AC	0x3FF6D0AC	R/W
I2S_SAMPLE_RATE_CONF_REG	Sample rate configuration	0x3FF4F0B0	0x3FF6D0B0	R/W
I2S_PD_CONF_REG	Power-down register	0x3FF4F0A4	0x3FF6D0A4	R/W
I2S_STATE_REG	I2S status register	0x3FF4F0BC	0x3FF6D0BC	RO
<b>DMA registers</b>				
I2S_LC_CONF_REG	DMA configuration register	0x3FF4F060	0x3FF6D060	R/W
I2S_RXEOF_NUM_REG	Receive data count	0x3FF4F024	0x3FF6D024	R/W
I2S_OUT_LINK_REG	DMA transmit linked list configuration and address	0x3FF4F030	0x3FF6D030	R/W
I2S_IN_LINK_REG	DMA receive linked list configuration and address	0x3FF4F034	0x3FF6D034	R/W
I2S_OUT_EOF_DES_ADDR_REG	The address of transmit link descriptor producing EOF	0x3FF4F038	0x3FF6D038	RO
I2S_IN_EOF_DES_ADDR_REG	The address of receive link descriptor producing EOF	0x3FF4F03C	0x3FF6D03C	RO
I2S_OUT_EOF_BFR_DES_ADDR_REG	The address of transmit buffer producing EOF	0x3FF4F040	0x3FF6D040	RO
I2S_INLINK_DSCR_REG	The address of current inlink descriptor	0x3FF4F048	0x3FF6D048	RO
I2S_INLINK_DSCR_BF0_REG	The address of next inlink descriptor	0x3FF4F04C	0x3FF6D04C	RO
I2S_INLINK_DSCR_BF1_REG	The address of next inlink data buffer	0x3FF4F050	0x3FF6D050	RO
I2S_OUTLINK_DSCR_REG	The address of current outlink descriptor	0x3FF4F054	0x3FF6D054	RO
I2S_OUTLINK_DSCR_BF0_REG	The address of next outlink descriptor	0x3FF4F058	0x3FF6D058	RO
I2S_OUTLINK_DSCR_BF1_REG	The address of next outlink data buffer	0x3FF4F05C	0x3FF6D05C	RO
I2S_LC_STATE0_REG	DMA receive status	0x3FF4F06C	0x3FF6D06C	RO
I2S_LC_STATE1_REG	DMA transmit status	0x3FF4F070	0x3FF6D070	RO

<b>Pulse density (DE) modulation registers</b>				
<a href="#">I2S_PDM_CONF_REG</a>	PDM configuration	0x3FF4F0B4	0x3FF6D0B4	R/W
<a href="#">I2S_PDM_FREQ_CONF_REG</a>	PDM frequencies	0x3FF4F0B8	0x3FF6D0B8	R/W
<b>Interrupt registers</b>				
<a href="#">I2S_INT_RAW_REG</a>	Raw interrupt status	0x3FF4F00C	0x3FF6D00C	RO
<a href="#">I2S_INT_ST_REG</a>	Masked interrupt status	0x3FF4F010	0x3FF6D010	RO
<a href="#">I2S_INT_ENA_REG</a>	Interrupt enable bits	0x3FF4F014	0x3FF6D014	R/W
<a href="#">I2S_INT_CLR_REG</a>	Interrupt clear bits	0x3FF4F018	0x3FF6D018	WO

## 12.8 Registers

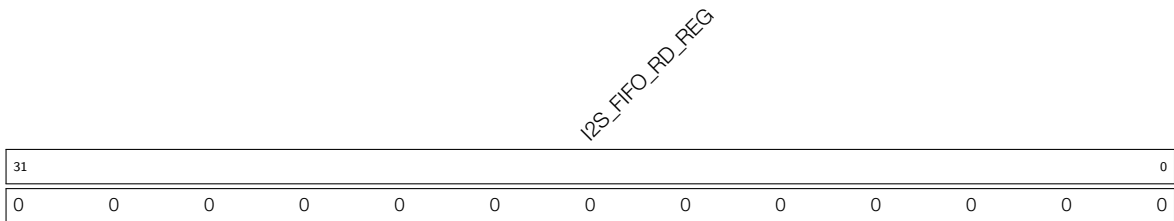
The addresses in parenthesis besides register names are the register addresses relative to the I2S0/I2S1 base addresses provided in Table 1-6 *Peripheral Address Mapping* in Chapter 1 *System and Memory*. The absolute register addresses are listed in Section 12.7 *Register Summary*.

### Register 12.1. I2S\_FIFO\_WR\_REG (0x0000)



**I2S\_FIFO\_WR\_REG** Writes the data sent by I2S into FIFO. (WO)

### Register 12.2. I2S\_FIFO\_RD\_REG (0x0004)



**I2S\_FIFO\_RD\_REG** Stores the data that I2S receives from FIFO. (RO)

**Register 12.3. I2S\_CONF\_REG (0x0008)**

(reserved)																			<i>I2S_SIG_LOOPBACK</i> <i>I2S_RX_MSB_RIGHT</i> <i>I2S_TX_MSB_RIGHT</i> <i>I2S_RX_MONO</i> <i>I2S_TX_MONO</i> <i>I2S_RX_SHORT_SYNC</i> <i>I2S_TX_SHORT_SYNC</i> <i>I2S_RX_MSB_SHIFT</i> <i>I2S_TX_MSB_SHIFT</i> <i>I2S_RX_RIGHT_FIRST</i> <i>I2S_TX_RIGHT_FIRST</i> <i>I2S_RX_SLAVE_MOD</i> <i>I2S_TX_SLAVE_MOD</i> <i>I2S_RX_START</i> <i>I2S_TX_START</i> <i>I2S_RX_FIFO_RESET</i> <i>I2S_TX_FIFO_RESET</i> <i>I2S_RX_RESET</i> <i>I2S_TX_RESET</i>																								
31																				19	18	17	16	15	14	13	12	11	10	9	8	7	6	5	4	3	2	1	0				
0	0	0	0	0	0	0	0	0	0	0	0	0	0	0	0	0	0	0	0	0	0	0	1	1	1	1	0	0	0	0	0	0	0	0	0	0	0	0	0	0	0	0	Reset

**I2S\_SIG\_LOOPBACK** Enable signal loopback mode, with transmitter module and receiver module sharing the same WS and BCK signals. (R/W)

**I2S\_RX\_MSB\_RIGHT** Set this to place right-channel data at the MSB in the receive FIFO. (R/W)

**I2S\_TX\_MSB\_RIGHT** Set this bit to place right-channel data at the MSB in the transmit FIFO. (R/W)

**I2S\_RX\_MONO** Set this bit to enable receiver's mono mode in PCM standard mode. (R/W)

**I2S\_TX\_MONO** Set this bit to enable transmitter's mono mode in PCM standard mode. (R/W)

**I2S\_RX\_SHORT\_SYNC** Set this bit to enable receiver in PCM standard mode. (R/W)

**I2S\_TX\_SHORT\_SYNC** Set this bit to enable transmitter in PCM standard mode. (R/W)

**I2S\_RX\_MSB\_SHIFT** Set this bit to enable receiver in Philips standard mode. (R/W)

**I2S\_TX\_MSB\_SHIFT** Set this bit to enable transmitter in Philips standard mode. (R/W)

**I2S\_RX\_RIGHT\_FIRST** Set this bit to receive right-channel data first. (R/W)

**I2S\_TX\_RIGHT\_FIRST** Set this bit to transmit right-channel data first. (R/W)

**I2S\_RX\_SLAVE\_MOD** Set this bit to enable slave receiver mode. (R/W)

**I2S\_TX\_SLAVE\_MOD** Set this bit to enable slave transmitter mode. (R/W)

**I2S\_RX\_START** Set this bit to start receiving data. (R/W)

**I2S\_TX\_START** Set this bit to start transmitting data. (R/W)

**I2S\_RX\_FIFO\_RESET** Set this bit to reset the receive FIFO. (R/W)

**I2S\_TX\_FIFO\_RESET** Set this bit to reset the transmit FIFO. (R/W)

**I2S\_RX\_RESET** Set this bit to reset the receiver. (R/W)

**I2S\_TX\_RESET** Set this bit to reset the transmitter. (R/W)

## Register 12.4. I2S\_INT\_RAW\_REG (0x000c)

31														17	16	15	14	13	12	11	10	9	8	7	6	5	4	3	2	1	0	Reset
0	0	0	0	0	0	0	0	0	0	0	0	0	0	0	0	0	0	0	0	0	0	0	0	0	0	0	0	0	0	0	0	0

(reserved)

I2S\_OUT\_TOTAL\_EOF\_INT\_RAW  
I2S\_IN\_DSCR\_EMPTY\_INT\_RAW  
I2S\_OUT\_DSCR\_ERR\_INT\_RAW  
I2S\_IN\_DSCR\_ERR\_INT\_RAW  
I2S\_OUT\_EOF\_INT\_RAW  
I2S\_OUT\_DONE\_INT\_RAW  
I2S\_IN\_SUC\_EOF\_INT\_RAW  
I2S\_IN\_DONE\_INT\_RAW  
I2S\_TX\_HUNG\_INT\_RAW  
I2S\_RX\_HUNG\_INT\_RAW  
I2S\_TX\_EMPTY\_INT\_RAW  
I2S\_RX\_WFULL\_INT\_RAW  
I2S\_TX\_REMPTY\_INT\_RAW  
I2S\_RX\_REMPTY\_INT\_RAW  
I2S\_TX\_PUT\_DATA\_INT\_RAW  
I2S\_RX\_TAKE\_DATA\_INT\_RAW

**I2S\_OUT\_TOTAL\_EOF\_INT\_RAW** The raw interrupt status bit for the [I2S\\_OUT\\_TOTAL\\_EOF\\_INT](#) interrupt. (RO)

**I2S\_IN\_DSCR\_EMPTY\_INT\_RAW** The raw interrupt status bit for the [I2S\\_IN\\_DSCR\\_EMPTY\\_INT](#) interrupt. (RO)

**I2S\_OUT\_DSCR\_ERR\_INT\_RAW** The raw interrupt status bit for the [I2S\\_OUT\\_DSCR\\_ERR\\_INT](#) interrupt. (RO)

**I2S\_IN\_DSCR\_ERR\_INT\_RAW** The raw interrupt status bit for the [I2S\\_IN\\_DSCR\\_ERR\\_INT](#) interrupt. (RO)

**I2S\_OUT\_EOF\_INT\_RAW** The raw interrupt status bit for the [I2S\\_OUT\\_EOF\\_INT](#) interrupt. (RO)

**I2S\_OUT\_DONE\_INT\_RAW** The raw interrupt status bit for the [I2S\\_OUT\\_DONE\\_INT](#) interrupt. (RO)

**I2S\_IN\_SUC\_EOF\_INT\_RAW** The raw interrupt status bit for the [I2S\\_IN\\_SUC\\_EOF\\_INT](#) interrupt. (RO)

**I2S\_IN\_DONE\_INT\_RAW** The raw interrupt status bit for the [I2S\\_IN\\_DONE\\_INT](#) interrupt. (RO)

**I2S\_TX\_HUNG\_INT\_RAW** The raw interrupt status bit for the [I2S\\_TX\\_HUNG\\_INT](#) interrupt. (RO)

**I2S\_RX\_HUNG\_INT\_RAW** The raw interrupt status bit for the [I2S\\_RX\\_HUNG\\_INT](#) interrupt. (RO)

**I2S\_TX\_REMPTY\_INT\_RAW** The raw interrupt status bit for the [I2S\\_TX\\_REMPTY\\_INT](#) interrupt. (RO)

**I2S\_TX\_WFULL\_INT\_RAW** The raw interrupt status bit for the [I2S\\_TX\\_WFULL\\_INT](#) interrupt. (RO)

**I2S\_RX\_REMPTY\_INT\_RAW** The raw interrupt status bit for the [I2S\\_RX\\_REMPTY\\_INT](#) interrupt. (RO)

**I2S\_RX\_WFULL\_INT\_RAW** The raw interrupt status bit for the [I2S\\_RX\\_WFULL\\_INT](#) interrupt. (RO)

**I2S\_TX\_PUT\_DATA\_INT\_RAW** The raw interrupt status bit for the [I2S\\_TX\\_PUT\\_DATA\\_INT](#) interrupt. (RO)

**I2S\_RX\_TAKE\_DATA\_INT\_RAW** The raw interrupt status bit for the [I2S\\_RX\\_TAKE\\_DATA\\_INT](#) interrupt. (RO)



**Register 12.5. I2S\_INT\_ST\_REG (0x0010)**

(reserved)																	I2S_OUT_TOTAL_EOF_INT_ST	I2S_IN_DSCR_EMPTY_INT_ST	I2S_OUT_DSCR_ERR_INT_ST	I2S_IN_DSCR_ERR_INT_ST	I2S_OUT_EOF_INT_ST	(reserved)	I2S_IN_DONE_INT_ST	I2S_IN_SUC_EOF_INT_ST	I2S_TX_DONE_INT_ST	I2S_TX_HUNG_INT_ST	I2S_RX_HUNG_INT_ST	I2S_TX_REMPTY_INT_ST	I2S_RX_WFULL_INT_ST	I2S_RX_REMPTY_INT_ST	I2S_TX_PUT_DATA_INT_ST	I2S_RX_TAKE_DATA_INT_ST		
31																17	16	15	14	13	12	11	10	9	8	7	6	5	4	3	2	1	0	Reset
0																																		

**I2S\_OUT\_TOTAL\_EOF\_INT\_ST** The masked interrupt status bit for the **I2S\_OUT\_TOTAL\_EOF\_INT** interrupt. (RO)

**I2S\_IN\_DSCR\_EMPTY\_INT\_ST** The masked interrupt status bit for the **I2S\_IN\_DSCR\_EMPTY\_INT** interrupt. (RO)

**I2S\_OUT\_DSCR\_ERR\_INT\_ST** The masked interrupt status bit for the **I2S\_OUT\_DSCR\_ERR\_INT** interrupt. (RO)

**I2S\_IN\_DSCR\_ERR\_INT\_ST** The masked interrupt status bit for the **I2S\_IN\_DSCR\_ERR\_INT** interrupt. (RO)

**I2S\_OUT\_EOF\_INT\_ST** The masked interrupt status bit for the **I2S\_OUT\_EOF\_INT** interrupt. (RO)

**I2S\_OUT\_DONE\_INT\_ST** The masked interrupt status bit for the **I2S\_OUT\_DONE\_INT** interrupt. (RO)

**I2S\_IN\_SUC\_EOF\_INT\_ST** The masked interrupt status bit for the **I2S\_IN\_SUC\_EOF\_INT** interrupt. (RO)

**I2S\_IN\_DONE\_INT\_ST** The masked interrupt status bit for the **I2S\_IN\_DONE\_INT** interrupt. (RO)

**I2S\_TX\_HUNG\_INT\_ST** The masked interrupt status bit for the **I2S\_TX\_HUNG\_INT** interrupt. (RO)

**I2S\_RX\_HUNG\_INT\_ST** The masked interrupt status bit for the **I2S\_RX\_HUNG\_INT** interrupt. (RO)

**I2S\_TX\_REMPTY\_INT\_ST** The masked interrupt status bit for the **I2S\_TX\_REMPTY\_INT** interrupt. (RO)

**I2S\_TX\_WFULL\_INT\_ST** The masked interrupt status bit for the **I2S\_TX\_WFULL\_INT** interrupt. (RO)

**I2S\_RX\_REMPTY\_INT\_ST** The masked interrupt status bit for the **I2S\_RX\_REMPTY\_INT** interrupt. (RO)

**I2S\_RX\_WFULL\_INT\_ST** The masked interrupt status bit for the **I2S\_RX\_WFULL\_INT** interrupt. (RO)

**I2S\_TX\_PUT\_DATA\_INT\_ST** The masked interrupt status bit for the **I2S\_TX\_PUT\_DATA\_INT** interrupt. (RO)

**I2S\_RX\_TAKE\_DATA\_INT\_ST** The masked interrupt status bit for the **I2S\_RX\_TAKE\_DATA\_INT** interrupt. (RO)

## Register 12.6. I2S\_INT\_ENA\_REG (0x0014)

(reserved)																	<i>I2S_OUT_TOTAL_EOF_INT_ENA</i> <i>I2S_IN_DSCR_EMPTY_INT_ENA</i> <i>I2S_OUT_DSCR_ERR_INT_ENA</i> <i>I2S_IN_DSCR_ERR_INT_ENA</i> <i>I2S_OUT_EOF_INT_ENA</i> <i>I2S_OUT_DONE_INT_ENA</i> <i>(reserved)</i> <i>I2S_IN_SUC_EOF_INT_ENA</i> <i>I2S_IN_DONE_INT_ENA</i> <i>I2S_TX_HUNG_INT_ENA</i> <i>I2S_RX_HUNG_INT_ENA</i> <i>I2S_TX_REMPTY_INT_ENA</i> <i>I2S_RX_REMPTY_INT_ENA</i> <i>I2S_TX_WFULL_INT_ENA</i> <i>I2S_RX_WFULL_INT_ENA</i> <i>I2S_TX_PUT_DATA_INT_ENA</i> <i>I2S_RX_TAKE_DATA_INT_ENA</i>																		
31																	17	16	15	14	13	12	11	10	9	8	7	6	5	4	3	2	1	0	Reset
0																	0																		

**I2S\_OUT\_TOTAL\_EOF\_INT\_ENA** The interrupt enable bit for the [I2S\\_OUT\\_TOTAL\\_EOF\\_INT](#) interrupt. (R/W)

**I2S\_IN\_DSCR\_EMPTY\_INT\_ENA** The interrupt enable bit for the [I2S\\_IN\\_DSCR\\_EMPTY\\_INT](#) interrupt. (R/W)

**I2S\_OUT\_DSCR\_ERR\_INT\_ENA** The interrupt enable bit for the [I2S\\_OUT\\_DSCR\\_ERR\\_INT](#) interrupt. (R/W)

**I2S\_IN\_DSCR\_ERR\_INT\_ENA** The interrupt enable bit for the [I2S\\_IN\\_DSCR\\_ERR\\_INT](#) interrupt. (R/W)

**I2S\_OUT\_EOF\_INT\_ENA** The interrupt enable bit for the [I2S\\_OUT\\_EOF\\_INT](#) interrupt. (R/W)

**I2S\_OUT\_DONE\_INT\_ENA** The interrupt enable bit for the [I2S\\_OUT\\_DONE\\_INT](#) interrupt. (R/W)

**I2S\_IN\_SUC\_EOF\_INT\_ENA** The interrupt enable bit for the [I2S\\_IN\\_SUC\\_EOF\\_INT](#) interrupt. (R/W)

**I2S\_IN\_DONE\_INT\_ENA** The interrupt enable bit for the [I2S\\_IN\\_DONE\\_INT](#) interrupt. (R/W)

**I2S\_TX\_HUNG\_INT\_ENA** The interrupt enable bit for the [I2S\\_TX\\_HUNG\\_INT](#) interrupt. (R/W)

**I2S\_RX\_HUNG\_INT\_ENA** The interrupt enable bit for the [I2S\\_RX\\_HUNG\\_INT](#) interrupt. (R/W)

**I2S\_TX\_REMPTY\_INT\_ENA** The interrupt enable bit for the [I2S\\_TX\\_REMPTY\\_INT](#) interrupt. (R/W)

**I2S\_TX\_WFULL\_INT\_ENA** The interrupt enable bit for the [I2S\\_TX\\_WFULL\\_INT](#) interrupt. (R/W)

**I2S\_RX\_REMPTY\_INT\_ENA** The interrupt enable bit for the [I2S\\_RX\\_REMPTY\\_INT](#) interrupt. (R/W)

**I2S\_RX\_WFULL\_INT\_ENA** The interrupt enable bit for the [I2S\\_RX\\_WFULL\\_INT](#) interrupt. (R/W)

**I2S\_TX\_PUT\_DATA\_INT\_ENA** The interrupt enable bit for the [I2S\\_TX\\_PUT\\_DATA\\_INT](#) interrupt. (R/W)

**I2S\_RX\_TAKE\_DATA\_INT\_ENA** The interrupt enable bit for the [I2S\\_RX\\_TAKE\\_DATA\\_INT](#) interrupt. (R/W)

**Register 12.7. I2S\_INT\_CLR\_REG (0x0018)**

(reserved)																	<i>I2S_OUT_TOTAL_EOF_INT_CLR</i> <i>I2S_IN_DSCR_EMPTY_INT_CLR</i> <i>I2S_OUT_DSCR_ERR_INT_CLR</i> <i>I2S_IN_DSCR_ERR_INT_CLR</i> <i>I2S_OUT_EOF_INT_CLR</i> <i>I2S_OUT_DONE_INT_CLR</i> <i>I2S_IN_SUC_EOF_INT_CLR</i> <i>I2S_IN_DONE_INT_CLR</i> <i>I2S_TX_HUNG_INT_CLR</i> <i>I2S_RX_HUNG_INT_CLR</i> <i>I2S_TX_EMPTY_INT_CLR</i> <i>I2S_RX_WFULL_INT_CLR</i> <i>I2S_TX_REMPTY_INT_CLR</i> <i>I2S_RX_WFULL_INT_CLR</i> <i>I2S_TX_PUT_DATA_INT_CLR</i> <i>I2S_RX_TAKE_DATA_INT_CLR</i>																		
31																	17	16	15	14	13	12	11	10	9	8	7	6	5	4	3	2	1	0	Reset
0																	0																		

- I2S\_OUT\_TOTAL\_EOF\_INT\_CLR** Set this bit to clear the `I2S_OUT_TOTAL_EOF_INT` interrupt. (WO)
- I2S\_IN\_DSCR\_EMPTY\_INT\_CLR** Set this bit to clear the `I2S_IN_DSCR_EMPTY_INT` interrupt. (WO)
- I2S\_OUT\_DSCR\_ERR\_INT\_CLR** Set this bit to clear the `I2S_OUT_DSCR_ERR_INT` interrupt. (WO)
- I2S\_IN\_DSCR\_ERR\_INT\_CLR** Set this bit to clear the `I2S_IN_DSCR_ERR_INT` interrupt. (WO)
- I2S\_OUT\_EOF\_INT\_CLR** Set this bit to clear the `I2S_OUT_EOF_INT` interrupt. (WO)
- I2S\_OUT\_DONE\_INT\_CLR** Set this bit to clear the `I2S_OUT_DONE_INT` interrupt. (WO)
- I2S\_IN\_SUC\_EOF\_INT\_CLR** Set this bit to clear the `I2S_IN_SUC_EOF_INT` interrupt. (WO)
- I2S\_IN\_DONE\_INT\_CLR** Set this bit to clear the `I2S_IN_DONE_INT` interrupt. (WO)
- I2S\_TX\_HUNG\_INT\_CLR** Set this bit to clear the `I2S_TX_HUNG_INT` interrupt. (WO)
- I2S\_RX\_HUNG\_INT\_CLR** Set this bit to clear the `I2S_RX_HUNG_INT` interrupt. (WO)
- I2S\_TX\_REMPTY\_INT\_CLR** Set this bit to clear the `I2S_TX_REMPTY_INT` interrupt. (WO)
- I2S\_TX\_WFULL\_INT\_CLR** Set this bit to clear the `I2S_TX_WFULL_INT` interrupt. (WO)
- I2S\_RX\_REMPTY\_INT\_CLR** Set this bit to clear the `I2S_RX_REMPTY_INT` interrupt. (WO)
- I2S\_RX\_WFULL\_INT\_CLR** Set this bit to clear the `I2S_RX_WFULL_INT` interrupt. (WO)
- I2S\_TX\_PUT\_DATA\_INT\_CLR** Set this bit to clear the `I2S_TX_PUT_DATA_INT` interrupt. (WO)
- I2S\_RX\_TAKE\_DATA\_INT\_CLR** Set this bit to clear the `I2S_RX_TAKE_DATA_INT` interrupt. (WO)

## Register 12.8. I2S\_TIMING\_REG (0x001c)

31	25	24	23	22	21	20	19	18	17	16	15	14	13	12	11	10	9	8	7	6	5	4	3	2	1	0	
0	0	0	0	0	0	0	0	0	0	0	0	0	0	0	0	0	0	0	0	0	0	0	0	0	0	0	0

Reset

**I2S\_TX\_BCK\_IN\_INV** Set this bit to invert the BCK signal into the slave transmitter. (R/W)

**I2S\_DATA\_ENABLE\_DELAY** Number of delay cycles for data valid flag. (R/W)

**I2S\_RX\_DSSYNC\_SW** Set this bit to synchronize signals into the receiver in double sync method. (R/W)

**I2S\_TX\_DSSYNC\_SW** Set this bit to synchronize signals into the transmitter in double sync method. (R/W)

**I2S\_RX\_BCK\_OUT\_DELAY** Number of delay cycles for BCK signal out of the receiver. (R/W)

**I2S\_RX\_WS\_OUT\_DELAY** Number of delay cycles for WS signal out of the receiver. (R/W)

**I2S\_TX\_SD\_OUT\_DELAY** Number of delay cycles for SD signal out of the transmitter. (R/W)

**I2S\_TX\_WS\_OUT\_DELAY** Number of delay cycles for WS signal out of the transmitter. (R/W)

**I2S\_TX\_BCK\_OUT\_DELAY** Number of delay cycles for BCK signal out of the transmitter. (R/W)

**I2S\_RX\_SD\_IN\_DELAY** Number of delay cycles for SD signal into the receiver. (R/W)

**I2S\_RX\_WS\_IN\_DELAY** Number of delay cycles for WS signal into the receiver. (R/W)

**I2S\_RX\_BCK\_IN\_DELAY** Number of delay cycles for BCK signal into the receiver. (R/W)

**I2S\_TX\_WS\_IN\_DELAY** Number of delay cycles for WS signal into the transmitter. (R/W)

**I2S\_TX\_BCK\_IN\_DELAY** Number of delay cycles for BCK signal into the transmitter. (R/W)

**Register 12.9. I2S\_FIFO\_CONF\_REG (0x0020)**

(reserved)										I2S_RX_FIFO_MOD_FORCE_EN				I2S_TX_FIFO_MOD_FORCE_EN				I2S_RX_FIFO_MOD				I2S_TX_FIFO_MOD				I2S_DSCR_EN				I2S_TX_DATA_NUM				I2S_RX_DATA_NUM			
31											21	20	19	18	16	15	13	12	11					6	5					0							
0 0 0 0 0 0 0 0 0 0										0 0 0 0 0				0 0 0 0				1				32				32				Reset							

**I2S\_RX\_FIFO\_MOD\_FORCE\_EN** The bit should always be set to 1. (R/W)

**I2S\_TX\_FIFO\_MOD\_FORCE\_EN** The bit should always be set to 1. (R/W)

**I2S\_RX\_FIFO\_MOD** Receive FIFO mode configuration bit. (R/W)

**I2S\_TX\_FIFO\_MOD** Transmit FIFO mode configuration bit. (R/W)

**I2S\_DSCR\_EN** Set this bit to enable I2S DMA mode. (R/W)

**I2S\_TX\_DATA\_NUM** Threshold of data length in the transmit FIFO. (R/W)

**I2S\_RX\_DATA\_NUM** Threshold of data length in the receive FIFO. (R/W)

**Register 12.10. I2S\_RXEOF\_NUM\_REG (0x0024)**

31																																																															0	
64																																																																Reset

**I2S\_RXEOF\_NUM\_REG** The length of the data to be received. It will trigger [I2S\\_IN\\_SUC\\_EOF\\_INT](#). (R/W)

**Register 12.11. I2S\_CONF\_SINGLE\_DATA\_REG (0x0028)**

31																																																															0	
0																																																																Reset

**I2S\_CONF\_SINGLE\_DATA\_REG** The right channel or the left channel outputs constant values stored in this register according to [TX\\_CHAN\\_MOD](#) and [I2S\\_TX\\_MSB\\_RIGHT](#). (R/W)

**Register 12.12. I2S\_CONF\_CHAN\_REG (0x002c)**

(reserved)																	<i>I2S_RX_CHAN_MOD</i>		<i>I2S_TX_CHAN_MOD</i>				
31																		5	4	3	2	0	Reset
0	0	0	0	0	0	0	0	0	0	0	0	0	0	0	0	0	0	0	0	0	0	0	

**I2S\_RX\_CHAN\_MOD** I2S receiver channel mode configuration bits. Please refer to Section 12.4.5 for further details. (R/W)

**I2S\_TX\_CHAN\_MOD** I2S transmitter channel mode configuration bits. Please refer to Section 12.4.4 for further details. (R/W)

**Register 12.13. I2S\_OUT\_LINK\_REG (0x0030)**

<i>(reserved)</i>						<i>I2S_OUTLINK_RESTART</i>					<i>(reserved)</i>					<i>I2S_OUTLINK_ADDR</i>																				
31	30	29	28	27										20	19																				0	Reset
0	0	0	0	0	0	0	0	0	0	0	0	0	0	0x000000																						

**I2S\_OUTLINK\_RESTART** Set this bit to restart outlink descriptor. (R/W)

**I2S\_OUTLINK\_START** Set this bit to start outlink descriptor. (R/W)

**I2S\_OUTLINK\_STOP** Set this bit to stop outlink descriptor. (R/W)

**I2S\_OUTLINK\_ADDR** The address of first outlink descriptor. (R/W)

**Register 12.14. I2S\_IN\_LINK\_REG (0x0034)**

<i>(reserved)</i>						<i>I2S_INLINK_RESTART</i>					<i>(reserved)</i>					<i>I2S_INLINK_ADDR</i>																			
31	30	29	28	27										20	19																			0	Reset
0	0	0	0	0	0	0	0	0	0	0	0	0	0	0x000000																					

**I2S\_INLINK\_RESTART** Set this bit to restart inlink descriptor. (R/W)

**I2S\_INLINK\_START** Set this bit to start inlink descriptor. (R/W)

**I2S\_INLINK\_STOP** Set this bit to stop inlink descriptor. (R/W)

**I2S\_INLINK\_ADDR** The address of first inlink descriptor. (R/W)

**Register 12.15. I2S\_OUT\_EOF\_DES\_ADDR\_REG (0x0038)**

31	0
0x00000000	

Reset

**I2S\_OUT\_EOF\_DES\_ADDR\_REG** The address of outlink descriptor that produces EOF. (RO)

**Register 12.16. I2S\_IN\_EOF\_DES\_ADDR\_REG (0x003c)**

31	0
0x00000000	

Reset

**I2S\_IN\_EOF\_DES\_ADDR\_REG** The address of inlink descriptor that produces EOF. (RO)

**Register 12.17. I2S\_OUT\_EOF\_BFR\_DES\_ADDR\_REG (0x0040)**

31	0
0x00000000	

Reset

**I2S\_OUT\_EOF\_BFR\_DES\_ADDR\_REG** The address of the buffer corresponding to the outlink descriptor that produces EOF. (RO)

**Register 12.18. I2S\_INLINK\_DSCR\_REG (0x0048)**

31	0
0 0	

Reset

**I2S\_INLINK\_DSCR\_REG** The address of current inlink descriptor. (RO)

**Register 12.19. I2S\_INLINK\_DSCR\_BF0\_REG (0x004c)**

31	0
0 0	

Reset

**I2S\_INLINK\_DSCR\_BF0\_REG** The address of next inlink descriptor. (RO)

**Register 12.20. I2S\_INLINK\_DSCR\_BF1\_REG (0x0050)**

31	0
0 0	

Reset

**I2S\_INLINK\_DSCR\_BF1\_REG** The address of next inlink data buffer. (RO)

**Register 12.21. I2S\_OUTLINK\_DSCR\_REG (0x0054)**

31	0
0 0	

Reset

**I2S\_OUTLINK\_DSCR\_REG** The address of current outlink descriptor. (RO)

**Register 12.22. I2S\_OUTLINK\_DSCR\_BF0\_REG (0x0058)**

31	0
0 0	

Reset

**I2S\_OUTLINK\_DSCR\_BF0\_REG** The address of next outlink descriptor. (RO)

**Register 12.23. I2S\_OUTLINK\_DSCR\_BF1\_REG (0x005c)**

31	0
0 0	

Reset

**I2S\_OUTLINK\_DSCR\_BF1\_REG** The address of next outlink data buffer. (RO)



**Register 12.24. I2S\_LC\_CONF\_REG (0x0060)**

31	(reserved)													13	12	11	10	9	8	7	6	5	4	3	2	1	0	Reset
0	0	0	0	0	0	0	0	0	0	0	0	0	0	0	0	0	0	0	0	0	0	0	0	0	0	0	0	

**I2S\_CHECK\_OWNER** Set this bit to check the owner bit by hardware. (R/W)

**I2S\_OUT\_DATA\_BURST\_EN** Transmitter data transfer mode configuration bit. (R/W)

- 1: Transmit data in burst mode;
- 0: Transmit data in byte mode.

**I2S\_INDSCR\_BURST\_EN** DMA inlink descriptor transfer mode configuration bit. (R/W)

- 1: Transfer inlink descriptor in burst mode;
- 0: Transfer inlink descriptor in byte mode.

**I2S\_OUTDSCR\_BURST\_EN** DMA outlink descriptor transfer mode configuration bit. (R/W)

- 1: Transfer outlink descriptor in burst mode;
- 0: Transfer outlink descriptor in byte mode.

**I2S\_OUT\_EOF\_MODE** DMA [I2S\\_OUT\\_EOF\\_INT](#) generation mode. (R/W)

- 1: When DMA has popped all data from the FIFO;
- 0: When AHB has pushed all data to the FIFO.

**I2S\_OUT\_AUTO\_WBACK** Set this bit to enable automatic outlink-writeback when all the data in tx buffer has been transmitted. (R/W)

**I2S\_OUT\_LOOP\_TEST** Set this bit to loop test outlink. (R/W)

**I2S\_IN\_LOOP\_TEST** Set this bit to loop test inlink. (R/W)

**I2S\_AHBM\_RST** Set this bit to reset AHB interface of DMA. (R/W)

**I2S\_AHBM\_FIFO\_RST** Set this bit to reset AHB interface cmdFIFO of DMA. (R/W)

**I2S\_OUT\_RST** Set this bit to reset out DMA FSM. (R/W)

**I2S\_IN\_RST** Set this bit to reset in DMA FSM. (R/W)

**Register 12.25. I2S\_LC\_STATE0\_REG (0x006c)**

31																																0	
0x00000000																																	Reset

**I2S\_LC\_STATE0\_REG** Receiver DMA channel status register. (RO)

**Register 12.26. I2S\_LC\_STATE1\_REG (0x0070)**

31	0
0x00000000	
Reset	

**I2S\_LC\_STATE1\_REG** Transmitter DMA channel status register. (RO)

**Register 12.27. I2S\_LC\_HUNG\_CONF\_REG (0x0074)**

(reserved)												<i>I2S_LC_FIFO_TIMEOUT_ENA</i>			<i>I2S_LC_FIFO_TIMEOUT_SHIFT</i>			<i>I2S_LC_FIFO_TIMEOUT</i>				
31											12	11	10			8	7				0	
0 0 0 0 0 0 0 0 0 0 0 0												1	0	0	0	0x010						Reset

**I2S\_LC\_FIFO\_TIMEOUT\_ENA** The enable bit for FIFO timeout. (R/W)

**I2S\_LC\_FIFO\_TIMEOUT\_SHIFT** The bits are used to set the tick counter threshold. The tick counter is reset when the counter value  $\geq 88000/2^{i2s\_lc\_fifo\_timeout\_shift}$ . (R/W)

**I2S\_LC\_FIFO\_TIMEOUT** When the value of FIFO hung counter is equal to this bit value, sending data-timeout interrupt or receiving data-timeout interrupt will be triggered. (R/W)

**Register 12.28. I2S\_CONF1\_REG (0x00a0)**

(reserved)																I2S_TX_STOP_EN	I2S_RX_PCM_BYPASS	I2S_RX_PCM_CONF	I2S_TX_PCM_BYPASS	I2S_TX_PCM_CONF			
31																9	8	7	6	4	3	2	0
0																0	1	0x0		1	0x1		Reset

**I2S\_TX\_STOP\_EN** Set this bit and the transmitter will stop transmitting BCK signal and WS signal when tx FIFO is empty. (R/W)

**I2S\_RX\_PCM\_BYPASS** Set this bit to bypass the Compress/Decompress module for the received data. (R/W)

**I2S\_RX\_PCM\_CONF** Compress/Decompress module configuration bit. (R/W)  
 0: Decompress received data;  
 1: Compress received data.

**I2S\_TX\_PCM\_BYPASS** Set this bit to bypass the Compress/Decompress module for the transmitted data. (R/W)

**I2S\_TX\_PCM\_CONF** Compress/Decompress module configuration bit. (R/W)  
 0: Decompress transmitted data;  
 1: Compress transmitted data.

**Register 12.29. I2S\_PD\_CONF\_REG (0x00a4)**

(reserved)																(reserved)	(reserved)	I2S_FIFO_FORCE_PU	I2S_FIFO_FORCE_PD	
31																4	3	2	1	0
0																1	0	1	0	Reset

**I2S\_FIFO\_FORCE\_PU** Force FIFO power-up. (R/W)

**I2S\_FIFO\_FORCE\_PD** Force FIFO power-down. (R/W)



**Register 12.32. I2S\_SAMPLE\_RATE\_CONF\_REG (0x00b0)**

(reserved)								I2S_RX_BITS_MOD						I2S_TX_BITS_MOD						I2S_RX_BCK_DIV_NUM						I2S_TX_BCK_DIV_NUM																		
31								24				23					18				17					12				11					6				5					0
0								0								0								0								0												
								16								16								6						6														
																																								Reset				

**I2S\_RX\_BITS\_MOD** Set the bits to configure the bit length of I2S receiver channel. (R/W)

**I2S\_TX\_BITS\_MOD** Set the bits to configure the bit length of I2S transmitter channel. (R/W)

**I2S\_RX\_BCK\_DIV\_NUM** Bit clock configuration bit in receiver mode. (R/W)

**I2S\_TX\_BCK\_DIV\_NUM** Bit clock configuration bit in transmitter mode. (R/W)



## Register 12.35. I2S\_STATE\_REG (0x00bc)

(reserved)															I2S_RX_FIFO_RESET_BACK			I2S_TX_FIFO_RESET_BACK			I2S_TX_IDLE			
31															3	2	1	0						
0	0	0	0	0	0	0	0	0	0	0	0	0	0	0	0	0	0	0	1	Reset				

**I2S\_RX\_FIFO\_RESET\_BACK** This bit is used to confirm if the Rx FIFO reset is done. 1: reset is not ready; 0: reset is ready. (RO)

**I2S\_TX\_FIFO\_RESET\_BACK** This bit is used to confirm if the Tx FIFO reset is done. 1: reset is not ready; 0: reset is ready. (RO)

**I2S\_TX\_IDLE** The status bit of the transmitter. 1: the transmitter is idle; 0: the transmitter is busy. (RO)

## 13 UART Controller (UART)

### 13.1 Overview

Embedded applications often require a simple method of exchanging data between devices that need minimal system resources. The Universal Asynchronous Receiver/Transmitter (UART) is one such standard that can realize a flexible full-duplex data exchange among different devices. The three UART controllers available on a chip are compatible with UART-enabled devices from various manufacturers. The UART can also carry out an IrDA (Infrared Data Exchange), or function as an RS-485 modem.

All UART controllers integrated in the ESP32 feature an identical set of registers for ease of programming and flexibility. In this documentation, these controllers are referred to as UART $n$ , where  $n = 0, 1, \text{ and } 2$ , referring to UART0, UART1, and UART2, respectively.

### 13.2 UART Features

The UART modules have the following main features:

- Programmable baud rate
- 1024 × 8-bit RAM shared by three UART transmit-FIFOs and receive-FIFOs
- Supports input baud rate self-check
- Supports 5/6/7/8 bits of data length
- Supports 1/1.5/2/3 STOP bits
- Supports parity bit
- Supports RS485 Protocol
- Supports IrDA Protocol
- Supports DMA to communicate data in high speed
- Supports UART wake-up
- Supports both software and hardware flow control

### 13.3 Functional Description

#### 13.3.1 Introduction

UART is a character-oriented data link that can be used to achieve communication between two devices. The asynchronous mode of transmission means that it is not necessary to add clocking information to the data being sent. This, in turn, requires that the data rate, STOP bits, parity, etc., be identical at the transmitting and receiving end for the devices to communicate successfully.

A typical UART frame begins with a START bit, followed by a “character” and an optional parity bit for error detection, and it ends with a STOP condition. The UART controllers available on the ESP32 provide hardware support for multiple lengths of data and STOP bits. In addition, the controllers support both software and hardware flow control, as well as DMA, for seamless high-speed data transfer. This allows the developer to employ multiple UART ports in the system with minimal software overhead.



### 13.3.2 UART Architecture

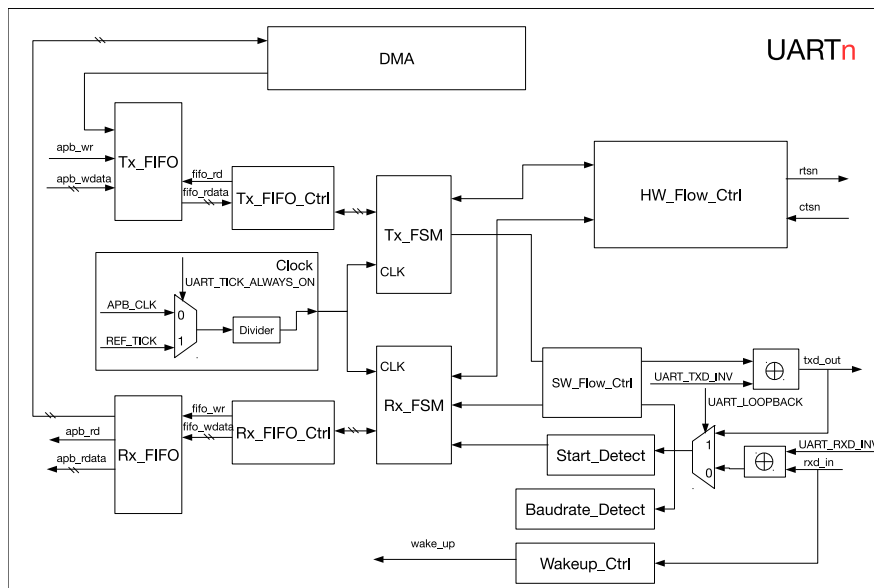


Figure 13-1. UART Basic Structure

Figure 13-1 shows the basic block diagram of the UART controller. The UART block can derive its clock from two sources: the 80-MHz APB\_CLK, or the reference clock REF\_TICK (please refer to Chapter [Reset and Clock](#) for more details). These two clock sources can be selected by configuring UART\_TICK\_REF\_ALWAYS\_ON.

Then, a divider in the clock path divides the selected clock source to generate clock signals that drive the UART module. UART\_CLKDIV\_REG contains the clock divider value in two parts — UART\_CLKDIV (integral part) and UART\_CLKDIV\_FRAG (decimal part).

The UART controller can be further broken down into two functional blocks — the transmit block and the receive block.

The transmit block contains a transmit-FIFO buffer, which buffers data awaiting to be transmitted. Software can write Tx\_FIFO via APB, and transmit data into Tx\_FIFO via DMA. Tx\_FIFO\_Ctrl is used to control read- and write-access to the Tx\_FIFO. When Tx\_FIFO is not null, Tx\_FSM reads data via Tx\_FIFO\_Ctrl, and transmits data out according to the set frame format. The outgoing bit stream can be inverted by appropriately configuring the register UART\_TXD\_INV.

The receive-block contains a receive-FIFO buffer, which buffers incoming data awaiting to be processed. The input bit stream, rxd\_in, is fed to the UART controller. Negation of the input stream can be controlled by configuring the UART\_RXD\_INV register. Baudrate\_Detect measures the baud rate of the input signal by measuring the minimum pulse width of the input bit stream. Start\_Detect is used to detect a START bit in a frame of incoming data. After detecting the START bit, Rx\_FSM stores data retrieved from the received frame into Rx\_FIFO through Rx\_FIFO\_Ctrl.

Software can read data in the Rx\_FIFO through the APB. In order to free the CPU from engaging in data transfer operations, the DMA can be configured for sending or receiving data.

HW\_Flow\_Ctrl is able to control the data flow of rxd\_in and txd\_out through standard UART RTS and CTS flow control signals (rtsn\_out and ctsn\_in). SW\_Flow\_Ctrl controls the data flow by inserting special characters in the incoming and outgoing data flow. When UART is in Light-sleep mode (refer to Chapter [Low-Power Management](#)), Wakeup\_Ctrl will start counting pulses in rxd\_in. When the number or positive edges of Rx\_D signal is greater than

or equal to (`UART_ACTIVE_THRESHOLD+2`), a `wake_up` signal will be generated and sent to RTC. RTC will then wake up the UART controller. **Note** that only UART1 and UART2 support Light-sleep mode and that `rxd_in` cannot be input through GPIO Matrix but only through IO\_MUX.

### 13.3.3 UART RAM

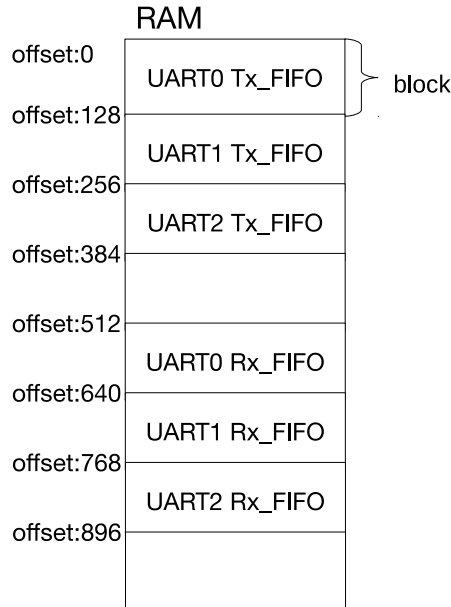


Figure 13-2. UART Shared RAM

Three UART controllers share a  $1024 \times 8$ -bit RAM space. As illustrated in Figure 13-2, RAM is allocated in different blocks. One block holds  $128 \times 8$ -bit data. Figure 13-2 illustrates the default RAM allocated to Tx\_FIFO and Rx\_FIFO of the three UART controllers. Tx\_FIFO of UART $n$  can be extended by setting `UART $n$ _TX_SIZE`, while Rx\_FIFO of UART $n$  can be extended by setting `UART $n$ _RX_SIZE`.

**NOTICE:** Extending the FIFO space of a UART controller may take up the FIFO space of another UART controller.

If none of the UART controllers is active, setting `UART_MEM_PD`, `UART1_MEM_PD`, and `UART2_MEM_PD` can prompt the RAM to enter low-power mode.

In UART0, bit `UART_TXFIFO_RST` and bit `UART_RXFIFO_RST` can be set to reset Tx\_FIFO or Rx\_FIFO, respectively. In UART1, bit `UART1_TXFIFO_RST` and bit `UART1_RXFIFO_RST` can be set to reset Tx\_FIFO or Rx\_FIFO, respectively.

**Note:**

UART2 doesn't have any register to reset Tx\_FIFO or Rx\_FIFO, and the `UART1_TXFIFO_RST` and `UART1_RXFIFO_RST` in UART1 may impact the functioning of UART2. Therefore, these 2 registers in UART1 should only be used when the Tx\_FIFO and Rx\_FIFO in UART2 do not have any data.

UART $n$  can access FIFO via register `UART_FIFO_REG`.

### 13.3.4 Baud Rate Detection

Setting `UART_AUTOBAUD_EN` for a UART controller will enable the baud rate detection function. The `Baudrate_Detect` block shown in Figure 13-1 can filter glitches with a pulse width lower than `UART_GLITCH_FILT`.

In order to use the baud rate detection feature, some random data should be sent to the receiver before starting the UART communication stream. This is required so that the baud rate can be determined based on the pulse width. `UART_LOWPULSE_MIN_CNT` stores minimum low-pulse width, `UART_HIGHPULSE_MIN_CNT` stores minimum high-pulse width. By reading these two registers, software can calculate the baud rate of the transmitter.

### 13.3.5 UART Data Frame

Figure 13-3 shows the basic data frame structure. A data frame starts with a START condition and ends with a STOP condition. The START condition requires 1 bit and the STOP condition can be realized using 1/1.5/2/3-bit widths (as set by `UART_STOP_BIT_NUM`, `UART_DL1_EN`, and `UART_DL0_EN`). The START is low level, while the STOP is high level.

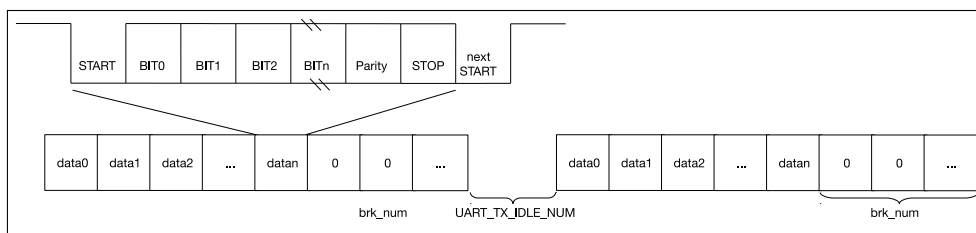


Figure 13-3. UART Data Frame Structure

The length of a character (BIT0 to BITn) can comprise 5 to 8 bits and can be configured by `UART_BIT_NUM`. When `UART_PARITY_EN` is set, the UART controller hardware will add the appropriate parity bit after the data. `UART_PARITY` is used to select odd parity or even parity. If the receiver detects an error in the input character, interrupt `UART_PARITY_ERR_INT` will be generated. If the receiver detects an error in the frame format, interrupt `UART_FRM_ERR_INT` will be generated.

Interrupt `UART_TX_DONE_INT` will be generated when all data in `Tx_FIFO` have been transmitted. When `UART_TXD_BRK` is set, the transmitter sends several NULL characters after the process of sending data is completed. The number of NULL characters can be configured by `UART_TX_BRK_NUM`. After the transmitter finishes sending all NULL characters, interrupt `UART_TX_BRK_DONE_INT` will be generated. The minimum interval between data frames can be configured with `UART_TX_IDLE_NUM`. If the idle time of a data frame is equal to, or larger than, the configured value of register `UART_TX_IDLE_NUM`, interrupt `UART_TX_BRK_IDLE_DONE_INT` will be generated.

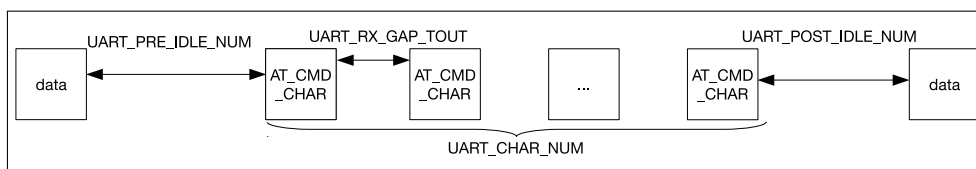


Figure 13-4. AT\_CMD Character Format

Figure 13-4 shows a special `AT_CMD` character format. If the receiver constantly receives `UART_AT_CMD_CHAR` characters and these characters satisfy the following conditions, interrupt `UART_AT_CMD_CHAR_DET_INT` will be generated.

- Between the first UART\_AT\_CMD\_CHAR and the last non-UART\_AT\_CMD\_CHAR, there are at least UART\_PER\_IDLE\_NUM APB clock cycles.
- Between every UART\_AT\_CMD\_CHAR character there must be less than UART\_RX\_GAP\_TOUT APB clock cycles.
- The number of received UART\_AT\_CMD\_CHAR characters must be equal to, or greater than, UART\_CHAR\_NUM.
- Between the last UART\_AT\_CMD\_CHAR character received and the next non-UART\_AT\_CMD\_CHAR, there are at least UART\_POST\_IDLE\_NUM APB clock cycles.

### 13.3.6 Flow Control

UART controller supports both hardware and software flow control. Hardware flow control regulates data flow through input signal `dsrn_in` and output signal `rtsn_out`. Software flow control regulates data flow by inserting special characters in the flow of sent data and by detecting special characters in the flow of received data.

#### 13.3.6.1 Hardware Flow Control

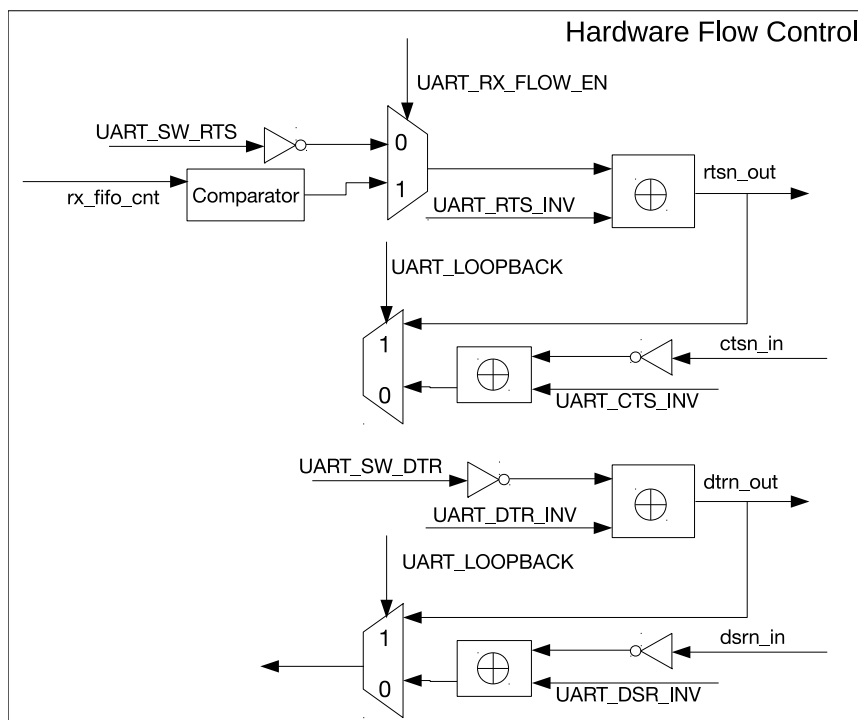


Figure 13-5. Hardware Flow Control

Figure 13-5 illustrates how the UART hardware flow control works. In hardware flow control, a high state of the output signal `rtsn_out` signifies that a data transmission is requested, while a low state of the same signal notifies the counterpart to stop data transmission until `rtsn_out` is pulled high again. There are two ways for a transmitter to realize hardware flow control:

- `UART_RX_FLOW_EN` is 0: The level of `rtsn_out` can be changed by configuring `UART_SW_RTS`.
- `UART_RX_FLOW_EN` is 1: If data in `Rx_FIFO` is greater than `UART_RX_FLOW_THRHD`, the level of `rtsn_out` will be lowered.

If the UART controller detects an edge on `ctsn_in`, it will generate interrupt `UART_CTS_CHG_INT` and will stop transmitting data, once the current data transmission is completed.

The high level of the output signal `dtrn_out` signifies that the transmitter has finished data preparation. UART controller will generate interrupt `UART_DSR_CHG_INT`, after it detects an edge on the input signal `dsrn_in`. After the software detects the above-mentioned interrupt, the input signal level of `dsrn_in` can be figured out by reading `UART_DSRN`. The software then decides whether it is able to receive data at that time or not.

Setting `UART_LOOPBACK` will enable the UART loopback detection function. In this mode, the output signal `txd_out` of UART is connected to its input signal `rxd_in`, `rtn_out` is connected to `ctsn_in`, and `dtrn_out` is connected to `dsrn_out`. If the data transmitted corresponds to the data received, UART is able to transmit and receive data normally.

### 13.3.6.2 Software Flow Control

Software can force the transmitter to stop transmitting data by setting `UART_FORCE_XOFF`, as well as force the transmitter to continue sending data by setting `UART_FORCE_XON`.

UART can also control the software flow by transmitting special characters. Setting `UART_SW_FLOW_CON_EN` will enable the software flow control function. If the number of data bytes that UART has received exceeds that of the `UART_XOFF` threshold, the UART controller can send `UART_XOFF_CHAR` to instruct its counterpart to stop data transmission.

When `UART_SW_FLOW_CON_EN` is 1, software can send flow control characters at any time. When `UART_SEND_XOFF` is set, the transmitter will insert a `UART_XOFF_CHAR` and send it after the current data transmission is completed. When `UART_SEND_XON` is set, the transmitter will insert a `UART_XON_CHAR` and send it after the current data transmission is completed.

### 13.3.7 UART DMA

For information on the UART DMA, please refer to Chapter [DMA Controller](#).

### 13.3.8 UART Interrupts

- `UART_AT_CMD_CHAR_DET_INT`: Triggered when the receiver detects the configured `at_cmd` char.
- `UART_RS485_CLASH_INT`: Triggered when a collision is detected between transmitter and receiver in RS-485 mode.
- `UART_RS485_FRM_ERR_INT`: Triggered when a data frame error is detected in RS-485.
- `UART_RS485_PARITY_ERR_INT`: Triggered when a parity error is detected in RS-485 mode.
- `UART_TX_DONE_INT`: Triggered when the transmitter has sent out all FIFO data.
- `UART_TX_BRK_IDLE_DONE_INT`: Triggered when the transmitter's idle state has been kept to a minimum after sending the last data.
- `UART_TX_BRK_DONE_INT`: Triggered when the transmitter completes sending NULL characters, after all data in transmit-FIFO are sent.
- `UART_GLITCH_DET_INT`: Triggered when the receiver detects a START bit.
- `UART_SW_XOFF_INT`: Triggered, if the receiver gets an Xon char when `UART_SW_FLOW_CON_EN` is set to 1.

- `UART_SW_XON_INT`: Triggered, if the receiver gets an Xoff char when `UART_SW_FLOW_CON_EN` is set to 1.
- `UART_RXFIFO_TOUT_INT`: Triggered when the receiver takes more time than `RX_TOUT_THRHD` to receive a byte.
- `UART_BRK_DET_INT`: Triggered when the receiver detects a 0 level after the STOP bit.
- `UART_CTS_CHG_INT`: Triggered when the receiver detects an edge change of the CTSn signal.
- `UART_DSR_CHG_INT`: Triggered when the receiver detects an edge change of the DSRn signal.
- `UART_RXFIFO_OVF_INT`: Triggered when the receiver gets more data than the FIFO can store.
- `UART_FRM_ERR_INT`: Triggered when the receiver detects a data frame error .
- `UART_PARITY_ERR_INT`: Triggered when the receiver detects a parity error in the data.
- `UART_TXFIFO_EMPTY_INT`: Triggered when the amount of data in the transmit-FIFO is less than what `tx_mem_cnttxfifo_cnt` specifies.
- `UART_RXFIFO_FULL_INT`: Triggered when the receiver gets more data than what (`rx_flow_thrhd_h3`, `rx_flow_thrhd`) specifies.

### 13.3.9 UHCI Interrupts

- `UHCI_SEND_A_REG_Q_INT`: When using the `always_send` registers to send a series of short packets, this is triggered when DMA has sent a short packet.
- `UHCI_SEND_S_REG_Q_INT`: When using the `single_send` registers to send a series of short packets, this is triggered when DMA has sent a short packet.
- `UHCI_OUT_TOTAL_EOF_INT`: Triggered when all data have been sent.
- `UHCI_OUTLINK_EOF_ERR_INT`: Triggered when there are some errors in EOF in the outlink descriptor.
- `UHCI_IN_DSCR_EMPTY_INT`: Triggered when there are not enough inlinks for DMA.
- `UHCI_OUT_DSCR_ERR_INT`: Triggered when there are some errors in the inlink descriptor.
- `UHCI_IN_DSCR_ERR_INT`: Triggered when there are some errors in the outlink descriptor.
- `UHCI_OUT_EOF_INT`: Triggered when the current descriptor's EOF bit is 1.
- `UHCI_OUT_DONE_INT`: Triggered when an outlink descriptor is completed.
- `UHCI_IN_ERR_EOF_INT`: Triggered when there are some errors in EOF in the inlink descriptor.
- `UHCI_IN_SUC_EOF_INT`: Triggered when a data packet has been received.
- `UHCI_IN_DONE_INT`: Triggered when an inlink descriptor has been completed.
- `UHCI_TX_HUNG_INT`: Triggered when DMA takes much time to read data from RAM.
- `UHCI_RX_HUNG_INT`: Triggered when DMA takes much time to receive data .
- `UHCI_TX_START_INT`: Triggered when DMA detects a separator char.
- `UHCI_RX_START_INT`: Triggered when a separator char has been sent.

## 13.4 Register Summary

### 13.4.1 UART Registers

Name	Description	UART0	UART1	UART2	Acc
<b>Configuration registers</b>					
UART_CONF0_REG	Configuration register 0	0x3FF40020	0x3FF50020	0x3FF6E020	R/W
UART_CONF1_REG	Configuration register 1	0x3FF40024	0x3FF50024	0x3FF6E024	R/W
UART_CLKDIV_REG	Clock divider configuration	0x3FF40014	0x3FF50014	0x3FF6E014	R/W
UART_FLOW_CONF_REG	Software flow-control configuration	0x3FF40034	0x3FF50034	0x3FF6E034	R/W
UART_SWFC_CONF_REG	Software flow-control character configuration	0x3FF4003C	0x3FF5003C	0x3FF6E03C	R/W
UART_SLEEP_CONF_REG	Sleep-mode configuration	0x3FF40038	0x3FF50038	0x3FF6E038	R/W
UART_IDLE_CONF_REG	Frame-end idle configuration	0x3FF40040	0x3FF50040	0x3FF6E040	R/W
UART_RS485_CONF_REG	RS485 mode configuration	0x3FF40044	0x3FF50044	0x3FF6E044	R/W
<b>Status registers</b>					
UART_STATUS_REG	UART status register	0x3FF4001C	0x3FF5001C	0x3FF6E01C	RO
<b>Autobaud registers</b>					
UART_AUTOBAUD_REG	Autobaud configuration register	0x3FF40018	0x3FF50018	0x3FF6E018	R/W
UART_LOWPULSE_REG	Autobaud minimum low pulse duration register	0x3FF40028	0x3FF50028	0x3FF6E028	RO
UART_HIGHPULSE_REG	Autobaud minimum high pulse duration register	0x3FF4002C	0x3FF5002C	0x3FF6E02C	RO
UART_POSPULSE_REG	Autobaud high pulse register	0x3FF40068	0x3FF50068	0x3FF6E068	RO
UART_NEGPULSE_REG	Autobaud low pulse register	0x3FF4006C	0x3FF5006C	0x3FF6E06C	RO
UART_RXD_CNT_REG	Autobaud edge change count register	0x3FF40030	0x3FF50030	0x3FF6E030	RO
<b>AT escape sequence detection configuration</b>					
UART_AT_CMD_PRECNT_REG	Pre-sequence timing configuration	0x3FF40048	0x3FF50048	0x3FF6E048	R/W
UART_AT_CMD_POSTCNT_REG	Post-sequence timing configuration	0x3FF4004C	0x3FF5004C	0x3FF6E04C	R/W
UART_AT_CMD_GAPTOUR_REG	Timeout configuration	0x3FF40050	0x3FF50050	0x3FF6E050	R/W
UART_AT_CMD_CHAR_REG	AT escape sequence detection configuration	0x3FF40054	0x3FF50054	0x3FF6E054	R/W
<b>FIFO configuration</b>					

UART_FIFO_REG	FIFO data register	0x3FF40000	0x3FF50000	0x3FF6E000	R/W
UART_MEM_CONF_REG	UART threshold and allocation configuration	0x3FF40058	0x3FF50058	0x3FF6E058	R/W
UART_MEM_CNT_STATUS_REG	Receive and transmit memory configuration	0x3FF40064	0x3FF50064	0x3FF6E064	RO
<b>Interrupt registers</b>					
UART_INT_RAW_REG	Raw interrupt status	0x3FF40004	0x3FF50004	0x3FF6E004	RO
UART_INT_ST_REG	Masked interrupt status	0x3FF40008	0x3FF50008	0x3FF6E008	RO
UART_INT_ENA_REG	Interrupt enable bits	0x3FF4000C	0x3FF5000C	0x3FF6E00C	R/W
UART_INT_CLR_REG	Interrupt clear bits	0x3FF40010	0x3FF50010	0x3FF6E010	WO

### 13.4.2 UHCI Registers

Name	Description	UDMA0	UDMA1	Acc
<b>Configuration registers</b>				
UHCI_CONF0_REG	UART and frame separation config	0x3FF54000	0x3FF4C000	R/W
UHCI_CONF1_REG	UHCI config register	0x3FF5402C	0x3FF4C02C	R/W
UHCI_ESCAPE_CONF_REG	Escape characters configuration	0x3FF54064	0x3FF4C064	R/W
UHCI_HUNG_CONF_REG	Timeout configuration	0x3FF54068	0x3FF4C068	R/W
UHCI_ESC_CONF0_REG	Escape sequence configuration register 0	0x3FF540B0	0x3FF4C0B0	R/W
UHCI_ESC_CONF1_REG	Escape sequence configuration register 1	0x3FF540B4	0x3FF4C0B4	R/W
UHCI_ESC_CONF2_REG	Escape sequence configuration register 2	0x3FF540B8	0x3FF4C0B8	R/W
UHCI_ESC_CONF3_REG	Escape sequence configuration register 3	0x3FF540BC	0x3FF4C0BC	R/W
<b>DMA configuration</b>				
UHCI_DMA_OUT_LINK_REG	Link descriptor address and control	0x3FF54024	0x3FF4C024	R/W
UHCI_DMA_IN_LINK_REG	Link descriptor address and control	0x3FF54028	0x3FF4C028	R/W
UHCI_DMA_OUT_PUSH_REG	FIFO data push register	0x3FF54018	0x3FF4C018	R/W
UHCI_DMA_IN_POP_REG	FIFO data pop register	0x3FF54020	0x3FF4C020	RO
<b>DMA status</b>				
UHCI_DMA_OUT_STATUS_REG	DMA FIFO status	0x3FF54014	0x3FF4C014	RO
UHCI_DMA_OUT_EOF_DES_ADDR_REG	Out EOF link descriptor address on success	0x3FF54038	0x3FF4C038	RO
UHCI_DMA_OUT_EOF_BFR_DES_ADDR_REG	Out EOF link descriptor address on error	0x3FF54044	0x3FF4C044	RO
UHCI_DMA_IN_SUC_EOF_DES_ADDR_REG	In EOF link descriptor address on success	0x3FF5403C	0x3FF4C03C	RO



UHCI_DMA_IN_ERR_EOF_DES_ADDR_REG	In EOF link descriptor address on error	0x3FF54040	0x3FF4C040	RO
UHCI_DMA_IN_DSCR_REG	Current inlink descriptor, first word	0x3FF5404C	0x3FF4C04C	RO
UHCI_DMA_IN_DSCR_BF0_REG	Current inlink descriptor, second word	0x3FF54050	0x3FF4C050	RO
UHCI_DMA_IN_DSCR_BF1_REG	Current inlink descriptor, third word	0x3FF54054	0x3FF4C054	RO
UHCI_DMA_OUT_DSCR_REG	Current outlink descriptor, first word	0x3FF54058	0x3FF4C058	RO
UHCI_DMA_OUT_DSCR_BF0_REG	Current outlink descriptor, second word	0x3FF5405C	0x3FF4C05C	RO
UHCI_DMA_OUT_DSCR_BF1_REG	Current outlink descriptor, third word	0x3FF54060	0x3FF4C060	RO
<b>Interrupt registers</b>				
UHCI_INT_RAW_REG	Raw interrupt status	0x3FF54004	0x3FF4C004	RO
UHCI_INT_ST_REG	Masked interrupt status	0x3FF54008	0x3FF4C008	RO
UHCI_INT_ENA_REG	Interrupt enable bits	0x3FF5400C	0x3FF4C00C	R/W
UHCI_INT_CLR_REG	Interrupt clear bits	0x3FF54010	0x3FF4C010	WO



**Register 13.2. UART\_INT\_RAW\_REG (0x4)**

(reserved)																			UART_AT_CMD_CHAR_DET_INT_RAW UART_RS485_CLASH_INT_RAW UART_RS485_FRM_ERR_INT_RAW UART_RS485_PARITY_ERR_INT_RAW UART_TX_DONE_INT_RAW UART_TX_BRK_IDLE_DONE_INT_RAW UART_GLITCH_DET_INT_RAW UART_SW_XOFF_INT_RAW UART_SW_XON_INT_RAW UART_RXFIFO_TOUT_INT_RAW UART_BRK_DET_INT_RAW UART_CTS_CHG_INT_RAW UART_DSR_CHG_INT_RAW UART_FRM_ERR_INT_RAW UART_TXFIFO_EMPTY_INT_RAW UART_RXFIFO_FULL_INT_RAW																				
31																				19	18	17	16	15	14	13	12	11	10	9	8	7	6	5	4	3	2	1	0
0 0																																							

Reset

**UART\_AT\_CMD\_CHAR\_DET\_INT\_RAW** The raw interrupt status bit for the [UART\\_AT\\_CMD\\_CHAR\\_DET\\_INT](#) interrupt. (RO)

**UART\_RS485\_CLASH\_INT\_RAW** The raw interrupt status bit for the [UART\\_RS485\\_CLASH\\_INT](#) interrupt. (RO)

**UART\_RS485\_FRM\_ERR\_INT\_RAW** The raw interrupt status bit for the [UART\\_RS485\\_FRM\\_ERR\\_INT](#) interrupt. (RO)

**UART\_RS485\_PARITY\_ERR\_INT\_RAW** The raw interrupt status bit for the [UART\\_RS485\\_PARITY\\_ERR\\_INT](#) interrupt. (RO)

**UART\_TX\_DONE\_INT\_RAW** The raw interrupt status bit for the [UART\\_TX\\_DONE\\_INT](#) interrupt. (RO)

**UART\_TX\_BRK\_IDLE\_DONE\_INT\_RAW** The raw interrupt status bit for the [UART\\_TX\\_BRK\\_IDLE\\_DONE\\_INT](#) interrupt. (RO)

**UART\_TX\_BRK\_DONE\_INT\_RAW** The raw interrupt status bit for the [UART\\_TX\\_BRK\\_DONE\\_INT](#) interrupt. (RO)

**UART\_GLITCH\_DET\_INT\_RAW** The raw interrupt status bit for the [UART\\_GLITCH\\_DET\\_INT](#) interrupt. (RO)

**UART\_SW\_XOFF\_INT\_RAW** The raw interrupt status bit for the [UART\\_SW\\_XOFF\\_INT](#) interrupt. (RO)

**UART\_SW\_XON\_INT\_RAW** The raw interrupt status bit for the [UART\\_SW\\_XON\\_INT](#) interrupt. (RO)

**UART\_RXFIFO\_TOUT\_INT\_RAW** The raw interrupt status bit for the [UART\\_RXFIFO\\_TOUT\\_INT](#) interrupt. (RO)

**UART\_BRK\_DET\_INT\_RAW** The raw interrupt status bit for the [UART\\_BRK\\_DET\\_INT](#) interrupt. (RO)

**UART\_CTS\_CHG\_INT\_RAW** The raw interrupt status bit for the [UART\\_CTS\\_CHG\\_INT](#) interrupt. (RO)

**UART\_DSR\_CHG\_INT\_RAW** The raw interrupt status bit for the [UART\\_DSR\\_CHG\\_INT](#) interrupt. (RO)

**UART\_RXFIFO\_OVF\_INT\_RAW** The raw interrupt status bit for the [UART\\_RXFIFO\\_OVF\\_INT](#) interrupt. (RO)

**UART\_FRM\_ERR\_INT\_RAW** The raw interrupt status bit for the [UART\\_FRM\\_ERR\\_INT](#) interrupt. (RO)

Continued on the next page...

**Register 13.2. UART\_INT\_RAW\_REG (0x4)**

Continued from the previous page...

**UART\_PARITY\_ERR\_INT\_RAW** The raw interrupt status bit for the [UART\\_PARITY\\_ERR\\_INT](#) interrupt. (RO)

**UART\_TXFIFO\_EMPTY\_INT\_RAW** The raw interrupt status bit for the [UART\\_TXFIFO\\_EMPTY\\_INT](#) interrupt. (RO)

**UART\_RXFIFO\_FULL\_INT\_RAW** The raw interrupt status bit for the [UART\\_RXFIFO\\_FULL\\_INT](#) interrupt. (RO)



**Register 13.3. UART\_INT\_ST\_REG (0x8)**

Continued from the previous page...

**UART\_RXFIFO\_OVF\_INT\_ST** The masked interrupt status bit for the [UART\\_RXFIFO\\_OVF\\_INT](#) interrupt. (RO)

**UART\_FRM\_ERR\_INT\_ST** The masked interrupt status bit for the [UART\\_FRM\\_ERR\\_INT](#) interrupt. (RO)

**UART\_PARITY\_ERR\_INT\_ST** The masked interrupt status bit for the [UART\\_PARITY\\_ERR\\_INT](#) interrupt. (RO)

**UART\_TXFIFO\_EMPTY\_INT\_ST** The masked interrupt status bit for the [UART\\_TXFIFO\\_EMPTY\\_INT](#) interrupt. (RO)

**UART\_RXFIFO\_FULL\_INT\_ST** The masked interrupt status bit for [UART\\_RXFIFO\\_FULL\\_INT](#). (RO)

**Register 13.4. UART\_INT\_ENA\_REG (0xC)**

31	(reserved)																		0	Reset	
19	18	17	16	15	14	13	12	11	10	9	8	7	6	5	4	3	2	1	0		
0	0	0	0	0	0	0	0	0	0	0	0	0	0	0	0	0	0	0	0	0	0

**UART\_AT\_CMD\_CHAR\_DET\_INT\_ENA** The interrupt enable bit for the [UART\\_AT\\_CMD\\_CHAR\\_DET\\_INT](#) interrupt. (R/W)

**UART\_RS485\_CLASH\_INT\_ENA** The interrupt enable bit for the [UART\\_RS485\\_CLASH\\_INT](#) interrupt. (R/W)

**UART\_RS485\_FRM\_ERR\_INT\_ENA** The interrupt enable bit for the [UART\\_RS485\\_FRM\\_ERR\\_INT](#) interrupt. (R/W)

**UART\_RS485\_PARITY\_ERR\_INT\_ENA** The interrupt enable bit for the [UART\\_RS485\\_PARITY\\_ERR\\_INT](#) interrupt. (R/W)

**UART\_TX\_DONE\_INT\_ENA** The interrupt enable bit for the [UART\\_TX\\_DONE\\_INT](#) interrupt. (R/W)

**UART\_TX\_BRK\_IDLE\_DONE\_INT\_ENA** The interrupt enable bit for the [UART\\_TX\\_BRK\\_IDLE\\_DONE\\_INT](#) interrupt. (R/W)

**UART\_TX\_BRK\_DONE\_INT\_ENA** The interrupt enable bit for the [UART\\_TX\\_BRK\\_DONE\\_INT](#) interrupt. (R/W)

**UART\_GLITCH\_DET\_INT\_ENA** The interrupt enable bit for the [UART\\_GLITCH\\_DET\\_INT](#) interrupt. (R/W)

**UART\_SW\_XOFF\_INT\_ENA** The interrupt enable bit for the [UART\\_SW\\_XOFF\\_INT](#) interrupt. (R/W)

**UART\_SW\_XON\_INT\_ENA** The interrupt enable bit for the [UART\\_SW\\_XON\\_INT](#) interrupt. (R/W)

**UART\_RXFIFO\_TOUT\_INT\_ENA** The interrupt enable bit for the [UART\\_RXFIFO\\_TOUT\\_INT](#) interrupt. (R/W)

**UART\_BRK\_DET\_INT\_ENA** The interrupt enable bit for the [UART\\_BRK\\_DET\\_INT](#) interrupt. (R/W)

**UART\_CTS\_CHG\_INT\_ENA** The interrupt enable bit for the [UART\\_CTS\\_CHG\\_INT](#) interrupt. (R/W)

**UART\_DSR\_CHG\_INT\_ENA** The interrupt enable bit for the [UART\\_DSR\\_CHG\\_INT](#) interrupt. (R/W)

**UART\_RXFIFO\_OVF\_INT\_ENA** The interrupt enable bit for the [UART\\_RXFIFO\\_OVF\\_INT](#) interrupt. (R/W)

**UART\_FRM\_ERR\_INT\_ENA** The interrupt enable bit for the [UART\\_FRM\\_ERR\\_INT](#) interrupt. (R/W)

**UART\_PARITY\_ERR\_INT\_ENA** The interrupt enable bit for the [UART\\_PARITY\\_ERR\\_INT](#) interrupt. (R/W)

Continued on the next page...

#### Register 13.4. UART\_INT\_ENA\_REG (0xC)

Continued from the previous page...

**UART\_TXFIFO\_EMPTY\_INT\_ENA** The interrupt enable bit for the [UART\\_TXFIFO\\_EMPTY\\_INT](#) interrupt. (R/W)

**UART\_RXFIFO\_FULL\_INT\_ENA** The interrupt enable bit for the [UART\\_RXFIFO\\_FULL\\_INT](#) interrupt. (R/W)





**Register 13.6. UART\_CLKDIV\_REG (0x14)**

(reserved)								UART_CLKDIV_FRAG				UART_CLKDIV										
31								24	23				20	19								0
0	0	0	0	0	0	0	0	0x00	0x0002B6								0	Reset				

**UART\_CLKDIV\_FRAG** The decimal part of the frequency divider factor. (R/W)

**UART\_CLKDIV** The integral part of the frequency divider factor. (R/W)

**Register 13.7. UART\_AUTOBAUD\_REG (0x18)**

(reserved)														UART_GLITCH_FILT				(reserved)				UART_AUTOBAUD_EN						
31														16	15				8	7				1	0			
0	0	0	0	0	0	0	0	0	0	0	0	0	0	0	0	0	0	0x010	0	0	0	0	0	0	0	0	0	Reset

**UART\_GLITCH\_FILT** When the input pulse width is lower than this value, the pulse is ignored. This register is used in the autobauding process. (R/W)

**UART\_AUTOBAUD\_EN** This is the enable bit for autobaud. (R/W)

**Register 13.8. UART\_STATUS\_REG (0x1C)**

UART_TXD			UART_RTSN			UART_DTRN (reserved)			UART_ST_UTX_OUT				UART_TXFIFO_CNT								UART_RXD				UART_CTSN				UART_DSRN (reserved)				UART_ST_URX_OUT				UART_RXFIFO_CNT							
31	30	29	28	27	26	25	24	23	22	21	20	19	18	17	16	15	14	13	12	11	10	9	8	7	6	5	4	3	2	1	0													
0	0	0	0	0	0	0	0	0	0	0	0	0	0	0	0	0	0	0	0	0	0	0	0	0	0	0	0	0	0	0	0	0												

Reset

**UART\_TXD** This bit represents the level of the internal UART RxD signal. (RO)

**UART\_RTSN** This bit corresponds to the level of the internal UART CTS signal. (RO)

**UART\_DTRN** This bit corresponds to the level of the internal UAR DSR signal. (RO)

**UART\_ST\_UTX\_OUT** This register stores the state of the transmitter's finite state machine. 0: TX\_IDLE; 1: TX\_STRT; 2: TX\_DAT0; 3: TX\_DAT1; 4: TX\_DAT2; 5: TX\_DAT3; 6: TX\_DAT4; 7: TX\_DAT5; 8: TX\_DAT6; 9: TX\_DAT7; 10: TX\_PRTY; 11: TX\_STP1; 12: TX\_STP2; 13: TX\_DL0; 14: TX\_DL1. (RO)

**UART\_TXFIFO\_CNT** (tx\_mem\_cnt, txfifo\_cnt) stores the number of bytes of valid data in transmit-FIFO. tx\_mem\_cnt stores the three most significant bits, txfifo\_cnt stores the eight least significant bits. (RO)

**UART\_RXD** This bit corresponds to the level of the internal UART RxD signal. (RO)

**UART\_CTSN** This bit corresponds to the level of the internal UART CTS signal. (RO)

**UART\_DSRN** This bit corresponds to the level of the internal UAR DSR signal. (RO)

**UART\_ST\_URX\_OUT** This register stores the value of the receiver's finite state machine. 0: RX\_IDLE; 1: RX\_STRT; 2: RX\_DAT0; 3: RX\_DAT1; 4: RX\_DAT2; 5: RX\_DAT3; 6: RX\_DAT4; 7: RX\_DAT5; 8: RX\_DAT6; 9: RX\_DAT7; 10: RX\_PRTY; 11: RX\_STP1; 12:RX\_STP2; 13: RX\_DL1. (RO)

**UART\_RXFIFO\_CNT** (rx\_mem\_cnt, rxfifo\_cnt) stores the number of bytes of valid data in the receive-FIFO. rx\_mem\_cnt register stores the three most significant bits, rxfifo\_cnt stores the eight least significant bits. (RO)

Register 13.9. UART\_CONF0\_REG (0x20)

(reserved)	UART_TICK_REF_ALWAYS_ON	(reserved)	UART_DTR_INV	UART_RTS_INV	UART_TXD_INV	UART_DSR_INV	UART_CTS_INV	UART_RXD_INV	UART_TXFIFO_RST	UART_RXFIFO_RST	UART_IRDA_EN	UART_TX_FLOW_EN	UART_LOOPBACK	UART_IRDA_RX_INV	UART_IRDA_TX_INV	UART_IRDA_WCTL	UART_IRDA_TX_EN	UART_TXD_DPLX	UART_SW_BRK	UART_SW_DTR	UART_STOP_BIT_NUM	UART_BIT_NUM	UART_PARITY_EN	UART_PARITY					
31	28	27	26	25	24	23	22	21	20	19	18	17	16	15	14	13	12	11	10	9	8	7	6	5	4	3	2	1	0
0	0	0	0	1	0	0	0	0	0	0	0	0	0	0	0	0	0	0	0	0	0	0	0	0	1	3	0	0	Reset

**UART\_TICK\_REF\_ALWAYS\_ON** This register is used to select the clock; 1: APB clock; 0: REF\_TICK. (R/W)

**UART\_DTR\_INV** Set this bit to invert the level of the UART DTR signal. (R/W)

**UART\_RTS\_INV** Set this bit to invert the level of the UART RTS signal. (R/W)

**UART\_TXD\_INV** Set this bit to invert the level of the UART TxD signal. (R/W)

**UART\_DSR\_INV** Set this bit to invert the level of the UART DSR signal. (R/W)

**UART\_CTS\_INV** Set this bit to invert the level of the UART CTS signal. (R/W)

**UART\_RXD\_INV** Set this bit to invert the level of the UART Rxd signal. (R/W)

**UART\_TXFIFO\_RST** Set this bit to reset the UART transmit-FIFO. **NOTICE:** UART2 doesn't have any register to reset Tx\_FIFO or Rx\_FIFO, and the UART1\_TXFIFO\_RST and UART1\_RXFIFO\_RST in UART1 may impact the functioning of UART2. Therefore, these two registers in UART1 should only be used when the Tx\_FIFO and Rx\_FIFO in UART2 do not have any data. (R/W)

**UART\_RXFIFO\_RST** Set this bit to reset the UART receive-FIFO. **NOTICE:** UART2 doesn't have any register to reset Tx\_FIFO or Rx\_FIFO, and the UART1\_TXFIFO\_RST and UART1\_RXFIFO\_RST in UART1 may impact the functioning of UART2. Therefore, these two registers in UART1 should only be used when the Tx\_FIFO and Rx\_FIFO in UART2 do not have any data. (R/W)

**UART\_IRDA\_EN** Set this bit to enable the IrDA protocol. (R/W)

**UART\_TX\_FLOW\_EN** Set this bit to enable the flow control function for the transmitter. (R/W)

**UART\_LOOPBACK** Set this bit to enable the UART loopback test mode. (R/W)

**UART\_IRDA\_RX\_INV** Set this bit to invert the level of the IrDA receiver. (R/W)

**UART\_IRDA\_TX\_INV** Set this bit to invert the level of the IrDA transmitter. (R/W)

**UART\_IRDA\_WCTL** 1: The IrDA transmitter's 11th bit is the same as its 10th bit; 0: set IrDA transmitter's 11th bit to 0. (R/W)

**UART\_IRDA\_TX\_EN** This is the start enable bit of the IrDA transmitter. (R/W)

**UART\_IRDA\_DPLX** Set this bit to enable the IrDA loopback mode. (R/W)

**UART\_TXD\_BRK** Set this bit to enable the transmitter to send NULL, when the process of sending data is completed. (R/W)

Continued on the next page...

**Register 13.9. UART\_CONF0\_REG (0x20)**

Continued from the previous page...

**UART\_SW\_DTR** This register is used to configure the software DTR signal used in software flow control. (R/W)

**UART\_SW\_RTS** This bit is used in hardware flow control when UART\_RX\_FLOW\_EN is 0. Set this bit to drive the RTS (or rtsn\_out) signal low, and reset to drive the signal high. (R/W)

**UART\_STOP\_BIT\_NUM** This register is used to set the length of the stop bit; 1: 1 bit, 2: 1.5 bits. (R/W)

**UART\_BIT\_NUM** This register is used to set the length of data; 0: 5 bits, 1: 6 bits, 2: 7 bits, 3: 8 bits. (R/W)

**UART\_PARITY\_EN** Set this bit to enable the UART parity check. (R/W)

**UART\_PARITY** This register is used to configure the parity check mode; 0: even, 1: odd. (R/W)

**Register 13.10. UART\_CONF1\_REG (0x24)**

UART_RX_TOUT_EN				UART_RX_TOUT_THRHD				UART_RX_FLOW_EN				UART_RX_FLOW_THRHD				(reserved)				UART_TXFIFO_EMPTY_THRHD				(reserved)				UART_RXFIFO_FULL_THRHD																			
31	30	24	23	22	16	15	14	8	7	6	0	31	30	24	23	22	16	15	14	8	7	6	0																								
0	0	0	0	0	0	0	0	0	0	0	0	0	0	0	0	0	0	0	0	0	0	0	0	0	0	0	0	0	0	0	0	0	0	0	0	0	0	0	0	0	0	0	0	0	0	0	0

Reset

**UART\_RX\_TOUT\_EN** This is the enable bit for the UART receive-timeout function. (R/W)

**UART\_RX\_TOUT\_THRHD** This register is used to configure the UART receiver's timeout value when receiving a byte. When using APB\_CLK as the clock source, the register counts by UART baud cycle multiplied by 8. When using REF\_TICK as the clock source, the register counts by UART baud cycle \* 8 \* (REF\_TICK frequency)/(APB\_CLK frequency). (R/W)

**UART\_RX\_FLOW\_EN** This is the flow enable bit of the UART receiver; 1: choose software flow control by configuring the sw\_rts signal; 0: disable software flow control. (R/W)

**UART\_RX\_FLOW\_THRHD** When UART\_RX\_FLOW\_EN is 1 and the receiver gets more data than its threshold value, the receiver produces an rtsn\_out signal that tells the transmitter to stop transferring data. The threshold value is (rx\_flow\_thrhd\_h3, rx\_flow\_thrhd). (R/W)

**UART\_TXFIFO\_EMPTY\_THRHD** When the data amount in transmit-FIFO is less than its threshold value, it will produce a TXFIFO\_EMPTY\_INT\_RAW interrupt. The threshold value is (tx\_mem\_empty\_thrhd, txfifo\_empty\_thrhd). (R/W)

**UART\_RXFIFO\_FULL\_THRHD** When the receiver gets more data than its threshold value, the receiver will produce an RXFIFO\_FULL\_INT\_RAW interrupt. The threshold value is (rx\_flow\_thrhd\_h3, rxfifo\_full\_thrhd). (R/W)

**Register 13.11. UART\_LOWPULSE\_REG (0x28)**

(reserved)												UART_LOWPULSE_MIN_CNT											
31	20	19	0	31	20	19	0																
0	0	0	0	0	0	0	0	0	0	0	0	0	0	0	0								

Reset

**UART\_LOWPULSE\_MIN\_CNT** This register stores the value of the minimum duration of the low-level pulse. It is used in the baud rate detection process. (RO)







**Register 13.16. UART\_SWFC\_CONF\_REG (0x3C)**

<i>UART_XOFF_CHAR</i>				<i>UART_XON_CHAR</i>				<i>UART_XOFF_THRESHOLD</i>				<i>UART_XON_THRESHOLD</i>			
31	24	23	16	15	8	7	0	31	24	23	16	15	8	7	0
0x013				0x011				0x0E0				0x000			
Reset															

**UART\_XOFF\_CHAR** This register stores the Xoff flow control char. (R/W)

**UART\_XON\_CHAR** This register stores the Xon flow control char. (R/W)

**UART\_XOFF\_THRESHOLD** When the data amount in receive-FIFO is more than what this register indicates, it will send an Xoff char, with `uart_sw_flow_con_en` set to 1. (R/W)

**UART\_XON\_THRESHOLD** When the data amount in receive-FIFO is less than what this register indicates, it will send an Xon char, with `uart_sw_flow_con_en` set to 1. (R/W)

**Register 13.17. UART\_IDLE\_CONF\_REG (0x40)**

<i>(reserved)</i>				<i>UART_TX_BRK_NUM</i>				<i>UART_TX_IDLE_NUM</i>				<i>UART_RX_IDLE_THRHD</i>			
31	28	27	20	19	10	9	0	31	24	23	16	15	8	7	0
0 0 0 0				0x00A				0x100				0x100			
Reset															

**UART\_TX\_BRK\_NUM** This register is used to configure the number of zeros (0) sent, after the process of sending data is completed. It is active when `txd_brk` is set to 1. (R/W)

**UART\_TX\_IDLE\_NUM** This register is used to configure the duration between transfers. (R/W)

**UART\_RX\_IDLE\_THRHD** When the receiver takes more time to receive Byte data than what this register indicates, it will produce a frame-end signal. (R/W)

Register 13.18. UART\_RS485\_CONF\_REG (0x44)

(reserved)										UART_RS485_TX_DLY_NUM	UART_RS485_RX_DLY_NUM	UART_RS485RXBY_TX_EN	UART_RS485TX_RX_EN	UART_DL1_EN	UART_DL0_EN	UART_RS485_EN				
31	24	23	22	21	20	19	18	17	16	15	10	9	6	5	4	3	2	1	0	
0	0	0	0	0	0	0	0	0	0	0	0	0	0	0	0	0	0	0	0	0

Reset

**UART\_RS485\_TX\_DLY\_NUM** This register is used to delay the transmitter's internal data signal. (R/W)

**UART\_RS485\_RX\_DLY\_NUM** This register is used to delay the receiver's internal data signal. (R/W)

**UART\_RS485RXBY\_TX\_EN** 1: enable the RS-485 transmitter to send data, when the RS-485 receiver line is busy; 0: the RS-485 transmitter should not send data, when its receiver is busy. (R/W)

**UART\_RS485TX\_RX\_EN** Set this bit to enable the transmitter's output signal loop back to the receiver's input signal. (R/W)

**UART\_DL1\_EN** Set this bit to delay the STOP bit by 1 bit. (R/W)

**UART\_DL0\_EN** Set this bit to delay the STOP bit by 1 bit after DL1. (R/W)

**UART\_RS485\_EN** Set this bit to choose the RS-485 mode. (R/W)

Register 13.19. UART\_AT\_CMD\_PRECNT\_REG (0x48)

(reserved)								UART_PRE_IDLE_NUM
31	24	23	22	21	20	19	18	0
0	0	0	0	0	0	0	0	0x0186A00

Reset

**UART\_PRE\_IDLE\_NUM** This register is used to configure the idle-time duration before the first at\_cmd is received by the receiver. When the duration is less than what this register indicates, it will not take the next data received as an at\_cmd char. (R/W)

**Register 13.20. UART\_AT\_CMD\_POSTCNT\_REG (0x4c)**

(reserved)								UART_POST_IDLE_NUM																0	
31								24																23	0
0 0 0 0 0 0 0 0								0x0186A00																Reset	

**UART\_POST\_IDLE\_NUM** This register is used to configure the duration between the last at\_cmd and the next data. When the duration is less than what this register indicates, it will not take the previous data as an at\_cmd char. (R/W)

**Register 13.21. UART\_AT\_CMD\_GAPTOU\_REG (0x50)**

(reserved)								UART_RX_GAP_TOUT																0	
31								24																23	0
0 0 0 0 0 0 0 0								0x0001E00																Reset	

**UART\_RX\_GAP\_TOUT** This register is used to configure the interval between the at\_cmd chars. When the interval is greater than the value of this register, it will not take the data as continuous at\_cmd chars. The register should be configured to more than half of the baud rate. (R/W)

**Register 13.22. UART\_AT\_CMD\_CHAR\_REG (0x54)**

(reserved)																UART_CHAR_NUM								UART_AT_CMD_CHAR								0									
31																16								15								8								7	0
0 0 0 0 0 0 0 0 0 0 0 0 0 0 0 0																0x003								0x02B								Reset									

**UART\_CHAR\_NUM** This register is used to configure the number of continuous at\_cmd chars received by the receiver. (R/W)

**UART\_AT\_CMD\_CHAR** This register is used to configure the content of an at\_cmd char. (R/W)

**Register 13.23. UART\_MEM\_CONF\_REG (0x58)**

(reserved)		UART_TX_MEM_EMPTY_THRHD		UART_RX_MEM_FULL_THRHD		UART_XOFF_THRESHOLD_H2		UART_XON_THRESHOLD_H2		UART_RX_TOUT_THRHD_H3		UART_RX_FLOW_THRHD_H3		(reserved)		UART_TX_SIZE		UART_RX_SIZE		(reserved)		UART_MEM_PD	
31	30	28	27	25	24	23	22	21	20	18	17	15	14	11	10	7	6	3	2	1	0	Reset	
0	0x0	0x0	0x0	0x0	0x0	0x0	0x0	0x0	0x0	0	0	0	0	0x01	0x01	0x01	0x01	0	0	0	0	0	0

**UART\_TX\_MEM\_EMPTY\_THRHD** Refer to the description of [TXFIFO\\_EMPTY\\_THRHD](#). (R/W)

**UART\_RX\_MEM\_FULL\_THRHD** Refer to the description of [RXFIFO\\_FULL\\_THRHD](#). (R/W)

**UART\_XOFF\_THRESHOLD\_H2** Refer to the description of [UART\\_XOFF\\_THRESHOLD](#). (R/W)

**UART\_XON\_THRESHOLD\_H2** Refer to the description of [UART\\_XON\\_THRESHOLD](#). (R/W)

**UART\_RX\_TOUT\_THRHD\_H3** Refer to the description of [RX\\_TOUT\\_THRHD](#). (R/W)

**UART\_RX\_FLOW\_THRHD\_H3** Refer to the description of [RX\\_FLOW\\_THRHD](#). (R/W)

**UART\_TX\_SIZE** This register is used to configure the amount of memory allocated to the transmit-FIFO. The default number is 128 bytes. (R/W)

**UART\_RX\_SIZE** This register is used to configure the amount of memory allocated to the receive-FIFO. The default number is 128 bytes. (R/W)

**UART\_MEM\_PD** Set this bit to power down the memory. When the reg\_mem\_pd register is set to 1 for all UART controllers, Memory will enter the low-power mode. (R/W)

**Register 13.24. UART\_MEM\_CNT\_STATUS\_REG (0x64)**

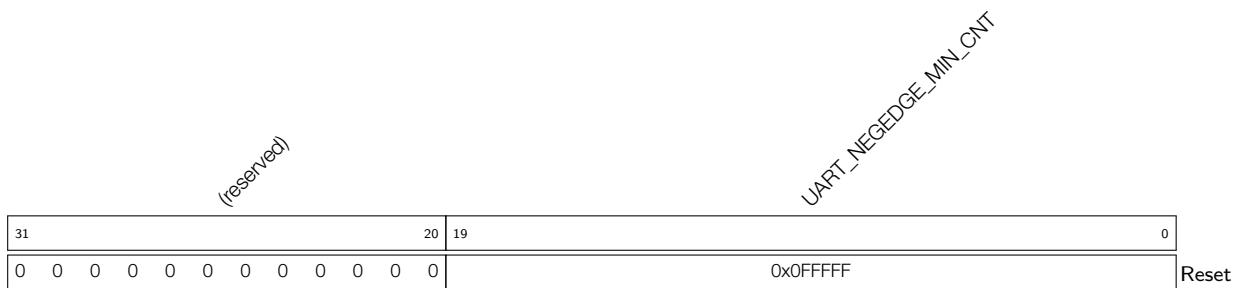
(reserved)																UART_TX_MEM_CNT		UART_RX_MEM_CNT					
31															6	5	3	2	0	Reset			
0	0	0	0	0	0	0	0	0	0	0	0	0	0	0	0	0	0	0	0	0	0	0	0

**UART\_TX\_MEM\_CNT** Refer to the description of [TXFIFO\\_CNT](#). (RO)

**UART\_RX\_MEM\_CNT** Refer to the description of [RXFIFO\\_CNT](#). (RO)

**Register 13.25. UART\_POSPULSE\_REG (0x68)**

**UART\_POSEDGE\_MIN\_CNT** This register stores the count of RxD positive edges. It is used in the autobaud detection process. (RO)

**Register 13.26. UART\_NEGPULSE\_REG (0x6c)**

**UART\_NEGEDGE\_MIN\_CNT** This register stores the count of RxD negative edges. It is used in the autobaud detection process. (RO)

**Register 13.27. UHCI\_CONF0\_REG (0x0)**

(reserved)										UHCI_ENCODE_CRC_EN UHCI_LEN_EOF_EN UHCI_UART_IDLE_EOF_EN UHCI_CRC_REC_EN UHCI_HEAD_EN UHCI_SEPER_EN							(reserved)			UHCI_UART2_CE UHCI_UART1_CE UHCI_UART0_CE			(reserved)							
31																														0
0	0	0	0	0	0	0	0	0	0	1	1	0	1	1	1	0	0	0	0	0	0	0	0	0	0	0	0	0	0	Reset

- UHCI\_ENCODE\_CRC\_EN** Reserved. Please initialize it to 0. (R/W)
- UHCI\_LEN\_EOF\_EN** Reserved. Please initialize it to 0. (R/W)
- UHCI\_UART\_IDLE\_EOF\_EN** Reserved. Please initialize it to 0. (R/W)
- UHCI\_CRC\_REC\_EN** Reserved. Please initialize it to 0. (R/W)
- UHCI\_HEAD\_EN** Reserved. Please initialize it to 0. (R/W)
- UHCI\_SEPER\_EN** Set this bit to use a special char and separate the data frame. (R/W)
- UHCI\_UART2\_CE** Set this bit to use UART2 and transmit or receive data. (R/W)
- UHCI\_UART1\_CE** Set this bit to use UART1 and transmit or receive data. (R/W)
- UHCI\_UART0\_CE** Set this bit to use UART and transmit or receive data. (R/W)

## Register 13.28. UHCI\_INT\_RAW\_REG (0x4)

(reserved)														UHCI_OUT_TOTAL_EOF_INT_RAW	UHCI_OUTLINK_EOF_ERR_INT_RAW	UHCI_IN_DSCR_EMPTY_INT_RAW	UHCI_OUT_DSCR_ERR_INT_RAW	UHCI_IN_DSCR_ERR_INT_RAW	UHCI_OUT_EOF_INT_RAW	UHCI_OUT_DONE_INT_RAW	UHCI_IN_ERR_EOF_INT_RAW	UHCI_IN_SUC_EOF_INT_RAW	UHCI_IN_DONE_INT_RAW	UHCI_TX_HUNG_INT_RAW	UHCI_RX_HUNG_INT_RAW	UHCI_TX_START_INT_RAW	UHCI_RX_START_INT_RAW					
31	30	29	28	27	26	25	24	23	22	21	20	19	18	17	16	15	14	13	12	11	10	9	8	7	6	5	4	3	2	1	0	Reset
0	0	0	0	0	0	0	0	0	0	0	0	0	0	0	0	0	0	0	0	0	0	0	0	0	0	0	0	0	0	0	0	0

**UHCI\_OUT\_TOTAL\_EOF\_INT\_RAW** The raw interrupt status bit for the [UHCI\\_OUT\\_TOTAL\\_EOF\\_INT](#) interrupt. (RO)

**UHCI\_OUTLINK\_EOF\_ERR\_INT\_RAW** The raw interrupt status bit for the [UHCI\\_OUTLINK\\_EOF\\_ERR\\_INT](#) interrupt. (RO)

**UHCI\_IN\_DSCR\_EMPTY\_INT\_RAW** The raw interrupt status bit for the [UHCI\\_IN\\_DSCR\\_EMPTY\\_INT](#) interrupt. (RO)

**UHCI\_OUT\_DSCR\_ERR\_INT\_RAW** The raw interrupt status bit for the [UHCI\\_OUT\\_DSCR\\_ERR\\_INT](#) interrupt. (RO)

**UHCI\_IN\_DSCR\_ERR\_INT\_RAW** The raw interrupt status bit for the [UHCI\\_IN\\_DSCR\\_ERR\\_INT](#) interrupt. (RO)

**UHCI\_OUT\_EOF\_INT\_RAW** The raw interrupt status bit for the [UHCI\\_OUT\\_EOF\\_INT](#) interrupt. (RO)

**UHCI\_OUT\_DONE\_INT\_RAW** The raw interrupt status bit for the [UHCI\\_OUT\\_DONE\\_INT](#) interrupt. (RO)

**UHCI\_IN\_ERR\_EOF\_INT\_RAW** The raw interrupt status bit for the [UHCI\\_IN\\_ERR\\_EOF\\_INT](#) interrupt. (RO)

**UHCI\_IN\_SUC\_EOF\_INT\_RAW** The raw interrupt status bit for the [UHCI\\_IN\\_SUC\\_EOF\\_INT](#) interrupt. (RO)

**UHCI\_IN\_DONE\_INT\_RAW** The raw interrupt status bit for the [UHCI\\_IN\\_DONE\\_INT](#) interrupt. (RO)

**UHCI\_TX\_HUNG\_INT\_RAW** The raw interrupt status bit for the [UHCI\\_TX\\_HUNG\\_INT](#) interrupt. (RO)

**UHCI\_RX\_HUNG\_INT\_RAW** The raw interrupt status bit for the [UHCI\\_RX\\_HUNG\\_INT](#) interrupt. (RO)

**UHCI\_TX\_START\_INT\_RAW** The raw interrupt status bit for the [UHCI\\_TX\\_START\\_INT](#) interrupt. (RO)

**UHCI\_RX\_START\_INT\_RAW** The raw interrupt status bit for the [UHCI\\_RX\\_START\\_INT](#) interrupt. (RO)

**Register 13.29. UHCI\_INT\_ST\_REG (0x8)**

(reserved)																	UHCI_DMA_INFO_FULL_WM_INT_ST	UHCI_SEND_A_REG_Q_INT_ST	UHCI_SEND_S_REG_Q_INT_ST	UHCI_OUT_TOTAL_EOF_INT_ST	UHCI_OUTLINK_EOF_ERR_INT_ST	UHCI_IN_DSCR_EMPTY_INT_ST	UHCI_OUT_DSCR_ERR_INT_ST	UHCI_OUT_EOF_DONE_INT_ST	UHCI_IN_ERR_EOF_INT_ST	UHCI_IN_SUC_EOF_INT_ST	UHCI_IN_DONE_EOF_INT_ST	UHCI_TX_HUNG_INT_ST	UHCI_RX_HUNG_INT_ST	UHCI_TX_START_INT_ST	UHCI_RX_START_INT_ST														
31																	17	16	15	14	13	12	11	10	9	8	7	6	5	4	3	2	1	0	Reset										
0																	0	0	0	0	0	0	0	0	0	0	0	0	0	0	0	0	0	0	0	0	0	0	0	0	0	0	0	0	0

**UHCI\_SEND\_A\_REG\_Q\_INT\_ST** The masked interrupt status bit for the [UHCI\\_SEND\\_A\\_REG\\_Q\\_INT](#) interrupt. (RO)

**UHCI\_SEND\_S\_REG\_Q\_INT\_ST** The masked interrupt status bit for the [UHCI\\_SEND\\_S\\_REG\\_Q\\_INT](#) interrupt. (RO)

**UHCI\_OUT\_TOTAL\_EOF\_INT\_ST** The masked interrupt status bit for the [UHCI\\_OUT\\_TOTAL\\_EOF\\_INT](#) interrupt. (RO)

**UHCI\_OUTLINK\_EOF\_ERR\_INT\_ST** The masked interrupt status bit for the [UHCI\\_OUTLINK\\_EOF\\_ERR\\_INT](#) interrupt. (RO)

**UHCI\_IN\_DSCR\_EMPTY\_INT\_ST** The masked interrupt status bit for the [UHCI\\_IN\\_DSCR\\_EMPTY\\_INT](#) interrupt. (RO)

**UHCI\_OUT\_DSCR\_ERR\_INT\_ST** The masked interrupt status bit for the [UHCI\\_OUT\\_DSCR\\_ERR\\_INT](#) interrupt. (RO)

**UHCI\_IN\_DSCR\_ERR\_INT\_ST** The masked interrupt status bit for the [UHCI\\_IN\\_DSCR\\_ERR\\_INT](#) interrupt. (RO)

**UHCI\_OUT\_EOF\_INT\_ST** The masked interrupt status bit for the [UHCI\\_OUT\\_EOF\\_INT](#) interrupt. (RO)

**UHCI\_OUT\_DONE\_INT\_ST** The masked interrupt status bit for the [UHCI\\_OUT\\_DONE\\_INT](#) interrupt. (RO)

**UHCI\_IN\_ERR\_EOF\_INT\_ST** The masked interrupt status bit for the [UHCI\\_IN\\_ERR\\_EOF\\_INT](#) interrupt. (RO)

**UHCI\_IN\_SUC\_EOF\_INT\_ST** The masked interrupt status bit for the [UHCI\\_IN\\_SUC\\_EOF\\_INT](#) interrupt. (RO)

**UHCI\_IN\_DONE\_INT\_ST** The masked interrupt status bit for the [UHCI\\_IN\\_DONE\\_INT](#) interrupt. (RO)

**UHCI\_TX\_HUNG\_INT\_ST** The masked interrupt status bit for the [UHCI\\_TX\\_HUNG\\_INT](#) interrupt. (RO)

**UHCI\_RX\_HUNG\_INT\_ST** The masked interrupt status bit for the [UHCI\\_RX\\_HUNG\\_INT](#) interrupt. (RO)

Continued on the next page...



**Register 13.29. UHCI\_INT\_ST\_REG (0x8)**

Continued from the previous page...

**UHCI\_TX\_START\_INT\_ST** The masked interrupt status bit for the [UHCI\\_TX\\_START\\_INT](#) interrupt.  
(RO)

**UHCI\_RX\_START\_INT\_ST** The masked interrupt status bit for the [UHCI\\_RX\\_START\\_INT](#) interrupt.  
(RO)

**Register 13.30. UHCI\_INT\_ENA\_REG (0xC)**

<i>(reserved)</i>																	<i>UHCI_DMA_INFO_FULL_WM_INT_ENA</i> <i>UHCI_SEND_A_REG_Q_INT_ENA</i> <i>UHCI_SEND_S_REG_Q_INT_ENA</i> <i>UHCI_OUT_TOTAL_EOF_INT_ENA</i> <i>UHCI_OUTLINK_EOF_ERR_INT_ENA</i> <i>UHCI_IN_DSCR_EMPTY_INT_ENA</i> <i>UHCI_OUT_DSCR_ERR_INT_ENA</i> <i>UHCI_OUT_EOF_INT_ENA</i> <i>UHCI_IN_DSCR_ERR_INT_ENA</i> <i>UHCI_OUT_DONE_INT_ENA</i> <i>UHCI_IN_SUC_EOF_INT_ENA</i> <i>UHCI_IN_DONE_INT_ENA</i> <i>UHCI_TX_HUNG_INT_ENA</i> <i>UHCI_RX_HUNG_INT_ENA</i> <i>UHCI_TX_START_INT_ENA</i> <i>UHCI_RX_START_INT_ENA</i>																		
31																	17	16	15	14	13	12	11	10	9	8	7	6	5	4	3	2	1	0	Reset
0	0	0	0	0	0	0	0	0	0	0	0	0	0	0	0	0	0	0	0	0	0	0	0	0	0	0	0	0	0	0	0	0	0	0	

- UHCI\_SEND\_A\_REG\_Q\_INT\_ENA** The interrupt enable bit for the [UHCI\\_SEND\\_A\\_REG\\_Q\\_INT](#) interrupt. (R/W)
- UHCI\_SEND\_S\_REG\_Q\_INT\_ENA** The interrupt enable bit for the [UHCI\\_SEND\\_S\\_REG\\_Q\\_INT](#) interrupt. (R/W)
- UHCI\_OUT\_TOTAL\_EOF\_INT\_ENA** The interrupt enable bit for the [UHCI\\_OUT\\_TOTAL\\_EOF\\_INT](#) interrupt. (R/W)
- UHCI\_OUTLINK\_EOF\_ERR\_INT\_ENA** The interrupt enable bit for the [UHCI\\_OUTLINK\\_EOF\\_ERR\\_INT](#) interrupt. (R/W)
- UHCI\_IN\_DSCR\_EMPTY\_INT\_ENA** The interrupt enable bit for the [UHCI\\_IN\\_DSCR\\_EMPTY\\_INT](#) interrupt. (R/W)
- UHCI\_OUT\_DSCR\_ERR\_INT\_ENA** The interrupt enable bit for the [UHCI\\_OUT\\_DSCR\\_ERR\\_INT](#) interrupt. (R/W)
- UHCI\_IN\_DSCR\_ERR\_INT\_ENA** The interrupt enable bit for the [UHCI\\_IN\\_DSCR\\_ERR\\_INT](#) interrupt. (R/W)
- UHCI\_OUT\_EOF\_INT\_ENA** The interrupt enable bit for the [UHCI\\_OUT\\_EOF\\_INT](#) interrupt. (R/W)
- UHCI\_OUT\_DONE\_INT\_ENA** The interrupt enable bit for the [UHCI\\_OUT\\_DONE\\_INT](#) interrupt. (R/W)
- UHCI\_IN\_ERR\_EOF\_INT\_ENA** The interrupt enable bit for the [UHCI\\_IN\\_ERR\\_EOF\\_INT](#) interrupt. (R/W)
- UHCI\_IN\_SUC\_EOF\_INT\_ENA** The interrupt enable bit for the [UHCI\\_IN\\_SUC\\_EOF\\_INT](#) interrupt. (R/W)
- UHCI\_IN\_DONE\_INT\_ENA** The interrupt enable bit for the [UHCI\\_IN\\_DONE\\_INT](#) interrupt. (R/W)
- UHCI\_TX\_HUNG\_INT\_ENA** The interrupt enable bit for the [UHCI\\_TX\\_HUNG\\_INT](#) interrupt. (R/W)
- UHCI\_RX\_HUNG\_INT\_ENA** The interrupt enable bit for the [UHCI\\_RX\\_HUNG\\_INT](#) interrupt. (R/W)
- UHCI\_TX\_START\_INT\_ENA** The interrupt enable bit for the [UHCI\\_TX\\_START\\_INT](#) interrupt. (R/W)
- UHCI\_RX\_START\_INT\_ENA** The interrupt enable bit for the [UHCI\\_RX\\_START\\_INT](#) interrupt. (R/W)

Register 13.31. UHCI\_INT\_CLR\_REG (0x10)

(reserved)																	<div style="display: flex; justify-content: space-between;"> <div style="writing-mode: vertical-rl; transform: rotate(180deg);">UHCI_DMA_INFIFO_FULL_WM_INT_CLR</div> <div style="writing-mode: vertical-rl; transform: rotate(180deg);">UHCI_SEND_A_REG_Q_INT_CLR</div> <div style="writing-mode: vertical-rl; transform: rotate(180deg);">UHCI_SEND_S_REG_Q_INT_CLR</div> <div style="writing-mode: vertical-rl; transform: rotate(180deg);">UHCI_OUT_TOTAL_EOF_INT_CLR</div> <div style="writing-mode: vertical-rl; transform: rotate(180deg);">UHCI_OUTLINK_EOF_ERR_INT_CLR</div> <div style="writing-mode: vertical-rl; transform: rotate(180deg);">UHCI_IN_DSCR_EMPTY_INT_CLR</div> <div style="writing-mode: vertical-rl; transform: rotate(180deg);">UHCI_OUT_DSCR_ERR_INT_CLR</div> <div style="writing-mode: vertical-rl; transform: rotate(180deg);">UHCI_OUT_EOF_INT_CLR</div> <div style="writing-mode: vertical-rl; transform: rotate(180deg);">UHCI_IN_DSCR_ERR_INT_CLR</div> <div style="writing-mode: vertical-rl; transform: rotate(180deg);">UHCI_OUT_DONE_INT_CLR</div> <div style="writing-mode: vertical-rl; transform: rotate(180deg);">UHCI_IN_ERR_EOF_INT_CLR</div> <div style="writing-mode: vertical-rl; transform: rotate(180deg);">UHCI_IN_SUC_EOF_INT_CLR</div> <div style="writing-mode: vertical-rl; transform: rotate(180deg);">UHCI_IN_DONE_INT_CLR</div> <div style="writing-mode: vertical-rl; transform: rotate(180deg);">UHCI_TX_HUNG_INT_CLR</div> <div style="writing-mode: vertical-rl; transform: rotate(180deg);">UHCI_RX_HUNG_INT_CLR</div> <div style="writing-mode: vertical-rl; transform: rotate(180deg);">UHCI_TX_START_INT_CLR</div> <div style="writing-mode: vertical-rl; transform: rotate(180deg);">UHCI_RX_START_INT_CLR</div> </div>																			
31																	17	16	15	14	13	12	11	10	9	8	7	6	5	4	3	2	1	0	Reset	
0	0	0	0	0	0	0	0	0	0	0	0	0	0	0	0	0	0	0	0	0	0	0	0	0	0	0	0	0	0	0	0	0	0	0	0	0

**UHCI\_SEND\_A\_REG\_Q\_INT\_CLR** Set this bit to clear the [UHCI\\_SEND\\_A\\_REG\\_Q\\_INT](#) interrupt. (WO)

**UHCI\_SEND\_S\_REG\_Q\_INT\_CLR** Set this bit to clear the [UHCI\\_SEND\\_S\\_REG\\_Q\\_INT](#) interrupt. (WO)

**UHCI\_OUT\_TOTAL\_EOF\_INT\_CLR** Set this bit to clear the [UHCI\\_OUT\\_TOTAL\\_EOF\\_INT](#) interrupt. (WO)

**UHCI\_OUTLINK\_EOF\_ERR\_INT\_CLR** Set this bit to clear the [UHCI\\_OUTLINK\\_EOF\\_ERR\\_INT](#) interrupt. (WO)

**UHCI\_IN\_DSCR\_EMPTY\_INT\_CLR** Set this bit to clear the [UHCI\\_IN\\_DSCR\\_EMPTY\\_INT](#) interrupt. (WO)

**UHCI\_OUT\_DSCR\_ERR\_INT\_CLR** Set this bit to clear the [UHCI\\_OUT\\_DSCR\\_ERR\\_INT](#) interrupt. (WO)

**UHCI\_IN\_DSCR\_ERR\_INT\_CLR** Set this bit to clear the [UHCI\\_IN\\_DSCR\\_ERR\\_INT](#) interrupt. (WO)

**UHCI\_OUT\_EOF\_INT\_CLR** Set this bit to clear the [UHCI\\_OUT\\_EOF\\_INT](#) interrupt. (WO)

**UHCI\_OUT\_DONE\_INT\_CLR** Set this bit to clear the [UHCI\\_OUT\\_DONE\\_INT](#) interrupt. (WO)

**UHCI\_IN\_ERR\_EOF\_INT\_CLR** Set this bit to clear the [UHCI\\_IN\\_ERR\\_EOF\\_INT](#) interrupt. (WO)

**UHCI\_IN\_SUC\_EOF\_INT\_CLR** Set this bit to clear the [UHCI\\_IN\\_SUC\\_EOF\\_INT](#) interrupt. (WO)

**UHCI\_IN\_DONE\_INT\_CLR** Set this bit to clear the [UHCI\\_IN\\_DONE\\_INT](#) interrupt. (WO)

**UHCI\_TX\_HUNG\_INT\_CLR** Set this bit to clear the [UHCI\\_TX\\_HUNG\\_INT](#) interrupt. (WO)

**UHCI\_RX\_HUNG\_INT\_CLR** Set this bit to clear the [UHCI\\_RX\\_HUNG\\_INT](#) interrupt. (WO)

**UHCI\_TX\_START\_INT\_CLR** Set this bit to clear the [UHCI\\_TX\\_START\\_INT](#) interrupt. (WO)

**UHCI\_RX\_START\_INT\_CLR** Set this bit to clear the [UHCI\\_RX\\_START\\_INT](#) interrupt. (WO)

## Register 13.32. UHCI\_DMA\_OUT\_STATUS\_REG (0x14)

(reserved)																												UHCI_OUT_EMPTY UHCI_OUT_FULL		
31																											2	1	0	Reset
0 0																										1	0	0		

**UHCI\_OUT\_EMPTY** 1: DMA inlink descriptor's FIFO is empty. (RO)

**UHCI\_OUT\_FULL** 1: DMA outlink descriptor's FIFO is full. (RO)

## Register 13.33. UHCI\_DMA\_OUT\_PUSH\_REG (0x18)

(reserved)															UHCI_OUTFIFO_PUSH				(reserved)				UHCI_OUTFIFO_WDATA				
31														17	16	15				9	8				0	Reset	
0 0 0 0 0 0 0 0 0 0 0 0 0 0 0															0	0	0	0	0	0	0	0	0	0x000			0

**UHCI\_OUTFIFO\_PUSH** Set this bit to push data into DMA FIFO. (R/W)

**UHCI\_OUTFIFO\_WDATA** This is the data that need to be pushed into DMA FIFO. (R/W)

## Register 13.34. UHCI\_DMA\_IN\_POP\_REG (0x20)

(reserved)															UHCI_INFIFO_POP				(reserved)				UHCI_INFIFO_RDATA			
31														17	16	15				12	11				0	Reset
0 0 0 0 0 0 0 0 0 0 0 0 0 0 0															0	0	0	0	0	0	0	0	0x0000			

**UHCI\_INFIFO\_POP** Set this bit to pop data from DMA FIFO. (R/W)

**UHCI\_INFIFO\_RDATA** This register stores the data popping from DMA FIFO. (RO)

Register 13.35. UHCI\_DMA\_OUT\_LINK\_REG (0x24)

UHCI_OUTLINK_PARK				UHCI_OUTLINK_RESTART				UHCI_OUTLINK_START				UHCI_OUTLINK_STOP				(reserved)				UHCI_OUTLINK_ADDR				0							
31	30	29	28	27	26	25	24	23	22	21	20	19	18	17	16	15	14	13	12	11	10	9	8	7	6	5	4	3	2	1	0
0	0	0	0	0	0	0	0	0	0	0	0	0	0x000000														0				

**UHCI\_OUTLINK\_PARK** 1: the outlink descriptor's FSM is in idle state; 0: the outlink descriptor's FSM is working. (RO)

**UHCI\_OUTLINK\_RESTART** Set this bit to restart the outlink descriptor from the last address. (R/W)

**UHCI\_OUTLINK\_START** Set this bit to start a new outlink descriptor. (R/W)

**UHCI\_OUTLINK\_STOP** Set this bit to stop dealing with the outlink descriptor. (R/W)

**UHCI\_OUTLINK\_ADDR** This register stores the least significant 20 bits of the first outlink descriptor's address. (R/W)

Register 13.36. UHCI\_DMA\_IN\_LINK\_REG (0x28)

UHCI_INLINK_PARK				UHCI_INLINK_RESTART				UHCI_INLINK_START				UHCI_INLINK_STOP				(reserved)				UHCI_INLINK_ADDR				0							
31	30	29	28	27	26	25	24	23	22	21	20	19	18	17	16	15	14	13	12	11	10	9	8	7	6	5	4	3	2	1	0
0	0	0	0	0	0	0	0	0	0	0	0	0	0x000000														0				

**UHCI\_INLINK\_PARK** 1: the inlink descriptor's FSM is in idle state; 0: the inlink descriptor's FSM is working. (RO)

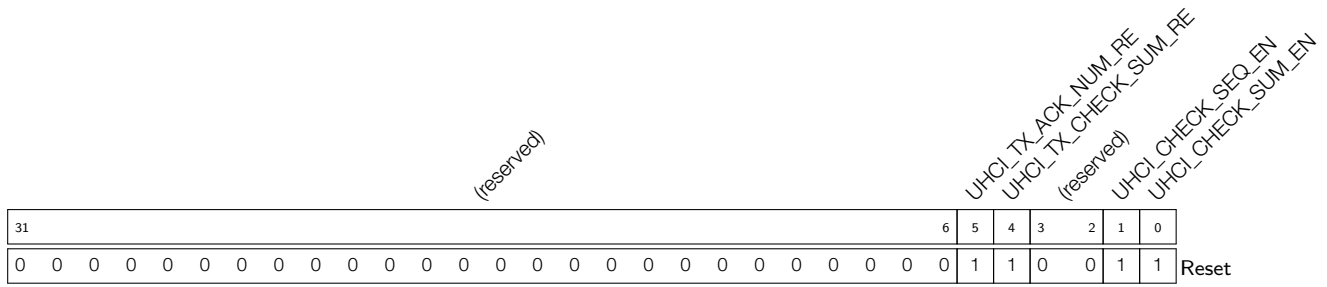
**UHCI\_INLINK\_RESTART** Set this bit to mount new inlink descriptors. (R/W)

**UHCI\_INLINK\_START** Set this bit to start dealing with the inlink descriptors. (R/W)

**UHCI\_INLINK\_STOP** Set this bit to stop dealing with the inlink descriptors. (R/W)

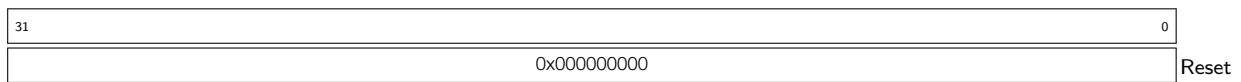
**UHCI\_INLINK\_ADDR** This register stores the 20 least significant bits of the first inlink descriptor's address. (R/W)

**Register 13.37. UHCI\_CONF1\_REG (0x2C)**



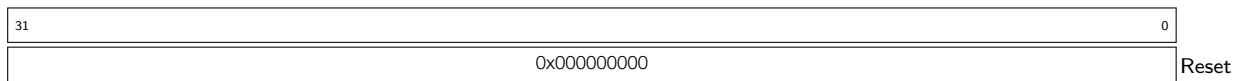
- UHCI\_TX\_ACK\_NUM\_RE** Reserved. Please initialize to 0. (R/W)
- UHCI\_TX\_CHECK\_SUM\_RE** Reserved. Please initialize to 0. (R/W)
- UHCI\_CHECK\_SEQ\_EN** Reserved. Please initialize to 0. (R/W)
- UHCI\_CHECK\_SUM\_EN** Reserved. Please initialize to 0. (R/W)

**Register 13.38. UHCI\_DMA\_OUT\_EOF\_DES\_ADDR\_REG (0x38)**



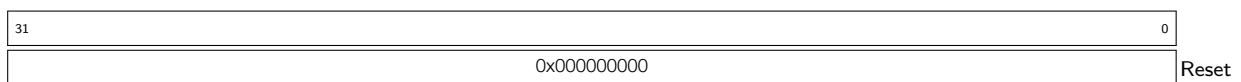
**UHCI\_DMA\_OUT\_EOF\_DES\_ADDR\_REG** This register stores the address of the outlink descriptor when the EOF bit in this descriptor is 1. (RO)

**Register 13.39. UHCI\_DMA\_IN\_SUC\_EOF\_DES\_ADDR\_REG (0x3C)**



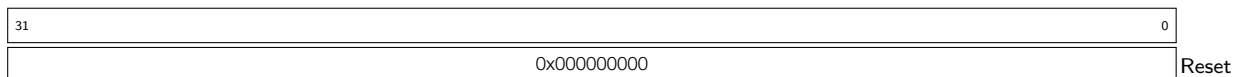
**UHCI\_DMA\_IN\_SUC\_EOF\_DES\_ADDR\_REG** This register stores the address of the inlink descriptor when the EOF bit in this descriptor is 1. (RO)

**Register 13.40. UHCI\_DMA\_IN\_ERR\_EOF\_DES\_ADDR\_REG (0x40)**



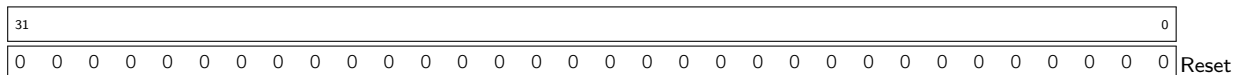
**UHCI\_DMA\_IN\_ERR\_EOF\_DES\_ADDR\_REG** This register stores the address of the inlink descriptor when there are some errors in this descriptor. (RO)

**Register 13.41. UHCI\_DMA\_OUT\_EOF\_BFR\_DES\_ADDR\_REG (0x44)**



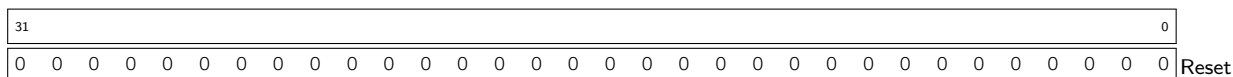
**UHCI\_DMA\_OUT\_EOF\_BFR\_DES\_ADDR\_REG** This register stores the address of the outlink descriptor when there are some errors in this descriptor. (RO)

**Register 13.42. UHCI\_DMA\_IN\_DSCR\_REG (0x4C)**



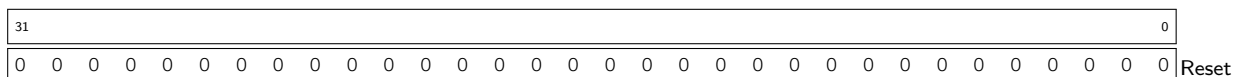
**UHCI\_DMA\_IN\_DSCR\_REG** The address of the current inlink descriptor *x*. (RO)

**Register 13.43. UHCI\_DMA\_IN\_DSCR\_BF0\_REG (0x50)**



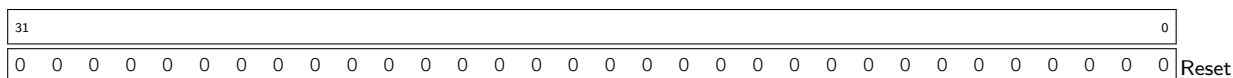
**UHCI\_DMA\_IN\_DSCR\_BF0\_REG** The address of the last inlink descriptor *x-1*. (RO)

**Register 13.44. UHCI\_DMA\_IN\_DSCR\_BF1\_REG (0x54)**



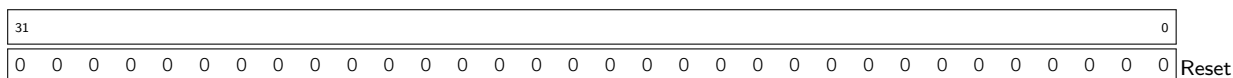
**UHCI\_DMA\_IN\_DSCR\_BF1\_REG** The address of the second-to-last inlink descriptor *x-2*. (RO)

**Register 13.45. UHCI\_DMA\_OUT\_DSCR\_REG (0x58)**



**UHCI\_DMA\_OUT\_DSCR\_REG** The address of the current outlink descriptor *y*. (RO)

**Register 13.46. UHCI\_DMA\_OUT\_DSCR\_BF0\_REG (0x5C)**



**UHCI\_DMA\_OUT\_DSCR\_BF0\_REG** The address of the last outlink descriptor *y-1*. (RO)

**Register 13.47. UHCI\_DMA\_OUT\_DSCR\_BF1\_REG (0x60)**

31																																0	
0 0																																	Reset

**UHCI\_DMA\_OUT\_DSCR\_BF1\_REG** The address of the second-to-last outlink descriptor  $y-2$ . (RO)

**Register 13.48. UHCI\_ESCAPE\_CONF\_REG (0x64)**

31	(reserved)																							8	7	6	5	4	3	2	1	0	Reset
0 0																								0	0	0	1	1	0	0	1	1	

UHCI\_RX\_13\_ESC\_EN  
 UHCI\_RX\_11\_ESC\_EN  
 UHCI\_RX\_DB\_ESC\_EN  
 UHCI\_RX\_C0\_ESC\_EN  
 UHCI\_TX\_13\_ESC\_EN  
 UHCI\_TX\_11\_ESC\_EN  
 UHCI\_TX\_DB\_ESC\_EN  
 UHCI\_TX\_C0\_ESC\_EN

**UHCI\_RX\_13\_ESC\_EN** Set this bit to enable replacing flow control char 0x13, when DMA sends data. (R/W)

**UHCI\_RX\_11\_ESC\_EN** Set this bit to enable replacing flow control char 0x11, when DMA sends data. (R/W)

**UHCI\_RX\_DB\_ESC\_EN** Set this bit to enable replacing 0xdb char, when DMA sends data. (R/W)

**UHCI\_RX\_C0\_ESC\_EN** Set this bit to enable replacing 0xc0 char, when DMA sends data. (R/W)

**UHCI\_TX\_13\_ESC\_EN** Set this bit to enable decoding flow control char 0x13, when DMA receives data. (R/W)

**UHCI\_TX\_11\_ESC\_EN** Set this bit to enable decoding flow control char 0x11, when DMA receives data. (R/W)

**UHCI\_TX\_DB\_ESC\_EN** Set this bit to enable decoding 0xdb char, when DMA receives data. (R/W)

**UHCI\_TX\_C0\_ESC\_EN** Set this bit to enable decoding 0xc0 char, when DMA receives data. (R/W)



**Register 13.49. UHCI\_HUNG\_CONF\_REG (0x68)**

(reserved)								UHCI_RXFIFO_TIMEOUT_ENA				UHCI_RXFIFO_TIMEOUT_SHIFT				UHCI_RXFIFO_TIMEOUT				UHCI_TXFIFO_TIMEOUT_ENA				UHCI_TXFIFO_TIMEOUT_SHIFT				UHCI_TXFIFO_TIMEOUT			
31	24	23	22	20	19	12	11	10	8	7	0	31	24	23	22	20	19	12	11	10	8	7	0								
0	0	0	0	0	0	0	0	0	0	0	0	1	0	0	0	0	0	0	0	0	0	0	0	0x010	0x010	0x010	0x010	0x010	0x010	Reset	

**UHCI\_RXFIFO\_TIMEOUT\_ENA** This is the enable bit for DMA send-data timeout. (R/W)

**UHCI\_RXFIFO\_TIMEOUT\_SHIFT** The tick count is cleared when its value is equal to or greater than (17'd8000»reg\_rxfifo\_timeout\_shift). (R/W)

**UHCI\_RXFIFO\_TIMEOUT** This register stores the timeout value. When DMA takes more time to read data from RAM than what this register indicates, it will produce the UHCI\_RX\_HUNG\_INT interrupt. (R/W)

**UHCI\_TXFIFO\_TIMEOUT\_ENA** The enable bit for Tx FIFO receive-data timeout (R/W)

**UHCI\_TXFIFO\_TIMEOUT\_SHIFT** The tick count is cleared when its value is equal to or greater than (17'd8000»reg\_txfifo\_timeout\_shift). (R/W)

**UHCI\_TXFIFO\_TIMEOUT** This register stores the timeout value. When DMA takes more time to receive data than what this register indicates, it will produce the UHCI\_TX\_HUNG\_INT interrupt. (R/W)

**Register 13.50. UHCI\_ESC\_CONF<sub>n</sub>\_REG (n: 0-3) (0xB0+4\*n)**

(reserved)								UHCI_ESC_SEQ2_CHAR1								UHCI_ESC_SEQ2_CHAR0								UHCI_ESC_SEQ2								
31	24	23	16	15	8	7	0	31	24	23	16	15	8	7	0	31	24	23	16	15	8	7	0	31	24	23	16	15	8	7	0	
0	0	0	0	0	0	0	0	0x0DF	0x0DF	0x0DF	0x0DF	0x0DF	0x0DF	0x0DF	0x0DF	0x0DB	0x0DB	0x0DB	0x0DB	0x0DB	0x0DB	0x0DB	0x0DB	0x013	0x013	0x013	0x013	0x013	0x013	0x013	0x013	Reset

**UHCI\_ESC\_SEQ2\_CHAR1** This register stores the second char used to replace the reg\_esc\_seq2 in data. (R/W)

**UHCI\_ESC\_SEQ2\_CHAR0** This register stores the first char used to replace the reg\_esc\_seq2 in data. (R/W)

**UHCI\_ESC\_SEQ2** This register stores the flow\_control char to turn off the flow\_control. (R/W)

# 14 LED PWM Controller (LEDC)

## 14.1 Introduction

The LED\_PWM controller is primarily designed to control the intensity of LEDs, although it can be used to generate PWM signals for other purposes as well. It has 16 channels which can generate independent waveforms that can be used to drive RGB LED devices. For maximum flexibility, the high-speed as well as the low-speed channels can be driven from one of four high-speed/low-speed timers. The PWM controller also has the ability to automatically increase or decrease the duty cycle gradually, allowing for fades without any processor interference. To increase resolution, the LED\_PWM controller is also able to dither between two values, when a fractional PWM value is configured.

The LED\_PWM controller has eight high-speed and eight low-speed PWM generators. In this document, they will be referred to as  $hsch_n$  and  $lsch_n$ , respectively. These channels can be driven from four timers which will be indicated by  $h\_timer_x$  and  $l\_timer_x$ .

## 14.2 Functional Description

### 14.2.1 Architecture

Figure 14-1 shows the architecture of the LED\_PWM controller. As can be seen in the figure, the LED\_PWM controller contains eight high-speed and eight low-speed channels. There are four high-speed clock modules for the high-speed channels, from which one  $h\_timer_x$  can be selected. There are also four low-speed clock modules for the low-speed channels, from which one  $l\_timer_x$  can be selected.

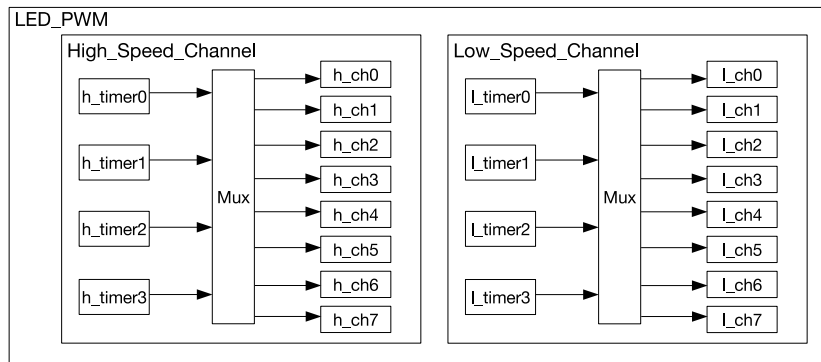


Figure 14-1. LED\_PWM Architecture

Figure 14-2 illustrates a PWM channel with its selected timer; in this instance a high-speed channel and associated high-speed timer.

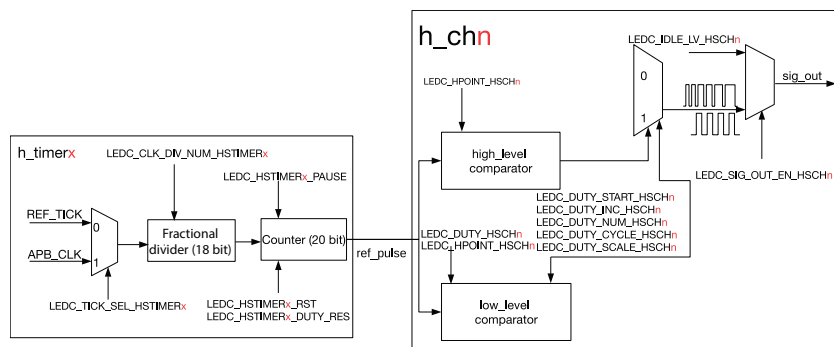


Figure 14-2. LED\_PWM High-speed Channel Diagram

## 14.2.2 Timers

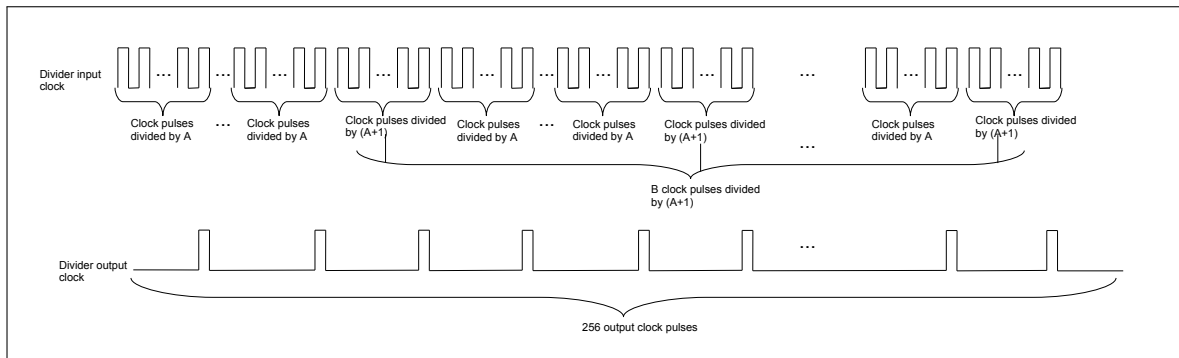


Figure 14-3. LED\_PWM Divider

The clock of each high-speed timer, `LEDC_CLKx`, has two clock sources: `REF_TICK` or `APB_CLK`. For more information on the clock sources, please see Chapter [Reset And Clock](#). The input clock is divided down by a divider first. The division factor is specified by `LEDC_CLK_DIV_NUM_HSTIMERx` which contains a fixed point number: the highest 10 bits represent the integer portion A, while the lowest eight bits contain the fractional portion B. The effective division factor `LEDC_CLK_DIVx` is as follows:

$$LEDC\_CLK\_DIVx = A + \frac{B}{256}$$

The division factor ranges from 1 ~ 1023.

When the fractional part B is not 0, the input and output clock of the divider is shown as in figure 14-3. Among the 256 output clocks, B of them are divided by (A+1), whereas the remaining (256-B) are divided by A. Output clocks divided by (A+1) are evenly distributed in the total 256 output clocks.

The output clock of the divider is the base clock for the counter which will count up to the value specified in `LEDC_HSTIMERx_DUTY_RES`. An overflow interrupt will be generated once the counting value reaches  $2^{LEDC\_HSTIMERx\_DUTY\_RES} - 1$ , at which point the counter restarts counting from 0. It is also possible to reset, suspend, and read the values of the counter by software.

The output signal of the timer is the 20-bit value generated by the counter. The cycle period of this signal defines the frequency of the signals of any PWM channels connected to this timer.

The frequency of a PWM generator output signal, `sig_outn`, depends on both the division factor of the divider, as well as the range of the counter:

$$f_{sig\_outn} = \frac{f_{LEDC\_CLKx}}{LEDC\_CLK\_DIVx \cdot 2^{LEDC\_HSTIMERx\_DUTY\_RES}}$$

Table 14-1 lists the commonly-used frequencies and their corresponding resolutions.

Table 14-1. Commonly-used Frequencies and Resolutions

LEDC Clock Source	LEDC Output (PWM) Frequency	Highest Resolution
APB_CLK (80 MHz)	1 kHz	1/65536 (16 bit)
APB_CLK (80 MHz)	5 kHz	1/8192 (13 bit)
APB_CLK (80 MHz)	10 kHz	1/4096 (12 bit)
RTC8M_CLK (8 MHz)	1 kHz	1/4096 (12 bit)
RTC8M_CLK (8 MHz)	8 kHz	1/512 (9 bit)

REF_TICK (1 MHz)	1 kHz	1/512 (9 bit)
------------------	-------	---------------

The low-speed timers  $l\_timer_x$  on the low-speed channel differ from the high-speed timers  $h\_timer_x$  in two aspects:

1. Where the high-speed timer clock source can be clocked from REF\_TICK or APB\_CLK, the low-speed timers are sourced from either REF\_TICK or SLOW\_CLOCK. The SLOW\_CLOCK source can be either APB\_CLK (80 MHz) or 8 MHz, and can be selected using LEDC\_APB\_CLK\_SEL.
2. The high-speed counter and divider are glitch-free, which means that if the software modifies the maximum counter or divisor value, the update will come into effect after the next overflow interrupt. In contrast, the low-speed counter and divider will update these values only when LEDC\_LSTIMER $_x$ \_PARA\_UP is set.

### 14.2.3 Channels

A channel takes the 20-bit value from the counter of the selected high-speed timer and compares it to a set of two values in order to set the channel output. The first value it is compared to is the content of LEDC\_HPOINT\_HSCH $_n$ ; if these two match, the output will be latched high. The second value is the sum of LEDC\_HPOINT\_HSCH $_n$  and LEDC\_DUTY\_HSCH $_n$ [24..4]. When this value is reached, the output is latched low. By using these two values, the relative phase and the duty cycle of the PWM output can be set. Figure 14-4 illustrates this.

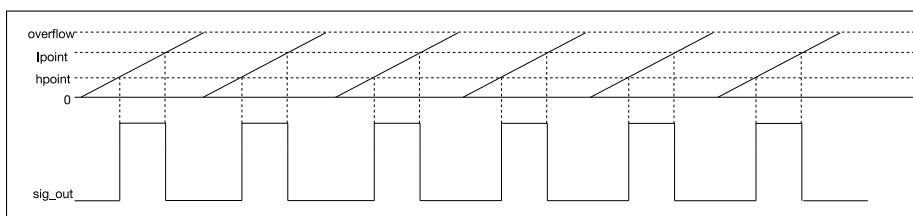


Figure 14-4. LED PWM Output Signal Diagram

LEDC\_DUTY\_HSCH $_n$  is a fixed-point register with four fractional bits. As mentioned before, when LEDC\_DUTY\_HSCH $_n$ [24..4] is used in the PWM calculation directly, LEDC\_DUTY\_HSCH $_n$ [3..0] can be used to dither the output. If this value is non-zero, with a statistical chance of LEDC\_DUTY\_HSCH $_n$ [3..0]/16, the actual PWM pulse will be one cycle longer. This effectively increases the resolution of the PWM generator to 25 bits, but at the cost of a slight jitter in the duty cycle.

The channels also have the ability to automatically fade from one duty cycle value to another. This feature is enabled by setting LEDC\_DUTY\_START\_HSCH $_n$ . When this bit is set, the PWM controller will automatically increment or decrement the value in LEDC\_DUTY\_HSCH $_n$ , depending on whether the bit LEDC\_DUTY\_INC\_HSCH $_n$  is set or cleared, respectively. The speed the duty cycle changes is defined as such: every time the LEDC\_DUTY\_CYCLE\_HSCH $_n$  cycles, the content of LEDC\_DUTY\_SCALE\_HSCH $_n$  is added to or subtracted from LEDC\_DUTY\_HSCH $_n$ [24..4]. The length of the fade can be limited by setting LEDC\_DUTY\_NUM\_HSCH $_n$ : the fade will only last that number of cycles before finishing. A finished fade also generates an interrupt.

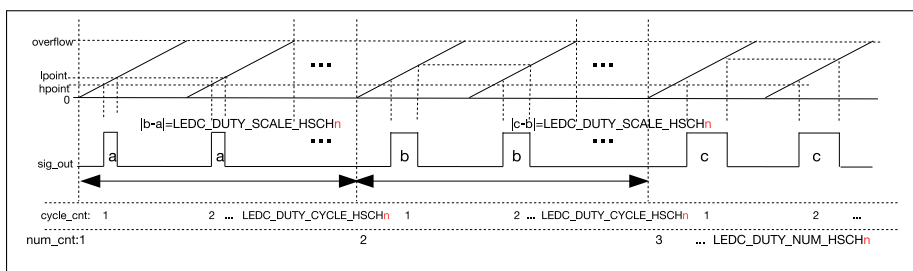


Figure 14-5. Output Signal Diagram of Fading Duty Cycle

Figure 14-5 is an illustration of this. In this configuration, LEDC\_DUTY\_NUM\_HSCH $n$ \_R increases by LEDC\_DUTY\_SCALE\_HSCH $n$  for every LEDC\_DUTY\_CYCLE\_HSCH $n$  clock cycles, which is reflected in the duty cycle of the output signal.

### Notes

- When LEDC is in fade mode, configure the second fade only after LEDC\_DUTY\_CHNG\_END\_HSCH $n$  or LEDC\_DUTY\_CHNG\_END\_LSCH $n$  interrupt is generated.
- When LEDC is in decremental fade mode and LEDC\_DUTY\_HSCH $n$  is  $2^{LEDC\_HSTIMERx\_DUTY\_RES}$ , LEDC\_DUTY\_SCALE\_HSCH $n$  cannot be set to 1. When LEDC is in decremental fade mode and LEDC\_DUTY\_LSCH $n$  is  $2^{LEDC\_LSTIMERx\_DUTY\_RES}$ , LEDC\_DUTY\_SCALE\_LSCH $n$  cannot be set to 1.

### 14.2.4 Interrupts

- LEDC\_DUTY\_CHNG\_END\_LSCH $n$ \_INT: Triggered when a fade on a low-speed channel has finished.
- LEDC\_DUTY\_CHNG\_END\_HSCH $n$ \_INT: Triggered when a fade on a high-speed channel has finished.
- LEDC\_HS\_TIMER $x$ \_OVF\_INT: Triggered when a high-speed timer has reached its maximum counter value.
- LEDC\_LS\_TIMER $x$ \_OVF\_INT: Triggered when a low-speed timer has reached its maximum counter value.

## 14.3 Register Summary

Name	Description	Address	Access
<b>Configuration registers</b>			
LEDC_CONF_REG	Global ledc configuration register	0x3FF59190	R/W
LEDC_HSCH0_CONF0_REG	Configuration register 0 for high-speed channel 0	0x3FF59000	R/W
LEDC_HSCH1_CONF0_REG	Configuration register 0 for high-speed channel 1	0x3FF59014	R/W
LEDC_HSCH2_CONF0_REG	Configuration register 0 for high-speed channel 2	0x3FF59028	R/W
LEDC_HSCH3_CONF0_REG	Configuration register 0 for high-speed channel 3	0x3FF5903C	R/W
LEDC_HSCH4_CONF0_REG	Configuration register 0 for high-speed channel 4	0x3FF59050	R/W
LEDC_HSCH5_CONF0_REG	Configuration register 0 for high-speed channel 5	0x3FF59064	R/W
LEDC_HSCH6_CONF0_REG	Configuration register 0 for high-speed channel 6	0x3FF59078	R/W
LEDC_HSCH7_CONF0_REG	Configuration register 0 for high-speed channel 7	0x3FF5908C	R/W
LEDC_HSCH0_CONF1_REG	Configuration register 1 for high-speed channel 0	0x3FF5900C	R/W
LEDC_HSCH1_CONF1_REG	Configuration register 1 for high-speed channel 1	0x3FF59020	R/W
LEDC_HSCH2_CONF1_REG	Configuration register 1 for high-speed channel 2	0x3FF59034	R/W
LEDC_HSCH3_CONF1_REG	Configuration register 1 for high-speed channel 3	0x3FF59048	R/W
LEDC_HSCH4_CONF1_REG	Configuration register 1 for high-speed channel 4	0x3FF5905C	R/W
LEDC_HSCH5_CONF1_REG	Configuration register 1 for high-speed channel 5	0x3FF59070	R/W
LEDC_HSCH6_CONF1_REG	Configuration register 1 for high-speed channel 6	0x3FF59084	R/W
LEDC_HSCH7_CONF1_REG	Configuration register 1 for high-speed channel 7	0x3FF59098	R/W
LEDC_LSCH0_CONF0_REG	Configuration register 0 for low-speed channel 0	0x3FF590A0	R/W
LEDC_LSCH1_CONF0_REG	Configuration register 0 for low-speed channel 1	0x3FF590B4	R/W
LEDC_LSCH2_CONF0_REG	Configuration register 0 for low-speed channel 2	0x3FF590C8	R/W
LEDC_LSCH3_CONF0_REG	Configuration register 0 for low-speed channel 3	0x3FF590DC	R/W
LEDC_LSCH4_CONF0_REG	Configuration register 0 for low-speed channel 4	0x3FF590F0	R/W
LEDC_LSCH5_CONF0_REG	Configuration register 0 for low-speed channel 5	0x3FF59104	R/W
LEDC_LSCH6_CONF0_REG	Configuration register 0 for low-speed channel 6	0x3FF59118	R/W

Name	Description	Address	Access
LEDC_LSCH7_CONF0_REG	Configuration register 0 for low-speed channel 7	0x3FF5912C	R/W
LEDC_LSCH0_CONF1_REG	Configuration register 1 for low-speed channel 0	0x3FF590AC	R/W
LEDC_LSCH1_CONF1_REG	Configuration register 1 for low-speed channel 1	0x3FF590C0	R/W
LEDC_LSCH2_CONF1_REG	Configuration register 1 for low-speed channel 2	0x3FF590D4	R/W
LEDC_LSCH3_CONF1_REG	Configuration register 1 for low-speed channel 3	0x3FF590E8	R/W
LEDC_LSCH4_CONF1_REG	Configuration register 1 for low-speed channel 4	0x3FF590FC	R/W
LEDC_LSCH5_CONF1_REG	Configuration register 1 for low-speed channel 5	0x3FF59110	R/W
LEDC_LSCH6_CONF1_REG	Configuration register 1 for low-speed channel 6	0x3FF59124	R/W
LEDC_LSCH7_CONF1_REG	Configuration register 1 for low-speed channel 7	0x3FF59138	R/W
<b>Duty-cycle registers</b>			
LEDC_HSCH0_DUTY_REG	Initial duty cycle for high-speed channel 0	0x3FF59008	R/W
LEDC_HSCH1_DUTY_REG	Initial duty cycle for high-speed channel 1	0x3FF5901C	R/W
LEDC_HSCH2_DUTY_REG	Initial duty cycle for high-speed channel 2	0x3FF59030	R/W
LEDC_HSCH3_DUTY_REG	Initial duty cycle for high-speed channel 3	0x3FF59044	R/W
LEDC_HSCH4_DUTY_REG	Initial duty cycle for high-speed channel 4	0x3FF59058	R/W
LEDC_HSCH5_DUTY_REG	Initial duty cycle for high-speed channel 5	0x3FF5906C	R/W
LEDC_HSCH6_DUTY_REG	Initial duty cycle for high-speed channel 6	0x3FF59080	R/W
LEDC_HSCH7_DUTY_REG	Initial duty cycle for high-speed channel 7	0x3FF59094	R/W
LEDC_HSCH0_DUTY_R_REG	Current duty cycle for high-speed channel 0	0x3FF59010	RO
LEDC_HSCH1_DUTY_R_REG	Current duty cycle for high-speed channel 1	0x3FF59024	RO
LEDC_HSCH2_DUTY_R_REG	Current duty cycle for high-speed channel 2	0x3FF59038	RO
LEDC_HSCH3_DUTY_R_REG	Current duty cycle for high-speed channel 3	0x3FF5904C	RO
LEDC_HSCH4_DUTY_R_REG	Current duty cycle for high-speed channel 4	0x3FF59060	RO
LEDC_HSCH5_DUTY_R_REG	Current duty cycle for high-speed channel 5	0x3FF59074	RO
LEDC_HSCH6_DUTY_R_REG	Current duty cycle for high-speed channel 6	0x3FF59088	RO
LEDC_HSCH7_DUTY_R_REG	Current duty cycle for high-speed channel 7	0x3FF5909C	RO
LEDC_LSCH0_DUTY_REG	Initial duty cycle for low-speed channel 0	0x3FF590A8	R/W
LEDC_LSCH1_DUTY_REG	Initial duty cycle for low-speed channel 1	0x3FF590BC	R/W
LEDC_LSCH2_DUTY_REG	Initial duty cycle for low-speed channel 2	0x3FF590D0	R/W
LEDC_LSCH3_DUTY_REG	Initial duty cycle for low-speed channel 3	0x3FF590E4	R/W
LEDC_LSCH4_DUTY_REG	Initial duty cycle for low-speed channel 4	0x3FF590F8	R/W
LEDC_LSCH5_DUTY_REG	Initial duty cycle for low-speed channel 5	0x3FF5910C	R/W
LEDC_LSCH6_DUTY_REG	Initial duty cycle for low-speed channel 6	0x3FF59120	R/W
LEDC_LSCH7_DUTY_REG	Initial duty cycle for low-speed channel 7	0x3FF59134	R/W
LEDC_LSCH0_DUTY_R_REG	Current duty cycle for low-speed channel 0	0x3FF590B0	RO
LEDC_LSCH1_DUTY_R_REG	Current duty cycle for low-speed channel 1	0x3FF590C4	RO
LEDC_LSCH2_DUTY_R_REG	Current duty cycle for low-speed channel 2	0x3FF590D8	RO
LEDC_LSCH3_DUTY_R_REG	Current duty cycle for low-speed channel 3	0x3FF590EC	RO
LEDC_LSCH4_DUTY_R_REG	Current duty cycle for low-speed channel 4	0x3FF59100	RO
LEDC_LSCH5_DUTY_R_REG	Current duty cycle for low-speed channel 5	0x3FF59114	RO
LEDC_LSCH6_DUTY_R_REG	Current duty cycle for low-speed channel 6	0x3FF59128	RO
LEDC_LSCH7_DUTY_R_REG	Current duty cycle for low-speed channel 7	0x3FF5913C	RO
<b>Timer registers</b>			

Name	Description	Address	Access
<a href="#">LEDC_HSTIMER0_CONF_REG</a>	High-speed timer 0 configuration	0x3FF59140	R/W
<a href="#">LEDC_HSTIMER1_CONF_REG</a>	High-speed timer 1 configuration	0x3FF59148	R/W
<a href="#">LEDC_HSTIMER2_CONF_REG</a>	High-speed timer 2 configuration	0x3FF59150	R/W
<a href="#">LEDC_HSTIMER3_CONF_REG</a>	High-speed timer 3 configuration	0x3FF59158	R/W
<a href="#">LEDC_HSTIMER0_VALUE_REG</a>	High-speed timer 0 current counter value	0x3FF59144	RO
<a href="#">LEDC_HSTIMER1_VALUE_REG</a>	High-speed timer 1 current counter value	0x3FF5914C	RO
<a href="#">LEDC_HSTIMER2_VALUE_REG</a>	High-speed timer 2 current counter value	0x3FF59154	RO
<a href="#">LEDC_HSTIMER3_VALUE_REG</a>	High-speed timer 3 current counter value	0x3FF5915C	RO
<a href="#">LEDC_LSTIMER0_CONF_REG</a>	Low-speed timer 0 configuration	0x3FF59160	R/W
<a href="#">LEDC_LSTIMER1_CONF_REG</a>	Low-speed timer 1 configuration	0x3FF59168	R/W
<a href="#">LEDC_LSTIMER2_CONF_REG</a>	Low-speed timer 2 configuration	0x3FF59170	R/W
<a href="#">LEDC_LSTIMER3_CONF_REG</a>	Low-speed timer 3 configuration	0x3FF59178	R/W
<a href="#">LEDC_LSTIMER0_VALUE_REG</a>	Low-speed timer 0 current counter value	0x3FF59164	RO
<a href="#">LEDC_LSTIMER1_VALUE_REG</a>	Low-speed timer 1 current counter value	0x3FF5916C	RO
<a href="#">LEDC_LSTIMER2_VALUE_REG</a>	Low-speed timer 2 current counter value	0x3FF59174	RO
<a href="#">LEDC_LSTIMER3_VALUE_REG</a>	Low-speed timer 3 current counter value	0x3FF5917C	RO
<b>Interrupt registers</b>			
<a href="#">LEDC_INT_RAW_REG</a>	Raw interrupt status	0x3FF59180	RO
<a href="#">LEDC_INT_ST_REG</a>	Masked interrupt status	0x3FF59184	RO
<a href="#">LEDC_INT_ENA_REG</a>	Interrupt enable bits	0x3FF59188	R/W
<a href="#">LEDC_INT_CLR_REG</a>	Interrupt clear bits	0x3FF5918C	WO



## 14.4 Registers

Register 14.1. LEDC\_HSCH $n$ \_CONF0\_REG ( $n$ : 0-7) (0x1C+0x10\* $n$ )

(reserved)				LEDC_IDLE_LV_HSCH $n$ LEDC_SIG_OUT_EN_HSCH $n$ LEDC_TIMER_SEL_HSCH $n$					
31	4	3	2	1	0				
0x00000000						0	0	0	Reset

**LEDC\_IDLE\_LV\_HSCH $n$**  This bit is used to control the output value when high-speed channel  $n$  is inactive. (R/W)

**LEDC\_SIG\_OUT\_EN\_HSCH $n$**  This is the output enable control bit for high-speed channel  $n$ . (R/W)

**LEDC\_TIMER\_SEL\_HSCH $n$**  There are four high-speed timers. These two bits are used to select one of them for high-speed channel  $n$ : (R/W)

- 0: select hstimer0;
- 1: select hstimer1;
- 2: select hstimer2;
- 3: select hstimer3.

Register 14.2. LEDC\_HSCH $n$ \_HPOINT\_REG ( $n$ : 0-7) (0x20+0x10\* $n$ )

(reserved)		LEDC_HPOINT_HSCH $n$		
31	20	19	0	
0x0000		0x000000		Reset

**LEDC\_HPOINT\_HSCH $n$**  The output value changes to high when htimer $x$ ( $x$ =[0,3]), selected by high-speed channel  $n$ , has reached LEDC\_HPOINT\_HSCH $n$ [19:0]. (R/W)

**Register 14.3. LEDC\_HSCH<sub>n</sub>\_DUTY\_REG (*n*: 0-7) (0x24+0x10\**n*)**

(reserved)		LEDC_DUTY_HSCH <sub>n</sub>	
31	25	24	0
0x00		0x0000000	
			Reset

**LEDC\_DUTY\_HSCH<sub>n</sub>** The register is used to control output duty. When hstimerx(x=[0,3]), selected by high-speed channel *n*, has reached LEDC\_LPOINT\_HSCH<sub>n</sub>, the output signal changes to low. (R/W)

LEDC\_LPOINT\_HSCH<sub>n</sub>=LEDC\_LPOINT\_HSCH<sub>n</sub>[19:0]+LEDC\_DUTY\_HSCH<sub>n</sub>[24:4] (1)

LEDC\_LPOINT\_HSCH<sub>n</sub>=LEDC\_LPOINT\_HSCH<sub>n</sub>[19:0]+LEDC\_DUTY\_HSCH<sub>n</sub>[24:4] +1) (2)

See the [Functional Description](#) for more information on when (1) or (2) is chosen.

**Register 14.4. LEDC\_HSCH<sub>n</sub>\_CONF1\_REG (*n*: 0-7) (0x28+0x10\**n*)**

LEDC_DUTY_START_HSCH <sub>n</sub> LEDC_DUTY_INC_HSCH <sub>n</sub>		LEDC_DUTY_NUM_HSCH <sub>n</sub>		LEDC_DUTY_CYCLE_HSCH <sub>n</sub>		LEDC_DUTY_SCALE_HSCH <sub>n</sub>	
31	30	29	20	19	10	9	0
0	1	0x000		0x000		0x000	
							Reset

**LEDC\_DUTY\_START\_HSCH<sub>n</sub>** When LEDC\_DUTY\_NUM\_HSCH<sub>n</sub>, LEDC\_DUTY\_CYCLE\_HSCH<sub>n</sub> and LEDC\_DUTY\_SCALE\_HSCH<sub>n</sub> has been configured, these register will not take effect until LEDC\_DUTY\_START\_HSCH<sub>n</sub> is set. This bit is automatically cleared by hardware. (R/W)

**LEDC\_DUTY\_INC\_HSCH<sub>n</sub>** This register is used to increase or decrease the duty of output signal for high-speed channel *n*. (R/W)

**LEDC\_DUTY\_NUM\_HSCH<sub>n</sub>** This register is used to control the number of times the duty cycle is increased or decreased for high-speed channel *n*. (R/W)

**LEDC\_DUTY\_CYCLE\_HSCH<sub>n</sub>** This register is used to increase or decrease the duty cycle every time LEDC\_DUTY\_CYCLE\_HSCH<sub>n</sub> cycles for high-speed channel *n*. (R/W)

**LEDC\_DUTY\_SCALE\_HSCH<sub>n</sub>** This register is used to increase or decrease the step scale for high-speed channel *n*. (R/W)

Register 14.5. LEDC\_HSCH $n$ \_DUTY\_R\_REG ( $n$ : 0-7) (0x2C+0x10\* $n$ )

(reserved)		LEDC_DUTY_HSCH $n$ _R	
31	25	24	0
0x00		0x0000000	
			Reset

**LEDC\_DUTY\_HSCH $n$ \_R** This register represents the current duty cycle of the output signal for high-speed channel  $n$ . (RO)

Register 14.6. LEDC\_LSCH $n$ \_CONF0\_REG ( $n$ : 0-7) (0xBC+0x10\* $n$ )

(reserved)					LEDC_PARA_UP_LSCH $n$ LEDC_IDLE_LV_LSCH $n$ LEDC_SIG_OUT_EN_LSCH $n$ LEDC_TIMER_SEL_LSCH $n$					
31					5	4	3	2	1	0
0x0000000					0	0	0	0	0	0
										Reset

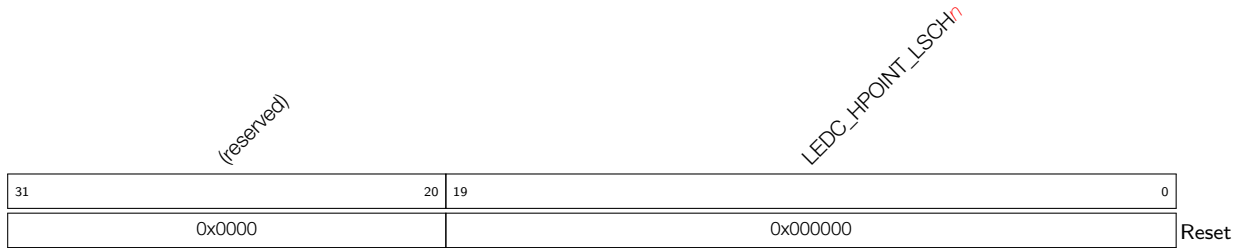
**LEDC\_PARA\_UP\_LSCH $n$**  This bit is used to update register LEDC\_LSCH $n$ \_HPOINT and LEDC\_LSCH $n$ \_DUTY for low-speed channel  $n$ . (R/W)

**LEDC\_IDLE\_LV\_LSCH $n$**  This bit is used to control the output value, when low-speed channel  $n$  is inactive. (R/W)

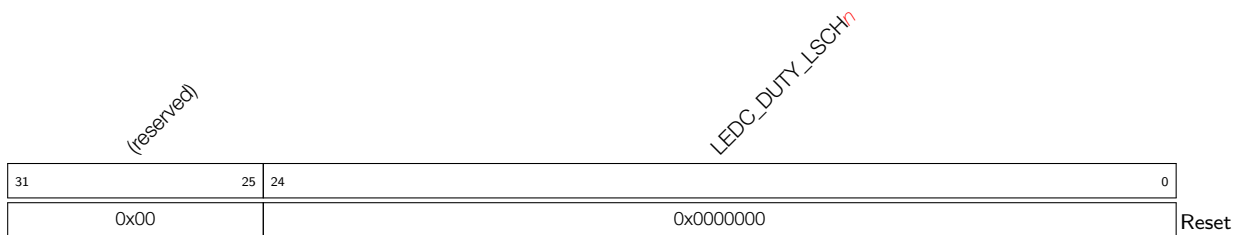
**LEDC\_SIG\_OUT\_EN\_LSCH $n$**  This is the output enable control bit for low-speed channel  $n$ . (R/W)

**LEDC\_TIMER\_SEL\_LSCH $n$**  There are four low-speed timers, the two bits are used to select one of them for low-speed channel  $n$ . (R/W)

- 0: select Istimer0;
- 1: select Istimer1;
- 2: select Istimer2;
- 3: select Istimer3.

**Register 14.7. LEDC\_LSCH $n$ \_HPOINT\_REG ( $n$ : 0-7) (0xC0+0x10\* $n$ )**

**LEDC\_HPOINT\_LSCH $n$**  The output value changes to high when Istimer $x$ ( $x$ =[0,3]), selected by low-speed channel  $n$ , has reached LEDC\_HPOINT\_LSCH $n$ [19:0]. (R/W)

**Register 14.8. LEDC\_LSCH $n$ \_DUTY\_REG ( $n$ : 0-7) (0xC4+0x10\* $n$ )**

**LEDC\_DUTY\_LSCH $n$**  The register is used to control output duty. When Istimer $x$ ( $x$ =[0,3]), chosen by low-speed channel  $n$ , has reached LEDC\_LPOINT\_LSCH $n$ , the output signal changes to low. (R/W)

LEDC\_LPOINT\_LSCH $n$ =(LEDC\_HPOINT\_LSCH $n$ [19:0]+LEDC\_DUTY\_LSCH $n$ [24:4]) (1)

LEDC\_LPOINT\_LSCH $n$ =(LEDC\_HPOINT\_LSCH $n$ [19:0]+LEDC\_DUTY\_LSCH $n$ [24:4] +1) (2)

See the [Functional Description](#) for more information on when (1) or (2) is chosen.

Register 14.9. LEDC\_LSCH $n$ \_CONF1\_REG ( $n$ : 0-7) (0xC8+0x10\* $n$ )

		LEDC_DUTY_START_LSCH $n$ LEDC_DUTY_INC_LSCH $n$																				LEDC_DUTY_NUM_LSCH $n$																				LEDC_DUTY_CYCLE_LSCH $n$																				LEDC_DUTY_SCALE_LSCH $n$																			
31	30																			20	19																			10	9																			0																					
0	1	0x000																		0x000																		0x000																		Reset																									

**LEDC\_DUTY\_START\_LSCH $n$**  When LEDC\_DUTY\_NUM\_HSCH $n$ , LEDC\_DUTY\_CYCLE\_HSCH $n$  and LEDC\_DUTY\_SCALE\_HSCH $n$  have been configured, these settings will not take effect until set LEDC\_DUTY\_START\_HSCH $n$ . This bit is automatically cleared by hardware. (R/W)

**LEDC\_DUTY\_INC\_LSCH $n$**  This register is used to increase or decrease the duty of output signal for low-speed channel  $n$ . (R/W)

**LEDC\_DUTY\_NUM\_LSCH $n$**  This register is used to control the number of times the duty cycle is increased or decreased for low-speed channel  $n$ . (R/W)

**LEDC\_DUTY\_CYCLE\_LSCH $n$**  This register is used to increase or decrease the duty every LEDC\_DUTY\_CYCLE\_LSCH $n$  cycles for low-speed channel  $n$ . (R/W)

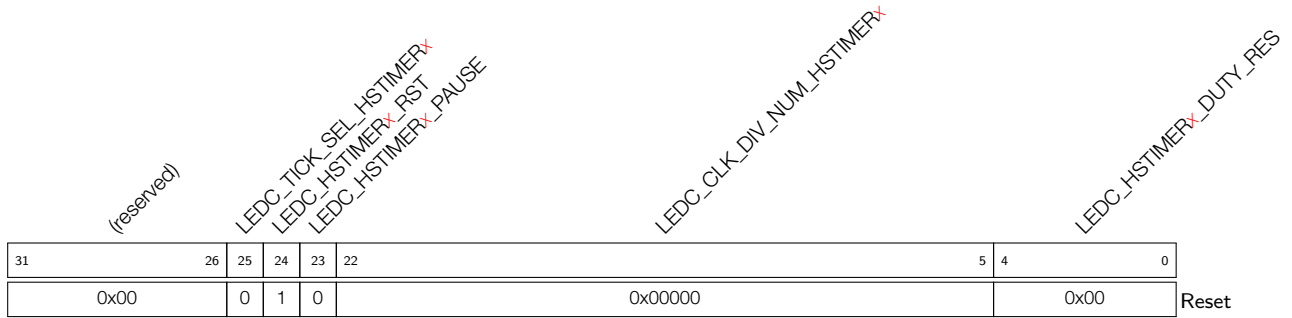
**LEDC\_DUTY\_SCALE\_LSCH $n$**  This register is used to increase or decrease the step scale for low-speed channel  $n$ . (R/W)

Register 14.10. LEDC\_LSCH $n$ \_DUTY\_R\_REG ( $n$ : 0-7) (0xCC+0x10\* $n$ )

		(reserved)																							LEDC_DUTY_LSCH $n$ _R																								
31																							25	24																					0				
0x00				0x0000000																							Reset																						

**LEDC\_DUTY\_LSCH $n$ \_R** This register represents the current duty of the output signal for low-speed channel  $n$ . (RO)

**Register 14.11. LEDC\_HSTIMER<sub>x</sub>\_CONF\_REG (x: 0-3) (0x140+8\*x)**



**LEDC\_TICK\_SEL\_HSTIMER<sub>x</sub>** This bit is used to select APB\_CLK or REF\_TICK for high-speed timer <sub>x</sub>. (R/W)  
 1: APB\_CLK;  
 0: REF\_TICK.

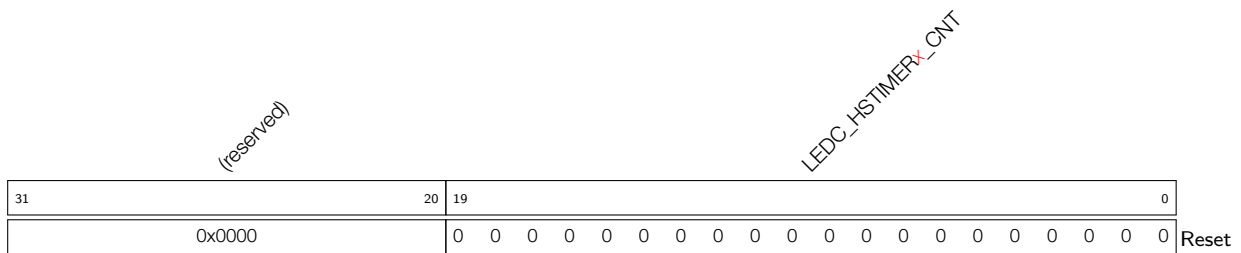
**LEDC\_HSTIMER<sub>x</sub>\_RST** This bit is used to reset high-speed timer <sub>x</sub>. The counter value will be 'zero' after reset. (R/W)

**LEDC\_HSTIMER<sub>x</sub>\_PAUSE** This bit is used to suspend the counter in high-speed timer <sub>x</sub>. (R/W)

**LEDC\_CLK\_DIV\_NUM\_HSTIMER<sub>x</sub>** This register is used to configure the division factor for the divider in high-speed timer <sub>x</sub>. The least significant eight bits represent the fractional part. (R/W)

**LEDC\_HSTIMER<sub>x</sub>\_DUTY\_RES** This register is used to control the range of the counter in high-speed timer <sub>x</sub>. The counter range is [0, 2<sup>LEDC\_HSTIMER<sub>x</sub>\_DUTY\_RES</sup>], the maximum bit width for counter is 20. (R/W)

**Register 14.12. LEDC\_HSTIMER<sub>x</sub>\_VALUE\_REG (x: 0-3) (0x144+8\*x)**



**LEDC\_HSTIMER<sub>x</sub>\_CNT** Software can read this register to get the current counter value of high-speed timer <sub>x</sub>. (RO)

Register 14.13. LEDC\_LSTIMER<sub>x</sub>\_CONF\_REG (x: 0-3) (0x160+8\*x)

(reserved)		LEDC_LSTIMER <sub>x</sub> _PARA_UP LEDC_TICK_SEL_LSTIMER <sub>x</sub> LEDC_LSTIMER <sub>x</sub> _RST LEDC_LSTIMER <sub>x</sub> _PAUSE					LEDC_CLK_DIV_NUM_LSTIMER <sub>x</sub>								LEDC_LSTIMER <sub>x</sub> _DUTY_RES					
31	27	26	25	24	23	22									5	4				
0x00		0	0	1	0	0x00000								0x00				Reset		

**LEDC\_LSTIMER<sub>x</sub>\_PARA\_UP** Set this bit to update LEDC\_CLK\_DIV\_NUM\_LSTIMER<sub>x</sub> and LEDC\_LSTIMER<sub>x</sub>\_DUTY\_RES. (R/W)

**LEDC\_TICK\_SEL\_LSTIMER<sub>x</sub>** This bit is used to select SLOW\_CLK or REF\_TICK for low-speed timer *x*. (R/W)

1: SLOW\_CLK;

0: REF\_TICK.

**LEDC\_LSTIMER<sub>x</sub>\_RST** This bit is used to reset low-speed timer *x*. The counter will show 0 after reset. (R/W)

**LEDC\_LSTIMER<sub>x</sub>\_PAUSE** This bit is used to suspend the counter in low-speed timer *x*. (R/W)

**LEDC\_CLK\_DIV\_NUM\_LSTIMER<sub>x</sub>** This register is used to configure the division factor for the divider in low-speed timer *x*. The least significant eight bits represent the fractional part. (R/W)

**LEDC\_LSTIMER<sub>x</sub>\_DUTY\_RES** This register is used to control the range of the counter in low-speed timer *x*. The counter range is  $[0, 2^{LEDC\_LSTIMER\_DUTY\_RES}]$ , the max bit width for counter is 20. (R/W)

Register 14.14. LEDC\_LSTIMER<sub>x</sub>\_VALUE\_REG (x: 0-3) (0x164+8\*x)

(reserved)																LEDC_LSTIMER <sub>x</sub> _CNT																					
31																				20	19																0
0x0000																0 0															Reset						

**LEDC\_LSTIMER<sub>x</sub>\_CNT** Software can read this register to get the current counter value of low-speed timer *x*. (RO)

**Register 14.15. LEDC\_INT\_RAW\_REG (0x0180)**

(reserved)								LEDC_DUTY_CHNG_END_LSCH7_INT_RAW LEDC_DUTY_CHNG_END_LSCH6_INT_RAW LEDC_DUTY_CHNG_END_LSCH5_INT_RAW LEDC_DUTY_CHNG_END_LSCH4_INT_RAW LEDC_DUTY_CHNG_END_LSCH3_INT_RAW LEDC_DUTY_CHNG_END_LSCH2_INT_RAW LEDC_DUTY_CHNG_END_LSCH1_INT_RAW LEDC_DUTY_CHNG_END_HSCH0_INT_RAW LEDC_DUTY_CHNG_END_HSCH7_INT_RAW LEDC_DUTY_CHNG_END_HSCH6_INT_RAW LEDC_DUTY_CHNG_END_HSCH5_INT_RAW LEDC_DUTY_CHNG_END_HSCH4_INT_RAW LEDC_DUTY_CHNG_END_HSCH3_INT_RAW LEDC_DUTY_CHNG_END_HSCH2_INT_RAW LEDC_DUTY_CHNG_END_HSCH1_INT_RAW LEDC_LSTIMER3_OVF_INT_RAW LEDC_LSTIMER2_OVF_INT_RAW LEDC_LSTIMER1_OVF_INT_RAW LEDC_HSTIMER3_OVF_INT_RAW LEDC_HSTIMER2_OVF_INT_RAW LEDC_HSTIMER1_OVF_INT_RAW LEDC_HSTIMER0_OVF_INT_RAW																							
31	24	23	22	21	20	19	18	17	16	15	14	13	12	11	10	9	8	7	6	5	4	3	2	1	0	Reset					
0	0	0	0	0	0	0	0	0	0	0	0	0	0	0	0	0	0	0	0	0	0	0	0	0	0	0	0	0			

**LEDC\_DUTY\_CHNG\_END\_LSCH $n$ \_INT\_RAW** The raw interrupt status bit for the [LEDC\\_DUTY\\_CHNG\\_END\\_LSCH \$n\$ \\_INT](#) interrupt. (RO)

**LEDC\_DUTY\_CHNG\_END\_HSCH $n$ \_INT\_RAW** The raw interrupt status bit for the [LEDC\\_DUTY\\_CHNG\\_END\\_HSCH \$n\$ \\_INT](#) interrupt. (RO)

**LEDC\_LSTIMER $x$ \_OVF\_INT\_RAW** The raw interrupt status bit for the [LEDC\\_LSTIMER \$x\$ \\_OVF\\_INT](#) interrupt. (RO)

**LEDC\_HSTIMER $x$ \_OVF\_INT\_RAW** The raw interrupt status bit for the [LEDC\\_HSTIMER \$x\$ \\_OVF\\_INT](#) interrupt. (RO)

**Register 14.16. LEDC\_INT\_ST\_REG (0x0184)**

(reserved)								LEDC_DUTY_CHNG_END_LSCH7_INT_ST LEDC_DUTY_CHNG_END_LSCH6_INT_ST LEDC_DUTY_CHNG_END_LSCH5_INT_ST LEDC_DUTY_CHNG_END_LSCH4_INT_ST LEDC_DUTY_CHNG_END_LSCH3_INT_ST LEDC_DUTY_CHNG_END_LSCH2_INT_ST LEDC_DUTY_CHNG_END_LSCH1_INT_ST LEDC_DUTY_CHNG_END_HSCH0_INT_ST LEDC_DUTY_CHNG_END_HSCH7_INT_ST LEDC_DUTY_CHNG_END_HSCH6_INT_ST LEDC_DUTY_CHNG_END_HSCH5_INT_ST LEDC_DUTY_CHNG_END_HSCH4_INT_ST LEDC_DUTY_CHNG_END_HSCH3_INT_ST LEDC_DUTY_CHNG_END_HSCH2_INT_ST LEDC_DUTY_CHNG_END_HSCH1_INT_ST LEDC_LSTIMER3_OVF_INT_ST LEDC_LSTIMER2_OVF_INT_ST LEDC_LSTIMER1_OVF_INT_ST LEDC_HSTIMER3_OVF_INT_ST LEDC_HSTIMER2_OVF_INT_ST LEDC_HSTIMER1_OVF_INT_ST LEDC_HSTIMER0_OVF_INT_ST																							
31	24	23	22	21	20	19	18	17	16	15	14	13	12	11	10	9	8	7	6	5	4	3	2	1	0	Reset					
0	0	0	0	0	0	0	0	0	0	0	0	0	0	0	0	0	0	0	0	0	0	0	0	0	0	0	0				

**LEDC\_DUTY\_CHNG\_END\_LSCH $n$ \_INT\_ST** The masked interrupt status bit for the [LEDC\\_DUTY\\_CHNG\\_END\\_LSCH \$n\$ \\_INT](#) interrupt. (RO)

**LEDC\_DUTY\_CHNG\_END\_HSCH $n$ \_INT\_ST** The masked interrupt status bit for the [LEDC\\_DUTY\\_CHNG\\_END\\_HSCH \$n\$ \\_INT](#) interrupt. (RO)

**LEDC\_LSTIMER $x$ \_OVF\_INT\_ST** The masked interrupt status bit for the [LEDC\\_LSTIMER \$x\$ \\_OVF\\_INT](#) interrupt. (RO)

**LEDC\_HSTIMER $x$ \_OVF\_INT\_ST** The masked interrupt status bit for the [LEDC\\_HSTIMER \$x\$ \\_OVF\\_INT](#) interrupt. (RO)



Register 14.17. LEDC\_INT\_ENA\_REG (0x0188)

(reserved)								LEDC_DUTY_CHNG_END_LSCH7_INT_ENA	LEDC_DUTY_CHNG_END_LSCH6_INT_ENA	LEDC_DUTY_CHNG_END_LSCH5_INT_ENA	LEDC_DUTY_CHNG_END_LSCH4_INT_ENA	LEDC_DUTY_CHNG_END_LSCH3_INT_ENA	LEDC_DUTY_CHNG_END_LSCH2_INT_ENA	LEDC_DUTY_CHNG_END_LSCH1_INT_ENA	LEDC_DUTY_CHNG_END_HSCH7_INT_ENA	LEDC_DUTY_CHNG_END_HSCH6_INT_ENA	LEDC_DUTY_CHNG_END_HSCH5_INT_ENA	LEDC_DUTY_CHNG_END_HSCH4_INT_ENA	LEDC_DUTY_CHNG_END_HSCH3_INT_ENA	LEDC_DUTY_CHNG_END_HSCH2_INT_ENA	LEDC_DUTY_CHNG_END_HSCH1_INT_ENA	LEDC_LSTIMER3_OVF_INT_ENA	LEDC_LSTIMER2_OVF_INT_ENA	LEDC_LSTIMER1_OVF_INT_ENA	LEDC_HSTIMER3_OVF_INT_ENA	LEDC_HSTIMER2_OVF_INT_ENA	LEDC_HSTIMER1_OVF_INT_ENA	LEDC_HSTIMER0_OVF_INT_ENA
31	24	23	22	21	20	19	18	17	16	15	14	13	12	11	10	9	8	7	6	5	4	3	2	1	0	Reset		
0	0	0	0	0	0	0	0	0	0	0	0	0	0	0	0	0	0	0	0	0	0	0	0	0	0	0	0	0

**LEDC\_DUTY\_CHNG\_END\_LSCH $n$ \_INT\_ENA** The interrupt enable bit for the [LEDC\\_DUTY\\_CHNG\\_END\\_LSCH \$n\$ \\_INT](#) interrupt. (R/W)

**LEDC\_DUTY\_CHNG\_END\_HSCH $n$ \_INT\_ENA** The interrupt enable bit for the [LEDC\\_DUTY\\_CHNG\\_END\\_HSCH \$n\$ \\_INT](#) interrupt. (R/W)

**LEDC\_LSTIMER $x$ \_OVF\_INT\_ENA** The interrupt enable bit for the [LEDC\\_LSTIMER \$x\$ \\_OVF\\_INT](#) interrupt. (R/W)

**LEDC\_HSTIMER $x$ \_OVF\_INT\_ENA** The interrupt enable bit for the [LEDC\\_HSTIMER \$x\$ \\_OVF\\_INT](#) interrupt. (R/W)

Register 14.18. LEDC\_INT\_CLR\_REG (0x018C)

(reserved)								LEDC_DUTY_CHNG_END_LSCH7_INT_CLR	LEDC_DUTY_CHNG_END_LSCH6_INT_CLR	LEDC_DUTY_CHNG_END_LSCH5_INT_CLR	LEDC_DUTY_CHNG_END_LSCH4_INT_CLR	LEDC_DUTY_CHNG_END_LSCH3_INT_CLR	LEDC_DUTY_CHNG_END_LSCH2_INT_CLR	LEDC_DUTY_CHNG_END_LSCH1_INT_CLR	LEDC_DUTY_CHNG_END_HSCH7_INT_CLR	LEDC_DUTY_CHNG_END_HSCH6_INT_CLR	LEDC_DUTY_CHNG_END_HSCH5_INT_CLR	LEDC_DUTY_CHNG_END_HSCH4_INT_CLR	LEDC_DUTY_CHNG_END_HSCH3_INT_CLR	LEDC_DUTY_CHNG_END_HSCH2_INT_CLR	LEDC_DUTY_CHNG_END_HSCH1_INT_CLR	LEDC_LSTIMER3_OVF_INT_CLR	LEDC_LSTIMER2_OVF_INT_CLR	LEDC_LSTIMER1_OVF_INT_CLR	LEDC_HSTIMER3_OVF_INT_CLR	LEDC_HSTIMER2_OVF_INT_CLR	LEDC_HSTIMER1_OVF_INT_CLR	LEDC_HSTIMER0_OVF_INT_CLR
31	24	23	22	21	20	19	18	17	16	15	14	13	12	11	10	9	8	7	6	5	4	3	2	1	0	Reset		
0	0	0	0	0	0	0	0	0	0	0	0	0	0	0	0	0	0	0	0	0	0	0	0	0	0	0	0	

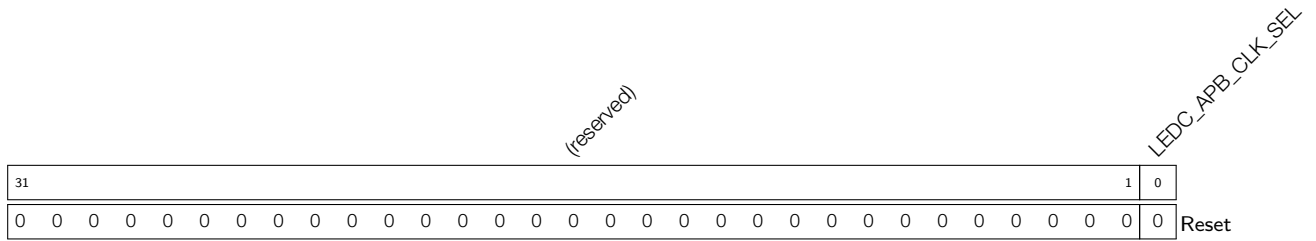
**LEDC\_DUTY\_CHNG\_END\_LSCH $n$ \_INT\_CLR** Set this bit to clear the [LEDC\\_DUTY\\_CHNG\\_END\\_LSCH \$n\$ \\_INT](#) interrupt. (WO)

**LEDC\_DUTY\_CHNG\_END\_HSCH $n$ \_INT\_CLR** Set this bit to clear the [LEDC\\_DUTY\\_CHNG\\_END\\_HSCH \$n\$ \\_INT](#) interrupt. (WO)

**LEDC\_LSTIMER $x$ \_OVF\_INT\_CLR** Set this bit to clear the [LEDC\\_LSTIMER \$x\$ \\_OVF\\_INT](#) interrupt. (WO)

**LEDC\_HSTIMER $x$ \_OVF\_INT\_CLR** Set this bit to clear the [LEDC\\_HSTIMER \$x\$ \\_OVF\\_INT](#) interrupt. (WO)

Register 14.19. LEDC\_CONF\_REG (0x0190)



**LEDC\_APB\_CLK\_SEL** This bit is used to set the frequency of SLOW\_CLK. (R/W)  
 0: 8 MHz;  
 1: 80 MHz.

## 15 Remote Control Peripheral (RMT)

### 15.1 Introduction

The RMT (Remote Control) module is primarily designed to send and receive infrared remote control signals that implement on-off keying in a carrier frequency, but due to its design it can be used to generate various types of signals. An RMT transmitter does this by reading consecutive duration values of an active and inactive output from the built-in RAM block, optionally modulating it with a carrier wave. A receiver will inspect its input signal, optionally filtering it, and will place the lengths of time the signal is active and inactive in the RAM block.

The RMT module has eight channels, numbered zero to seven; registers, signals and blocks that are duplicated in each channel are indicated by an  $n$  which is used as a placeholder for the channel number.

### 15.2 Functional Description

#### 15.2.1 RMT Architecture

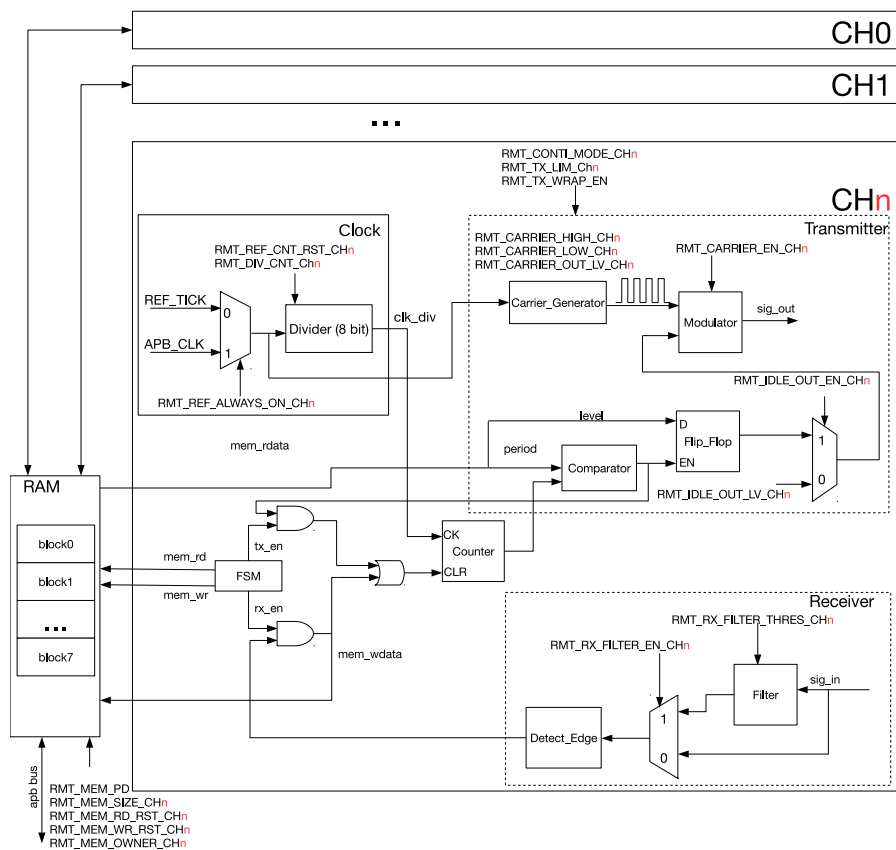


Figure 15-1. RMT Architecture

The RMT module contains eight channels. Each channel has both a transmitter and a receiver, but only one of them can be active in every channel. The eight channels share a 512x32-bit RAM block which can be read and written by the processor cores over the APB bus, read by the transmitters, and written by the receivers. The transmitted signal can optionally be modulated by a carrier wave. Each channel is clocked by a divided-down signal derived from either the APB bus clock or REF\_TICK.

## 15.2.2 RMT RAM

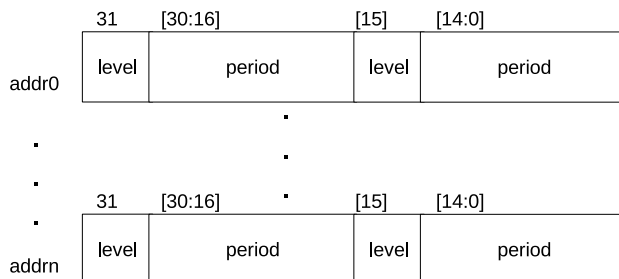


Figure 15-2. Data Structure

The data structure in RAM is shown in Figure 15-2. Each 32-bit value contains two 16-bit entries, with two fields in every entry, "level" and "period". "Level" indicates whether a high-/low-level value was received or is going to be sent, while "period" points out the divider-clock cycles for which the level lasts. A zero period is interpreted as an end-marker: the transmitter will stop transmitting once it has read this, and the receiver will write this, once it has detected that the signal it received has gone idle.

Normally, only one block of 64x32-bit worth of data can be sent or received. If the data size is larger than this block size, blocks can be extended or the channel can be configured for the wraparound mode.

The RMT RAM can be accessed via the APB bus. The initial address is 0x3FF56800. The RAM block is divided into eight 64x32-bit blocks. By default, each channel uses one block (block zero for channel zero, block one for channel one, and so on). Users can extend the memory to a specific channel by configuring the RMT\_MEM\_SIZE\_CH $n$  register; setting this to >1 will prompt the channel to use the memory of subsequent channels as well. The RAM address range of channel  $n$  is start\_addr\_CH $n$  to end\_addr\_CH $n$ , which is defined by:

start\_addr\_ch $n$  = 0x3FF56800 + 64 \* 4 \*  $n$ , and

end\_addr\_ch $n$  = 0x3FF56800 + (64 \* 4 \*  $n$  + 64 \* 4 \* RMT\_MEM\_SIZE\_CH $n$ ) mod (512 \* 4) - 4

To protect a receiver from overwriting the blocks a transmitter is about to transmit, RMT\_MEM\_OWNER\_CH $n$  can be configured to designate the owner, be it a transmitter or receiver, of channel  $n$ 's RAM block. This way, if this ownership is violated, the RMT\_CH $n$ \_ERR interrupt will be generated.

**Note:** When enabling the continuous transmission mode by setting RMT\_REG\_TX\_CONTI\_MODE, the transmitter will transmit the data on the channel continuously, that is, from the first byte to the last one, then from the first to the last again, and so on. In this mode, there will be an idle level lasting one clk\_div cycle between N and N+1 transmissions.

## 15.2.3 Clock

The main clock of a channel is generated by taking either the 80 MHz APB clock or REF\_TICK (usually 1MHz), according to the state of RMT\_REF\_ALWAYS\_ON\_CH $n$ . (For more information on clock sources, please see Chapter [Reset And Clock](#).) Then, the aforementioned state gets scaled down using a configurable 8-bit divider to create the channel clock which is used by both the carrier wave generator and the counter. The divider value can be set by configuring RMT\_DIV\_CNT\_CH $n$ .

## 15.2.4 Transmitter

When the RMT\_TX\_START\_CH $n$  register is 1, the transmitter of channel  $n$  will start reading and sending data from RAM. The transmitter will receive a 32-bit value each time it reads from RAM. Of these 32 bits, the low 16-bit entry is sent first and the high entry second.

To transmit more data than can be fitted in the channel's RAM, the wraparound mode can be enabled. In this mode, when the transmitter has reached the last entry in the channel's memory, it will loop back to the first byte. To use this mechanism for sending more data than can be fitted in the channel's RAM, fill the RAM with the initial events and set `RMT_CH $n$ _TX_LIM_REG` to cause an `RMT_CH $n$ _TX_THR_EVENT_INT` interrupt before the wraparound happens. Then, when the interrupt happens, the already sent data should be replaced by subsequent events, so that when the wraparound happens the transmitter will seamlessly continue sending the new events.

With or without the wraparound mode enabled, transmission ends when an entry with zero length is encountered. When this happens, the transmitter will generate an `RMT_CH $n$ _TX_END_INT` interrupt and return to the idle state. When a transmitter is in the idle state, the output level defaults to end-mark 0. Users can also configure `RMT_IDLE_OUT_EN_CH $n$`  and `RMT_IDLE_OUT_LV_CH $n$`  to control the output level manually.

The output of the transmitter can be modulated using a carrier wave by setting `RMT_CARRIER_EN_CH $n$` . The carrier frequency and duty cycle can be configured by adjusting the carrier's high and low durations in channel-clock cycles, in `RMT_CARRIER_HIGH_CH $n$`  and `RMT_CARRIER_LOW_CH $n$` .

### 15.2.5 Receiver

When `RMT_RX_EN_CH $n$`  is set to 1, the receiver in channel  $n$  becomes active, measuring the duration between input signal edges. These will be written as period/level value pairs to the channel RAM in the same fashion as the transmitter sends them. Receiving ends, when the receiver detects no change in signal level for more than `RMT_IDLE_THRES_CH $n$`  channel clock ticks. The receiver will write a final entry with 0 period, generate an `RMT_CH $n$ _RX_END_INT_RAW` interrupt and return to the idle state.

The receiver has an input signal filter which can be configured using `RMT_RX_FILTER_EN_CH $n$` : The filter will remove pulses with a length of less than `RMT_RX_FILTER_THRES_CH $n$`  in APB clock periods.

When the RMT module is inactive, the RAM can be put into low-power mode by setting the `RMT_MEM_PD` register to 1.

### 15.2.6 Interrupts

- `RMT_CH $n$ _TX_THR_EVENT_INT`: Triggered when the amount of data the transmitter has sent matches the value of `RMT_CH $n$ _TX_LIM_REG`.
- `RMT_CH $n$ _TX_END_INT`: Triggered when the transmitter has finished transmitting the signal.
- `RMT_CH $n$ _RX_END_INT`: Triggered when the receiver has finished receiving a signal.

## 15.3 Register Summary

Name	Description	Address	Access
<b>Configuration registers</b>			
<a href="#">RMT_CH0CONF0_REG</a>	Channel 0 config register 0	0x3FF56020	R/W
<a href="#">RMT_CH0CONF1_REG</a>	Channel 0 config register 1	0x3FF56024	R/W
<a href="#">RMT_CH1CONF0_REG</a>	Channel 1 config register 0	0x3FF56028	R/W
<a href="#">RMT_CH1CONF1_REG</a>	Channel 1 config register 1	0x3FF5602C	R/W
<a href="#">RMT_CH2CONF0_REG</a>	Channel 2 config register 0	0x3FF56030	R/W
<a href="#">RMT_CH2CONF1_REG</a>	Channel 2 config register 1	0x3FF56034	R/W
<a href="#">RMT_CH3CONF0_REG</a>	Channel 3 config register 0	0x3FF56038	R/W
<a href="#">RMT_CH3CONF1_REG</a>	Channel 3 config register 1	0x3FF5603C	R/W

RMT_CH4CONF0_REG	Channel 4 config register 0	0x3FF56040	R/W
RMT_CH4CONF1_REG	Channel 4 config register 1	0x3FF56044	R/W
RMT_CH5CONF0_REG	Channel 5 config register 0	0x3FF56048	R/W
RMT_CH5CONF1_REG	Channel 5 config register 1	0x3FF5604C	R/W
RMT_CH6CONF0_REG	Channel 6 config register 0	0x3FF56050	R/W
RMT_CH6CONF1_REG	Channel 6 config register 1	0x3FF56054	R/W
RMT_CH7CONF0_REG	Channel 7 config register 0	0x3FF56058	R/W
RMT_CH7CONF1_REG	Channel 7 config register 1	0x3FF5605C	R/W
<b>Interrupt registers</b>			
RMT_INT_RAW_REG	Raw interrupt status	0x3FF560A0	RO
RMT_INT_ST_REG	Masked interrupt status	0x3FF560A4	RO
RMT_INT_ENA_REG	Interrupt enable bits	0x3FF560A8	R/W
RMT_INT_CLR_REG	Interrupt clear bits	0x3FF560AC	WO
<b>Carrier wave duty cycle registers</b>			
RMT_CH0CARRIER_DUTY_REG	Channel 0 duty cycle configuration register	0x3FF560B0	R/W
RMT_CH1CARRIER_DUTY_REG	Channel 1 duty cycle configuration register	0x3FF560B4	R/W
RMT_CH2CARRIER_DUTY_REG	Channel 2 duty cycle configuration register	0x3FF560B8	R/W
RMT_CH3CARRIER_DUTY_REG	Channel 3 duty cycle configuration register	0x3FF560BC	R/W
RMT_CH4CARRIER_DUTY_REG	Channel 4 duty cycle configuration register	0x3FF560C0	R/W
RMT_CH5CARRIER_DUTY_REG	Channel 5 duty cycle configuration register	0x3FF560C4	R/W
RMT_CH6CARRIER_DUTY_REG	Channel 6 duty cycle configuration register	0x3FF560C8	R/W
RMT_CH7CARRIER_DUTY_REG	Channel 7 duty cycle configuration register	0x3FF560CC	R/W
<b>Tx event configuration registers</b>			
RMT_CH0_TX_LIM_REG	Channel 0 Tx event configuration register	0x3FF560D0	R/W
RMT_CH1_TX_LIM_REG	Channel 1 Tx event configuration register	0x3FF560D4	R/W
RMT_CH2_TX_LIM_REG	Channel 2 Tx event configuration register	0x3FF560D8	R/W
RMT_CH3_TX_LIM_REG	Channel 3 Tx event configuration register	0x3FF560DC	R/W
RMT_CH4_TX_LIM_REG	Channel 4 Tx event configuration register	0x3FF560E0	R/W
RMT_CH5_TX_LIM_REG	Channel 5 Tx event configuration register	0x3FF560E4	R/W
RMT_CH6_TX_LIM_REG	Channel 6 Tx event configuration register	0x3FF560E8	R/W
RMT_CH7_TX_LIM_REG	Channel 7 Tx event configuration register	0x3FF560EC	R/W
<b>Other registers</b>			
RMT_APB_CONF_REG	RMT-wide configuration register	0x3FF560F0	R/W

## 15.4 Registers

The addresses in parenthesis besides register names are the register addresses relative to the RMT base address provided in Table 1-6 *Peripheral Address Mapping* in Chapter 1 *System and Memory*. The absolute register addresses are listed in Section 15.3 *Register Summary*.

**Register 15.1. RMT\_CH $n$ CONF0\_REG ( $n$ : 0-7) (0x0020+8\* $n$ )**

(reserved)		RMT_MEM_PD		RMT_CARRIER_OUT_LV_CH $n$		RMT_CARRIER_EN_CH $n$		RMT_MEM_SIZE_CH $n$		RMT_IDLE_THRES_CH $n$		RMT_DIV_CNT_CH $n$	
31	30	29	28	27	24	23		8	7				0
0x0	0	1	1		0x01			0x01000					0x002
													Reset

**RMT\_MEM\_PD** This bit is used to power down the entire RMT RAM block. (It only exists in RMT\_CH0CONF0). 1: power down memory; 0: power up memory. (R/W)

**RMT\_CARRIER\_OUT\_LV\_CH $n$**  This bit is used for configuration when the carrier wave is being transmitted. Transmit on low output level with 0, and transmit on high output level with 1. (R/W)

**RMT\_CARRIER\_EN\_CH $n$**  This is the carrier modulation enable-control bit for channel  $n$ . Carrier modulation is enabled with 1, while carrier modulation is disabled with 0. (R/W)

**RMT\_MEM\_SIZE\_CH $n$**  This register is used to configure the amount of memory blocks allocated to channel  $n$ . (R/W)

**RMT\_IDLE\_THRES\_CH $n$**  In receive mode, when no edge is detected on the input signal for longer than REG\_IDLE\_THRES\_CH $n$  channel clock cycles, the receive process is finished. (R/W)

**RMT\_DIV\_CNT\_CH $n$**  This register is used to set the divider for the channel clock of channel  $n$ . (R/W)

Register 15.2. RMT\_CH $n$ CONF1\_REG ( $n$ : 0-7) (0x0024+8\* $n$ )

(reserved)				RMT_IDLE_OUT_EN_CH $n$ RMT_IDLE_OUT_LV_CH $n$ RMT_REF_ALWAYS_ON_CH $n$ RMT_REF_CNT_RST_CH $n$				RMT_RX_FILTER_THRES_CH $n$				RMT_RX_FILTER_EN_CH $n$ RMT_TX_CONTI_MODE_CH $n$ RMT_MEM_OWNER_CH $n$ (reserved) RMT_MEM_RD_RST_CH $n$ RMT_MEM_WR_RST_CH $n$ RMT_RX_EN_CH $n$ RMT_TX_START_CH $n$			
31	20	19	18	17	16	15	8	7	6	5	4	3	2	1	0
0x0000						0x00F						Reset			

**RMT\_IDLE\_OUT\_EN\_CH $n$**  This is the output enable-control bit for channel  $n$  in IDLE state. (R/W)

**RMT\_IDLE\_OUT\_LV\_CH $n$**  This bit configures the level of output signals in channel  $n$  when the latter is in IDLE state. (R/W)

**RMT\_REF\_ALWAYS\_ON\_CH $n$**  This bit is used to select the channel's base clock. 1:clk\_apb; 0:clk\_ref. (R/W)

**RMT\_REF\_CNT\_RST\_CH $n$**  Setting this bit resets the clock divider of channel  $n$ . (R/W)

**RMT\_RX\_FILTER\_THRES\_CH $n$**  In receive mode, channel  $n$  ignores input pulse when the pulse width is smaller than this value in APB clock periods. (R/W)

**RMT\_RX\_FILTER\_EN\_CH $n$**  This is the receive filter's enable-bit for channel  $n$ . (R/W)

**RMT\_TX\_CONTI\_MODE\_CH $n$**  If this bit is set, instead of going to an idle state when transmission ends, the transmitter will restart transmission. This results in a repeating output signal. (R/W)

**RMT\_MEM\_OWNER\_CH $n$**  This bit marks channel  $n$ 's RAM block ownership. Number 1 indicates that the receiver is using the RAM, while 0 indicates that the transmitter is using the RAM. (R/W)

**RMT\_MEM\_RD\_RST\_CH $n$**  Set this bit to reset the read-RAM address for channel  $n$  by accessing the transmitter. (R/W)

**RMT\_MEM\_WR\_RST\_CH $n$**  Set this bit to reset the write-RAM address for channel  $n$  by accessing the receiver. (R/W)

**RMT\_RX\_EN\_CH $n$**  Set this bit to enable receiving data on channel  $n$ . (R/W)

**RMT\_TX\_START\_CH $n$**  Set this bit to start sending data on channel  $n$ . (R/W)



**Register 15.3. RMT\_INT\_RAW\_REG (0x00A0)**

<div style="display: flex; justify-content: space-between;"> <div style="writing-mode: vertical-rl; transform: rotate(180deg);">RMT_CH7_TX_THR_EVENT_INT_RAW</div> <div style="writing-mode: vertical-rl; transform: rotate(180deg);">RMT_CH6_TX_THR_EVENT_INT_RAW</div> <div style="writing-mode: vertical-rl; transform: rotate(180deg);">RMT_CH5_TX_THR_EVENT_INT_RAW</div> <div style="writing-mode: vertical-rl; transform: rotate(180deg);">RMT_CH4_TX_THR_EVENT_INT_RAW</div> <div style="writing-mode: vertical-rl; transform: rotate(180deg);">RMT_CH3_TX_THR_EVENT_INT_RAW</div> <div style="writing-mode: vertical-rl; transform: rotate(180deg);">RMT_CH2_TX_THR_EVENT_INT_RAW</div> <div style="writing-mode: vertical-rl; transform: rotate(180deg);">RMT_CH1_TX_THR_EVENT_INT_RAW</div> <div style="writing-mode: vertical-rl; transform: rotate(180deg);">RMT_CH0_TX_THR_EVENT_INT_RAW</div> <div style="writing-mode: vertical-rl; transform: rotate(180deg);">RMT_CH7_ERR_INT_RAW</div> <div style="writing-mode: vertical-rl; transform: rotate(180deg);">RMT_CH6_ERR_INT_RAW</div> <div style="writing-mode: vertical-rl; transform: rotate(180deg);">RMT_CH5_ERR_INT_RAW</div> <div style="writing-mode: vertical-rl; transform: rotate(180deg);">RMT_CH4_ERR_INT_RAW</div> <div style="writing-mode: vertical-rl; transform: rotate(180deg);">RMT_CH3_ERR_INT_RAW</div> <div style="writing-mode: vertical-rl; transform: rotate(180deg);">RMT_CH2_ERR_INT_RAW</div> <div style="writing-mode: vertical-rl; transform: rotate(180deg);">RMT_CH1_ERR_INT_RAW</div> <div style="writing-mode: vertical-rl; transform: rotate(180deg);">RMT_CH0_ERR_INT_RAW</div> <div style="writing-mode: vertical-rl; transform: rotate(180deg);">RMT_CH7_RX_END_INT_RAW</div> <div style="writing-mode: vertical-rl; transform: rotate(180deg);">RMT_CH6_RX_END_INT_RAW</div> <div style="writing-mode: vertical-rl; transform: rotate(180deg);">RMT_CH5_RX_END_INT_RAW</div> <div style="writing-mode: vertical-rl; transform: rotate(180deg);">RMT_CH4_RX_END_INT_RAW</div> <div style="writing-mode: vertical-rl; transform: rotate(180deg);">RMT_CH3_RX_END_INT_RAW</div> <div style="writing-mode: vertical-rl; transform: rotate(180deg);">RMT_CH2_RX_END_INT_RAW</div> <div style="writing-mode: vertical-rl; transform: rotate(180deg);">RMT_CH1_RX_END_INT_RAW</div> <div style="writing-mode: vertical-rl; transform: rotate(180deg);">RMT_CH0_RX_END_INT_RAW</div> <div style="writing-mode: vertical-rl; transform: rotate(180deg);">RMT_CH7_TX_END_INT_RAW</div> <div style="writing-mode: vertical-rl; transform: rotate(180deg);">RMT_CH6_TX_END_INT_RAW</div> <div style="writing-mode: vertical-rl; transform: rotate(180deg);">RMT_CH5_TX_END_INT_RAW</div> <div style="writing-mode: vertical-rl; transform: rotate(180deg);">RMT_CH4_TX_END_INT_RAW</div> <div style="writing-mode: vertical-rl; transform: rotate(180deg);">RMT_CH3_TX_END_INT_RAW</div> <div style="writing-mode: vertical-rl; transform: rotate(180deg);">RMT_CH2_TX_END_INT_RAW</div> <div style="writing-mode: vertical-rl; transform: rotate(180deg);">RMT_CH1_TX_END_INT_RAW</div> <div style="writing-mode: vertical-rl; transform: rotate(180deg);">RMT_CH0_TX_END_INT_RAW</div> </div>																															
31	30	29	28	27	26	25	24	23	22	21	20	19	18	17	16	15	14	13	12	11	10	9	8	7	6	5	4	3	2	1	0
0	0	0	0	0	0	0	0	0	0	0	0	0	0	0	0	0	0	0	0	0	0	0	0	0	0	0	0	0	0	0	0

Reset

- RMT\_CH $n$ \_TX\_THR\_EVENT\_INT\_RAW** The raw interrupt status bit for the [RMT\\_CH \$n\$ \\_TX\\_THR\\_EVENT\\_INT](#) interrupt. (RO)
- RMT\_CH $n$ \_ERR\_INT\_RAW** The raw interrupt status bit for the [RMT\\_CH \$n\$ \\_ERR\\_INT](#) interrupt. (RO)
- RMT\_CH $n$ \_RX\_END\_INT\_RAW** The raw interrupt status bit for the [RMT\\_CH \$n\$ \\_RX\\_END\\_INT](#) interrupt. (RO)
- RMT\_CH $n$ \_TX\_END\_INT\_RAW** The raw interrupt status bit for the [RMT\\_CH \$n\$ \\_TX\\_END\\_INT](#) interrupt. (RO)

**Register 15.4. RMT\_INT\_ST\_REG (0x00A4)**

<div style="display: flex; justify-content: space-between;"> <div style="writing-mode: vertical-rl; transform: rotate(180deg);">RMT_CH7_TX_THR_EVENT_INT_ST</div> <div style="writing-mode: vertical-rl; transform: rotate(180deg);">RMT_CH6_TX_THR_EVENT_INT_ST</div> <div style="writing-mode: vertical-rl; transform: rotate(180deg);">RMT_CH5_TX_THR_EVENT_INT_ST</div> <div style="writing-mode: vertical-rl; transform: rotate(180deg);">RMT_CH4_TX_THR_EVENT_INT_ST</div> <div style="writing-mode: vertical-rl; transform: rotate(180deg);">RMT_CH3_TX_THR_EVENT_INT_ST</div> <div style="writing-mode: vertical-rl; transform: rotate(180deg);">RMT_CH2_TX_THR_EVENT_INT_ST</div> <div style="writing-mode: vertical-rl; transform: rotate(180deg);">RMT_CH1_TX_THR_EVENT_INT_ST</div> <div style="writing-mode: vertical-rl; transform: rotate(180deg);">RMT_CH0_TX_THR_EVENT_INT_ST</div> <div style="writing-mode: vertical-rl; transform: rotate(180deg);">RMT_CH7_ERR_INT_ST</div> <div style="writing-mode: vertical-rl; transform: rotate(180deg);">RMT_CH6_ERR_INT_ST</div> <div style="writing-mode: vertical-rl; transform: rotate(180deg);">RMT_CH5_ERR_INT_ST</div> <div style="writing-mode: vertical-rl; transform: rotate(180deg);">RMT_CH4_ERR_INT_ST</div> <div style="writing-mode: vertical-rl; transform: rotate(180deg);">RMT_CH3_ERR_INT_ST</div> <div style="writing-mode: vertical-rl; transform: rotate(180deg);">RMT_CH2_ERR_INT_ST</div> <div style="writing-mode: vertical-rl; transform: rotate(180deg);">RMT_CH1_ERR_INT_ST</div> <div style="writing-mode: vertical-rl; transform: rotate(180deg);">RMT_CH0_ERR_INT_ST</div> <div style="writing-mode: vertical-rl; transform: rotate(180deg);">RMT_CH7_RX_END_INT_ST</div> <div style="writing-mode: vertical-rl; transform: rotate(180deg);">RMT_CH6_RX_END_INT_ST</div> <div style="writing-mode: vertical-rl; transform: rotate(180deg);">RMT_CH5_RX_END_INT_ST</div> <div style="writing-mode: vertical-rl; transform: rotate(180deg);">RMT_CH4_RX_END_INT_ST</div> <div style="writing-mode: vertical-rl; transform: rotate(180deg);">RMT_CH3_RX_END_INT_ST</div> <div style="writing-mode: vertical-rl; transform: rotate(180deg);">RMT_CH2_RX_END_INT_ST</div> <div style="writing-mode: vertical-rl; transform: rotate(180deg);">RMT_CH1_RX_END_INT_ST</div> <div style="writing-mode: vertical-rl; transform: rotate(180deg);">RMT_CH0_RX_END_INT_ST</div> <div style="writing-mode: vertical-rl; transform: rotate(180deg);">RMT_CH7_TX_END_INT_ST</div> <div style="writing-mode: vertical-rl; transform: rotate(180deg);">RMT_CH6_TX_END_INT_ST</div> <div style="writing-mode: vertical-rl; transform: rotate(180deg);">RMT_CH5_TX_END_INT_ST</div> <div style="writing-mode: vertical-rl; transform: rotate(180deg);">RMT_CH4_TX_END_INT_ST</div> <div style="writing-mode: vertical-rl; transform: rotate(180deg);">RMT_CH3_TX_END_INT_ST</div> <div style="writing-mode: vertical-rl; transform: rotate(180deg);">RMT_CH2_TX_END_INT_ST</div> <div style="writing-mode: vertical-rl; transform: rotate(180deg);">RMT_CH1_TX_END_INT_ST</div> <div style="writing-mode: vertical-rl; transform: rotate(180deg);">RMT_CH0_TX_END_INT_ST</div> </div>																															
31	30	29	28	27	26	25	24	23	22	21	20	19	18	17	16	15	14	13	12	11	10	9	8	7	6	5	4	3	2	1	0
0	0	0	0	0	0	0	0	0	0	0	0	0	0	0	0	0	0	0	0	0	0	0	0	0	0	0	0	0	0	0	0

Reset

- RMT\_CH $n$ \_TX\_THR\_EVENT\_INT\_ST** The masked interrupt status bit for the [RMT\\_CH \$n\$ \\_TX\\_THR\\_EVENT\\_INT](#) interrupt. (RO)
- RMT\_CH $n$ \_ERR\_INT\_ST** The masked interrupt status bit for the [RMT\\_CH \$n\$ \\_ERR\\_INT](#) interrupt. (RO)
- RMT\_CH $n$ \_RX\_END\_INT\_ST** The masked interrupt status bit for the [RMT\\_CH \$n\$ \\_RX\\_END\\_INT](#) interrupt. (RO)
- RMT\_CH $n$ \_TX\_END\_INT\_ST** The masked interrupt status bit for the [RMT\\_CH \$n\$ \\_TX\\_END\\_INT](#) interrupt. (RO)

**Register 15.5. RMT\_INT\_ENA\_REG (0x00A8)**

<div style="display: flex; justify-content: space-between;"> <div style="writing-mode: vertical-rl; transform: rotate(180deg);">RMT_CH7_TX_THR_EVENT_INT_ENA</div> <div style="writing-mode: vertical-rl; transform: rotate(180deg);">RMT_CH6_TX_THR_EVENT_INT_ENA</div> <div style="writing-mode: vertical-rl; transform: rotate(180deg);">RMT_CH5_TX_THR_EVENT_INT_ENA</div> <div style="writing-mode: vertical-rl; transform: rotate(180deg);">RMT_CH4_TX_THR_EVENT_INT_ENA</div> <div style="writing-mode: vertical-rl; transform: rotate(180deg);">RMT_CH3_TX_THR_EVENT_INT_ENA</div> <div style="writing-mode: vertical-rl; transform: rotate(180deg);">RMT_CH2_TX_THR_EVENT_INT_ENA</div> <div style="writing-mode: vertical-rl; transform: rotate(180deg);">RMT_CH1_TX_THR_EVENT_INT_ENA</div> <div style="writing-mode: vertical-rl; transform: rotate(180deg);">RMT_CH0_TX_THR_EVENT_INT_ENA</div> <div style="writing-mode: vertical-rl; transform: rotate(180deg);">RMT_CH7_ERR_INT_ENA</div> <div style="writing-mode: vertical-rl; transform: rotate(180deg);">RMT_CH6_ERR_INT_ENA</div> <div style="writing-mode: vertical-rl; transform: rotate(180deg);">RMT_CH5_ERR_INT_ENA</div> <div style="writing-mode: vertical-rl; transform: rotate(180deg);">RMT_CH4_ERR_INT_ENA</div> <div style="writing-mode: vertical-rl; transform: rotate(180deg);">RMT_CH3_ERR_INT_ENA</div> <div style="writing-mode: vertical-rl; transform: rotate(180deg);">RMT_CH2_ERR_INT_ENA</div> <div style="writing-mode: vertical-rl; transform: rotate(180deg);">RMT_CH1_ERR_INT_ENA</div> <div style="writing-mode: vertical-rl; transform: rotate(180deg);">RMT_CH0_ERR_INT_ENA</div> <div style="writing-mode: vertical-rl; transform: rotate(180deg);">RMT_CH7_RX_END_INT_ENA</div> <div style="writing-mode: vertical-rl; transform: rotate(180deg);">RMT_CH6_RX_END_INT_ENA</div> <div style="writing-mode: vertical-rl; transform: rotate(180deg);">RMT_CH5_RX_END_INT_ENA</div> <div style="writing-mode: vertical-rl; transform: rotate(180deg);">RMT_CH4_RX_END_INT_ENA</div> <div style="writing-mode: vertical-rl; transform: rotate(180deg);">RMT_CH3_RX_END_INT_ENA</div> <div style="writing-mode: vertical-rl; transform: rotate(180deg);">RMT_CH2_RX_END_INT_ENA</div> <div style="writing-mode: vertical-rl; transform: rotate(180deg);">RMT_CH1_RX_END_INT_ENA</div> <div style="writing-mode: vertical-rl; transform: rotate(180deg);">RMT_CH0_RX_END_INT_ENA</div> <div style="writing-mode: vertical-rl; transform: rotate(180deg);">RMT_CH7_TX_END_INT_ENA</div> <div style="writing-mode: vertical-rl; transform: rotate(180deg);">RMT_CH6_TX_END_INT_ENA</div> <div style="writing-mode: vertical-rl; transform: rotate(180deg);">RMT_CH5_TX_END_INT_ENA</div> <div style="writing-mode: vertical-rl; transform: rotate(180deg);">RMT_CH4_TX_END_INT_ENA</div> <div style="writing-mode: vertical-rl; transform: rotate(180deg);">RMT_CH3_TX_END_INT_ENA</div> <div style="writing-mode: vertical-rl; transform: rotate(180deg);">RMT_CH2_TX_END_INT_ENA</div> <div style="writing-mode: vertical-rl; transform: rotate(180deg);">RMT_CH1_TX_END_INT_ENA</div> <div style="writing-mode: vertical-rl; transform: rotate(180deg);">RMT_CH0_TX_END_INT_ENA</div> </div>																																		
31	30	29	28	27	26	25	24	23	22	21	20	19	18	17	16	15	14	13	12	11	10	9	8	7	6	5	4	3	2	1	0			
0	0	0	0	0	0	0	0	0	0	0	0	0	0	0	0	0	0	0	0	0	0	0	0	0	0	0	0	0	0	0	0	0	0	Reset

**RMT\_CH<sub>n</sub>TX\_THR\_EVENT\_INT\_ENA** The interrupt enable bit for the [RMT\\_CH<sub>n</sub>TX\\_THR\\_EVENT\\_INT](#) interrupt. (R/W)

**RMT\_CH<sub>n</sub>ERR\_INT\_ENA** The interrupt enable bit for the [RMT\\_CH<sub>n</sub>ERROR\\_INT](#) interrupt. (R/W)

**RMT\_CH<sub>n</sub>RX\_END\_INT\_ENA** The interrupt enable bit for the [RMT\\_CH<sub>n</sub>RX\\_END\\_INT](#) interrupt. (R/W)

**RMT\_CH<sub>n</sub>TX\_END\_INT\_ENA** The interrupt enable bit for the [RMT\\_CH<sub>n</sub>TX\\_END\\_INT](#) interrupt. (R/W)

**Register 15.6. RMT\_INT\_CLR\_REG (0x00AC)**

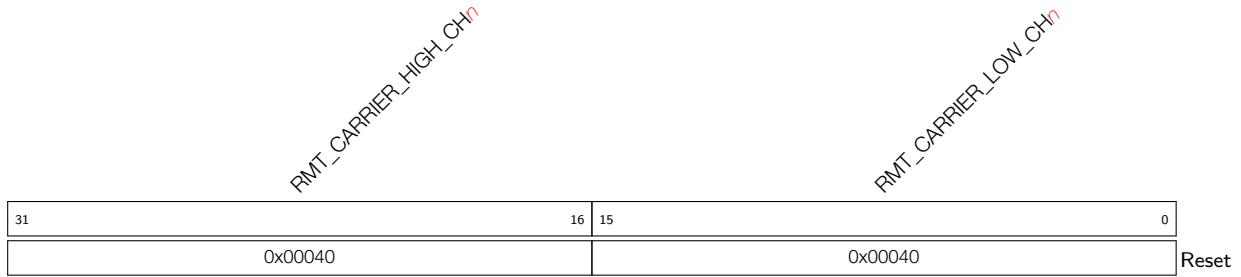
<div style="display: flex; justify-content: space-between;"> <div style="writing-mode: vertical-rl; transform: rotate(180deg);">RMT_CH7_TX_THR_EVENT_INT_CLR</div> <div style="writing-mode: vertical-rl; transform: rotate(180deg);">RMT_CH6_TX_THR_EVENT_INT_CLR</div> <div style="writing-mode: vertical-rl; transform: rotate(180deg);">RMT_CH5_TX_THR_EVENT_INT_CLR</div> <div style="writing-mode: vertical-rl; transform: rotate(180deg);">RMT_CH4_TX_THR_EVENT_INT_CLR</div> <div style="writing-mode: vertical-rl; transform: rotate(180deg);">RMT_CH3_TX_THR_EVENT_INT_CLR</div> <div style="writing-mode: vertical-rl; transform: rotate(180deg);">RMT_CH2_TX_THR_EVENT_INT_CLR</div> <div style="writing-mode: vertical-rl; transform: rotate(180deg);">RMT_CH1_TX_THR_EVENT_INT_CLR</div> <div style="writing-mode: vertical-rl; transform: rotate(180deg);">RMT_CH0_TX_THR_EVENT_INT_CLR</div> <div style="writing-mode: vertical-rl; transform: rotate(180deg);">RMT_CH7_ERR_INT_CLR</div> <div style="writing-mode: vertical-rl; transform: rotate(180deg);">RMT_CH6_ERR_INT_CLR</div> <div style="writing-mode: vertical-rl; transform: rotate(180deg);">RMT_CH5_ERR_INT_CLR</div> <div style="writing-mode: vertical-rl; transform: rotate(180deg);">RMT_CH4_ERR_INT_CLR</div> <div style="writing-mode: vertical-rl; transform: rotate(180deg);">RMT_CH3_ERR_INT_CLR</div> <div style="writing-mode: vertical-rl; transform: rotate(180deg);">RMT_CH2_ERR_INT_CLR</div> <div style="writing-mode: vertical-rl; transform: rotate(180deg);">RMT_CH1_ERR_INT_CLR</div> <div style="writing-mode: vertical-rl; transform: rotate(180deg);">RMT_CH0_ERR_INT_CLR</div> <div style="writing-mode: vertical-rl; transform: rotate(180deg);">RMT_CH7_RX_END_INT_CLR</div> <div style="writing-mode: vertical-rl; transform: rotate(180deg);">RMT_CH6_RX_END_INT_CLR</div> <div style="writing-mode: vertical-rl; transform: rotate(180deg);">RMT_CH5_RX_END_INT_CLR</div> <div style="writing-mode: vertical-rl; transform: rotate(180deg);">RMT_CH4_RX_END_INT_CLR</div> <div style="writing-mode: vertical-rl; transform: rotate(180deg);">RMT_CH3_RX_END_INT_CLR</div> <div style="writing-mode: vertical-rl; transform: rotate(180deg);">RMT_CH2_RX_END_INT_CLR</div> <div style="writing-mode: vertical-rl; transform: rotate(180deg);">RMT_CH1_RX_END_INT_CLR</div> <div style="writing-mode: vertical-rl; transform: rotate(180deg);">RMT_CH0_RX_END_INT_CLR</div> <div style="writing-mode: vertical-rl; transform: rotate(180deg);">RMT_CH7_TX_END_INT_CLR</div> <div style="writing-mode: vertical-rl; transform: rotate(180deg);">RMT_CH6_TX_END_INT_CLR</div> <div style="writing-mode: vertical-rl; transform: rotate(180deg);">RMT_CH5_TX_END_INT_CLR</div> <div style="writing-mode: vertical-rl; transform: rotate(180deg);">RMT_CH4_TX_END_INT_CLR</div> <div style="writing-mode: vertical-rl; transform: rotate(180deg);">RMT_CH3_TX_END_INT_CLR</div> <div style="writing-mode: vertical-rl; transform: rotate(180deg);">RMT_CH2_TX_END_INT_CLR</div> <div style="writing-mode: vertical-rl; transform: rotate(180deg);">RMT_CH1_TX_END_INT_CLR</div> <div style="writing-mode: vertical-rl; transform: rotate(180deg);">RMT_CH0_TX_END_INT_CLR</div> </div>																																	
31	30	29	28	27	26	25	24	23	22	21	20	19	18	17	16	15	14	13	12	11	10	9	8	7	6	5	4	3	2	1	0		
0	0	0	0	0	0	0	0	0	0	0	0	0	0	0	0	0	0	0	0	0	0	0	0	0	0	0	0	0	0	0	0	0	Reset

**RMT\_CH<sub>n</sub>TX\_THR\_EVENT\_INT\_CLR** Set this bit to clear the [RMT\\_CH<sub>n</sub>TX\\_THR\\_EVENT\\_INT](#) interrupt. (WO)

**RMT\_CH<sub>n</sub>ERR\_INT\_CLR** Set this bit to clear the [RMT\\_CH<sub>n</sub>ERR\\_INT](#) interrupt. (WO)

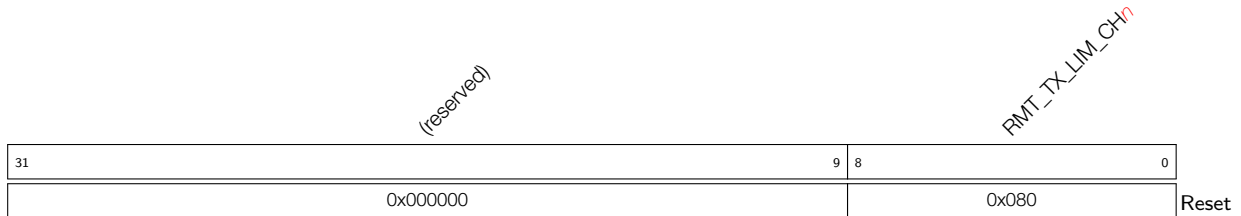
**RMT\_CH<sub>n</sub>RX\_END\_INT\_CLR** Set this bit to clear the [RMT\\_CH<sub>n</sub>RX\\_END\\_INT](#) interrupt. (WO)

**RMT\_CH<sub>n</sub>TX\_END\_INT\_CLR** Set this bit to clear the [RMT\\_CH<sub>n</sub>TX\\_END\\_INT](#) interrupt. (WO)

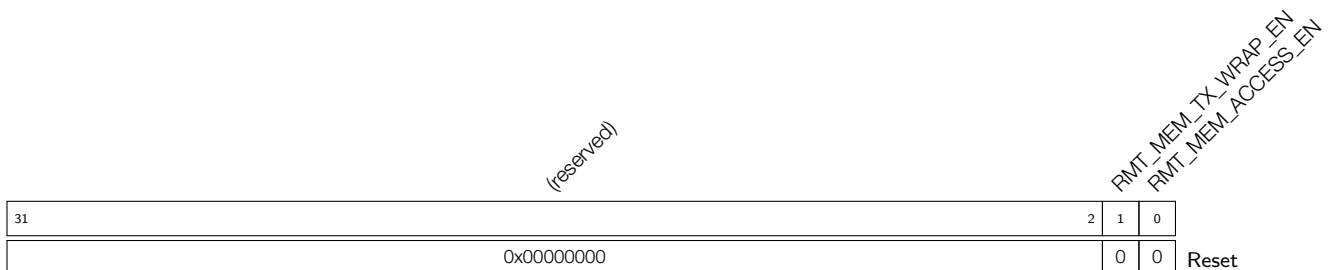
**Register 15.7. RMT\_CH $n$ CARRIER\_DUTY\_REG ( $n$ : 0-7) (0x00B0+4\* $n$ )**

**RMT\_CARRIER\_HIGH\_CH $n$**  This field is used to configure the carrier wave's high-level clock period for channel  $n$ . The clock source can be either REF\_TICK or APB\_CLK. (R/W)

**RMT\_CARRIER\_LOW\_CH $n$**  This field is used to configure the carrier wave's low-level clock period for channel  $n$ . The clock source can be either REF\_TICK or APB\_CLK. (R/W)

**Register 15.8. RMT\_CH $n$ \_TX\_LIM\_REG ( $n$ : 0-7) (0x00D0+4\* $n$ )**

**RMT\_TX\_LIM\_CH $n$**  When channel  $n$  sends more entries than specified here, it produces a TX\_THR\_EVENT interrupt. (R/W)

**Register 15.9. RMT\_APB\_CONF\_REG (0x00F0)**

**RMT\_MEM\_TX\_WRAP\_EN** This bit enables wraparound mode: when the transmitter of a channel has reached the end of its memory block, it will resume sending at the start of its memory region. (R/W)

**RMT\_MEM\_ACCESS\_EN** This bit must be 1 in order to access the RMT memory.

## 16 Motor Control PWM (PWM)

### 16.1 Introduction

The **Motor Control Pulse Width Modulator (MCPWM)** peripheral is intended for motor and power control. It provides six PWM outputs that can be set up to operate in several topologies. One common topology uses a pair of PWM outputs driving an H-bridge to control motor rotation speed and rotation direction.

The timing and control resources inside are allocated into two major types of submodules: PWM timers and PWM operators. Each PWM timer provides timing references that can either run freely or be synced to other timers or external sources. Each PWM operator has all necessary control resources to generate waveform pairs for one PWM channel. The MCPWM peripheral also contains a dedicated capture submodule that is used in systems where accurate timing of external events is important.

ESP32 contains two MCPWM peripherals: MCPWM0 and MCPWM1. Their [control registers](#) are located in 4-KB memory blocks starting at memory locations 0x3FF5E000 and 0x3FF6C000 respectively.

### 16.2 Features

Each MCPWM peripheral has one clock divider (prescaler), three PWM timers, three PWM operators, and a capture module. Figure 16-1 shows the submodules inside and the signals on the interface. PWM timers are used for generating timing references. The PWM operators generate desired waveform based on the timing references. Any PWM operator can be configured to use the timing references of any PWM timers. Different PWM operators can use the same PWM timer's timing references to produce related PWM signals. PWM operators can also use different PWM timers' values to produce the PWM signals that work alone. Different PWM timers can also be synced together.

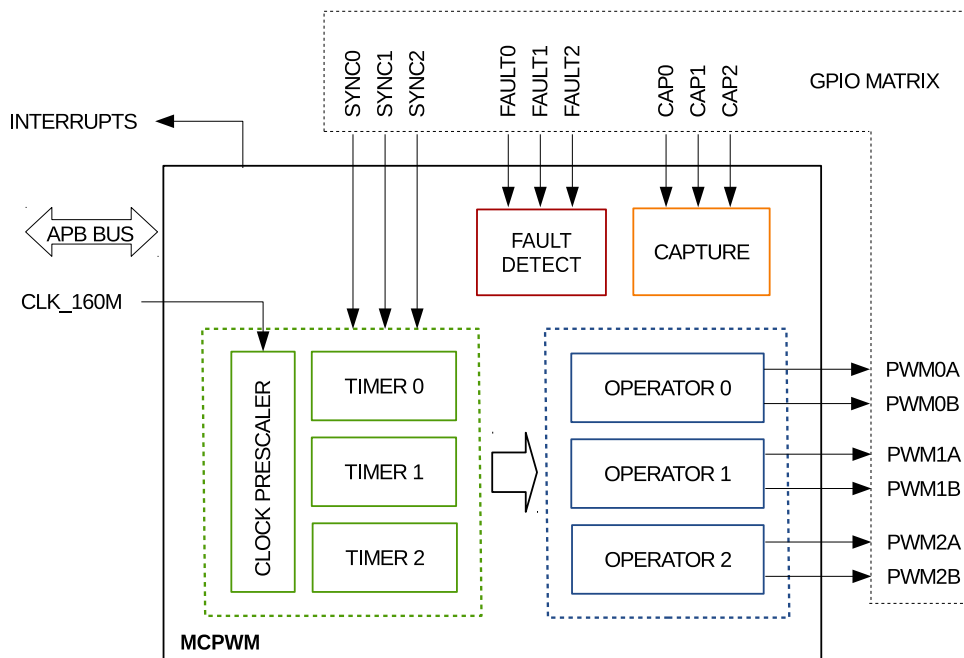


Figure 16-1. MCPWM Module Overview

An overview of the submodules' function in Figure 16-1 is shown below:

- PWM Timers 0, 1 and 2
  - Every PWM timer has a dedicated 8-bit clock prescaler.
  - The 16-bit counter in the PWM timer can work in count-up mode, count-down mode or count-up-down mode.
  - A hardware sync can trigger a reload on the PWM timer with a phase register. It will also trigger the prescaler's restart, so that the timer's clock can also be synced. The source of the sync can come from any GPIO or any other PWM timer's sync\_out.
- PWM Operators 0, 1 and 2
  - Every PWM operator has two PWM outputs: PWMxA and PWMxB. They can work independently, in symmetric and asymmetric configuration.
  - Software, asynchronous override control of PWM signals.
  - Configurable dead-time on rising and falling edges; each set up independently.
  - All events can trigger CPU interrupts.
  - Modulating of PWM output by high-frequency carrier signals, useful when gate drives are insulated with a transformer.
  - Period, time stamps and important control registers have shadow registers with flexible updating methods.
- Fault Detection Module
  - Programmable fault handling allocated on fault condition in both cycle-by-cycle mode and one-shot mode.
  - A fault condition can force the PWM output to either high or low logic levels.
- Capture Module
  - Speed measurement of rotating machinery (for example, toothed sprockets sensed with Hall sensors)
  - Measurement of elapsed time between position sensor pulses
  - Period and duty-cycle measurement of pulse train signals
  - Decoding current or voltage amplitude derived from duty-cycle-encoded signals from current/voltage sensors
  - Three individual capture channels, each of which has a time-stamp register (32 bits)
  - Selection of edge polarity and prescaling of input capture signal
  - The capture timer can sync with a PWM timer or external signals.
  - Interrupt on each of the three capture channels

## 16.3 Submodules

### 16.3.1 Overview

This section lists the configuration parameters of key submodules. For information on adjusting a specific parameter, e.g. synchronization source of PWM timer, please refer to Section 16.3.2 for details.

#### 16.3.1.1 Prescaler Submodule



Figure 16-2. Prescaler Submodule

Configuration parameter:

- Scale the PWM clock according to CLK\_160M.

#### 16.3.1.2 Timer Submodule

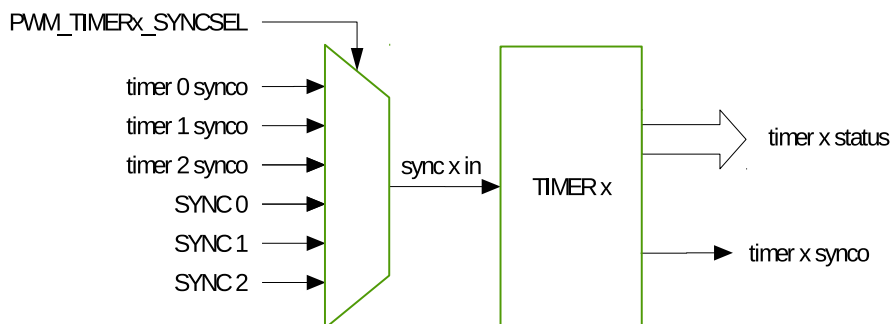


Figure 16-3. Timer Submodule

Configuration parameters:

- Set the PWM timer frequency or period.
- Configure the working mode for the timer:
  - Count-Up Mode: for asymmetric PWM outputs
  - Count-Down Mode: for asymmetric PWM outputs
  - Count-Up-Down Mode: for symmetric PWM outputs
- Configure the the reloading phase (including the value and the phase) used during software and hardware synchronization.

- Synchronize the PWM timers with each other. Either hardware or software synchronization may be used.
- Configure the source of the PWM timer's the synchronization input to one of the seven sources below:
  - The three PWM timer's synchronization outputs.
  - Three synchronization signals from the GPIO matrix: SYNC0, SYNC1, SYNC2.
  - No synchronization input signal selected
- Configure the source of the PWM timer's synchronization output to one of the four sources below:
  - Synchronization input signal
  - Event generated when value of the PWM timer is equal to zero
  - Event generated when value of the PWM timer is equal to period
  - No synchronization output generated
- Configure the method of period updating.

### 16.3.1.3 Operator Submodule

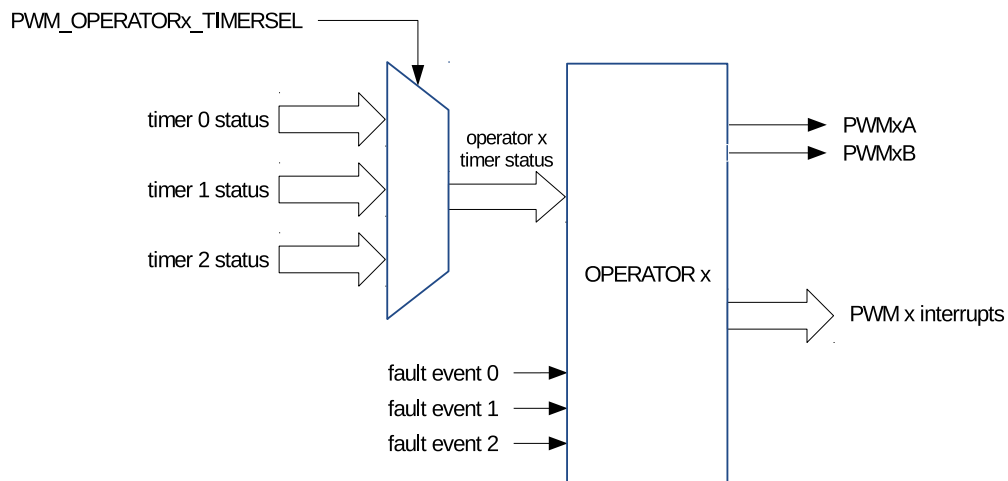


Figure 16-4. Operator Submodule

The configuration parameters of the operator submodule are shown in Table 16-1.

**Table 16-1. Configuration Parameters of the Operator Submodule**

Submodule	Configuration Parameter or Option
PWM Generator	<ul style="list-style-type: none"> <li>• Set up the PWM duty cycle for PWMxA and/or PWMxB output.</li> <li>• Set up at which time the timing events occur.</li> <li>• Define what action should be taken on timing events: <ul style="list-style-type: none"> <li>– Switch high or low PWMxA and/or PWMxB outputs</li> <li>– Toggle PWMxA and/or PWMxB outputs</li> <li>– Take no action on outputs</li> </ul> </li> <li>• Use direct s/w control to force the state of PWM outputs</li> <li>• Add a dead time to raising and / or falling edge on PWM outputs.</li> <li>• Configure update method for this submodule.</li> </ul>
Dead Time Generator	<ul style="list-style-type: none"> <li>• Control of complementary dead time relationship between upper and lower switches.</li> <li>• Specify the dead time on rising edge.</li> <li>• Specify the dead time on falling edge.</li> <li>• Bypass the dead time generator module. The PWM waveform will pass through without inserting dead time.</li> <li>• Allow PWMxB phase shifting with respect to the PWMxA output.</li> <li>• Configure updating method for this submodule.</li> </ul>
PWM Carrier	<ul style="list-style-type: none"> <li>• Enable carrier and set up carrier frequency.</li> <li>• Configure duration of the first pulse in the carrier waveform.</li> <li>• Set up the duty cycle of the following pulses.</li> <li>• Bypass the PWM carrier module. The PWM waveform will be passed through without modification.</li> </ul>
Fault Handler	<ul style="list-style-type: none"> <li>• Configure if and how the PWM module should react the fault event signals.</li> <li>• Specify the action taken when a fault event occurs: <ul style="list-style-type: none"> <li>– Force PWMxA and/or PWMxB high.</li> <li>– Force PWMxA and/or PWMxB low.</li> <li>– Configure PWMxA and/or PWMxB to ignore any fault event.</li> </ul> </li> <li>• Configure how often the PWM should react to fault events: <ul style="list-style-type: none"> <li>– One-shot</li> <li>– Cycle-by-cycle</li> </ul> </li> <li>• Generate interrupts.</li> <li>• Bypass the fault handler submodule entirely.</li> <li>• Set up an option for cycle-by-cycle actions clearing.</li> <li>• If desired, independently-configured actions can be taken when time-base counter is counting down or up.</li> </ul>



### 16.3.1.4 Fault Detection Submodule

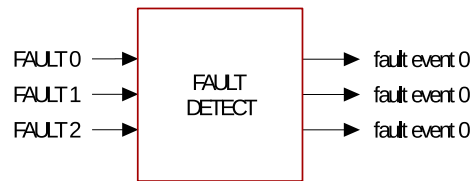


Figure 16-5. Fault Detection Submodule

Configuration parameters:

- Enable fault event generation and configure the polarity of fault event generation for every fault signal
- Generate fault event interrupts

### 16.3.1.5 Capture Submodule

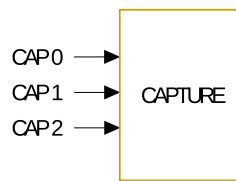


Figure 16-6. Capture Submodule

Configuration parameters:

- Select the edge polarity and prescaling of the capture input.
- Set up a software-triggered capture.
- Configure the capture timer's sync trigger and sync phase.
- Software syncs the capture timer.

## 16.3.2 PWM Timer Submodule

Each MCPWM module has three PWM timer submodules. Any of them can determine the necessary event timing for any of the three PWM operator submodules. Built-in synchronization logic allows multiple PWM timer submodules, in one or more MCPWM modules, to work together as a system, when using synchronization signals from the GPIO matrix.

### 16.3.2.1 Configurations of the PWM Timer Submodule

Users can configure the following functions of the PWM timer submodule:

- Control how often events occur by specifying the PWM timer frequency or period.
- Configure a particular PWM timer to synchronize with other PWM timers or modules.

- Get a PWM timer in phase with other PWM timers or modules.
- Set one of the following timer counting modes: count-up, count-down, count-up-down.
- Change the rate of the PWM timer clock (PT\_clk) with a prescaler. Each timer has its own prescaler configured with PWM\_TIMER $x$ \_PRESCALE of register [PWM\\_TIMER0\\_CFG0\\_REG](#). The PWM timer increments or decrements at a slower pace, depending on the setting of this register.

### 16.3.2.2 PWM Timer's Working Modes and Timing Event Generation

The PWM timer has three working modes, selected by the PWM $x$  timer mode register:

- **Count-Up Mode:**  
In this mode, the PWM timer increments from zero until reaching the value configured in the period register. Once done, the PWM timer returns to zero and starts increasing again. PWM period is equal to the value of period register + 1.  
Note: The period register is PWM\_TIMER $x$ \_PERIOD ( $x = 0, 1, 2$ ), i.e., [PWM\\_TIMER0\\_PERIOD](#), [PWM\\_TIMER1\\_PERIOD](#), [PWM\\_TIMER2\\_PERIOD](#).
- **Count-Down Mode:**  
The PWM timer decrements to zero, starting from the value configured in the period register. After reaching zero, it is set back to the period value. Then it starts to decrement again. In this case, the PWM period is also equal to the value of period register + 1.
- **Count-Up-Down Mode:**  
This is a combination of the two modes mentioned above. The PWM timer starts increasing from zero until the period value is reached. Then, the timer decreases back to zero. This pattern is then repeated. The PWM period is the result of (the value of period register  $\times 2 + 1$ ).

Figures 16-7 to 16-10 show PWM timer waveforms in different modes, including timer behavior during synchronization events.

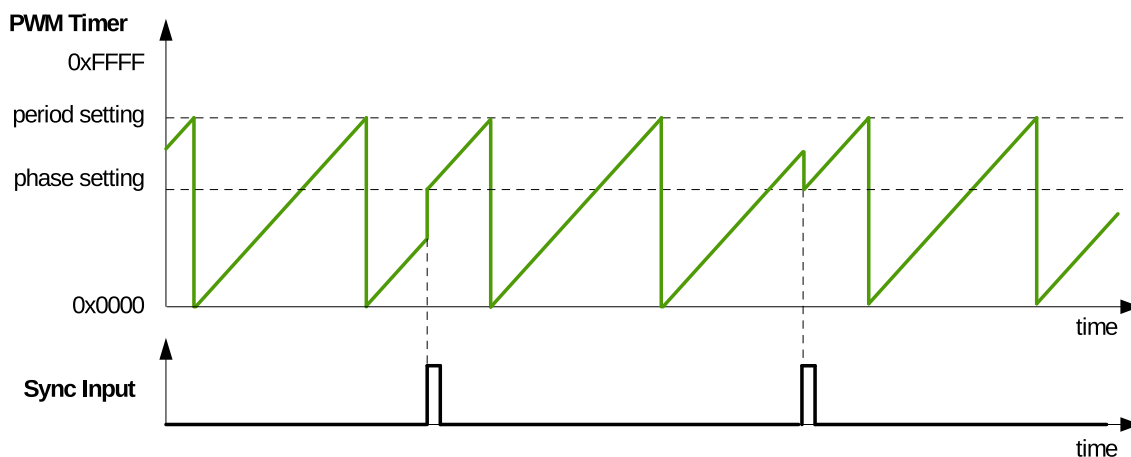


Figure 16-7. Count-Up Mode Waveform

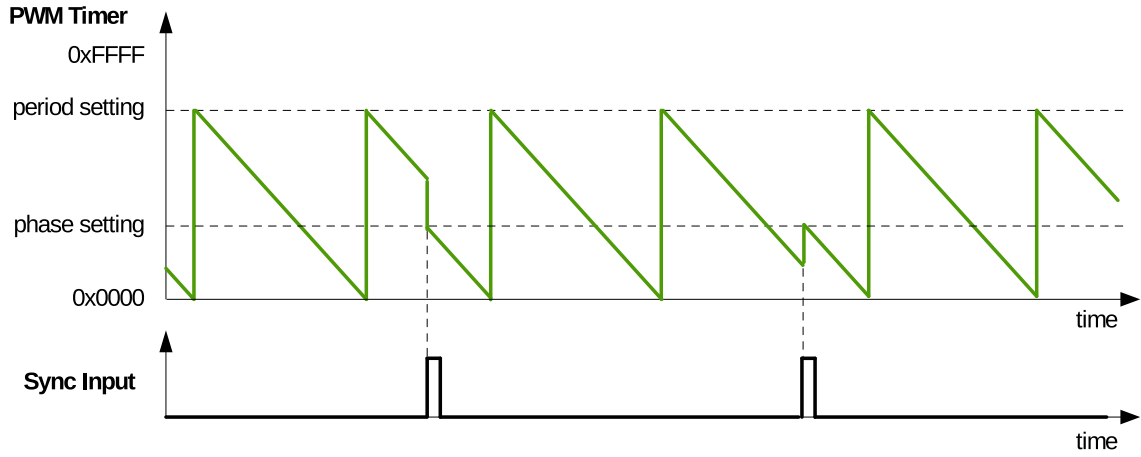


Figure 16-8. Count-Down Mode Waveforms

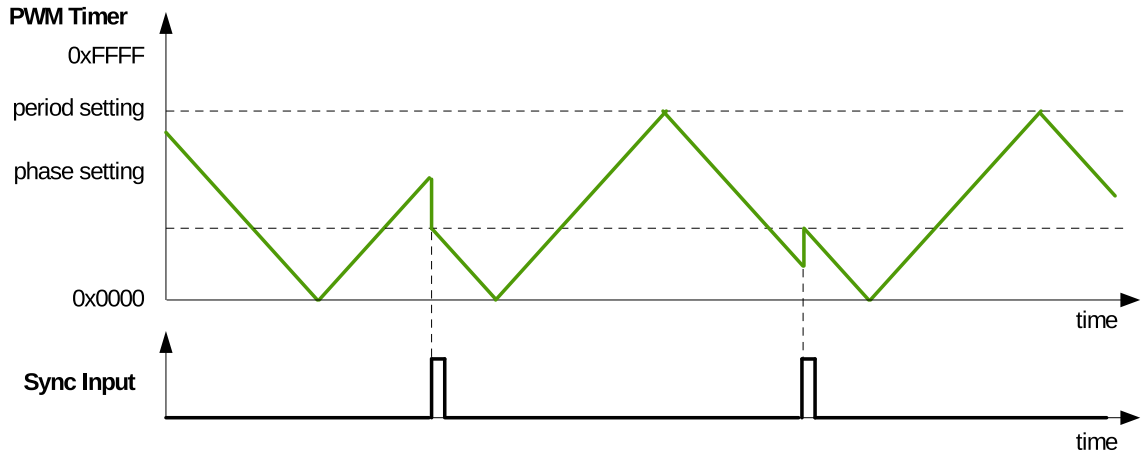


Figure 16-9. Count-Up-Down Mode Waveforms, Count-Down at Synchronization Event

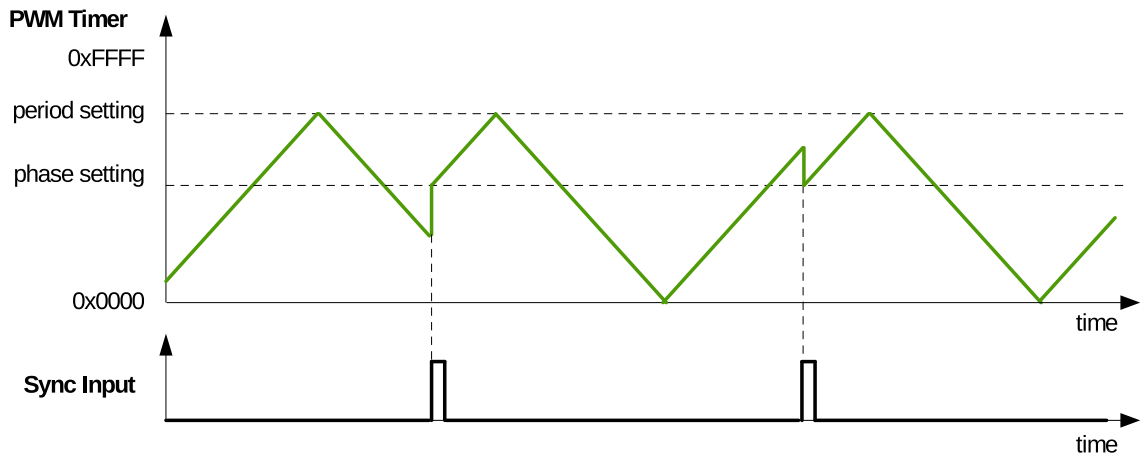


Figure 16-10. Count-Up-Down Mode Waveforms, Count-Up at Synchronization Event

When the PWM timer is running, it generates the following timing events periodically and automatically:

- UTEP  
The timing event generated when the PWM timer's value equals to the value of the period register (PWM\_TIMER<sub>x</sub>\_PERIOD) and when the PWM timer is increasing.
- UTEZ  
The timing event generated when the PWM timer's value equals to zero and when the PWM timer is increasing.
- DTEP  
The timing event generated when the PWM timer's value equals to the value of the period register (PWM\_TIMER<sub>x</sub>\_PERIOD) and when the PWM timer is decreasing.
- DTEZ  
The timing event generated when the PWM timer's value equals to zero and when the PWM timer is decreasing.

Figures 16-11 to 16-13 show the timing waveforms of U/DTEP and U/DTEZ.

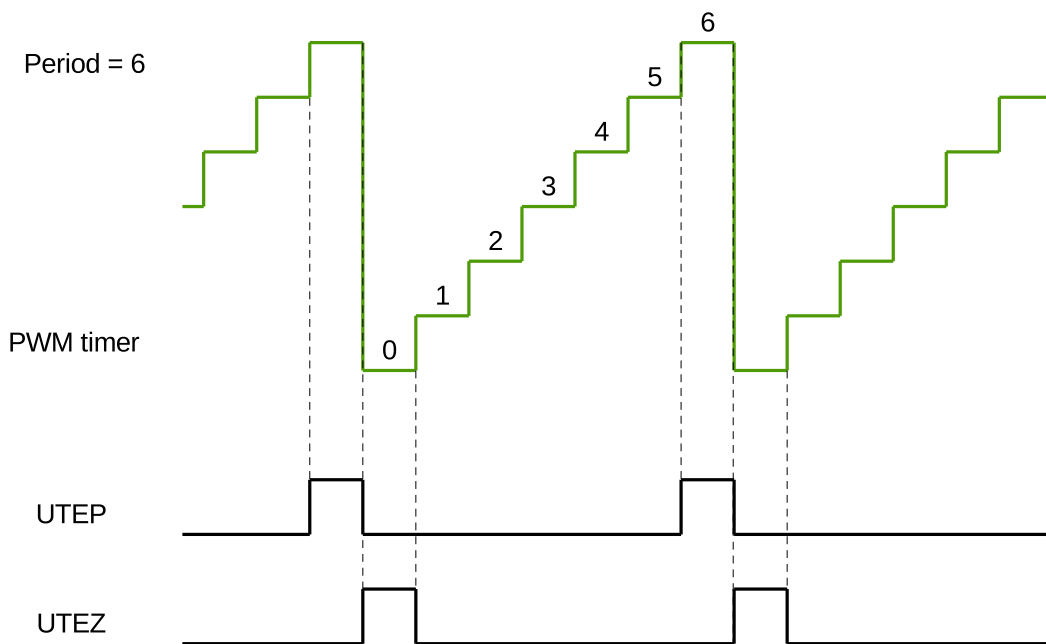


Figure 16-11. UTEP and UTEZ Generation in Count-Up Mode

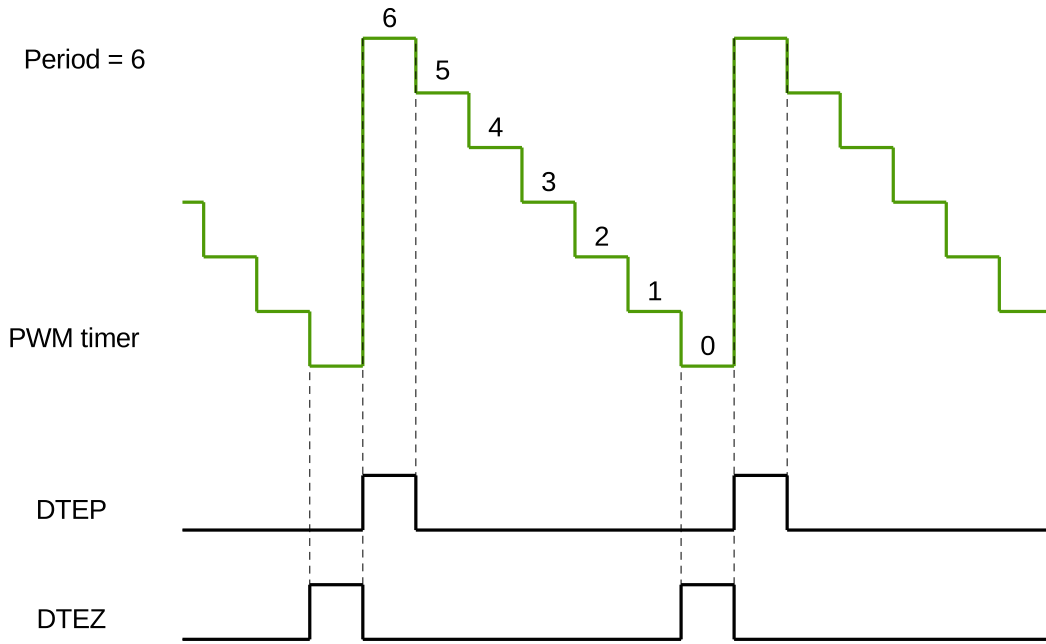


Figure 16-12. DTEP and DTEZ Generation in Count-Down Mode

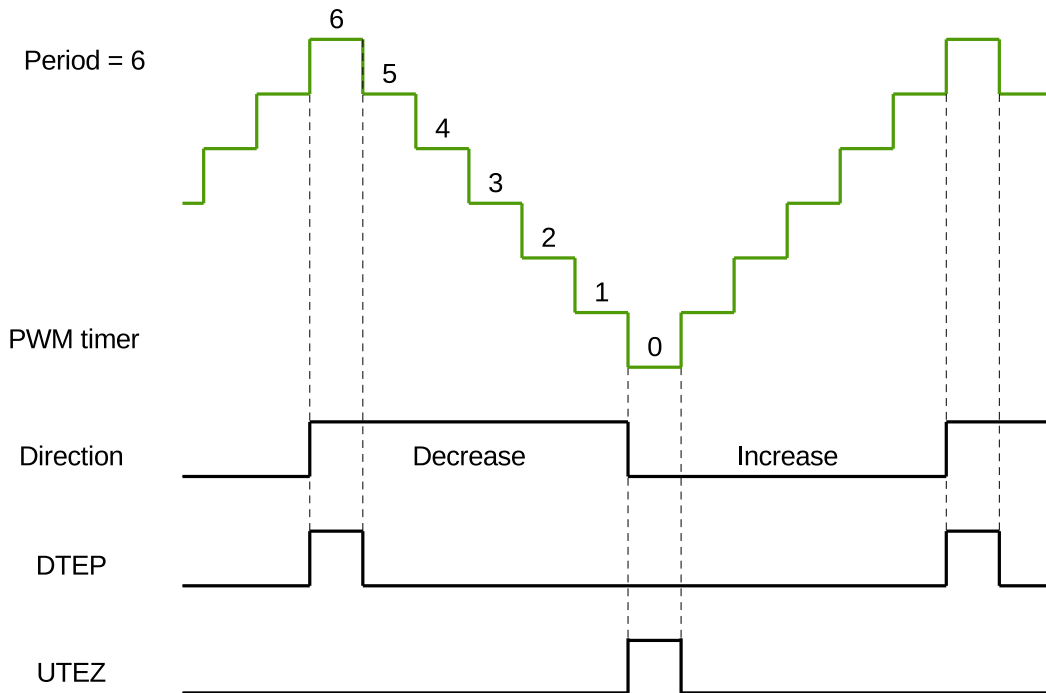


Figure 16-13. DTEP and UTEZ Generation in Count-Up-Down Mode

### 16.3.2.3 PWM Timer Shadow Register

The PWM timer's period register and the PWM timer's clock prescaler register have shadow registers. The purpose of a shadow register is to save a copy of the value to be written into the active register at a specific moment synchronized with the hardware. Both register types are defined as follows:

- Active Register

This register is directly responsible for controlling all actions performed by hardware.

- Shadow Register

It acts as a temporary buffer for a value to be written on the active register. Before this happens, the content of the shadow register has no direct effect on the controlled hardware. At a specific, user-configured point in time, the value saved in the shadow register is copied to the active register. This helps to prevent spurious operation of the hardware, which may happen when a register is asynchronously modified by software. Both the shadow register and the active register have the same memory address. The software always writes into, or reads from the shadow register. The moment of updating the active register is determined by its specific update method register. The update can start when the PWM timer is equal to zero, when the PWM timer is equal to period, at a synchronization moment, or immediately. Software can trigger a globally forced update which will prompt all registers in the module to be updated according to shadow registers.

### 16.3.2.4 PWM Timer Synchronization and Phase Locking

The PWM modules adopt a flexible synchronization method. Each PWM timer has a synchronization input and a synchronization output. The synchronization input can be selected from three synchronization outputs and three synchronization signals from the GPIO matrix. The synchronization output can be generated from the synchronization input signal, or when the PWM timer's value is equal to period or zero. Thus, the PWM timers can be chained together with their phase locked. During synchronization, the PWM timer clock prescaler will reset its counter in order to synchronize the PWM timer clock.

### 16.3.3 PWM Operator Submodule

The PWM Operator submodule has the following functions:

- Generates a PWM signal pair, based on timing references obtained from the corresponding PWM timer.
- Each signal out of the PWM signal pair includes a specific pattern of dead time.
- Superimposes a carrier on the PWM signal, if configured to do so.
- Handles response under fault conditions.

Figure 16-14 shows the block diagram of a PWM operator.

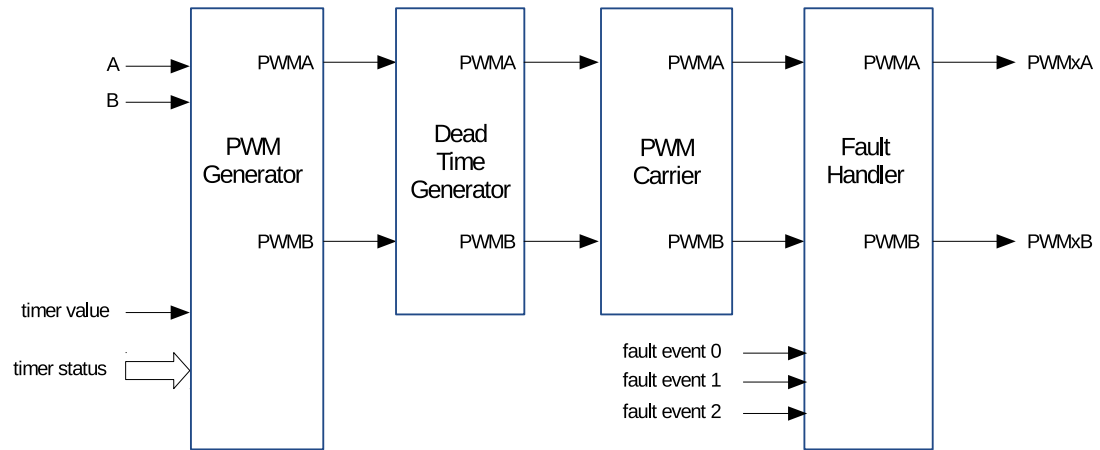


Figure 16-14. Submodules Inside the PWM Operator

### 16.3.3.1 PWM Generator Submodule

#### Purpose of the PWM Generator Submodule

In this submodule, important timing events are generated or imported. The events are then converted into specific actions to generate the desired waveforms at the PWMxA and PWMxB outputs.

The PWM generator submodule performs the following actions:

- Generation of timing events based on time stamps configured using the A and B registers. Events happen when the following conditions are satisfied:
  - UTEA: the PWM timer is counting up and its value is equal to register A.
  - UTEB: the PWM timer is counting up and its value is equal to register B.
  - DTEA: the PWM timer is counting down and its value is equal to register A.
  - DTEB: the PWM timer is counting down and its value is equal to register B.
- Generation of U/DT1, U/DT2 timing events based on fault or synchronization events.
- Management of priority when these timing events occur concurrently.
- Qualification and generation of set, clear and toggle actions, based on the timing events.
- Controlling of the PWM duty cycle, depending on configuration of the PWM generator submodule.
- Handling of new time stamp values, using shadow, registers to prevent glitches in the PWM cycle.

#### PWM Operator Shadow Registers

The time stamp registers A and B, as well as action configuration registers `PWM_GENx_A_REG` and `PWM_GENx_B_REG` are shadowed. Shadowing provides a way of updating registers in sync with the hardware. For a description of the shadow registers, please see [16.3.2.3](#).

#### Timing Events

For convenience, all timing signals and events are summarized in [Table 16-2](#).

**Table 16-2. Timing Events Used in PWM Generator**

Signal	Event Description	PWM Timer Operation
DTEP	PWM timer value is equal to the period register value	PWM timer counts down.
DTEZ	PWM timer value is equal to zero	
DTEA	PWM timer value is equal to A register	
DTEB	PWM timer value is equal to B register	
DT0 event	Based on fault or synchronization events	
DT1 event	Based on fault or synchronization events	
UTEP	PWM timer value is equal to the period register value	PWM timer counts up.
UTEZ	PWM timer value is equal to zero	
UTEA	PWM timer value is equal to A register	
UTEB	PWM timer value is equal to B register	
UT0 event	Based on fault or synchronization events	
UT1 event	Based on fault or synchronization events	



Signal	Event Description	PWM Timer Operation
Software-force event	Software-initiated asynchronous event	N/A

The purpose of a software-force event is to impose non-continuous or continuous changes on the PWM<sub>x</sub>A and PWM<sub>x</sub>B outputs. The change is done asynchronously. Software-force control is handled by the `PWM_PWM_GENx_FORCE_REG` registers.

The selection and configuration of T0/T1 in the PWM generator submodule is independent of the configuration of fault events in the fault handler submodule. A particular trip event may or may not be configured to cause trip action in the fault handler submodule, but the same event can be used by the PWM generator to trigger T0/T1 for controlling PWM waveforms.

It is important to know that when the PWM timer is in count-up-down mode, it will always decrement after a TEP event, and will always increment after a TEZ event. So when the PWM timer is in count-up-down mode, DTEP and UTEZ events will occur, while the events UTEP and DTEZ will never occur.

The PWM generator can handle multiple events at the same time. Events are prioritized by the hardware and relevant details are provided in Table 16-3 and Table 16-4. Priority levels range from 1 (the highest) to 7 (the lowest). Please note that the priority of TEP and TEZ events depends on the PWM timer's direction.

If the value of A or B is set to be greater than the period, then U/DTEA and U/DTEB will never occur.

**Table 16-3. Timing Events Priority When PWM Timer Increments**

Priority Level	Event
1 (highest)	Software-force event
2	UTEP
3	UT0
4	UT1
5	UTEB
6	UTEA
7 (lowest)	UTEZ

**Table 16-4. Timing Events Priority when PWM Timer Decrements**

Priority level	Event
1 (highest)	Software-force event
2	DTEZ
3	DT0
4	DT1
5	DTEB
6	DTEA
7 (lowest)	DTEP

Notes:

1. UTEP and UTEZ do not happen simultaneously. When the PWM timer is in count-up mode, UTEP will always happen one cycle earlier than UTEZ, as demonstrated in Figure 16-11, so their action on PWM signals will

not interrupt each other. When the PWM timer is in count-up-down mode, UTEP will not occur.

2. DTEP and DTEZ do not happen simultaneously. When the PWM timer is in count-down mode, DTEZ will always happen one cycle earlier than DTEP, as demonstrated in Figure 16-12, so their action on PWM signals will not interrupt each other. When the PWM timer is in count-up-down mode, DTEZ will not occur.

## PWM Signal Generation

The PWM generator submodule controls the behavior of outputs PWMxA and PWMxB when a particular timing event occurs. The timing events are further qualified by the PWM timer's counting direction (up or down). Knowing the counting direction, the submodule may then perform an independent action at each stage of the PWM timer counting up or down.

The following actions may be configured on outputs PWMxA and PWMxB:

- Set High:  
Set the output of PWMxA or PWMxB to a high level.
- Clear Low:  
Clear the output of PWMxA or PWMxB by setting it to a low level.
- Toggle:  
Change the current output level of PWMxA or PWMxB to the opposite value. If it is currently pulled high, pull it low, or vice versa.
- Do Nothing:  
Keep both outputs PWMxA and PWMxB unchanged. In this state, interrupts can still be triggered.

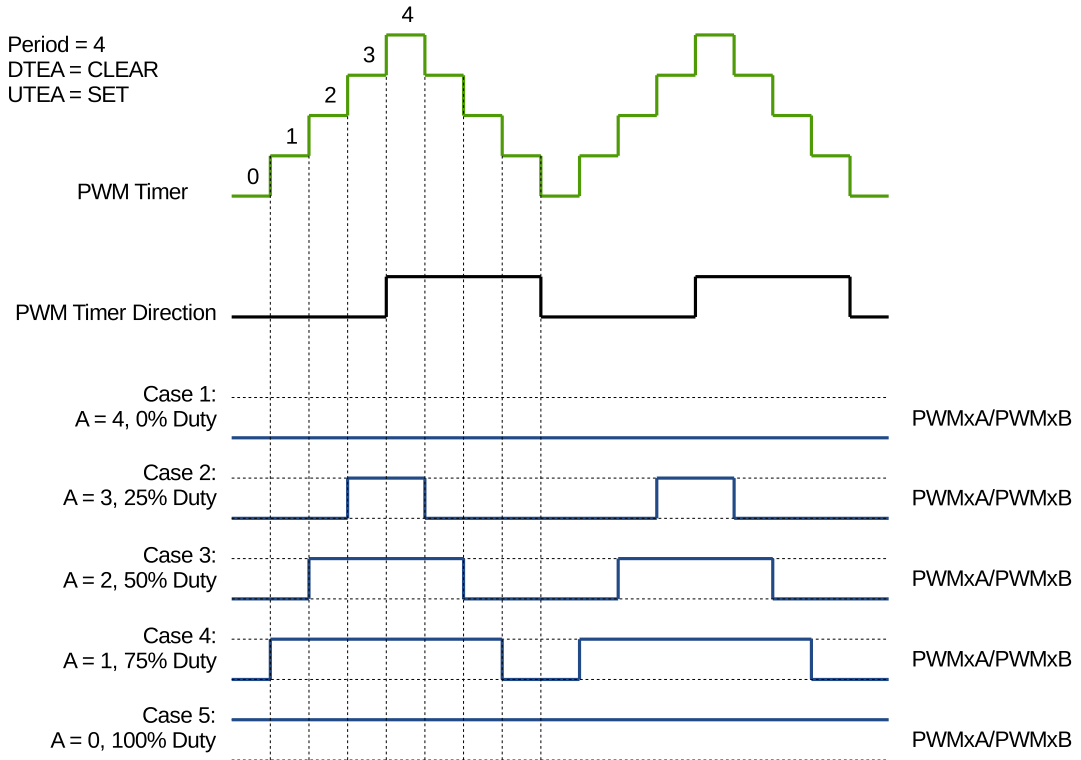
The configuration of actions on outputs is done by using registers `PWN_GENx_A_REG` and `PWN_GENx_B_REG`. So, the action to be taken on each output is set independently. Also there is great flexibility in selecting actions to be taken on a given output based on events. More specifically, any event listed in Table 16-2 can operate on either output PWMxA or PWMxB. To check out registers for particular generator 0, 1 or 2, please refer to register description in Section 16.4.

## Waveforms for Common Configurations

Figure 16-15 presents the symmetric PWM waveform generated when the PWM timer is counting up and down. DC 0%–100% modulation can be calculated via the formula below:

$$Duty = (Period - A) \div Period$$

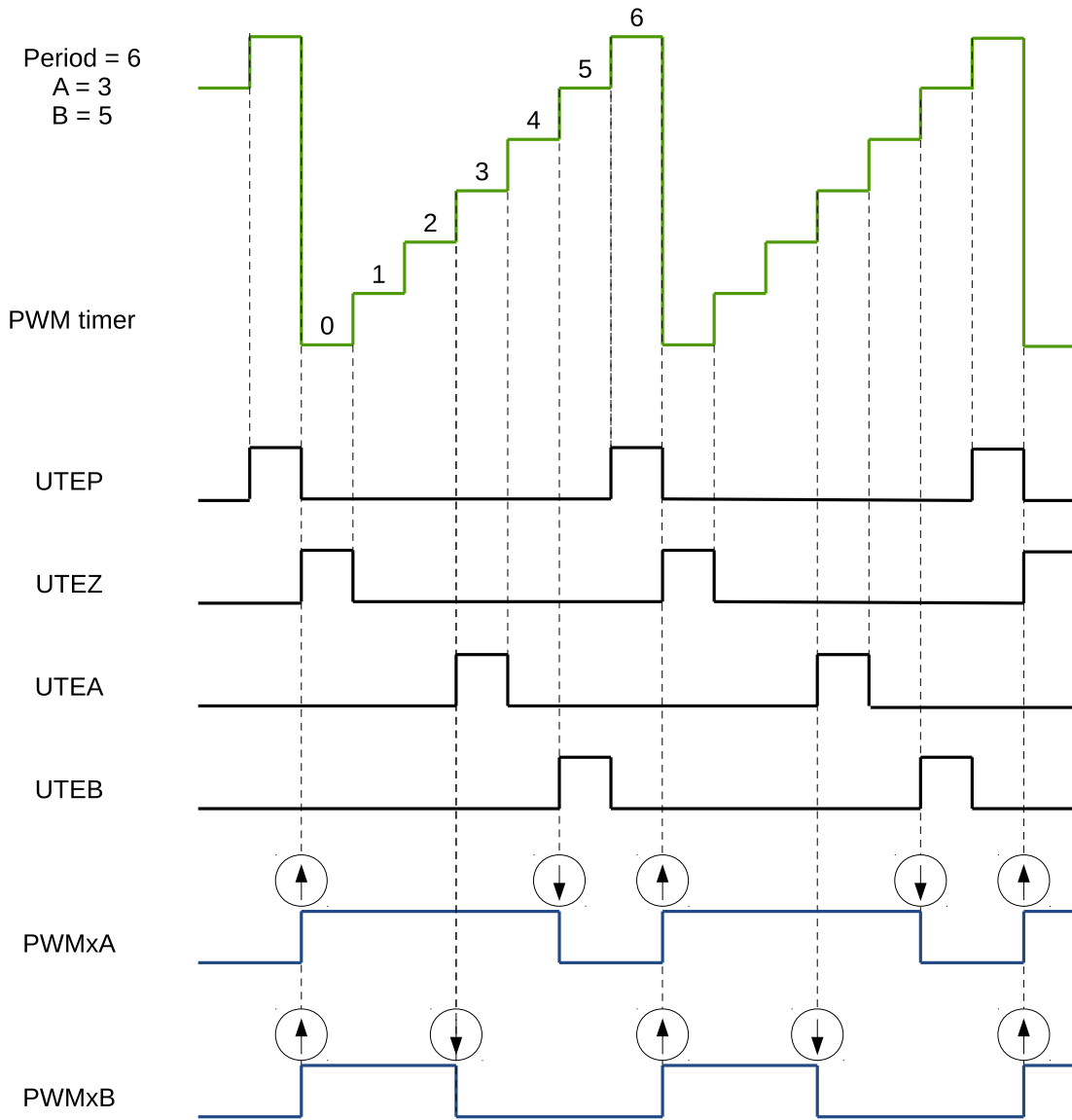
If A matches the PWM timer value and the PWM timer is incrementing, then the PWM output is pulled up. If A matches the PWM timer value while the PWM timer is decrementing, then the PWM output is pulled low.



**Figure 16-15. Symmetrical Waveform in Count-Up-Down Mode**

The PWM waveforms in Figures 16-16 to 16-19 show some common PWM operator configurations. The following conventions are used in the figures:

- Period A and B refer to the values written in the corresponding registers.
- PWMxA and PWMxB are the output signals of PWM Operator x.

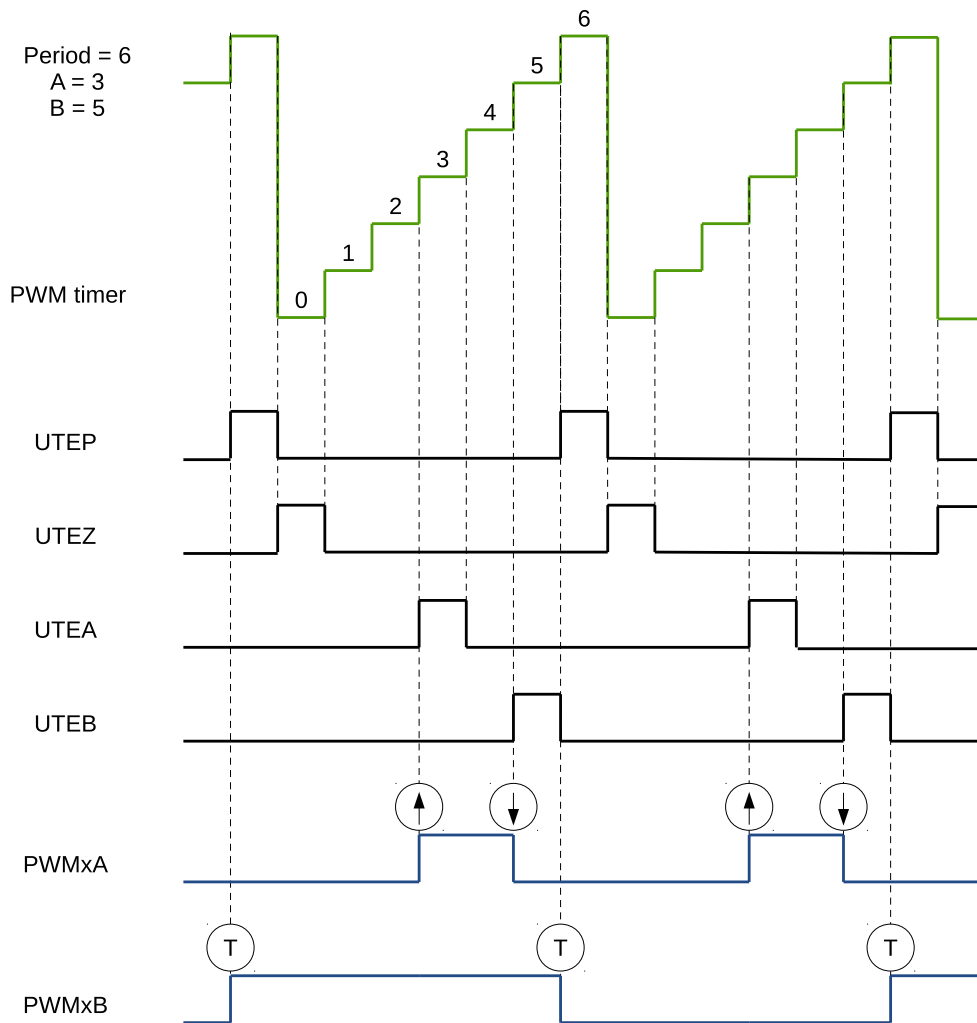


**Figure 16-16. Count-Up, Single Edge Asymmetric Waveform, with Independent Modulation on PWMxA and PWMxB – Active High**

The duty modulation for PWMxA is set by B, active high and proportional to B.

The duty modulation for PWMxB is set by A, active high and proportional to A.

$$Period = (PWM\_TIMER\_PERIOD + 1) \times T_{PT\_clk}$$

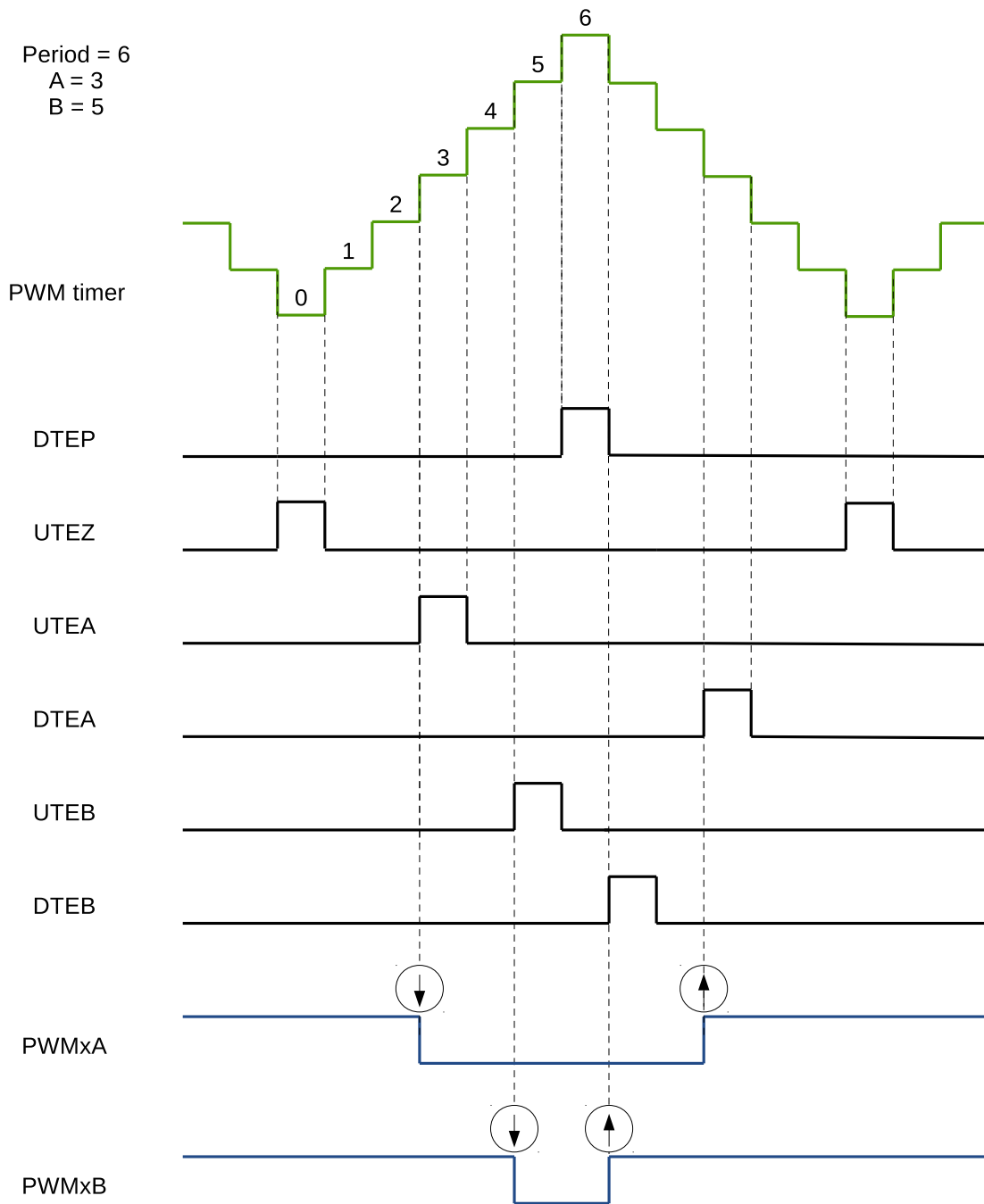


**Figure 16-17. Count-Up, Pulse Placement Asymmetric Waveform with Independent Modulation on PWMxA**

Pulses may be generated anywhere within the PWM cycle (zero – period).

PWMxA's high time duty is proportional to (B – A).

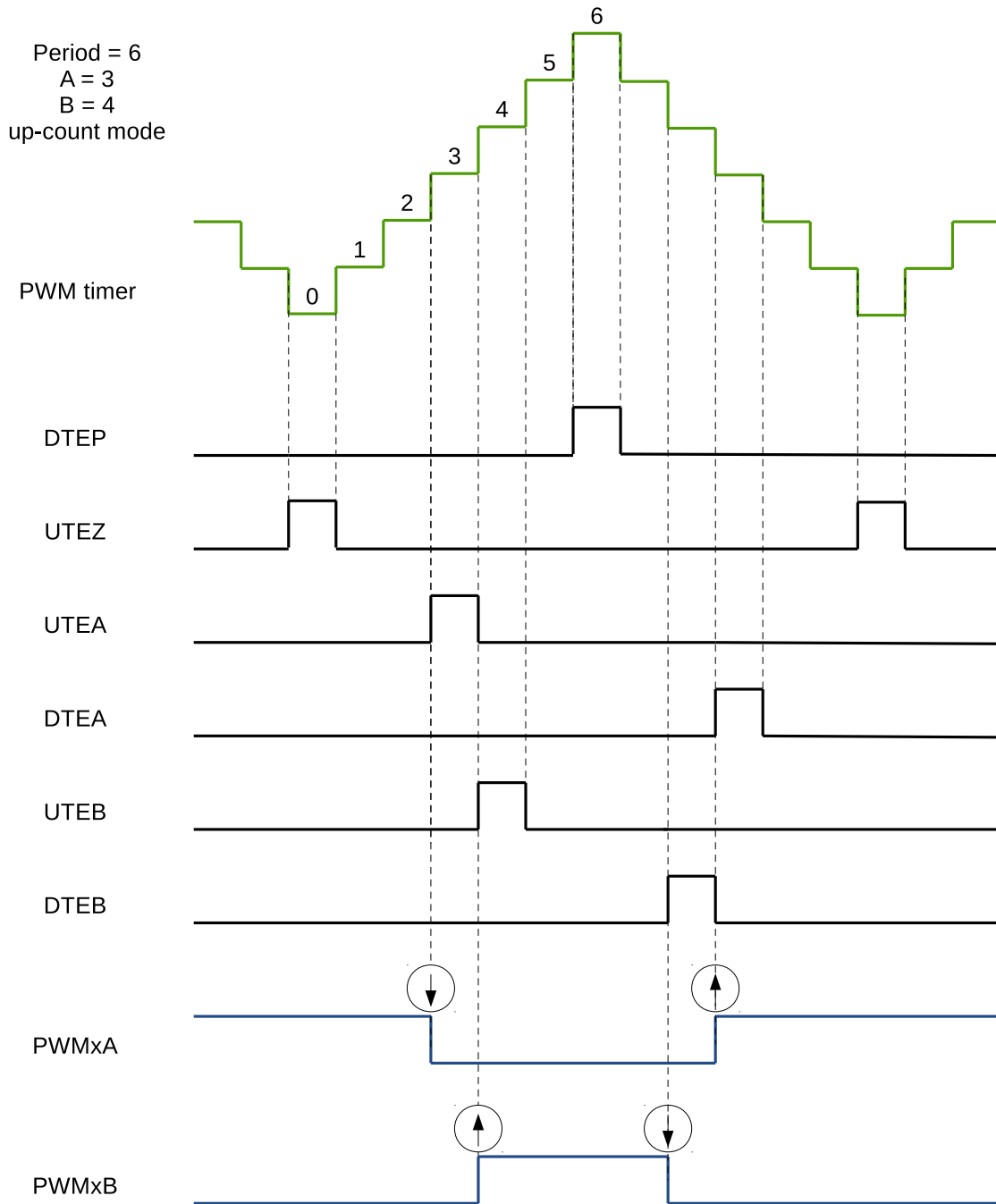
$$Period = (PWM\_TIMERx\_PERIOD + 1) \times T_{PT\_clk}$$



**Figure 16-18. Count-Up-Down, Dual Edge Symmetric Waveform, with Independent Modulation on PWMxA and PWMxB – Active High**

The duty modulation for PWMxA is set by A, active high and proportional to A.  
The duty modulation for PWMxB is set by B, active high and proportional to B.  
Outputs PWMxA and PWMxB can drive independent switches.

$$Period = (2 \times PWM\_TIMER\_PERIOD + 1) \times T_{PT\_clk}$$



**Figure 16-19. Count-Up-Down, Dual Edge Symmetric Waveform, with Independent Modulation on PWMxA and PWMxB – Complementary**

The duty modulation of PWMxA is set by A, is active high and proportional to A.

The duty modulation of PWMxB is set by B, is active low and proportional to B.

Outputs PWMx can drive upper/lower (complementary) switches.

Dead-time = B – A; Edge placement is fully programmable by software. Use the dead-time generator module if another edge delay method is required.

$$Period = (2 \times PWM\_TIMER\_PERIOD + 1) \times T_{PT\_clk}$$

## Software-Force Events

There are two types of software-force events inside the PWM generator:

- Non-continuous-immediate (NCI) software-force events  
Such types of events are immediately effective on PWM outputs when triggered by software. The forcing is non-continuous, meaning the next active timing events will be able to alter the PWM outputs.
- Continuous (CNTU) software-force events  
Such types of events are continuous. The forced PWM outputs will continue until they are released by software. The events' triggers are configurable. They can be timing events or immediate events.

Figure 16-20 shows a waveform of NCI software-force events. NCI events are used to force PWMxA output low. Forcing on PWMxB is disabled in this case.

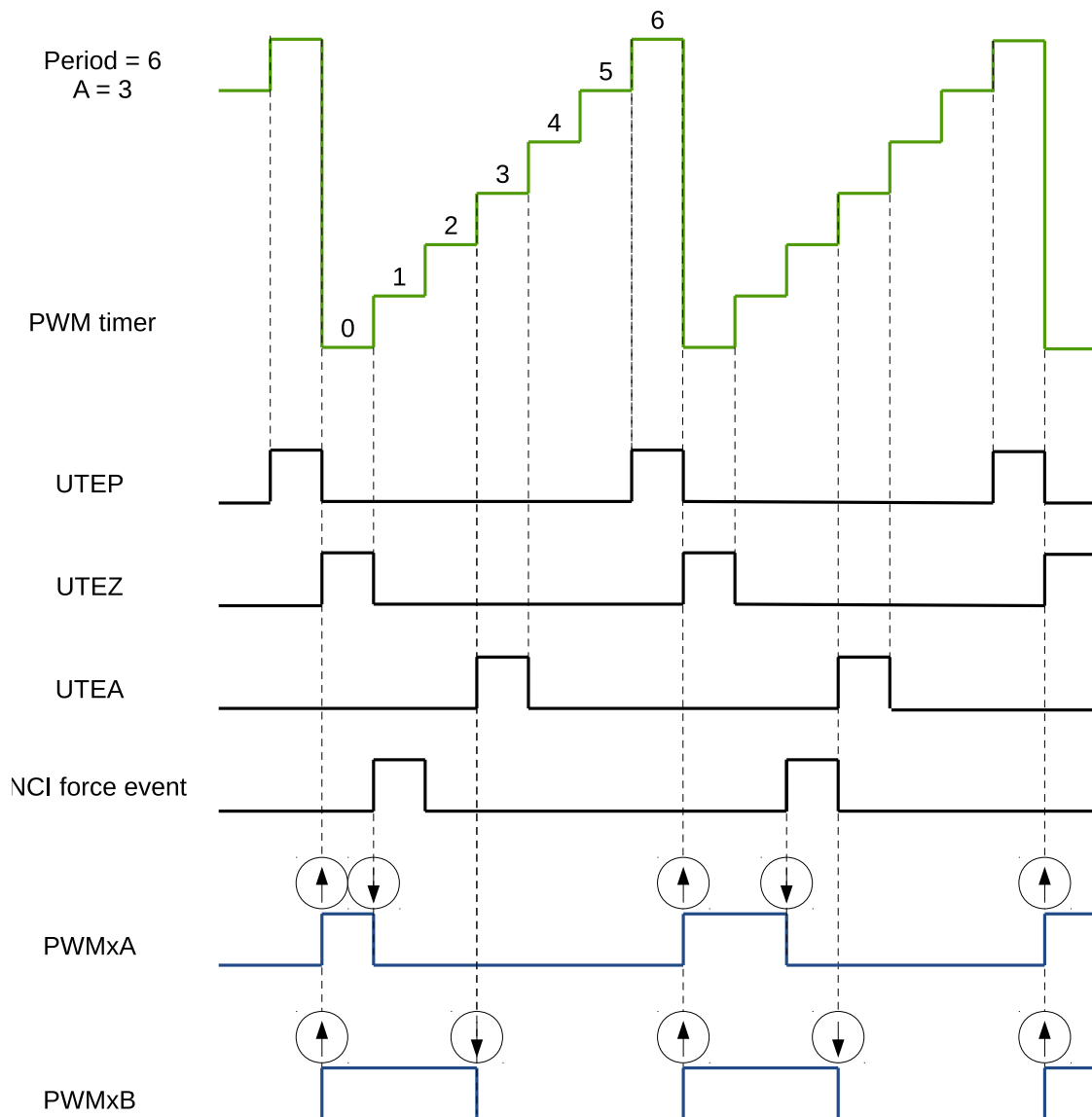


Figure 16-20. Example of an NCI Software-Force Event on PWMxA



Figure 16-21 shows a waveform of CNTU software-force events. UTEZ events are selected as triggers for CNTU software-force events. CNTU is used to force the PWMxB output low. Forcing on PWMxA is disabled.

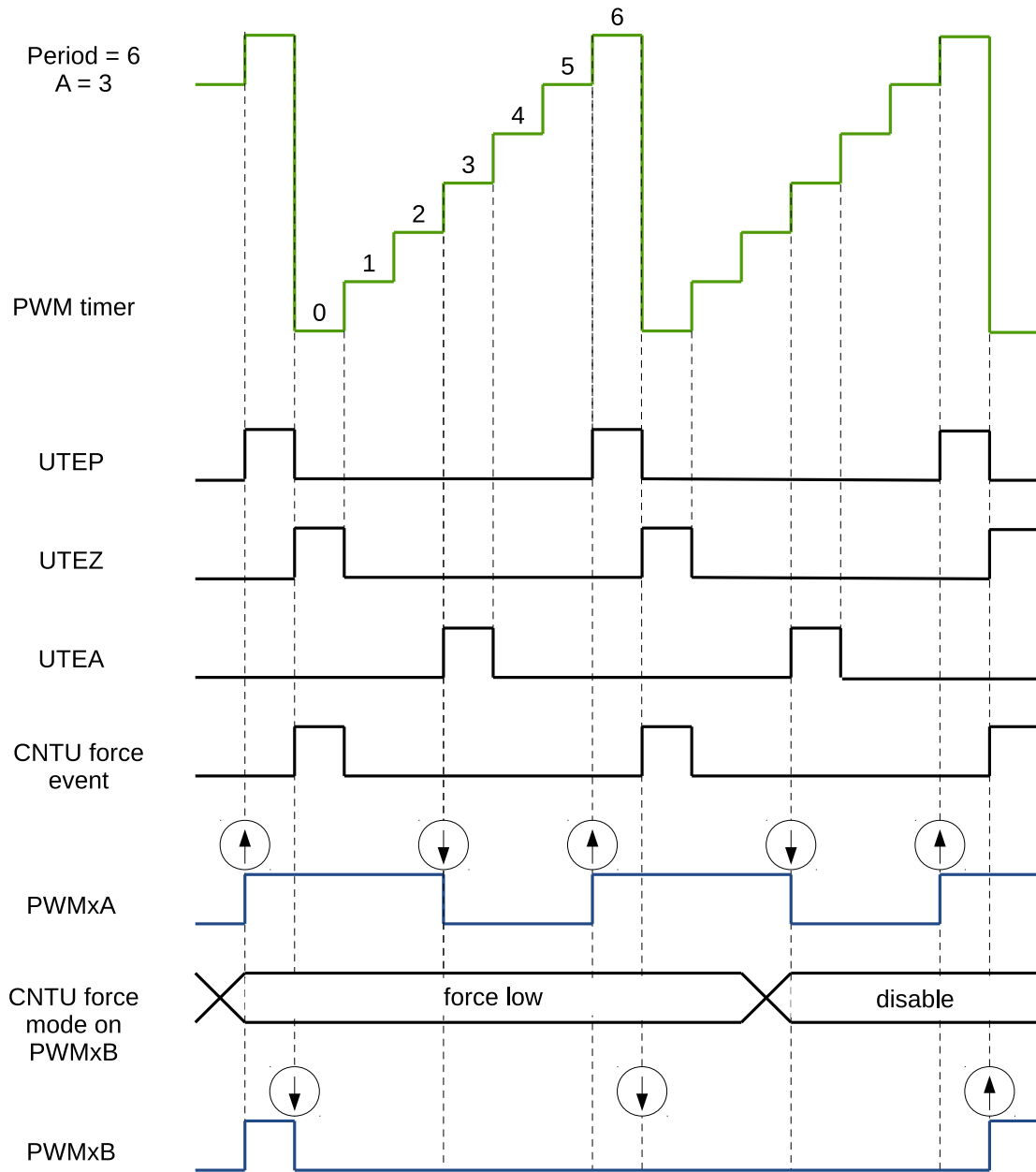


Figure 16-21. Example of a CNTU Software-Force Event on PWMxB

### 16.3.3.2 Dead Time Generator Submodule

#### Purpose of the Dead Time Generator Submodule

Several options to generate signals on PWMxA and PWMxB outputs, with a specific placement of signal edges, have been discussed in section 16.3.3.1. The required dead time is obtained by altering the edge placement between signals and by setting the signal's duty cycle. Another option is to control the dead time using a specialized submodule – the Dead Time Generator.

The key functions of the dead time generator submodule are as follows:

- Generating signal pairs (PWMxA and PWMxB) with a dead time from a single PWMxA input
- Creating a dead time by adding delay to signal edges:
  - Rising edge delay (RED)
  - Falling edge delay (FED)
- Configuring the signal pairs to be:
  - Active high complementary (AHC)
  - Active low complementary (ALC)
  - Active high (AH)
  - Active low (AL)
- This submodule may also be bypassed, if the dead time is configured directly in the generator submodule.

#### Dead Time Generator's Shadow Registers

Delay registers RED and FED are shadowed with registers [PWM\\_DT<sub>x</sub>\\_RED\\_CFG\\_REG](#) and [PWM\\_DT<sub>x</sub>\\_FED\\_CFG\\_REG](#). For the description of shadow registers, please see section 16.3.2.3.

### Highlights for Operation of the Dead Time Generator

Options for setting up the dead-time submodule are shown in Figure 16-22.

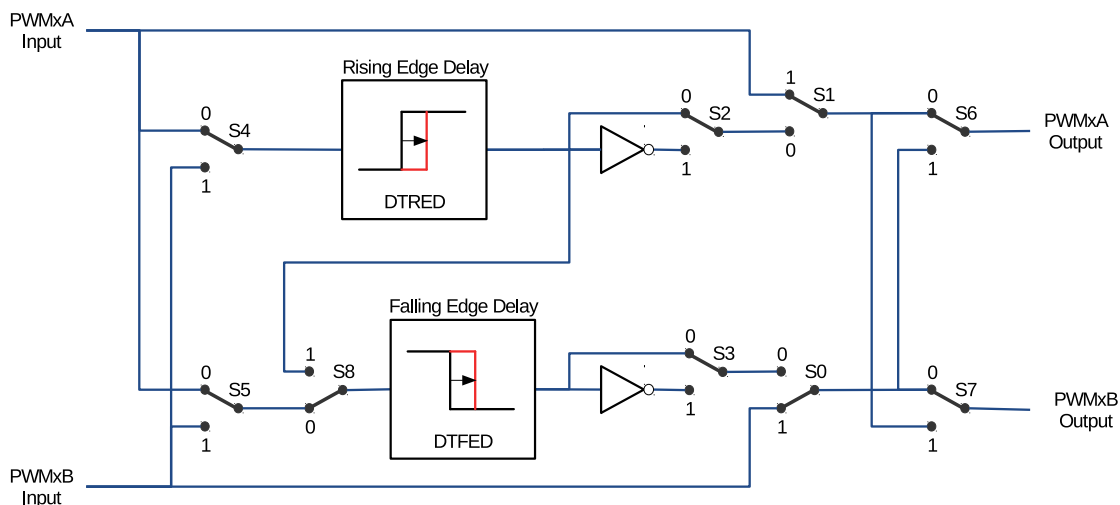


Figure 16-22. Options for Setting up the Dead Time Generator Submodule

S0-8 in the figure above are switches controlled by registers PWM\_DT<sub>x</sub>\_CFG\_REG shown in Table 16-5.

Table 16-5. Dead Time Generator Switches Control Registers

Switch	Register
S0	PWM_DT <sub>x</sub> _B_OUTBYPASS
S1	PWM_DT <sub>x</sub> _A_OUTBYPASS
S2	PWM_DT <sub>x</sub> _RED_OUTINVERT
S3	PWM_DT <sub>x</sub> _FED_OUTINVERT
S4	PWM_DT <sub>x</sub> _RED_INSEL
S5	PWM_DT <sub>x</sub> _FED_INSEL
S6	PWM_DT <sub>x</sub> _A_OUTSWAP
S7	PWM_DT <sub>x</sub> _B_OUTSWAP
S8	PWM_DT <sub>x</sub> _DEB_MODE

All switch combinations are supported, but not all of them represent the typical modes of use. Table 16-6 documents some typical dead time configurations. In these configurations the position of S4 and S5 sets PWMxA as the common source of both falling-edge and rising-edge delay. The modes presented in table 16-6 may be categorized as follows:

- Mode 1: Bypass delays on both falling (FED) as well as raising edge (RED)**  
 In this mode the dead time submodule is disabled. Signals PWMxA and PWMxB pass through without any modifications.
- Mode 2-5: Classical Dead Time Polarity Settings**  
 These modes represent typical configurations of polarity and should cover the active-high/low modes in available industry power switch gate drivers. The typical waveforms are shown in Figures 16-23 to 16-26.

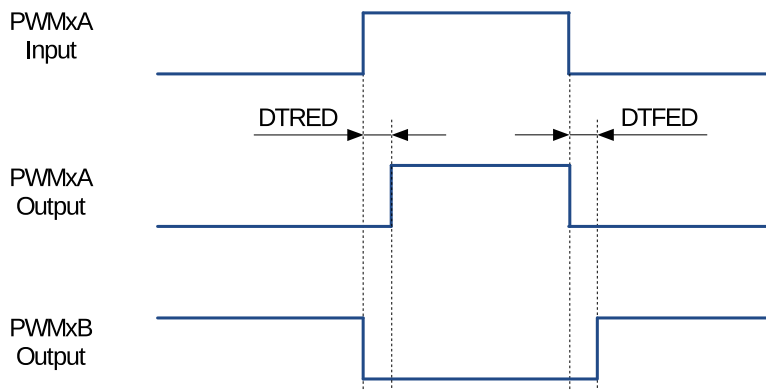
- **Modes 6 and 7: Bypass delay on falling edge (FED) or rising edge (RED)**

In these modes, either RED (Rising Edge Delay) or FED (Falling Edge Delay) is bypassed. As a result, the corresponding delay is not applied.

**Table 16-6. Typical Dead Time Generator Operating Modes**

Mode	Mode Description	S0	S1	S2	S3
1	PWMxA and PWMxB Pass Through/No Delay	1	1	X	X
2	Active High Complementary (AHC), see Figure 16-23	0	0	0	1
3	Active Low Complementary (ALC), see Figure 16-24	0	0	1	0
4	Active High (AH), see Figure 16-25	0	0	0	0
5	Active Low (AL), see Figure 16-26	0	0	1	1
6	PWMxA Output = PWMxA In (No Delay) PWMxB Output = PWMxA Input with Falling Edge Delay	0	1	0 or 1	0 or 1
7	PWMxA Output = PWMxA Input with Rising Edge Delay PWMxB Output = PWMxB Input with No Delay	1	0	0 or 1	0 or 1

Note: For all the modes above, the position of the binary switches S4 to S8 is set to 0.



**Figure 16-23. Active High Complementary (AHC) Dead Time Waveforms**

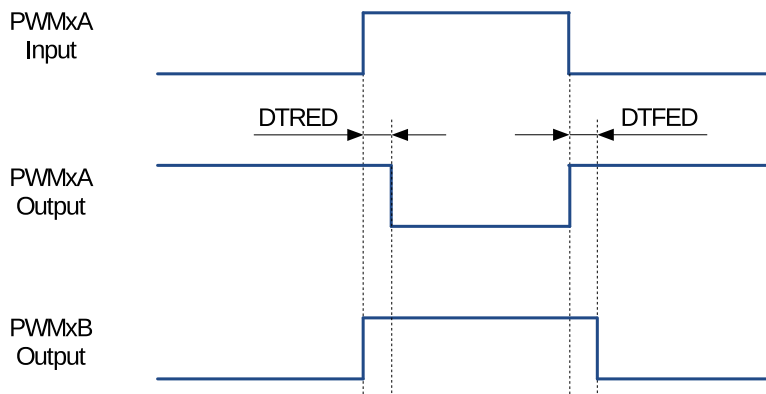


Figure 16-24. Active Low Complementary (ALC) Dead Time Waveforms

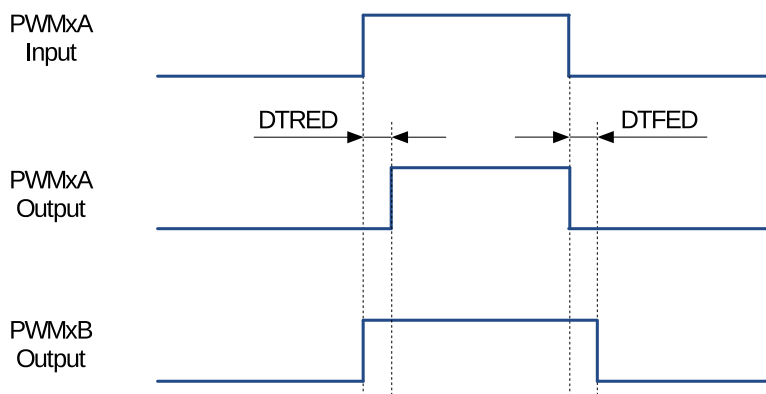
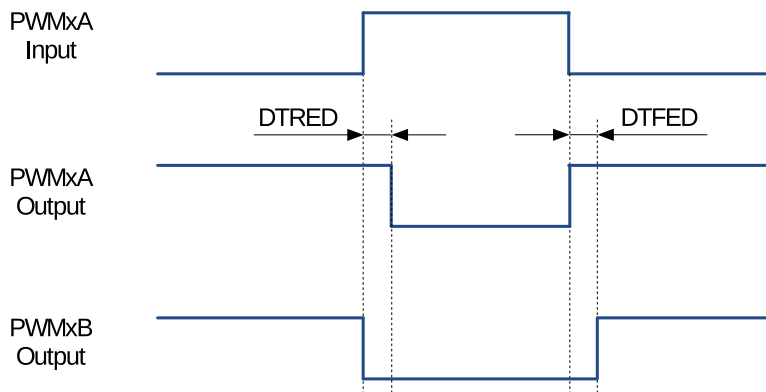


Figure 16-25. Active High (AH) Dead Time Waveforms



**Figure 16-26. Active Low (AL) Dead Time Waveforms**

Rising edge (RED) and falling edge (FED) delays may be set up independently. The delay value is programmed using the 16-bit registers `PWM_DT $\times$ _RED` and `PWM_DT $\times$ _FED`. The register value represents the number of clock (`DT_clk`) periods by which a signal edge is delayed. `DT_CLK` can be selected from `PWM_clk` or `PT_clk` through register `PWM_DT $\times$ _CLK_SEL`.

To calculate the delay on falling edge (FED) and rising edge (RED), use the following formulas:

$$FED = PWM\_DT\_{\times\_FED} \times T_{DT\_clk}$$

$$RED = PWM\_DT\_{\times\_RED} \times T_{DT\_clk}$$

### 16.3.3.3 PWM Carrier Submodule

The coupling of PWM output to a motor driver may need isolation with a transformer. Transformers deliver only AC signals, while the duty cycle of a PWM signal may range anywhere from 0% to 100%. The PWM carrier submodule passes such a PWM signal through a transformer by using a high frequency carrier to modulate the signal.

#### Function Overview

The following key characteristics of this submodule are configurable:

- Carrier frequency
- Pulse width of the first pulse
- Duty cycle of the second and the subsequent pulses
- Enabling/disabling the carrier function

#### Operational Highlights

The PWM carrier clock (PC\_clk) is derived from PWM\_clk. The frequency and duty cycle are configured by the PWM\_CARRIER<sub>x</sub>\_PRESCALE and PWM\_CARRIER<sub>x</sub>\_DUTY bits in the PWM\_CARRIER<sub>x</sub>\_CFG\_REG register. The purpose of one-shot pulses is to provide high-energy impulse to reliably turn on the power switch. Subsequent pulses sustain the power-on status. The width of a one-shot pulse is configurable with the PWM\_CARRIER<sub>x</sub>\_OSHTWTH bits. Enabling/disabling of the carrier submodule is done with the PWM\_CARRIER<sub>x</sub>\_EN bit.

#### Waveform Examples

Figure 16-27 shows an example of waveforms, where a carrier is superimposed on original PWM pulses. This figure do not show the first one-shot pulse and the duty-cycle control. Related details are covered in the following two sections.

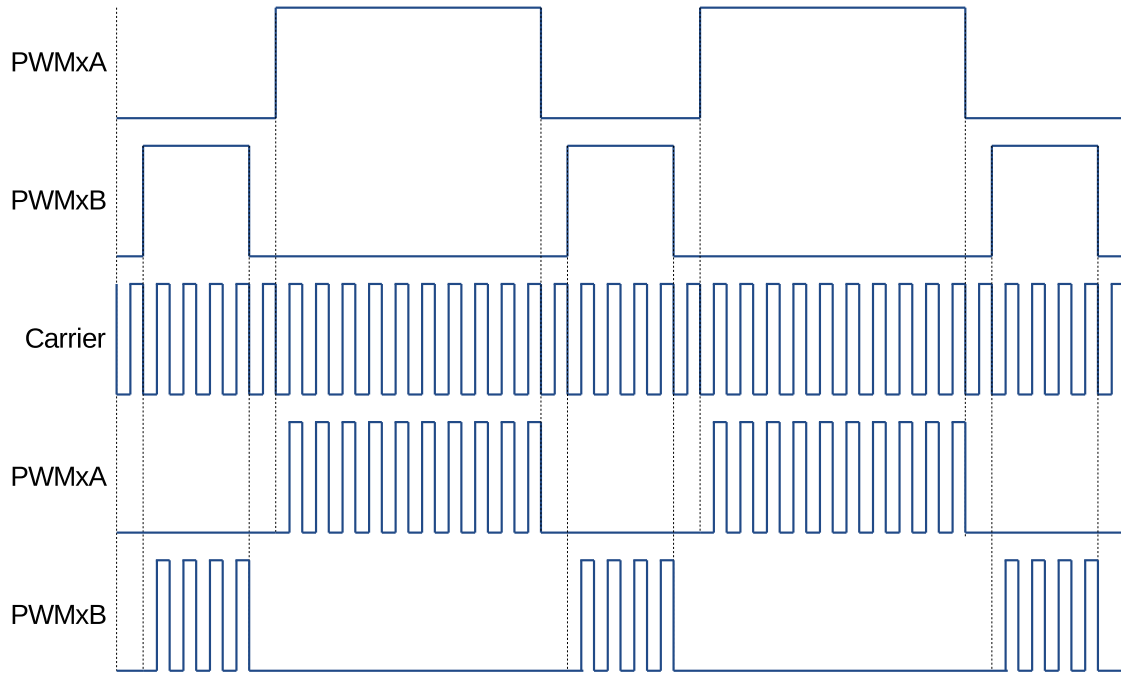


Figure 16-27. Example of Waveforms Showing PWM Carrier Action

### One-Shot Pulse

The width of the first pulse is configurable. It may assume one of 16 possible values and is described by the formula below:

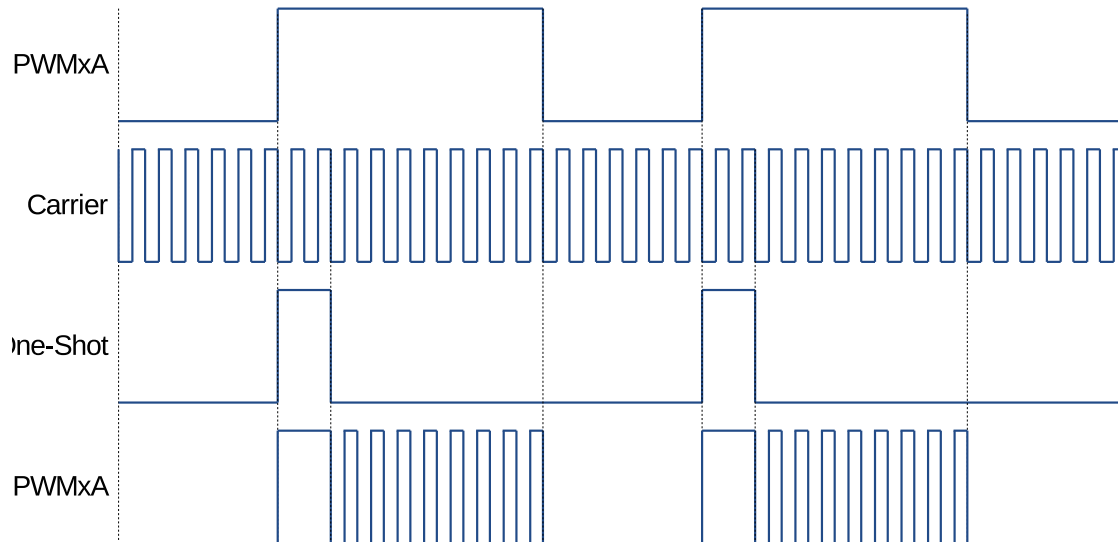
$$T_{1stpulse} = T_{PWM\_clk} \times 8 \times (PWM\_CARRIER\_PRESCALE + 1) \times (PWM\_CARRIER\_OSHTWTH + 1)$$

Where:

- $T_{PWM\_clk}$  is the period of the PWM clock (PWM\_clk).
- $(PWM\_CARRIER\_OSHTWTH + 1)$  is the width of the first pulse (whose value ranges from 1 to 16).
- $(PWM\_CARRIER\_PRESCALE + 1)$  is the PWM carrier clock's (PC\_clk) prescaler value.

The first one-shot pulse and subsequent sustaining pulses are shown in Figure 16-28.





**Figure 16-28. Example of the First Pulse and the Subsequent Sustaining Pulses of the PWM Carrier Submodule**

### Duty Cycle Control

After issuing the first one-shot pulse, the remaining PWM signal is modulated according to the carrier frequency. Users can configure the duty cycle of this signal. Tuning of duty may be required, so that the signal passes through the isolating transformer and can still operate (turn on/off) the motor drive, changing rotation speed and direction.

The duty cycle may be set to one of seven values, using `PWM_CARRIERx_DUTY`, or bits [7:5] of register `PWM_CARRIERx_CFG_REG`.

Below is the formula for calculating the duty cycle:

$$Duty = PWM\_CARRIERx\_DUTY \div 8$$

All seven settings of the duty cycle are shown in Figure 16-29.

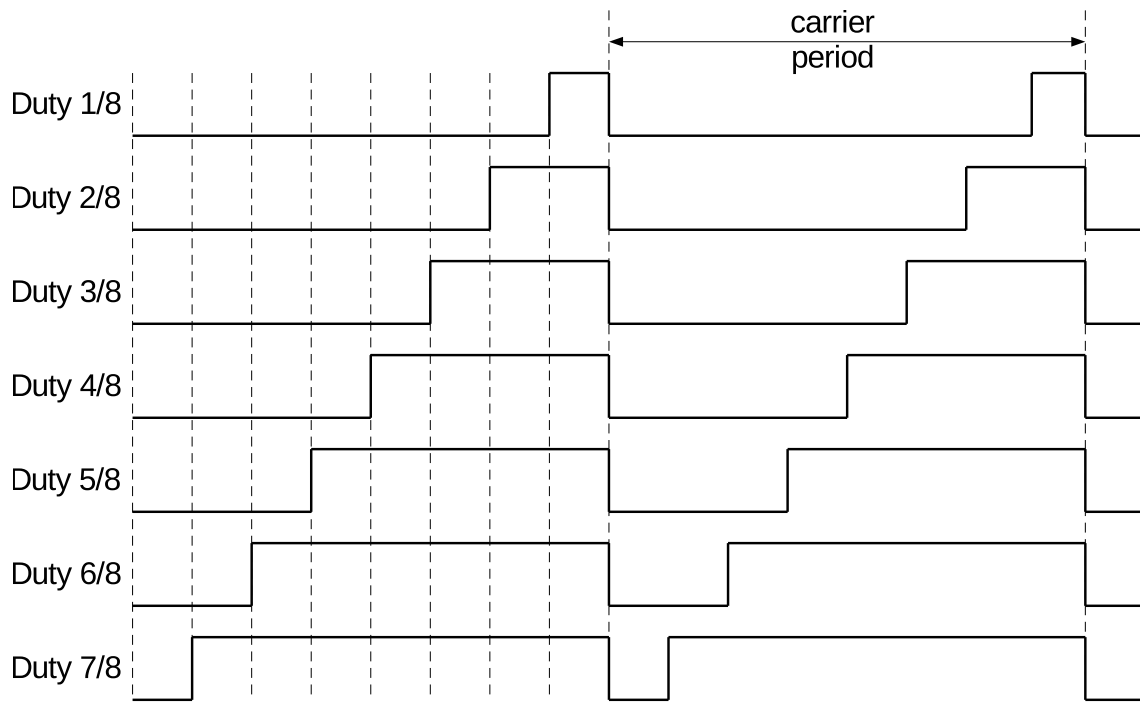


Figure 16-29. Possible Duty Cycle Settings for Sustaining Pulses in the PWM Carrier Submodule

#### 16.3.3.4 Fault Handler Submodule

Each MCPWM peripheral is connected to three fault signals (FAULT0, FAULT1 and FAULT2) which are sourced from the GPIO matrix. These signals are intended to indicate external fault conditions, and may be preprocessed by the fault detection submodule to generate fault events. Fault events can then execute the user code to control MCPWM outputs in response to specific faults.

##### Function of Fault Handler Submodule

The key actions performed by the fault handler submodule are:

- Forcing outputs PWMxA and PWMxB, upon detected fault, to one of the following states:
  - High
  - Low
  - Toggle
  - No action taken
- Execution of one-shot trip (OST) upon detection of over-current conditions/short circuits.
- Cycle-by-cycle tripping (CBC) to provide current-limiting operation.
- Allocation of either one-shot or cycle-by-cycle operation for each fault signal.
- Generation of interrupts for each fault input.
- Support for software-force tripping.
- Enabling or disabling of submodule function as required.

## Operation and Configuration Tips

This section provides the operational tips and set-up options for the fault handler submodule.

Fault signals coming from pads are sampled and synced in the GPIO matrix. In order to guarantee the successful sampling of fault pulses, each pulse duration must be at least two APB clock cycles. The fault detection submodule will then sample fault signals by using PWM\_clk. So, the duration of fault pulses coming from GPIO matrix must be at least one PWM\_clk cycle. Differently put, regardless of the period relation between APB clock and PWM\_clk, the width of fault signal pulses on pads must be at least equal to the sum of two APB clock cycles and one PWM\_clk cycle.

Each level of fault signals, FAULT0 to FAULT2, can be used by the fault handler submodule to generate fault events (fault\_event0 to fault\_event2). Every fault event can be configured individually to provide CBC action, OST action, or none.

- **Cycle-by-Cycle (CBC) action:**

When CBC action is triggered, the state of PWMxA and PWMxB will be changed immediately according to the configuration of registers [PWM\\_FHx\\_A\\_CBC\\_U/D](#) and [PWM\\_FHx\\_B\\_CBC\\_U/D](#). Different actions can be indicted when the PWM timer is incrementing or decrementing. Different CBC action interrupts can be triggered for different fault events. Status register [PWM\\_FHx\\_CBC\\_ON](#) indicates whether a CBC action is on or off. When the fault event is no longer present, CBC actions on PWMxA/B will be cleared at a specified point, which is either a D/UTEP or D/UTEZ event. Register [PWM\\_FHx\\_CBCPULSE](#) determines at which event PWMxA and PWMxB will be able to resume normal actions. Therefore, in this mode, the CBC action is cleared or refreshed upon every PWM cycle.

- **One-Shot (OST) action:**

When OST action is triggered, the state of PWMxA and PWMxB will be changed immediately, depending on the setting of registers [PWM\\_FHx\\_A\\_OST\\_U/D](#) and [PWM\\_FHx\\_B\\_OST\\_U/D](#). Different actions can be configured when PWM timer is incrementing or decrementing. Different OST action interrupts can be triggered from different fault events. Status register [PWM\\_FHx\\_OST\\_ON](#) indicates whether an OST action is on or off. The OST actions on PWMxA/B are not automatically cleared when the fault event is no longer present. One-shot actions must be cleared manually by negating the value stored in register [PWM\\_FHx\\_CLR\\_OST](#).

## 16.3.4 Capture Submodule

### 16.3.4.1 Introduction

The capture submodule contains three complete capture channels. Channel inputs CAP0, CAP1 and CAP2 are sourced from the GPIO matrix. Thanks to the flexibility of the GPIO matrix, CAP0, CAP1 and CAP2 can be configured from any PAD input. Multiple capture channels can be sourced from the same PAD input, while prescaling for each channel can be set differently. Also, capture channels are sourced from different PADS. This provides several options for handling capture signals by hardware in the background, instead of having them processed directly by the CPU. A capture submodule has the following independent key resources:

- One 32-bit timer (counter) which can be synchronized with the PWM timer, another submodule or software.
- Three capture channels, each equipped with a 32-bit time-stamp and a capture prescaler.
- Independent edge polarity (rising/falling edge) selection for any capture channel.
- Input capture signal prescaling (from 1 to 256).
- Interrupt capabilities on any of the three capture events.

### 16.3.4.2 Capture Timer

The capture timer is a 32-bit counter incrementing continuously, once enabled. On the input it has an APB clock running typically at 80 MHz. At a sync event the counter is loaded with phase stored in register [PWM\\_CAP\\_TIMER\\_PHASE\\_REG](#). Sync events can come from PWM timers sync-out, PWM module sync-in or software. The capture timer provides timing references for all three capture channels.

### 16.3.4.3 Capture Channel

The capture signal coming to a capture channel will be inverted first, if needed, and then prescaled. Finally, specified edges of preprocessed capture signal will trigger capture events. When a capture event occurs, the capture timer's value is stored in time-stamp register [PWM\\_CAP\\_CHx\\_REG](#). Different interrupts can be generated for different capture channels at capture events. The edge that triggers a capture event is recorded in register [PWM\\_CAPx\\_EDGE](#). The capture event can be also forced by software.

## 16.4 Register Summary

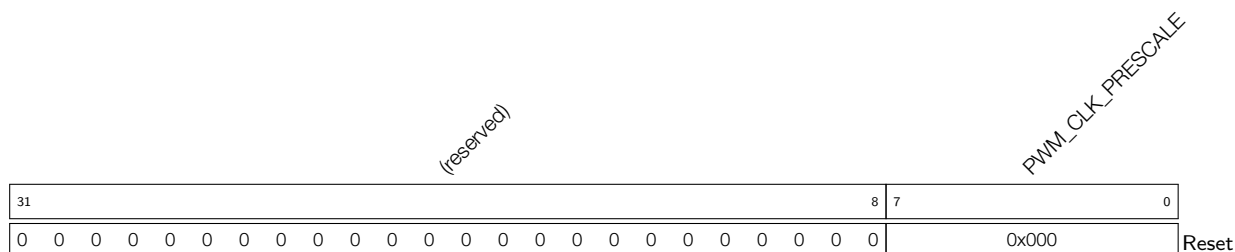
Name	Description	PWM0	PWM1	Acc
<b>Prescaler configuration</b>				
PWM_CLK_CFG_REG	Configuration of the prescaler	0x3FF5E000	0x3FF6C000	R/W
<b>PWM Timer 0 Configuration and status</b>				
PWM_TIMER0_CFG0_REG	Timer period and update method	0x3FF5E004	0x3FF6C004	R/W
PWM_TIMER0_CFG1_REG	Working mode and start/stop control	0x3FF5E008	0x3FF6C008	R/W
PWM_TIMER0_SYNC_REG	Synchronization settings	0x3FF5E00C	0x3FF6C00C	R/W
PWM_TIMER0_STATUS_REG	Timer status	0x3FF5E010	0x3FF6C010	RO
<b>PWM Timer 1 Configuration and Status</b>				
PWM_TIMER1_CFG0_REG	Timer update method and period	0x3FF5E014	0x3FF6C014	R/W
PWM_TIMER1_CFG1_REG	Working mode and start/stop control	0x3FF5E018	0x3FF6C018	R/W
PWM_TIMER1_SYNC_REG	Synchronization settings	0x3FF5E01C	0x3FF6C01C	R/W
PWM_TIMER1_STATUS_REG	Timer status	0x3FF5E020	0x3FF6C020	RO
<b>PWM Timer 2 Configuration and status</b>				
PWM_TIMER2_CFG0_REG	Timer update method and period	0x3FF5E024	0x3FF6C024	R/W
PWM_TIMER2_CFG1_REG	Working mode and start/stop control	0x3FF5E028	0x3FF6C028	R/W
PWM_TIMER2_SYNC_REG	Synchronization settings	0x3FF5E02C	0x3FF6C02C	R/W
PWM_TIMER2_STATUS_REG	Timer status	0x3FF5E030	0x3FF6C030	RO
<b>Common configuration for PWM timers</b>				
PWM_TIMER_SYNCI_CFG_REG	Synchronization input selection for timers	0x3FF5E034	0x3FF6C034	R/W
PWM_OPERATOR_TIMERSEL_REG	Select specific timer for PWM operators	0x3FF5E038	0x3FF6C038	R/W
<b>PWM Operator 0 Configuration and Status</b>				
PWM_GEN0_STMP_CFG_REG	Transfer status and update method for time stamp registers A and B	0x3FF5E03C	0x3FF6C03C	R/W
PWM_GEN0_TSTMP_A_REG	Shadow register for register A	0x3FF5E040	0x3FF6C040	R/W
PWM_GEN0_TSTMP_B_REG	Shadow register for register B	0x3FF5E044	0x3FF6C044	R/W
PWM_GEN0_CFG0_REG	Fault event T0 and T1 handling	0x3FF5E048	0x3FF6C048	R/W
PWM_GEN0_FORCE_REG	Permissives to force PWM0A and PWM0B outputs by software	0x3FF5E04C	0x3FF6C04C	R/W
PWM_GEN0_A_REG	Actions triggered by events on PWM0A	0x3FF5E050	0x3FF6C050	R/W
PWM_GEN0_B_REG	Actions triggered by events on PWM0B	0x3FF5E054	0x3FF6C054	R/W
PWM_DT0_CFG_REG	Dead time type selection and configuration	0x3FF5E058	0x3FF6C058	R/W
PWM_DT0_FED_CFG_REG	Shadow register for falling edge delay (FED)	0x3FF5E05C	0x3FF6C05C	R/W
PWM_DT0_RED_CFG_REG	Shadow register for rising edge delay (RED)	0x3FF5E060	0x3FF6C060	R/W
PWM_CARRIER0_CFG_REG	Carrier enable and configuration	0x3FF5E064	0x3FF6C064	R/W

Name	Description	PWM0	PWM1	Acc
PWM_FH0_CFG0_REG	Actions on PWM0A and PWM0B on trip events	0x3FF5E068	0x3FF6C068	R/W
PWM_FH0_CFG1_REG	Software triggers for fault handler actions	0x3FF5E06C	0x3FF6C06C	R/W
PWM_FH0_STATUS_REG	Status of fault events	0x3FF5E070	0x3FF6C070	RO
<b>PWM Operator 1 Configuration and Status</b>				
PWM_GEN1_STMP_CFG_REG	Transfer status and update method for time stamp registers A and B	0x3FF5E074	0x3FF6C074	R/W
PWM_GEN1_TSTMP_A_REG	Shadow register for register A	0x3FF5E078	0x3FF6C078	R/W
PWM_GEN1_TSTMP_B_REG	Shadow register for register B	0x3FF5E07C	0x3FF6C07C	R/W
PWM_GEN1_CFG0_REG	Fault event T0 and T1 handling	0x3FF5E080	0x3FF6C080	R/W
PWM_GEN1_FORCE_REG	Permissives to force PWM1A and PWM1B outputs by software	0x3FF5E084	0x3FF6C084	R/W
PWM_GEN1_A_REG	Actions triggered by events on PWM1A	0x3FF5E088	0x3FF6C088	R/W
PWM_GEN1_B_REG	Actions triggered by events on PWM1B	0x3FF5E08C	0x3FF6C08C	R/W
PWM_DT1_CFG_REG	Dead time type selection and configuration	0x3FF5E090	0x3FF6C090	R/W
PWM_DT1_FED_CFG_REG	Shadow register for FED	0x3FF5E094	0x3FF6C094	R/W
PWM_DT1_RED_CFG_REG	Shadow register for RED	0x3FF5E098	0x3FF6C098	R/W
PWM_CARRIER1_CFG_REG	Carrier enable and configuration	0x3FF5E09C	0x3FF6C09C	R/W
PWM_FH1_CFG0_REG	Actions on PWM1A and PWM1B on fault events	0x3FF5E0A0	0x3FF6C0A0	R/W
PWM_FH1_CFG1_REG	Software triggers for fault handler actions	0x3FF5E0A4	0x3FF6C0A4	R/W
PWM_FH1_STATUS_REG	Status of fault events	0x3FF5E0A8	0x3FF6C0A8	RO
<b>PWM Operator 2 Configuration and Status</b>				
PWM_GEN2_STMP_CFG_REG	Transfer status and updating method for time stamp registers A and B	0x3FF5E0AC	0x3FF6C0AC	R/W
PWM_GEN2_TSTMP_A_REG	Shadow register for register A	0x3FF5E0B0	0x3FF6C0B0	R/W
PWM_GEN2_TSTMP_B_REG	Shadow register for register B	0x3FF5E0B4	0x3FF6C0B4	R/W
PWM_GEN2_CFG0_REG	Fault event T0 and T1 handling	0x3FF5E080	0x3FF6C080	R/W
PWM_GEN2_FORCE_REG	Permissives to force PWM2A and PWM2B outputs by software	0x3FF5E0BC	0x3FF6C0BC	R/W
PWM_GEN2_A_REG	Actions triggered by events on PWM2A	0x3FF5E0C0	0x3FF6C0C0	R/W
PWM_GEN2_B_REG	Actions triggered by events on PWM2B	0x3FF5E0C4	0x3FF6C0C4	R/W
PWM_DT2_CFG_REG	Dead time type selection and configuration	0x3FF5E0C8	0x3FF6C0C8	R/W
PWM_DT2_FED_CFG_REG	Shadow register for FED	0x3FF5E0CC	0x3FF6C0CC	R/W
PWM_DT2_RED_CFG_REG	Shadow register for RED	0x3FF5E0D0	0x3FF6C0D0	R/W
PWM_CARRIER2_CFG_REG	Carrier enable and configuration	0x3FF5E0D4	0x3FF6C0D4	R/W

Name	Description	PWM0	PWM1	Acc
PWM_FH2_CFG0_REG	Actions at PWM2A and PWM2B on trip events	0x3FF5E0D8	0x3FF6C0D8	R/W
PWM_FH2_CFG1_REG	Software triggers for fault handler actions	0x3FF5E0DC	0x3FF6C0DC	R/W
PWM_FH2_STATUS_REG	Status of fault events	0x3FF5E0E0	0x3FF6C0E0	RO
<b>Fault Detection Configuration and Status</b>				
PWM_FAULT_DETECT_REG	Fault detection configuration and status	0x3FF5E0E4	0x3FF6C0E4	R/W
<b>Capture Configuration and Status</b>				
PWM_CAP_TIMER_CFG_REG	Configure capture timer	0x3FF5E0E8	0x3FF6C0E8	R/W
PWM_CAP_TIMER_PHASE_REG	Phase for capture timer sync	0x3FF5E0EC	0x3FF6C0EC	R/W
PWM_CAP_CH0_CFG_REG	Capture channel 0 configuration and enable	0x3FF5E0F0	0x3FF6C0F0	R/W
PWM_CAP_CH1_CFG_REG	Capture channel 1 configuration and enable	0x3FF5E0F4	0x3FF6C0F4	R/W
PWM_CAP_CH2_CFG_REG	Capture channel 2 configuration and enable	0x3FF5E0F8	0x3FF6C0F8	R/W
PWM_CAP_CH0_REG	Value of last capture on channel 0	0x3FF5E0FC	0x3FF6C0FC	RO
PWM_CAP_CH1_REG	Value of last capture on channel 1	0x3FF5E100	0x3FF6C100	RO
PWM_CAP_CH2_REG	Value of last capture on channel 2	0x3FF5E104	0x3FF6C104	RO
PWM_CAP_STATUS_REG	Edge of last capture trigger	0x3FF5E108	0x3FF6C108	RO
<b>Enable update of active registers</b>				
PWM_UPDATE_CFG_REG	Enable update	0x3FF5E10C	0x3FF6C10C	R/W
<b>Manage Interrupts</b>				
INT_ENA_PWM_REG	Interrupt enable bits	0x3FF5E110	0x3FF6C110	R/W
INT_RAW_PWM_REG	Raw interrupt status	0x3FF5E114	0x3FF6C114	RO
INT_ST_PWM_REG	Masked interrupt status	0x3FF5E118	0x3FF6C118	RO
INT_CLR_PWM_REG	Interrupt clear bits	0x3FF5E11C	0x3FF6C11C	WO

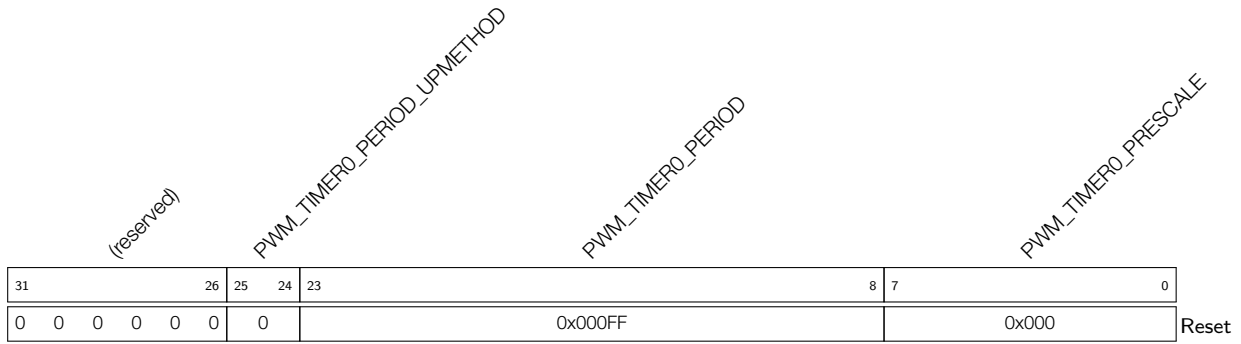
## 16.5 Registers

Register 16.1. PWM\_CLK\_CFG\_REG (0x0000)



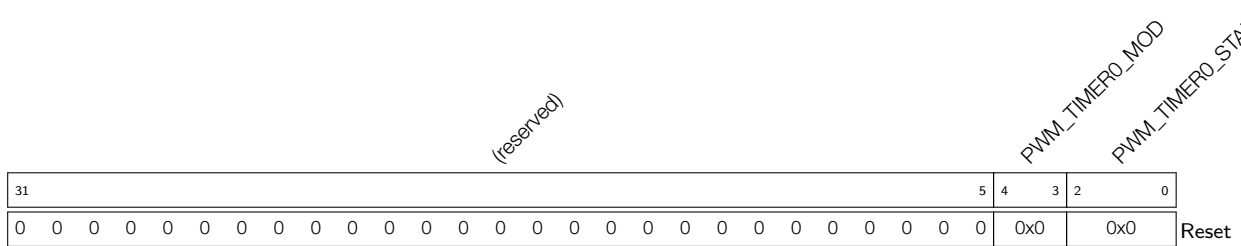
**PWM\_CLK\_PRESCALE** Period of PWM\_clk = 6.25ns \* (PWM\_CLK\_PRESCALE + 1). (R/W)

**Register 16.2. PWM\_TIMER0\_CFG0\_REG (0x0004)**



- PWM\_TIMER0\_PERIOD\_UPMETHOD** Updating method for active register of PWM timer0 period.  
0: immediately, 1: update at TEZ, 2: update at sync, 3: update at TEZ or sync. TEZ here and below means that the event that happens when the timer equals to zero. (R/W)
- PWM\_TIMER0\_PERIOD** Period shadow register of PWM timer0. (R/W)
- PWM\_TIMER0\_PRESCALE** Period of PT0\_clk = Period of PWM\_clk \* (PWM\_TIMER0\_PRESCALE + 1). (R/W)

**Register 16.3. PWM\_TIMER0\_CFG1\_REG (0x0008)**



- PWM\_TIMER0\_MOD** PWM timer0 working mode. 0: freeze, 1: increase mode, 2: decrease mode, 3: up-down mode. (R/W)
- PWM\_TIMER0\_START** PWM timer0 start and stop control. 0: if PWM timer0 starts, then stops at TEZ; 1: if timer0 starts, then stops at TEP; 2: PWM timer0 starts and runs on; 3: timer0 starts and stops at the next TEZ; 4: timer0 starts and stops at the next TEP. TEP here and below means the event that happens when the timer equals to period. (R/W)



Register 16.4. PWM\_TIMER0\_SYNC\_REG (0x000c)

(reserved)										PWM_TIMER0_PHASE_DIRECTION										PWM_TIMER0_PHASE										PWM_TIMER0_SYNC_SEL					PWM_TIMER0_SYNC_SW					PWM_TIMER0_SYNCLEN				
31											21	20	19											4	3	2	1	0																
0 0 0 0 0 0 0 0 0 0										0										0					0					Reset														

**PWM\_TIMER0\_PHASE\_DIRECTION** 0: increase; 1: decrease. (R/W)

**PWM\_TIMER0\_PHASE** Phase for timer reload at sync event. (R/W)

**PWM\_TIMER1\_SYNC\_SEL** PWM timer0 sync\_out selection. 0: sync\_in; 1: TEZ; 2: TEP; otherwise: sync\_out is always 0. (R/W)

**PWM\_TIMER1\_SYNC\_SW** Toggling this bit will trigger a software sync. (R/W)

**PWM\_TIMER1\_SYNCI\_EN** When set, timer reloading with phase on sync input event is enabled. (R/W)

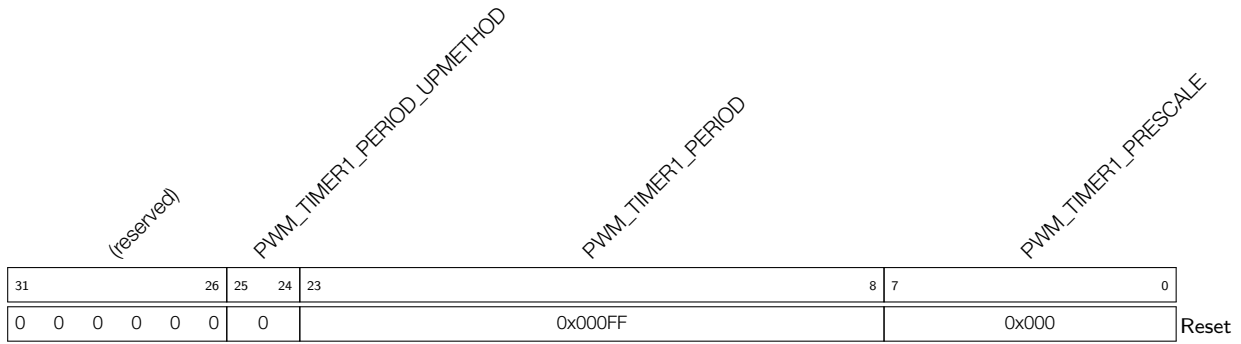
Register 16.5. PWM\_TIMER0\_STATUS\_REG (0x0010)

(reserved)										PWM_TIMER0_DIRECTION										PWM_TIMER0_VALUE										
31											17	16	15											0						
0 0 0 0 0 0 0 0 0 0										0										0										Reset

**PWM\_TIMER0\_DIRECTION** Current direction of the PWM timer0 counter. 0: increment, 1: decrement. (RO)

**PWM\_TIMER0\_VALUE** Current value of the PWM timer0 counter. (RO)

**Register 16.6. PWM\_TIMER1\_CFG0\_REG (0x0014)**

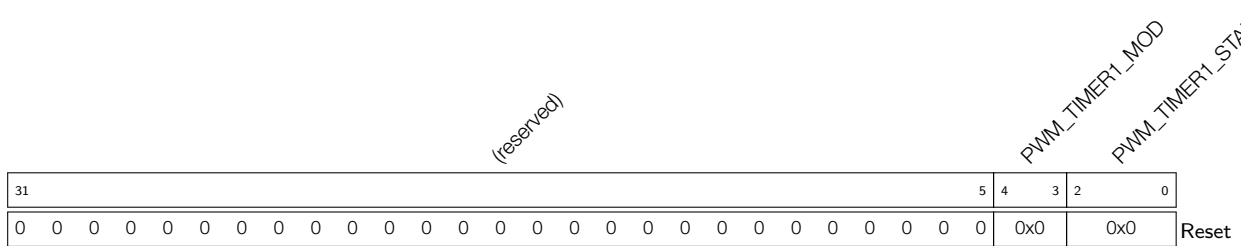


**PWM\_TIMER1\_PERIOD\_UPMETHOD** Updating method for the active register of PWM timer1 period. 0: immediately, 1: update at TEZ, 2: update at sync, 3: update at TEZ or sync. (R/W)

**PWM\_TIMER1\_PERIOD** Period shadow register of the PWM timer1. (R/W)

**PWM\_TIMER1\_PRESCALE** Period of PT1\_clk = Period of PWM\_clk \* (PWM\_TIMER1\_PRESCALE + 1) (R/W)

**Register 16.7. PWM\_TIMER1\_CFG1\_REG (0x0018)**



**PWM\_TIMER1\_MOD** PWM timer1 working mode. 0: freeze, 1: increase mode, 2: decrease mode, 3: up-down mode. (R/W)

**PWM\_TIMER1\_START** PWM timer1 start and stop control. 0: if PWM timer1 starts, then stops at TEZ; 1: if PWM timer1 starts, then stops at TEP; 2: PWM timer1 starts and runs on; 3: PWM timer1 starts and stops at the next TEZ; 4: PWM timer1 starts and stops at the next TEP. (R/W)

Register 16.8. PWM\_TIMER1\_SYNC\_REG (0x001c)

(reserved)										PWM_TIMER1_PHASE_DIRECTION										PWM_TIMER1_PHASE										PWM_TIMER1_SYNC_SEL					PWM_TIMER1_SYNC_SW					PWM_TIMER1_SYNCLEN				
31											21	20	19											4	3	2	1	0																
0 0 0 0 0 0 0 0 0 0										0										0					0					Reset														

**PWM\_TIMER1\_PHASE\_DIRECTION** 0: increase; 1: decrease. (R/W)

**PWM\_TIMER1\_PHASE** Phase for timer reload at sync event. (R/W)

**PWM\_TIMER1\_SYNC\_SEL** PWM timer1 sync\_out selection. 0: sync\_in; 1: TEZ; 2: TEP; otherwise: sync\_out is always 0. (R/W)

**PWM\_TIMER1\_SYNC\_SW** Toggling this bit will trigger a software sync. (R/W)

**PWM\_TIMER1\_SYNCI\_EN** When set, timer reloading with phase at a sync input event is enabled. (R/W)

Register 16.9. PWM\_TIMER1\_STATUS\_REG (0x0020)

(reserved)										PWM_TIMER1_DIRECTION										PWM_TIMER1_VALUE										
31											17	16	15											0						
0 0 0 0 0 0 0 0 0 0										0										0										Reset

**PWM\_TIMER1\_DIRECTION** Current direction of the PWM timer1 counter. 0: increment 1: decrement. (RO)

**PWM\_TIMER1\_VALUE** Current value of the PWM timer1 counter. (RO)

**Register 16.10. PWM\_TIMER2\_CFG0\_REG (0x0024)**

(reserved)						PWM_TIMER2_PERIOD_UPMETHOD						PWM_TIMER2_PERIOD								PWM_TIMER2_PRESCALE				
31						26	25	24	23							8	7				0			
0 0 0 0 0 0						0						0x00FF								0x000				Reset

**PWM\_TIMER2\_PERIOD\_UPMETHOD** Updating method for active register of PWM timer2 period.

0: immediately, 1: update at TEZ, 2: update at sync, 3: update at TEZ or sync. (R/W)

**PWM\_TIMER2\_PERIOD** Period shadow register of PWM timer2. (R/W)

**PWM\_TIMER2\_PRESCALE** Period of PT2\_clk = Period of PWM\_clk \* (PWM\_TIMER2\_PRESCALE + 1). (R/W)

**Register 16.11. PWM\_TIMER2\_CFG1\_REG (0x0028)**

(reserved)																PWM_TIMER2_MOD				PWM_TIMER2_START				
31																5	4	3	2				0	
0 0 0 0 0 0 0 0 0 0 0 0 0 0 0 0																0x0				0x0				Reset

**PWM\_TIMER2\_MOD** PWM timer2 working mode. 0: freeze, 1: increase mode, 2: decrease mode, 3: up-down mode. (R/W)

**PWM\_TIMER2\_START** PWM timer2 start and stop control. 0: if PWM timer2 starts, then stops at TEZ; 1: if PWM timer2 starts, then stops at TEP; 2: PWM timer2 starts and runs on; 3: PWM timer2 starts and stops at the next TEZ; 4: PWM timer2 starts and stops at the next TEP. (R/W)

Register 16.12. PWM\_TIMER2\_SYNC\_REG (0x002c)

(reserved)										PWM_TIMER2_PHASE_DIRECTION										PWM_TIMER2_PHASE										PWM_TIMER2_SYNC_SEL					PWM_TIMER2_SYNC_SW					PWM_TIMER2_SYNC_EN				
31											21	20	19											4	3	2	1	0																
0 0 0 0 0 0 0 0 0 0										0										0					0					Reset														

**PWM\_TIMER2\_PHASE\_DIRECTION** 0: increase; 1: decrease. (R/W)

**PWM\_TIMER2\_PHASE** Phase for timer reload at sync event. (R/W)

**PWM\_TIMER2\_SYNC\_SEL** PWM timer2 sync\_out selection. 0: sync\_in; 1: TEZ; 2: TEP; otherwise: sync\_out is always 0. (R/W)

**PWM\_TIMER2\_SYNC\_SW** Toggling this bit will trigger a software sync. (R/W)

**PWM\_TIMER2\_SYNCI\_EN** When set, timer reloading with phase on sync input event is enabled. (R/W)

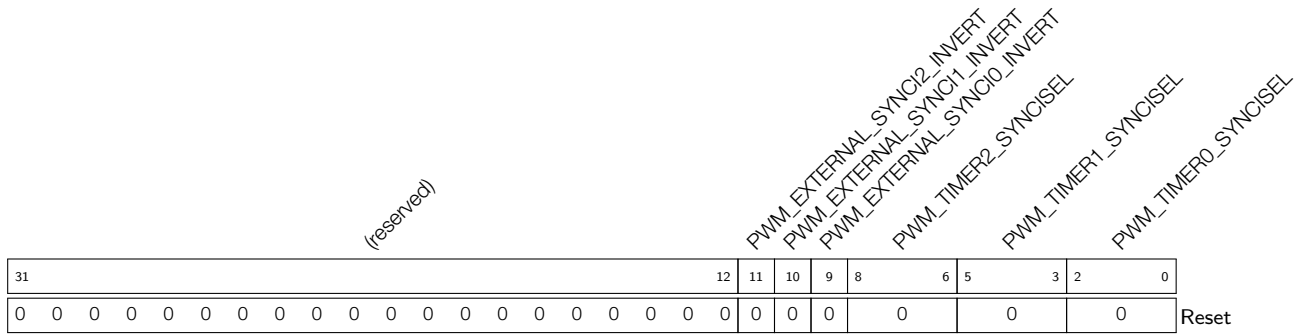
Register 16.13. PWM\_TIMER2\_STATUS\_REG (0x0030)

(reserved)										PWM_TIMER2_DIRECTION										PWM_TIMER2_VALUE										
31											17	16	15											0						
0 0 0 0 0 0 0 0 0 0										0										0										Reset

**PWM\_TIMER2\_DIRECTION** Current direction of the PWM timer2 counter. 0: increment, 1: decrement. (RO)

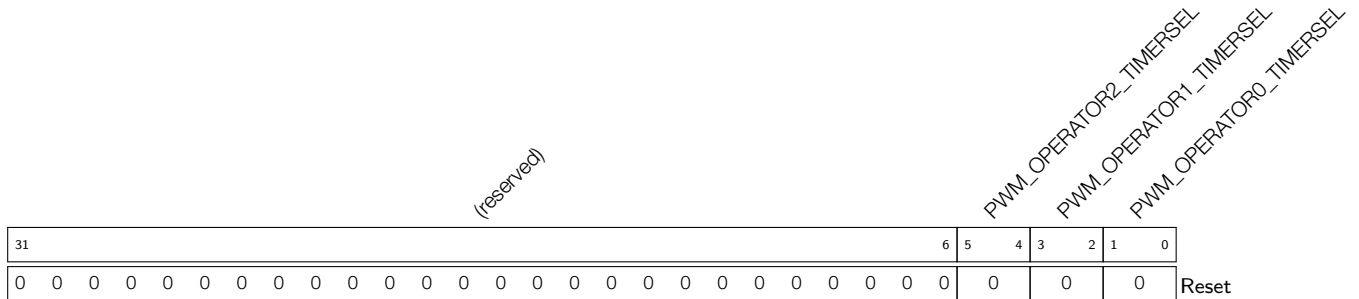
**PWM\_TIMER2\_VALUE** Current value of the PWM timer2 counter. (RO)

Register 16.14. PWM\_TIMER\_SYNCI\_CFG\_REG (0x0034)



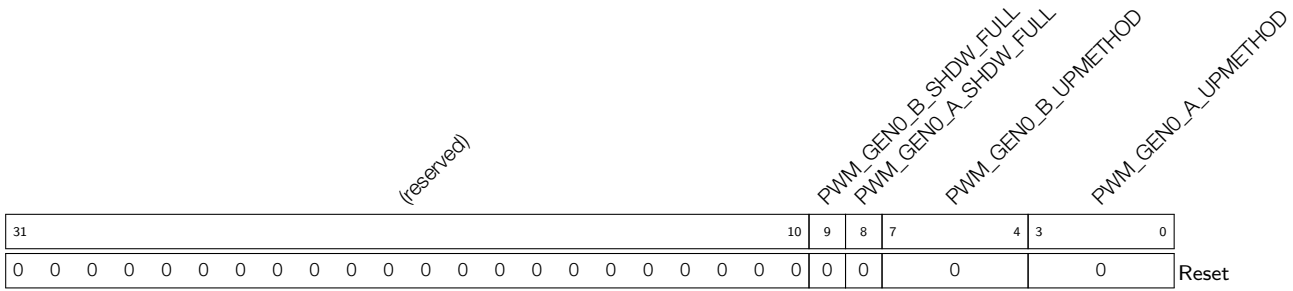
- PWM\_EXTERNAL\_SYNCI2\_INVERT** Invert SYNC2 from GPIO matrix. (R/W)
- PWM\_EXTERNAL\_SYNCI1\_INVERT** Invert SYNC1 from GPIO matrix. (R/W)
- PWM\_EXTERNAL\_SYNCI0\_INVERT** Invert SYNC0 from GPIO matrix. (R/W)
- PWM\_TIMER2\_SYNCISEL** Select sync input for PWM timer2. 1: PWM timer0 sync\_out, 2: PWM timer1 sync\_out, 3: PWM timer2 sync\_out, 4: SYNC0 from GPIO matrix, 5: SYNC1 from GPIO matrix, 6: SYNC2 from GPIO matrix, other values: no sync input selected. (R/W)
- PWM\_TIMER1\_SYNCISEL** Select sync input for PWM timer1. 1: PWM timer0 sync\_out, 2: PWM timer1 sync\_out, 3: PWM timer2 sync\_out, 4: SYNC0 from GPIO matrix, 5: SYNC1 from GPIO matrix, 6: SYNC2 from GPIO matrix, other values: no sync input selected. (R/W)
- PWM\_TIMER0\_SYNCISEL** Select sync input for PWM timer0. 1: PWM timer0 sync\_out, 2: PWM timer1 sync\_out, 3: PWM timer2 sync\_out, 4: SYNC0 from GPIO matrix, 5: SYNC1 from GPIO matrix, 6: SYNC2 from GPIO matrix, other values: no sync input selected. (R/W)

Register 16.15. PWM\_OPERATOR\_TIMERSEL\_REG (0x0038)



- PWM\_OPERATOR2\_TIMERSEL** Select the PWM timer for PWM operator2's timing reference. 0: timer0, 1: timer1, 2: timer2. (R/W)
- PWM\_OPERATOR1\_TIMERSEL** Select the PWM timer for PWM operator1's timing reference. 0: timer0, 1: timer1, 2: timer2. (R/W)
- PWM\_OPERATOR0\_TIMERSEL** Select the PWM timer for PWM operator0's timing reference. 0: timer0, 1: timer1, 2: timer2. (R/W)

**Register 16.16. PWM\_GEN0\_STMP\_CFG\_REG (0x003c)**



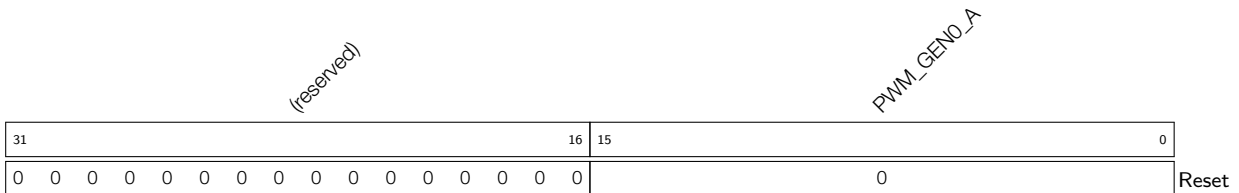
**PWM\_GEN0\_B\_SHDW\_FULL** Set and reset by hardware. If set, PWM generator 0 time stamp B’s shadow register.ister is filled and to be transferred to time stamp B’s active register. If cleared, time stamp B’s active register has been updated with Shadow register latest value. (RO)

**PWM\_GEN0\_A\_SHDW\_FULL** Set and reset by hardware. If set, PWM generator 0 time stamp A’s shadow register.ister is filled and to be transferred to time stamp A’s active register. If cleared, time stamp A’s active register has been updated with Shadow register latest value. (RO)

**PWM\_GEN0\_B\_UPMETHOD** Updating method for PWM generator 0 time stamp B’s active register. When all bits are set to 0: immediately; when bit0 is set to 1: TEZ; when bit1 is set to 1: TEP; when bit2 is set to 1: sync; when bit3 is set to 1: disable the update. (R/W)

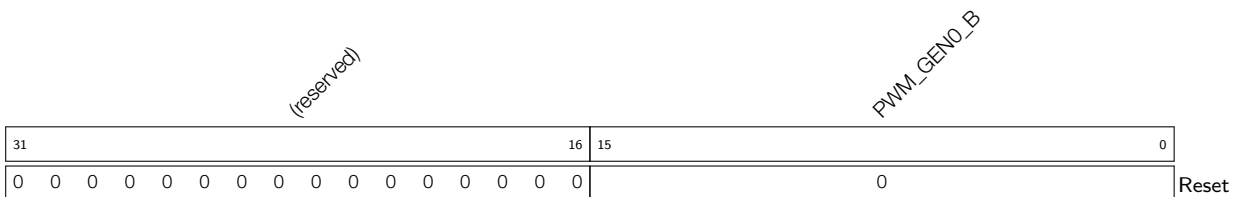
**PWM\_GEN0\_A\_UPMETHOD** Updating method for PWM generator 0 time stamp A’s active register. When all bits are set to 0: immediately; when bit0 is set to 1: TEZ; when bit1 is set to 1: TEP; when bit2 is set to 1: sync; when bit3 is set to 1: disable the update. (R/W)

**Register 16.17. PWM\_GEN0\_TSTMP\_A\_REG (0x0040)**



**PWM\_GEN0\_A** PWM generator 0 time stamp A’s shadow register. (R/W)

**Register 16.18. PWM\_GEN0\_TSTMP\_B\_REG (0x0044)**



**PWM\_GEN0\_B** PWM generator 0 time stamp B’s shadow register. (R/W)

Register 16.19. PWM\_GEN0\_CFG0\_REG (0x0048)

(reserved)										PWM_GEN0_T1_SEL		PWM_GEN0_T0_SEL		PWM_GEN0_CFG_UPMETHOD				
31											10	9	7	6	4	3	0	
0	0	0	0	0	0	0	0	0	0	0	0	0	0	0	0	0	0	Reset

**PWM\_GEN0\_T1\_SEL** Source selection for PWM generator 0 event\_t1, taking effect immediately. 0: fault\_event0, 1: fault\_event1, 2: fault\_event2, 3: sync\_taken, 4: none. (R/W)

**PWM\_GEN0\_T0\_SEL** Source selection for PWM generator 0 event\_t0, taking effect immediately, 0: fault\_event0, 1: fault\_event1, 2: fault\_event2, 3: sync\_taken, 4: none. (R/W)

**PWM\_GEN0\_CFG\_UPMETHOD** Updating method for PWM generator 0's active register of configuration. When all bits are set to 0: immediately; when bit0 is set to 1: TEZ; when bit1 is set to 1: TEP; when bit2 is set to 1: sync; when bit3 is set to 1: disable the update. (R/W)



**Register 16.20. PWM\_GEN0\_FORCE\_REG (0x004c)**

(reserved)																	PWM_GEN0_B_NCIFORCE_MODE	PWM_GEN0_B_NCIFORCE	PWM_GEN0_A_NCIFORCE_MODE	PWM_GEN0_A_NCIFORCE	PWM_GEN0_B_CNTUFORCE_MODE	PWM_GEN0_A_CNTUFORCE_MODE	PWM_GEN0_CNTUFORCE_UPMETHOD								
31	30	29	28	27	26	25	24	23	22	21	20	19	18	17	16	15	14	13	12	11	10	9	8	7	6	5	4	3	2	1	0
0	0	0	0	0	0	0	0	0	0	0	0	0	0	0	0	0	0	0	0	0	0	0	0	0	0	0	0	0	0	0	0
																								0	0	0x20				Reset	

**PWM\_GEN0\_B\_NCIFORCE\_MODE** Non-continuous immediate software-force mode for PWM0B.  
0: disabled, 1: low, 2: high, 3: disabled. (R/W)

**PWM\_GEN0\_B\_NCIFORCE** Trigger of non-continuous immediate software-force event for PWM0B;  
a toggle will trigger a force event. (R/W)

**PWM\_GEN0\_A\_NCIFORCE\_MODE** Non-continuous immediate software-force mode for PWM0A,  
0: disabled, 1: low, 2: high, 3: disabled. (R/W)

**PWM\_GEN0\_A\_NCIFORCE** Trigger of non-continuous immediate software-force event for PWM0A;  
a toggle will trigger a force event. (R/W)

**PWM\_GEN0\_B\_CNTUFORCE\_MODE** Continuous software-force mode for PWM0B. 0: disabled,  
1: low, 2: high, 3: disabled. (R/W)

**PWM\_GEN0\_A\_CNTUFORCE\_MODE** Continuous software-force mode for PWM0A. 0: disabled, 1:  
low, 2: high, 3: disabled. (R/W)

**PWM\_GEN0\_CNTUFORCE\_UPMETHOD** Updating method for continuous software force of PWM  
generator0. When all bits are set to 0: immediately; when bit0 is set to 1: TEZ; when bit1 is set  
to 1: TEP; when bit2 is set to 1: TEA; when bit3 is set to 1: TEB; when bit4 is set to 1: sync;  
when bit5 is set to 1: disable update. (TEA/B here and below means an event generated when  
the timer's value equals to that of register A/B.) (R/W)

**Register 16.21. PWM\_GEN0\_A\_REG (0x0050)**

(reserved)								PWM_GEN0_A_DT1		PWM_GEN0_A_DT0		PWM_GEN0_A_DTEB		PWM_GEN0_A_DTEA		PWM_GEN0_A_DTEP		PWM_GEN0_A_DTEZ		PWM_GEN0_A_UT1		PWM_GEN0_A_UT0		PWM_GEN0_A_UTEB		PWM_GEN0_A_UTEA		PWM_GEN0_A_UTEZ					
31	30	29	28	27	26	25	24	23	22	21	20	19	18	17	16	15	14	13	12	11	10	9	8	7	6	5	4	3	2	1	0		
0	0	0	0	0	0	0	0	0	0	0	0	0	0	0	0	0	0	0	0	0	0	0	0	0	0	0	0	0	0	0	0	0	0

Reset

**PWM\_GEN0\_A\_DT1** Action on PWM0A triggered by event\_t1 when the timer decreases. 0: no change, 1: low, 2: high, 3: toggle. (R/W)

**PWM\_GEN0\_A\_DT0** Action on PWM0A triggered by event\_t0 when the timer decreases. (R/W)

**PWM\_GEN0\_A\_DTEB** Action on PWM0A triggered by event TEB when the timer decreases. (R/W)

**PWM\_GEN0\_A\_DTEA** Action on PWM0A triggered by event TEA when the timer decreases. (R/W)

**PWM\_GEN0\_A\_DTEP** Action on PWM0A triggered by event TEP when the timer decreases. (R/W)

**PWM\_GEN0\_A\_DTEZ** Action on PWM0A triggered by event TEZ when the timer decreases. (R/W)

**PWM\_GEN0\_A\_UT1** Action on PWM0A triggered by event\_t1 when the timer increases. (R/W)

**PWM\_GEN0\_A\_UT0** Action on PWM0A triggered by event\_t0 when the timer increases. (R/W)

**PWM\_GEN0\_A\_UTEB** Action on PWM0A triggered by event TEB when the timer increases. (R/W)

**PWM\_GEN0\_A\_UTEA** Action on PWM0A triggered by event TEA when the timer increases. (R/W)

**PWM\_GEN0\_A\_UTEZ** Action on PWM0A triggered by event TEP when the timer increases. (R/W)

**PWM\_GEN0\_A\_UTEZ** Action on PWM0A triggered by event TEZ when the timer increases. (R/W)

**Register 16.22. PWM\_GEN0\_B\_REG (0x0054)**

(reserved)								PWM_GEN0_B_DT1		PWM_GEN0_B_DT0		PWM_GEN0_B_DTEB		PWM_GEN0_B_DTEA		PWM_GEN0_B_DTEP		PWM_GEN0_B_DTEZ		PWM_GEN0_B_UT1		PWM_GEN0_B_UT0		PWM_GEN0_B_UTEB		PWM_GEN0_B_UTEA		PWM_GEN0_B_UTEZ					
31	30	29	28	27	26	25	24	23	22	21	20	19	18	17	16	15	14	13	12	11	10	9	8	7	6	5	4	3	2	1	0		
0	0	0	0	0	0	0	0	0	0	0	0	0	0	0	0	0	0	0	0	0	0	0	0	0	0	0	0	0	0	0	0	0	0

Reset

**PWM\_GEN0\_B\_DT1** Action on PWM0B triggered by event\_t1 when the timer decreases. 0: no change, 1: low, 2: high, 3: toggle. (R/W)

**PWM\_GEN0\_B\_DT0** Action on PWM0B triggered by event\_t0 when the timer decreases. (R/W)

**PWM\_GEN0\_B\_DTEB** Action on PWM0B triggered by event TEB when the timer decreases. (R/W)

**PWM\_GEN0\_B\_DTEA** Action on PWM0B triggered by event TEA when the timer decreases. (R/W)

**PWM\_GEN0\_B\_DTEP** Action on PWM0B triggered by event TEP when the timer decreases. (R/W)

**PWM\_GEN0\_B\_DTEZ** Action on PWM0B triggered by event TEZ when the timer decreases. (R/W)

**PWM\_GEN0\_B\_UT1** Action on PWM0B triggered by event\_t1 when the timer increases. (R/W)

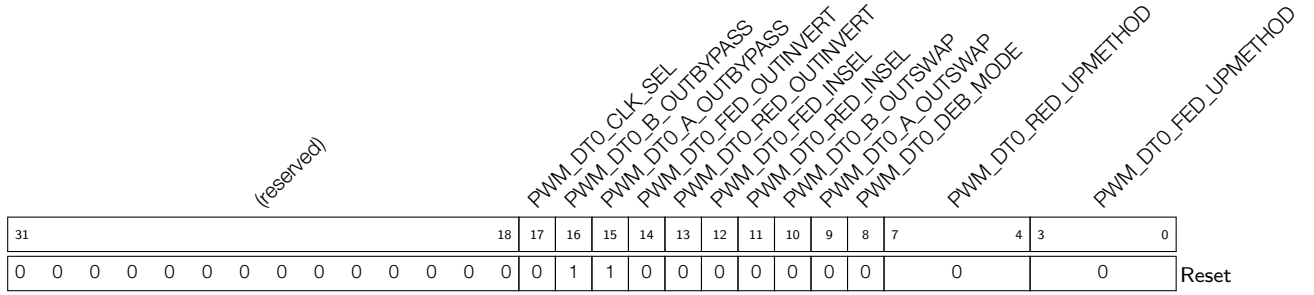
**PWM\_GEN0\_B\_UT0** Action on PWM0B triggered by event\_t0 when the timer increases. (R/W)

**PWM\_GEN0\_B\_UTEB** Action on PWM0B triggered by event TEB when the timer increases. (R/W)

**PWM\_GEN0\_B\_UTEA** Action on PWM0B triggered by event TEA when the timer increases. (R/W)

**PWM\_GEN0\_B\_UTEZ** Action on PWM0B triggered by event TEZ when the timer increases. (R/W)

**Register 16.23. PWM\_DT0\_CFG\_REG (0x0058)**



**PWM\_DT0\_CLK\_SEL** Dead time generator 0 clock selection. 0: PWM\_clk, 1: PT\_clk. (R/W)

**PWM\_DT0\_B\_OUTBYPASS** S0 in Table 16-5. (R/W)

**PWM\_DT0\_A\_OUTBYPASS** S1 in Table 16-5. (R/W)

**PWM\_DT0\_FED\_OUTINVERT** S3 in Table 16-5. (R/W)

**PWM\_DT0\_RED\_OUTINVERT** S2 in Table 16-5. (R/W)

**PWM\_DT0\_FED\_INSEL** S5 in Table 16-5. (R/W)

**PWM\_DT0\_RED\_INSEL** S4 in Table 16-5. (R/W)

**PWM\_DT0\_B\_OUTSWAP** S7 in Table 16-5. (R/W)

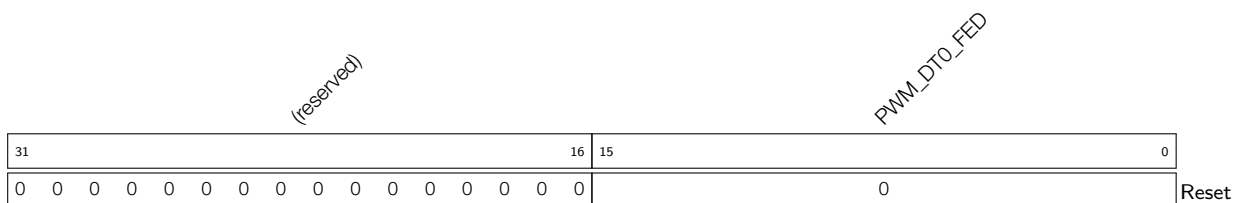
**PWM\_DT0\_A\_OUTSWAP** S6 in Table 16-5. (R/W)

**PWM\_DT0\_DEB\_MODE** S8 in Table 16-5, dual-edge B mode. 0: FED/RED take effect on different paths separately, 1: FED/RED take effect on B path. (R/W)

**PWM\_DT0\_RED\_UPMETHOD** Updating method for RED (rising edge delay) active register. 0: immediately; when bit0 is set to 1: TEZ; when bit1 is set to 1: TEP; when bit2 is set to 1: sync; when bit3 is set to 1: disable the update. (R/W)

**PWM\_DT0\_FED\_UPMETHOD** Updating method for FED (falling edge delay) active register. 0: immediately; when bit0 is set to 1: TEZ; when bit1 is set to 1: TEP; when bit2 is set to 1: sync; when bit3 is set to 1: disable the update. (R/W)

**Register 16.24. PWM\_DT0\_FED\_CFG\_REG (0x005c)**



**PWM\_DT0\_FED** Shadow register for FED. (R/W)

**Register 16.25. PWM\_DT0\_RED\_CFG\_REG (0x0060)**

(reserved)																PWM_DT0_RED															
31															16	15														0	
0																0															Reset

**PWM\_DT0\_RED** Shadow register for RED. (R/W)

**Register 16.26. PWM\_CARRIER0\_CFG\_REG (0x0064)**

(reserved)																PWM_CARRIER0_IN_INVERT		PWM_CARRIER0_OUT_INVERT		PWM_CARRIER0_OSHWTH		PWM_CARRIER0_DUTY		PWM_CARRIER0_PRESCALE		PWM_CARRIER0_EN				
31															14	13	12	11			8	7			5	4			1	0
0																0	0	0		0		0		0		0	0	0		0

**PWM\_CARRIER0\_IN\_INVERT** When set, invert the input of PWM0A and PWM0B for this submodule. (R/W)

**PWM\_CARRIER0\_OUT\_INVERT** When set, invert the output of PWM0A and PWM0B for this submodule. (R/W)

**PWM\_CARRIER0\_OSHWTH** Width of the first pulse in number of periods of the carrier. (R/W)

**PWM\_CARRIER0\_DUTY** Carrier duty selection. Duty = PWM\_CARRIER0\_DUTY/8. (R/W)

**PWM\_CARRIER0\_PRESCALE** PWM carrier0 clock (PC\_clk) prescale value. Period of PC\_clk = period of PWM\_clk \* (PWM\_CARRIER0\_PRESCALE + 1). (R/W)

**PWM\_CARRIER0\_EN** When set, carrier0 function is enabled. When cleared, carrier0 is bypassed. (R/W)

## Register 16.27. PWM\_FH0\_CFG0\_REG (0x0068)

(reserved)								PWM_FH0_B_OST_U	PWM_FH0_B_OST_D	PWM_FH0_B_CBC_U	PWM_FH0_B_CBC_D	PWM_FH0_A_OST_U	PWM_FH0_A_OST_D	PWM_FH0_A_CBC_U	PWM_FH0_A_CBC_D	PWM_FH0_F0_OST	PWM_FH0_F1_OST	PWM_FH0_F2_OST	PWM_FH0_SW_OST	PWM_FH0_F0_CBC	PWM_FH0_F1_CBC	PWM_FH0_F2_CBC	PWM_FH0_SW_CBC		
31	24	23	22	21	20	19	18	17	16	15	14	13	12	11	10	9	8	7	6	5	4	3	2	1	0
0	0	0	0	0	0	0	0	0	0	0	0	0	0	0	0	0	0	0	0	0	0	0	0	0	0

Reset

**PWM\_FH0\_B\_OST\_U** One-shot mode action on PWM0B when a fault event occurs and the timer is increasing. 0: do nothing, 1: force low, 2: force high, 3: toggle. (R/W)

**PWM\_FH0\_B\_OST\_D** One-shot mode action on PWM0B when a fault event occurs and the timer is decreasing. 0: do nothing, 1: force low, 2: force high, 3: toggle. (R/W)

**PWM\_FH0\_B\_CBC\_U** Cycle-by-cycle mode action on PWM0B when a fault event occurs and the timer is increasing. 0: do nothing, 1: force low, 2: force high, 3: toggle. (R/W)

**PWM\_FH0\_B\_CBC\_D** Cycle-by-cycle mode action on PWM0B when a fault event occurs and the timer is decreasing. 0: do nothing, 1: force low, 2: force high, 3: toggle. (R/W)

**PWM\_FH0\_A\_OST\_U** One-shot mode action on PWM0A when a fault event occurs and the timer is increasing. 0: do nothing, 1: force low, 2: force high, 3: toggle. (R/W)

**PWM\_FH0\_A\_OST\_D** One-shot mode action on PWM0A when a fault event occurs and the timer is decreasing. 0: do nothing, 1: force low, 2: force high, 3: toggle. (R/W)

**PWM\_FH0\_A\_CBC\_U** Cycle-by-cycle mode action on PWM0A when a fault event occurs and the timer is increasing. 0: do nothing, 1: force low, 2: force high, 3: toggle. (R/W)

**PWM\_FH0\_A\_CBC\_D** Cycle-by-cycle mode action on PWM0A when a fault event occurs and the timer is decreasing. 0: do nothing, 1: force low, 2: force high, 3: toggle. (R/W)

**PWM\_FH0\_F0\_OST** event\_f0 will trigger one-shot mode action. 0: disable, 1: enable. (R/W)

**PWM\_FH0\_F1\_OST** event\_f1 will trigger one-shot mode action. 0: disable, 1: enable. (R/W)

**PWM\_FH0\_F2\_OST** event\_f2 will trigger one-shot mode action. 0: disable, 1: enable. (R/W)

**PWM\_FH0\_SW\_OST** Enable register for software-forced one-shot mode action. 0: disable, 1: enable. (R/W)

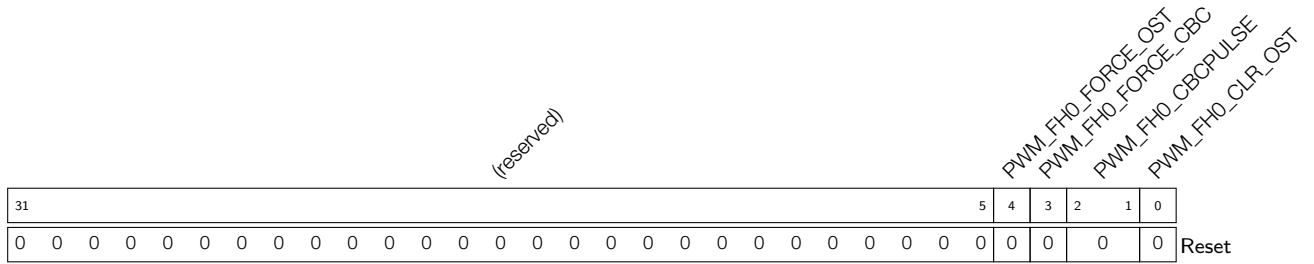
**PWM\_FH0\_F0\_CBC** event\_f0 will trigger cycle-by-cycle mode action. 0: disable, 1: enable. (R/W)

**PWM\_FH0\_F1\_CBC** event\_f1 will trigger cycle-by-cycle mode action. 0: disable, 1: enable. (R/W)

**PWM\_FH0\_F2\_CBC** event\_f2 will trigger cycle-by-cycle mode action. 0: disable, 1: enable. (R/W)

**PWM\_FH0\_SW\_CBC** Enable register for software-forced cycle-by-cycle mode action. 0: disable, 1: enable. (R/W)

**Register 16.28. PWM\_FH0\_CFG1\_REG (0x006c)**



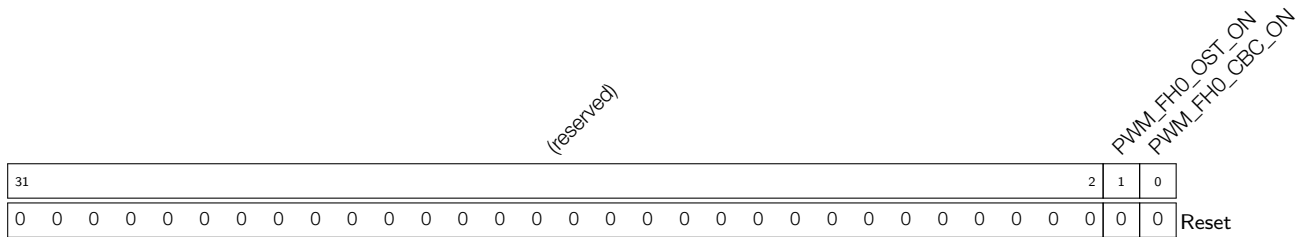
**PWM\_FH0\_FORCE\_OST** A toggle (software negation of this bit's value) triggers a one-shot mode action. (R/W)

**PWM\_FH0\_FORCE\_CBC** A toggle triggers a cycle-by-cycle mode action. (R/W)

**PWM\_FH0\_CBCPULSE** The cycle-by-cycle mode action refresh moment selection. When bit0 is set to 1: TEZ; when bit1 is set to 1: TEP. (R/W)

**PWM\_FH0\_CLR\_OST** A toggle will clear on-going one-shot mode action. (R/W)

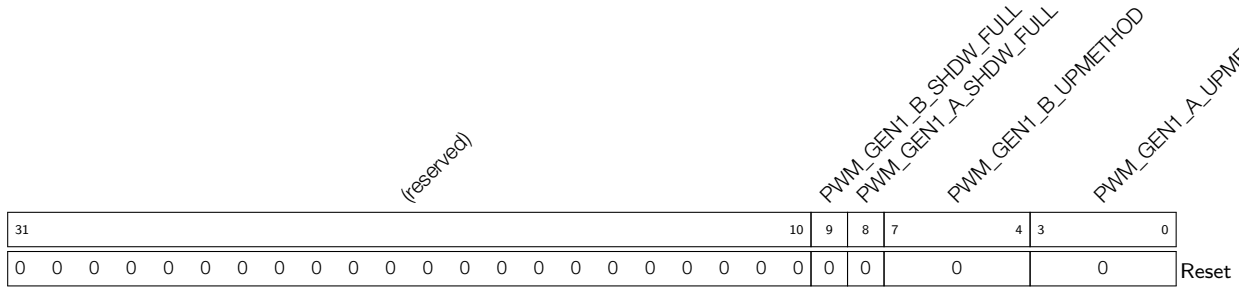
**Register 16.29. PWM\_FH0\_STATUS\_REG (0x0070)**



**PWM\_FH0\_OST\_ON** Set and reset by hardware. If set, a one-shot mode action is on-going. (RO)

**PWM\_FH0\_CBC\_ON** Set and reset by hardware. If set, a cycle-by-cycle mode action is on-going. (RO)

**Register 16.30. PWM\_GEN1\_STMP\_CFG\_REG (0x0074)**



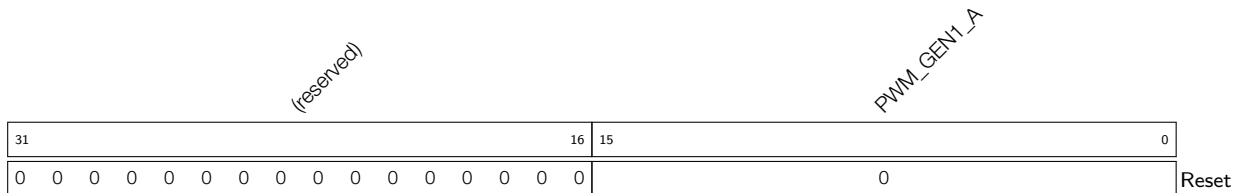
**PWM\_GEN1\_B\_SHDW\_FULL** Set and reset by hardware. If set, PWM generator 1 time stamp B’s shadow register is filled and to be transferred to time stamp B’s active register. If cleared, time stamp B’s active register has been updated with shadow register’s latest value. (RO)

**PWM\_GEN1\_A\_SHDW\_FULL** Set and reset by hardware. If set, PWM generator 1 time stamp A’s shadow register is filled and to be transferred to time stamp A’s active register. If cleared, time stamp A’s active register has been updated with shadow register latest value. (RO)

**PWM\_GEN1\_B\_UPMETHOD** Updating method for PWM generator 1 time stamp B’s active register.  
 0: immediately; when bit0 is set to 1: TEZ; when bit1 is set to 1: TEP; when bit2 is set to 1: sync; when bit3 is set to 1: disable the update. (R/W)

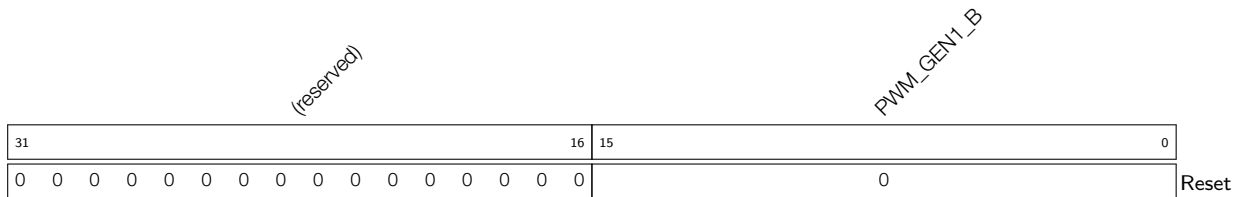
**PWM\_GEN1\_A\_UPMETHOD** Updating method for PWM generator 1 time stamp A’s active register.  
 0: immediately; when bit0 is set to 1: TEZ; when bit1 is set to 1: TEP; when bit2 is set to 1: sync; when bit3 is set to 1: disable the update. (R/W)

**Register 16.31. PWM\_GEN1\_TSTMP\_A\_REG (0x0078)**



**PWM\_GEN1\_A** PWM generator 1 time stamp A’s shadow register. (R/W)

**Register 16.32. PWM\_GEN1\_TSTMP\_B\_REG (0x007c)**



**PWM\_GEN1\_B** PWM generator 1 time stamp B’s shadow register. (R/W)



**Register 16.33. PWM\_GEN1\_CFG0\_REG (0x0080)**

(reserved)										PWM_GEN1_T1_SEL		PWM_GEN1_T0_SEL		PWM_GEN1_CFG_UPMETHOD				
31											10	9	7	6	4	3	0	
0	0	0	0	0	0	0	0	0	0	0	0	0	0	0	0	0	0	Reset

**PWM\_GEN1\_T1\_SEL** Source selection for PWM generator1 event\_t1, taking effect immediately, 0: fault\_event0, 1: fault\_event1, 2: fault\_event2, 3: sync\_taken, 4: none. (R/W)

**PWM\_GEN1\_T0\_SEL** Source selection for PWM generator1 event\_t0, taking effect immediately, 0: fault\_event0, 1: fault\_event1, 2: fault\_event2, 3: sync\_taken, 4: none. (R/W)

**PWM\_GEN1\_CFG\_UPMETHOD** Updating method for PWM generator1's active register of configuration. 0: immediately; when bit0 is set to 1: TEZ; when bit1 is set to 1: TEP; when bit2 is set to 1: sync. bit3: disable the update. (R/W)

**Register 16.34. PWM\_GEN1\_FORCE\_REG (0x0084)**

(reserved)																PWM_GEN1_B_NCIFORCE_MODE					PWM_GEN1_B_NCIFORCE					PWM_GEN1_A_NCIFORCE_MODE					PWM_GEN1_A_NCIFORCE					PWM_GEN1_B_CNTUFORCE_MODE					PWM_GEN1_A_CNTUFORCE_MODE					PWM_GEN1_CNTUFORCE_UPMETHOD				
31															16	15	14	13	12	11	10	9	8	7	6	5											0													
0																0					0					0					0					0x20					Reset									

**PWM\_GEN1\_B\_NCIFORCE\_MODE** Non-continuous immediate software-force mode for PWM1B.  
0: disabled, 1: low, 2: high, 3: disabled. (R/W)

**PWM\_GEN1\_B\_NCIFORCE** Trigger of non-continuous immediate software-force event for PWM1B;  
a toggle will trigger a force event. (R/W)

**PWM\_GEN1\_A\_NCIFORCE\_MODE** Non-continuous immediate software-force mode for PWM1A.  
0: disabled, 1: low, 2: high, 3: disabled. (R/W)

**PWM\_GEN1\_A\_NCIFORCE** Trigger of non-continuous immediate software-force event for PWM1A;  
a toggle will trigger a force event. (R/W)

**PWM\_GEN1\_B\_CNTUFORCE\_MODE** Continuous software-force mode for PWM1B. 0: disabled,  
1: low, 2: high, 3: disabled. (R/W)

**PWM\_GEN1\_A\_CNTUFORCE\_MODE** Continuous software-force mode for PWM1A. 0: disabled, 1:  
low, 2: high, 3: disabled. (R/W)

**PWM\_GEN1\_CNTUFORCE\_UPMETHOD** Updating method for continuous software force of PWM  
generator1. When all bits are set to 0: immediately; when bit0 is set to 1: TEZ; when bit1 is set  
to 1: TEP; when bit2 is set to 1: TEA; when bit3 is set to 1: TEB; when bit4 is set to 1: sync;  
when bit5 is set to 1: disable update. (TEA/B here and below means an event generated when  
the timer's value equals to that of register A/B). (R/W)

**Register 16.35. PWM\_GEN1\_A\_REG (0x0088)**

(reserved)								PWM_GEN1_A_DT1	PWM_GEN1_A_DT0	PWM_GEN1_A_DTEB	PWM_GEN1_A_DTEA	PWM_GEN1_A_DTEP	PWM_GEN1_A_DTEZ	PWM_GEN1_A_UT1	PWM_GEN1_A_UT0	PWM_GEN1_A_UTEB	PWM_GEN1_A_UTEA	PWM_GEN1_A_UTEP	PWM_GEN1_A_UTEZ						
31	24	23	22	21	20	19	18	17	16	15	14	13	12	11	10	9	8	7	6	5	4	3	2	1	0
0	0	0	0	0	0	0	0	0	0	0	0	0	0	0	0	0	0	0	0	0	0	0	0	0	0

Reset

**PWM\_GEN1\_A\_DT1** Action on PWM1A triggered by event\_t1 when the timer decreases. 0: no change, 1: low, 2: high, 3: toggle. (R/W)

**PWM\_GEN1\_A\_DT0** Action on PWM1A triggered by event\_t0 when the timer decreases. (R/W)

**PWM\_GEN1\_A\_DTEB** Action on PWM1A triggered by event TEB when the timer decreases. (R/W)

**PWM\_GEN1\_A\_DTEA** Action on PWM1A triggered by event TEA when the timer decreases. (R/W)

**PWM\_GEN1\_A\_DTEP** Action on PWM1A triggered by event TEP when the timer decreases. (R/W)

**PWM\_GEN1\_A\_DTEZ** Action on PWM1A triggered by event TEZ when the timer decreases. (R/W)

**PWM\_GEN1\_A\_UT1** Action on PWM1A triggered by event\_t1 when the timer increases. (R/W)

**PWM\_GEN1\_A\_UT0** Action on PWM1A triggered by event\_t0 when the timer increases. (R/W)

**PWM\_GEN1\_A\_UTEB** Action on PWM1A triggered by event TEB when the timer increases. (R/W)

**PWM\_GEN1\_A\_UTEA** Action on PWM1A triggered by event TEA when the timer increases. (R/W)

**PWM\_GEN1\_A\_UTEP** Action on PWM1A triggered by event TEP when the timer increases. (R/W)

**PWM\_GEN1\_A\_UTEZ** Action on PWM1A triggered by event TEZ when the timer increases. (R/W)

**Register 16.36. PWM\_GEN1\_B\_REG (0x008c)**

(reserved)								PWM_GEN1_B_DT1	PWM_GEN1_B_DT0	PWM_GEN1_B_DTEB	PWM_GEN1_B_DTEA	PWM_GEN1_B_DTEP	PWM_GEN1_B_DTEZ	PWM_GEN1_B_UT1	PWM_GEN1_B_UT0	PWM_GEN1_B_UTEB	PWM_GEN1_B_UTEA	PWM_GEN1_B_UTEP	PWM_GEN1_B_UTEZ						
31	24	23	22	21	20	19	18	17	16	15	14	13	12	11	10	9	8	7	6	5	4	3	2	1	0
0	0	0	0	0	0	0	0	0	0	0	0	0	0	0	0	0	0	0	0	0	0	0	0	0	0

Reset

**PWM\_GEN1\_B\_DT1** Action on PWM1B triggered by event\_t1 when the timer decreases. 0: no change, 1: low, 2: high, 3: toggle. (R/W)

**PWM\_GEN1\_B\_DT0** Action on PWM1B triggered by event\_t0 when the timer decreases. (R/W)

**PWM\_GEN1\_B\_DTEB** Action on PWM1B triggered by event TEB when the timer decreases. (R/W)

**PWM\_GEN1\_B\_DTEA** Action on PWM1B triggered by event TEA when the timer decreases. (R/W)

**PWM\_GEN1\_B\_DTEP** Action on PWM1B triggered by event TEP when the timer decreases. (R/W)

**PWM\_GEN1\_B\_DTEZ** Action on PWM1B triggered by event TEZ when the timer decreases. (R/W)

**PWM\_GEN1\_B\_UT1** Action on PWM1B triggered by event\_t1 when the timer increases. (R/W)

**PWM\_GEN1\_B\_UT0** Action on PWM1B triggered by event\_t0 when the timer increases. (R/W)

**PWM\_GEN1\_B\_UTEB** Action on PWM1B triggered by event TEB when the timer increases. (R/W)

**PWM\_GEN1\_B\_UTEA** Action on PWM1B triggered by event TEA when the timer increases. (R/W)

**PWM\_GEN1\_B\_UTEP** Action on PWM1B triggered by event TEP when the timer increases. (R/W)

**PWM\_GEN1\_B\_UTEZ** Action on PWM1B triggered by event TEZ when the timer increases. (R/W)

**Register 16.37. PWM\_DT1\_CFG\_REG (0x0090)**

(reserved)																		PWM_DT1_CLK_SEL	PWM_DT1_B_OUTBYPASS	PWM_DT1_A_OUTBYPASS	PWM_DT1_FED_OUTINVERT	PWM_DT1_RED_OUTINVERT	PWM_DT1_FED_INSEL	PWM_DT1_RED_INSEL	PWM_DT1_B_OUTSWAP	PWM_DT1_A_OUTSWAP	PWM_DT1_DEB_MODE	PWM_DT1_RED_UPMETHOD			PWM_DT1_FED_UPMETHOD																		
31																		18	17	16	15	14	13	12	11	10	9	8	7				4	3	0														
0																		0	1	1	0	0	0	0	0	0	0	0	0	0	0	0	0	0	0	0	0	0	0	0	0	0	0	0	0	0	0	0	Reset

**PWM\_DT1\_CLK\_SEL** Dead time generator 1 clock selection. 0: PWM\_clk, 1: PT\_clk. (R/W)

**PWM\_DT1\_B\_OUTBYPASS** S0 in Table 16-5. (R/W)

**PWM\_DT1\_A\_OUTBYPASS** S1 in Table 16-5. (R/W)

**PWM\_DT1\_FED\_OUTINVERT** S3 in Table 16-5. (R/W)

**PWM\_DT1\_RED\_OUTINVERT** S2 in Table 16-5. (R/W)

**PWM\_DT1\_FED\_INSEL** S5 in Table 16-5. (R/W)

**PWM\_DT1\_RED\_INSEL** S4 in Table 16-5. (R/W)

**PWM\_DT1\_B\_OUTSWAP** S7 in Table 16-5. (R/W)

**PWM\_DT1\_A\_OUTSWAP** S6 in Table 16-5. (R/W)

**PWM\_DT1\_DEB\_MODE** S8 in Table 16-5; dual-edge B mode. 0: FED/RED take effect on different paths separately; 1: FED (falling edge delay)/RED (rising edge delay) take effect on B path. (R/W)

**PWM\_DT1\_RED\_UPMETHOD** Updating method for RED active register. 0: immediately; when bit0 is set to 1: TEZ; when bit1 is set to 1: TEP; when bit2 is set to 1: sync; when bit3 is set to 1: disable the update. (R/W)

**PWM\_DT1\_FED\_UPMETHOD** Updating method for FED active register. 0: immediately; when bit0 is set to 1: TEZ; when bit1 is set to 1: TEP; when bit2 is set to 1: sync; when bit3 is set to 1: disable the update. (R/W)

**Register 16.38. PWM\_DT1\_FED\_CFG\_REG (0x0094)**

(reserved)																PWM_DT1_FED		
31																16	15	0
0																0	0	Reset

**PWM\_DT1\_FED** Shadow register for FED. (R/W)

**Register 16.39. PWM\_DT1\_RED\_CFG\_REG (0x0098)**

(reserved)																PWM_DT1_RED															
31															16	15														0	
0																0															Reset

**PWM\_DT1\_RED** Shadow register for RED. (R/W)

**Register 16.40. PWM\_CARRIER1\_CFG\_REG (0x009c)**

(reserved)																PWM_CARRIER1_IN_INVERT		PWM_CARRIER1_OUT_INVERT		PWM_CARRIER1_OSHWTH		PWM_CARRIER1_DUTY		PWM_CARRIER1_PRESCALE		PWM_CARRIER1_EN				
31															14	13	12	11			8	7			5	4			1	0
0																0		0		0		0		0		0		0		Reset

**PWM\_CARRIER1\_IN\_INVERT** When set, invert the input of PWM1A and PWM1B for this submodule. (R/W)

**PWM\_CARRIER1\_OUT\_INVERT** When set, invert the output of PWM1A and PWM1B for this submodule. (R/W)

**PWM\_CARRIER1\_OSHWTH** Width of the first pulse in number of periods of the carrier. (R/W)

**PWM\_CARRIER1\_DUTY** Carrier duty selection. Duty = PWM\_CARRIER1\_DUTY/8. (R/W)

**PWM\_CARRIER1\_PRESCALE** PWM carrier1 clock (PC\_clk) prescale value. Period of PC\_clk = period of PWM\_clk \* (PWM\_CARRIER1\_PRESCALE + 1). (R/W)

**PWM\_CARRIER1\_EN** When set, carrier1 function is enabled. When cleared, carrier1 is bypassed. (R/W)

**Register 16.41. PWM\_FH1\_CFG0\_REG (0x00a0)**

(reserved)								PWM_FH1_B_OST_U		PWM_FH1_B_OST_D		PWM_FH1_B_CBC_U		PWM_FH1_B_CBC_D		PWM_FH1_A_OST_U		PWM_FH1_A_OST_D		PWM_FH1_A_CBC_U		PWM_FH1_A_CBC_D		PWM_FH1_F0_OST		PWM_FH1_F1_OST		PWM_FH1_F2_OST		PWM_FH1_SW_OST		PWM_FH1_F0_CBC		PWM_FH1_F1_CBC		PWM_FH1_F2_CBC		PWM_FH1_SW_CBC			
31	30	29	28	27	26	25	24	23	22	21	20	19	18	17	16	15	14	13	12	11	10	9	8	7	6	5	4	3	2	1	0	Reset									
0	0	0	0	0	0	0	0	0	0	0	0	0	0	0	0	0	0	0	0	0	0	0	0	0	0	0	0	0	0	0	0	0	0	0	0	0	0	0	0	0	0

**PWM\_FH1\_B\_OST\_U** One-shot mode action on PWM1B when a fault event occurs and the timer is increasing. 0: do nothing, 1: force low, 2: force high, 3: toggle. (R/W)

**PWM\_FH1\_B\_OST\_D** One-shot mode action on PWM1B when a fault event occurs and the timer is decreasing. 0: do nothing, 1: force low, 2: force high, 3: toggle. (R/W)

**PWM\_FH1\_B\_CBC\_U** Cycle-by-cycle mode action on PWM1B when a fault event occurs and the timer is increasing. 0: do nothing, 1: force low, 2: force high, 3: toggle. (R/W)

**PWM\_FH1\_B\_CBC\_D** Cycle-by-cycle mode action on PWM1B when a fault event occurs and the timer is decreasing. 0: do nothing, 1: force low, 2: force high, 3: toggle. (R/W)

**PWM\_FH1\_A\_OST\_U** One-shot mode action on PWM1A when a fault event occurs and the timer is increasing. 0: do nothing, 1: force low, 2: force high, 3: toggle. (R/W)

**PWM\_FH1\_A\_OST\_D** One-shot mode action on PWM1A when a fault event occurs and the timer is decreasing. 0: do nothing, 1: force low, 2: force high, 3: toggle. (R/W)

**PWM\_FH1\_A\_CBC\_U** Cycle-by-cycle mode action on PWM1A when a fault event occurs and the timer is increasing. 0: do nothing, 1: force low, 2: force high, 3: toggle. (R/W)

**PWM\_FH1\_A\_CBC\_D** Cycle-by-cycle mode action on PWM1A when a fault event occurs and the timer is decreasing. 0: do nothing, 1: force low, 2: force high, 3: toggle. (R/W)

**PWM\_FH1\_F0\_OST** Enable event\_f0 to trigger one-shot mode action. 0: disable, 1: enable. (R/W)

**PWM\_FH1\_F1\_OST** Enable event\_f1 to trigger one-shot mode action. 0: disable, 1: enable. (R/W)

**PWM\_FH1\_F2\_OST** Enable event\_f2 to trigger one-shot mode action. 0: disable, 1: enable. (R/W)

**PWM\_FH1\_SW\_OST** Enable the register for software-forced one-shot mode action. 0: disable, 1: enable. (R/W)

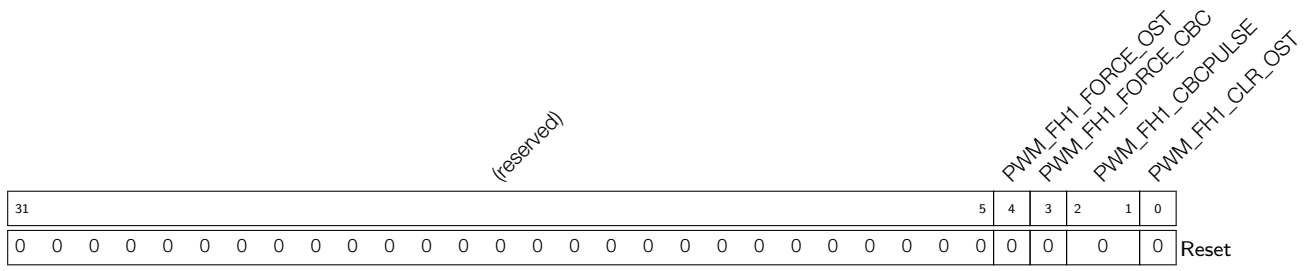
**PWM\_FH1\_F0\_CBC** Enable event\_f0 to trigger cycle-by-cycle mode action. 0: disable, 1: enable. (R/W)

**PWM\_FH1\_F1\_CBC** Enable event\_f1 to trigger cycle-by-cycle mode action. 0: disable, 1: enable. (R/W)

**PWM\_FH1\_F2\_CBC** Enable event\_f2 to will trigger cycle-by-cycle mode action. 0: disable, 1: enable. (R/W)

**PWM\_FH1\_SW\_CBC** Enable the register for software-forced cycle-by-cycle mode action. 0: disable, 1: enable. (R/W)

**Register 16.42. PWM\_FH1\_CFG1\_REG (0x00a4)**



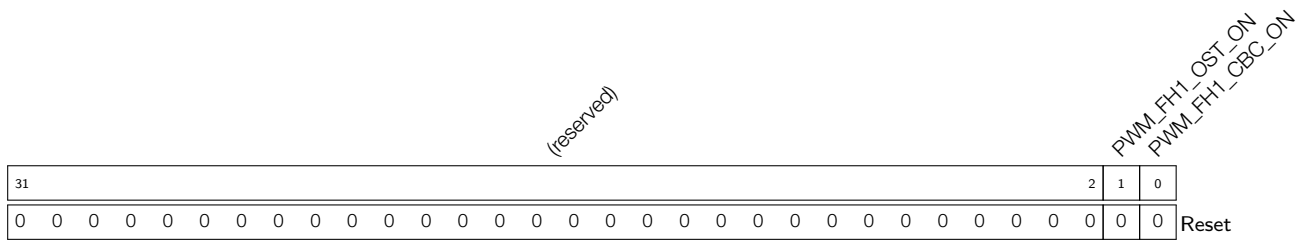
**PWM\_FH1\_FORCE\_OST** A toggle (software negation of this bit's value) triggers a one-shot mode action. (R/W)

**PWM\_FH1\_FORCE\_CBC** A toggle triggers a cycle-by-cycle mode action. (R/W)

**PWM\_FH1\_CBCPULSE** The cycle-by-cycle mode action refresh moment selection. When bit0 is set to 1: TEZ; when bit1 is set to 1: TEP. (R/W)

**PWM\_FH1\_CLR\_OST** A toggle will clear on-going one-shot mode action. (R/W)

**Register 16.43. PWM\_FH1\_STATUS\_REG (0x00a8)**

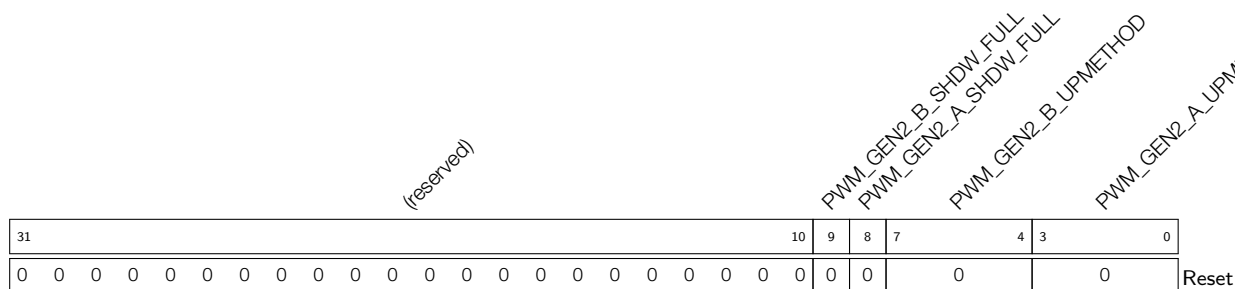


**PWM\_FH1\_OST\_ON** Set and reset by hardware. If set, a one-shot mode action is on-going. (RO)

**PWM\_FH1\_CBC\_ON** Set and reset by hardware. If set, a cycle-by-cycle mode action is on-going. (RO)



**Register 16.44. PWM\_GEN2\_STMP\_CFG\_REG (0x00ac)**



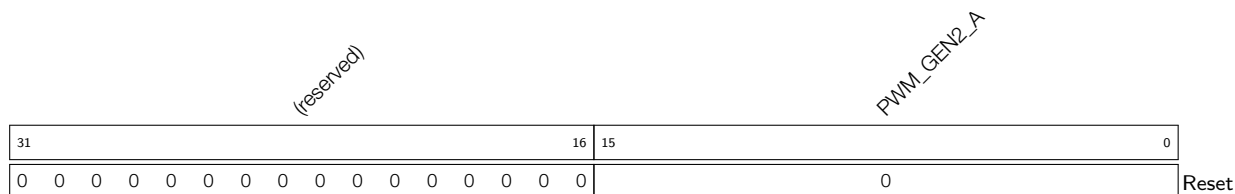
**PWM\_GEN2\_B\_SHDW\_FULL** Set and reset by hardware. If set, PWM generator 2 time stamp B’s shadow register is filled and to be transferred to time stamp B’s active register. If cleared, time stamp B’s active register has been updated with shadow register’s latest value. (RO)

**PWM\_GEN2\_A\_SHDW\_FULL** Set and reset by hardware. If set, PWM generator 2 time stamp A’s shadow register is filled and to be transferred to time stamp A’s active register. If cleared, time stamp A’s active register has been updated with shadow register’s latest value. (RO)

**PWM\_GEN2\_B\_UPMETHOD** Updating method for PWM generator 2 time stamp B’s active register.  
 0: immediately; when bit0 is set to 1: TEZ; when bit1 is set to 1: TEP; when bit2 is set to 1: sync; when bit3 is set to 1: disable the update. (R/W)

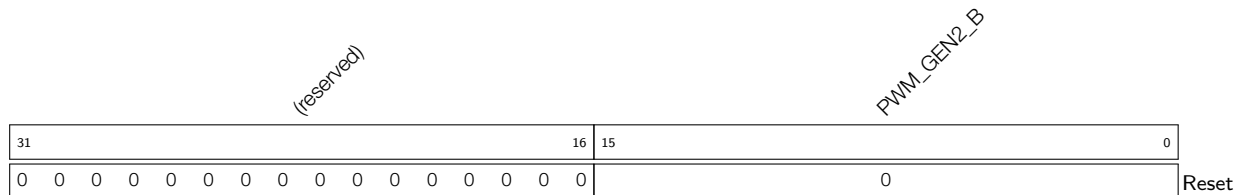
**PWM\_GEN2\_A\_UPMETHOD** Updating method for PWM generator 2 time stamp A’s active register.  
 0: immediately; when bit0 is set to 1: TEZ; when bit1 is set to 1: TEP; when bit2 is set to 1: sync; when bit3 is set to 1: disable the update. (R/W)

**Register 16.45. PWM\_GEN2\_TSTMP\_A\_REG (0x00b0)**

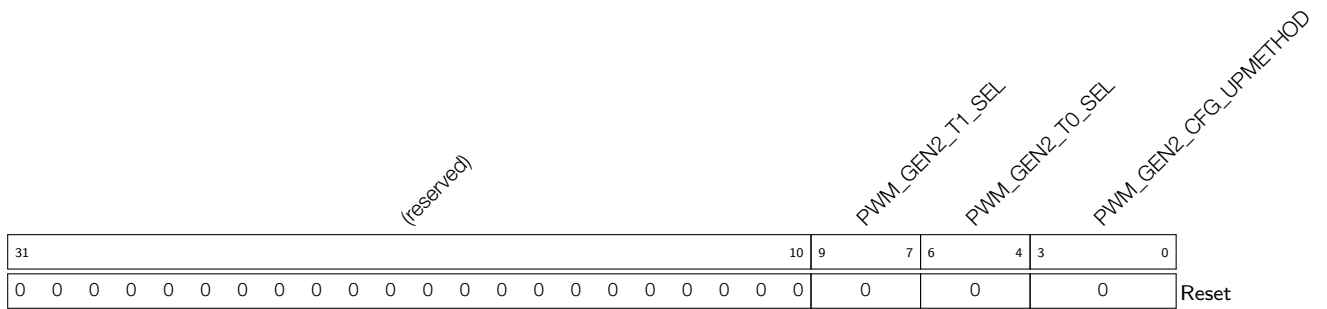


**PWM\_GEN2\_A** PWM generator 2 time stamp A’s shadow register. (R/W)

**Register 16.46. PWM\_GEN2\_TSTMP\_B\_REG (0x00b4)**



**PWM\_GEN2\_B** PWM generator 2 time stamp B’s shadow register. (R/W)

**Register 16.47. PWM\_GEN2\_CFG0\_REG (0x00b8)**

**PWM\_GEN2\_T1\_SEL** Source selection for PWM generator2 event\_t1, take effect immediately, 0: fault\_event0, 1: fault\_event1, 2: fault\_event2, 3: sync\_taken, 4: none. (R/W)

**PWM\_GEN2\_T0\_SEL** Source selection for PWM generator2 event\_t0, take effect immediately, 0: fault\_event0, 1: fault\_event1, 2: fault\_event2, 3: sync\_taken, 4: none. (R/W)

**PWM\_GEN2\_CFG\_UPMETHOD** Updating method for PWM generator2's active register of configuration. 0: immediately; when bit0 is set to 1: TEZ; when bit1 is set to 1: TEP; when bit2 is set to 1: sync. bit3: disable the update. (R/W)

**Register 16.48. PWM\_GEN2\_FORCE\_REG (0x00bc)**

(reserved)																PWM_GEN2_B_NCIFORCE_MODE	PWM_GEN2_B_NCIFORCE	PWM_GEN2_A_NCIFORCE_MODE	PWM_GEN2_A_NCIFORCE	PWM_GEN2_B_CNTUFORCE_MODE	PWM_GEN2_A_CNTUFORCE_MODE	PWM_GEN2_CNTUFORCE_UPMETHOD							
31													16	15	14	13	12	11	10	9	8	7	6	5					0
0																0	0	0	0	0	0	0	0	0x20				Reset	

**PWM\_GEN2\_B\_NCIFORCE\_MODE** Non-continuous immediate software-force mode for PWM2B, 0: disabled, 1: low, 2: high, 3: disabled. (R/W)

**PWM\_GEN2\_B\_NCIFORCE** Trigger of non-continuous immediate software-force event for PWM2B, a toggle will trigger a force event. (R/W)

**PWM\_GEN2\_A\_NCIFORCE\_MODE** Non-continuous immediate software-force mode for PWM2A, 0: disabled, 1: low, 2: high, 3: disabled. (R/W)

**PWM\_GEN2\_A\_NCIFORCE** Trigger of non-continuous immediate software-force event for PWM2A, a toggle will trigger a force event. (R/W)

**PWM\_GEN2\_B\_CNTUFORCE\_MODE** Continuous software-force mode for PWM2B. 0: disabled, 1: low, 2: high, 3: disabled. (R/W)

**PWM\_GEN2\_A\_CNTUFORCE\_MODE** Continuous software-force mode for PWM2A. 0: disabled, 1: low, 2: high, 3: disabled. (R/W)

**PWM\_GEN2\_CNTUFORCE\_UPMETHOD** Updating method for continuous software force of PWM generator2. 0: immediately; when bit0 is set to 1: TEZ; when bit1 is set to 1: TEP; when bit2 is set to 1: TEA; when bit3 is set to 1: TEB; when bit4 is set to 1: sync; when bit5 is set to 1: disable update. (TEA/B here and below means an event generated when the timer value equals that of register A/B.) (R/W)

**Register 16.49. PWM\_GEN2\_A\_REG (0x00c0)**

(reserved)								PWM_GEN2_A_DT1		PWM_GEN2_A_DT0		PWM_GEN2_A_DTEB		PWM_GEN2_A_DTEA		PWM_GEN2_A_DTEP		PWM_GEN2_A_DTEZ		PWM_GEN2_A_UT1		PWM_GEN2_A_UT0		PWM_GEN2_A_UTEB		PWM_GEN2_A_UTEA		PWM_GEN2_A_UTEZ					
31	30	29	28	27	26	25	24	23	22	21	20	19	18	17	16	15	14	13	12	11	10	9	8	7	6	5	4	3	2	1	0		
0	0	0	0	0	0	0	0	0	0	0	0	0	0	0	0	0	0	0	0	0	0	0	0	0	0	0	0	0	0	0	0	0	0

Reset

**PWM\_GEN2\_A\_DT1** Action on PWM2A triggered by event\_t1 when the timer decreases. 0: no change, 1: low, 2: high, 3: toggle. (R/W)

**PWM\_GEN2\_A\_DT0** Action on PWM2A triggered by event\_t0 when the timer decreases. (R/W)

**PWM\_GEN2\_A\_DTEB** Action on PWM2A triggered by event TEB when the timer decreases. (R/W)

**PWM\_GEN2\_A\_DTEA** Action on PWM2A triggered by event TEA when the timer decreases. (R/W)

**PWM\_GEN2\_A\_DTEP** Action on PWM2A triggered by event TEP when the timer decreases. (R/W)

**PWM\_GEN2\_A\_DTEZ** Action on PWM2A triggered by event TEZ when the timer decreases. (R/W)

**PWM\_GEN2\_A\_UT1** Action on PWM2A triggered by event\_t1 when the timer increases. (R/W)

**PWM\_GEN2\_A\_UT0** Action on PWM2A triggered by event\_t0 when the timer increases. (R/W)

**PWM\_GEN2\_A\_UTEB** Action on PWM2A triggered by event TEB when the timer increases. (R/W)

**PWM\_GEN2\_A\_UTEA** Action on PWM2A triggered by event TEA when the timer increases. (R/W)

**PWM\_GEN2\_A\_UTEZ** Action on PWM2A triggered by event TEZ when the timer increases. (R/W)

**Register 16.50. PWM\_GEN2\_B\_REG (0x00c4)**

(reserved)								PWM_GEN2_B_DT1	PWM_GEN2_B_DT0	PWM_GEN2_B_DTEB	PWM_GEN2_B_DTEA	PWM_GEN2_B_DTEP	PWM_GEN2_B_DTEZ	PWM_GEN2_B_UT1	PWM_GEN2_B_UT0	PWM_GEN2_B_UTEB	PWM_GEN2_B_UTEA	PWM_GEN2_B_UTEP	PWM_GEN2_B_UTEZ														
31	30	29	28	27	26	25	24	23	22	21	20	19	18	17	16	15	14	13	12	11	10	9	8	7	6	5	4	3	2	1	0		
0	0	0	0	0	0	0	0	0	0	0	0	0	0	0	0	0	0	0	0	0	0	0	0	0	0	0	0	0	0	0	0	0	Reset

**PWM\_GEN2\_B\_DT1** Action on PWM2B triggered by event\_t1 when the timer decreases. 0: no change, 1: low, 2: high, 3: toggle. (R/W)

**PWM\_GEN2\_B\_DT0** Action on PWM2B triggered by event\_t0 when the timer decreases. (R/W)

**PWM\_GEN2\_B\_DTEB** Action on PWM2B triggered by event TEB when the timer decreases. (R/W)

**PWM\_GEN2\_B\_DTEA** Action on PWM2B triggered by event TEA when the timer decreases. (R/W)

**PWM\_GEN2\_B\_DTEP** Action on PWM2B triggered by event TEP when the timer decreases. (R/W)

**PWM\_GEN2\_B\_DTEZ** Action on PWM2B triggered by event TEZ when the timer decreases. (R/W)

**PWM\_GEN2\_B\_UT1** Action on PWM2B triggered by event\_t1 when the timer increases. (R/W)

**PWM\_GEN2\_B\_UT0** Action on PWM2B triggered by event\_t0 when the timer increases. (R/W)

**PWM\_GEN2\_B\_UTEB** Action on PWM2B triggered by event TEB when the timer increases. (R/W)

**PWM\_GEN2\_B\_UTEA** Action on PWM2B triggered by event TEA when the timer increases. (R/W)

**PWM\_GEN2\_B\_UTEP** Action on PWM2B triggered by event TEP when the timer increases. (R/W)

**PWM\_GEN2\_B\_UTEZ** Action on PWM2B triggered by event TEZ when the timer increases. (R/W)

**Register 16.51. PWM\_DT2\_CFG\_REG (0x00c8)**

(reserved)																		PWM_DT2_CLK_SEL		PWM_DT2_B_OUTBYPASS		PWM_DT2_A_OUTBYPASS		PWM_DT2_FED_OUTINVERT		PWM_DT2_RED_OUTINVERT		PWM_DT2_FED_INSEL		PWM_DT2_RED_INSEL		PWM_DT2_B_OUTSWAP		PWM_DT2_A_OUTSWAP		PWM_DT2_DEB_MODE		PWM_DT2_RED_UPMETHOD		PWM_DT2_FED_UPMETHOD	
31																		18	17	16	15	14	13	12	11	10	9	8	7	4	3	0									
0																		0		1		1		0		0		0		0		0		0		0		0		Reset	

**PWM\_DT2\_CLK\_SEL** Dead time generator 1 clock selection. 0: PWM\_clk; 1: PT\_clk. (R/W)

**PWM\_DT2\_B\_OUTBYPASS** S0 in Table 16-5. (R/W)

**PWM\_DT2\_A\_OUTBYPASS** S1 in Table 16-5. (R/W)

**PWM\_DT2\_FED\_OUTINVERT** S3 in Table 16-5. (R/W)

**PWM\_DT2\_RED\_OUTINVERT** S2 in Table 16-5. (R/W)

**PWM\_DT2\_FED\_INSEL** S5 in Table 16-5. (R/W)

**PWM\_DT2\_RED\_INSEL** S4 in Table 16-5. (R/W)

**PWM\_DT2\_B\_OUTSWAP** S7 in Table 16-5. (R/W)

**PWM\_DT2\_A\_OUTSWAP** S6 in Table 16-5. (R/W)

**PWM\_DT2\_DEB\_MODE** S8 in Table 16-5, dual-edge B mode, 0: FED/RED take effect on different path separately, 1: FED/RED take effect on B path. (R/W)

**PWM\_DT2\_RED\_UPMETHOD** Updating method for RED (rising edge delay) active register. 0: immediately; when bit0 is set to 1: TEZ; when bit1 is set to 1: TEP; when bit2 is set to 1: sync; when bit3 is set to 1: disable the update. (R/W)

**PWM\_DT2\_FED\_UPMETHOD** Updating method for FED (falling edge delay) active register. 0: immediately; when bit0 is set to 1: TEZ; when bit1 is set to 1: TEP; when bit2 is set to 1: sync; when bit3 is set to 1: disable the update. (R/W)

**Register 16.52. PWM\_DT2\_FED\_CFG\_REG (0x00cc)**

(reserved)																PWM_DT2_FED			
31																	16	15	0
0																0		Reset	

**PWM\_DT2\_FED** Shadow register for FED. (R/W)

**Register 16.53. PWM\_DT2\_RED\_CFG\_REG (0x00d0)**

(reserved)																PWM_DT2_RED															
31															16	15														0	
0																0															Reset

**PWM\_DT2\_RED** Shadow register for RED. (R/W)

**Register 16.54. PWM\_CARRIER2\_CFG\_REG (0x00d4)**

(reserved)																PWM_CARRIER2_IN_INVERT		PWM_CARRIER2_OUT_INVERT		PWM_CARRIER2_OSHWTH		PWM_CARRIER2_DUTY		PWM_CARRIER2_PRESCALE		PWM_CARRIER2_EN						
31															14	13	12	11			8	7			5	4			1	0		
0																0		0		0		0		0		0		0		0		Reset

**PWM\_CARRIER2\_IN\_INVERT** When set, invert the input of PWM2A and PWM2B for this submodule. (R/W)

**PWM\_CARRIER2\_OUT\_INVERT** When set, invert the output of PWM2A and PWM2B for this submodule. (R/W)

**PWM\_CARRIER2\_OSHWTH** Width of the first pulse in number of periods of the carrier. (R/W)

**PWM\_CARRIER2\_DUTY** Carrier duty selection. Duty = PWM\_CARRIER2\_DUTY / 8. (R/W)

**PWM\_CARRIER2\_PRESCALE** PWM carrier2 clock (PC\_clk) prescale value. Period of PC\_clk = period of PWM\_clk \* (PWM\_CARRIER2\_PRESCALE + 1). (R/W)

**PWM\_CARRIER2\_EN** When set, carrier2 function is enabled. When cleared, carrier2 is bypassed. (R/W)

**Register 16.55. PWM\_FH2\_CFG0\_REG (0x00d8)**

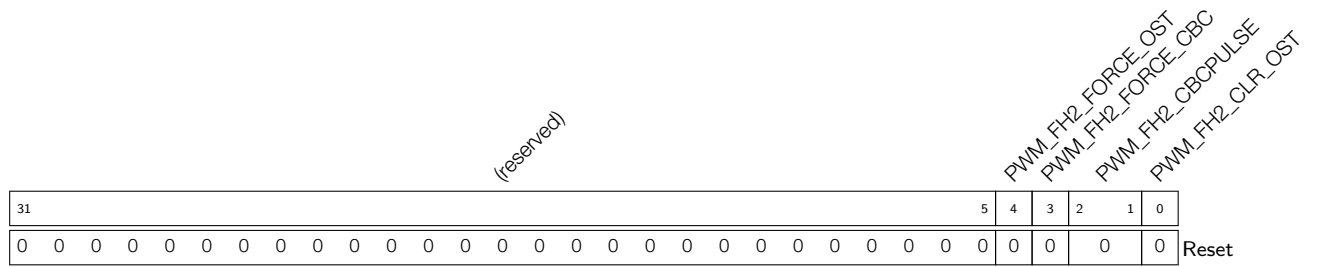
<i>(reserved)</i>				<i>PWM_FH2_B_OST_U PWM_FH2_B_OST_D PWM_FH2_B_CBC_U PWM_FH2_B_CBC_D PWM_FH2_A_OST_U PWM_FH2_A_OST_D PWM_FH2_A_CBC_U PWM_FH2_A_CBC_D PWM_FH2_F0_OST PWM_FH2_F1_OST PWM_FH2_F2_OST PWM_FH2_SW_OST PWM_FH2_F0_CBC PWM_FH2_F1_CBC PWM_FH2_F2_CBC PWM_FH2_SW_CBC</i>																						
31	24	23	22	21	20	19	18	17	16	15	14	13	12	11	10	9	8	7	6	5	4	3	2	1	0	
0	0	0	0	0	0	0	0	0	0	0	0	0	0	0	0	0	0	0	0	0	0	0	0	0	0	0

Reset

- PWM\_FH2\_B\_OST\_U** One-shot mode action on PWM2B when a fault event occurs and the timer is increasing. 0: do nothing, 1: force low, 2: force high, 3: toggle. (R/W)
- PWM\_FH2\_B\_OST\_D** One-shot mode action on PWM2B when a fault event occurs and the timer is decreasing. 0: do nothing, 1: force low, 2: force high, 3: toggle. (R/W)
- PWM\_FH2\_B\_CBC\_U** Cycle-by-cycle mode action on PWM2B when a fault event occurs and the timer is increasing. 0: do nothing, 1: force low, 2: force high, 3: toggle. (R/W)
- PWM\_FH2\_B\_CBC\_D** Cycle-by-cycle mode action on PWM2B when a fault event occurs and the timer is decreasing. 0: do nothing, 1: force low, 2: force high, 3: toggle. (R/W)
- PWM\_FH2\_A\_OST\_U** One-shot mode action on PWM2A when a fault event occurs and the timer is increasing. 0: do nothing, 1: force low, 2: force high, 3: toggle. (R/W)
- PWM\_FH2\_A\_OST\_D** One-shot mode action on PWM2A when a fault event occurs and the timer is decreasing. 0: do nothing, 1: force low, 2: force high, 3: toggle. (R/W)
- PWM\_FH2\_A\_CBC\_U** Cycle-by-cycle mode action on PWM2A when a fault event occurs and the timer is increasing. 0: do nothing, 1: force low, 2: force high, 3: toggle. (R/W)
- PWM\_FH2\_A\_CBC\_D** Cycle-by-cycle mode action on PWM2A when a fault event occurs and the timer is decreasing. 0: do nothing, 1: force low, 2: force high, 3: toggle. (R/W)
- PWM\_FH2\_F0\_OST** event\_f0 will trigger one-shot mode action. 0: disable, 1: enable. (R/W)
- PWM\_FH2\_F1\_OST** event\_f1 will trigger one-shot mode action. 0: disable, 1: enable. (R/W)
- PWM\_FH2\_F2\_OST** event\_f2 will trigger one-shot mode action. 0: disable, 1: enable. (R/W)
- PWM\_FH2\_SW\_OST** Enable register for software-forced one-shot mode action. 0: disable, 1: enable. (R/W)
- PWM\_FH2\_F0\_CBC** event\_f0 will trigger cycle-by-cycle mode action. 0: disable, 1: enable. (R/W)
- PWM\_FH2\_F1\_CBC** event\_f1 will trigger cycle-by-cycle mode action. 0: disable, 1: enable. (R/W)
- PWM\_FH2\_F2\_CBC** event\_f2 will trigger cycle-by-cycle mode action. 0: disable, 1: enable. (R/W)
- PWM\_FH2\_SW\_CBC** Enable register for software-forced cycle-by-cycle mode action. 0: disable, 1: enable. (R/W)



**Register 16.56. PWM\_FH2\_CFG1\_REG (0x00dc)**



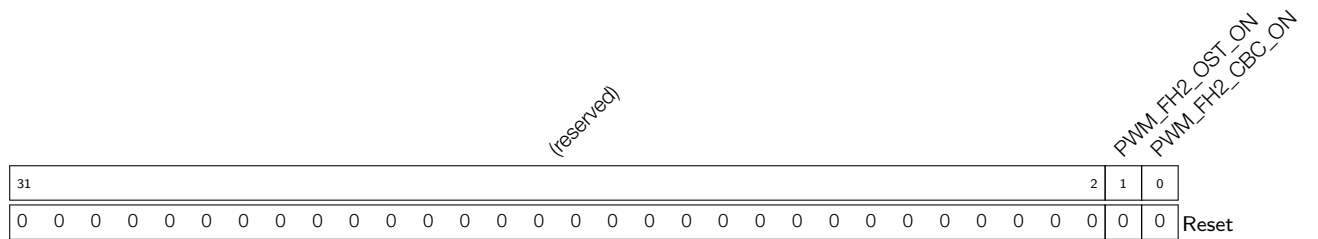
**PWM\_FH2\_FORCE\_OST** A toggle (software negation of this bit's value) triggers a one-shot mode action. (R/W)

**PWM\_FH2\_FORCE\_CBC** A toggle triggers a cycle-by-cycle mode action. (R/W)

**PWM\_FH2\_CBCPULSE** The cycle-by-cycle mode action refresh moment selection. When bit0 is set to 1: TEZ; when bit1 is set to 1:TEP. (R/W)

**PWM\_FH2\_CLR\_OST** A toggle will clear on-going one-shot mode action. (R/W)

**Register 16.57. PWM\_FH2\_STATUS\_REG (0x00e0)**



**PWM\_FH2\_OST\_ON** Set and reset by hardware. If set, a one-shot mode action is on-going. (RO)

**PWM\_FH2\_CBC\_ON** Set and reset by hardware. If set, a cycle-by-cycle mode action is on-going. (RO)

**Register 16.58. PWM\_FAULT\_DETECT\_REG (0x00e4)**

(reserved)																<div style="display: flex; justify-content: space-between;"> <div>PWM_EVENT_F2</div> <div>PWM_EVENT_F1</div> <div>PWM_EVENT_F0</div> <div>PWM_F2_POLE</div> <div>PWM_F1_POLE</div> <div>PWM_F0_POLE</div> <div>PWM_F2_EN</div> <div>PWM_F1_EN</div> <div>PWM_F0_EN</div> </div>																
31																9	8	7	6	5	4	3	2	1	0							
0																0	0	0	0	0	0	0	0	0	0	0	0	0	0	0	0	Reset

- PWM\_EVENT\_F2** Set and reset by hardware. If set, event\_f2 is on-going. (RO)
- PWM\_EVENT\_F1** Set and reset by hardware. If set, event\_f1 is on-going. (RO)
- PWM\_EVENT\_F0** Set and reset by hardware. If set, event\_f0 is on-going. (RO)
- PWM\_F2\_POLE** Set event\_f2 trigger polarity on FAULT2 source from GPIO matrix. 0: level low, 1: level high. (R/W)
- PWM\_F1\_POLE** Set event\_f1 trigger polarity on FAULT2 source from GPIO matrix. 0: level low, 1: level high. (R/W)
- PWM\_F0\_POLE** Set event\_f0 trigger polarity on FAULT2 source from GPIO matrix. 0: level low, 1: level high. (R/W)
- PWM\_F2\_EN** Set to enable the generation of event\_f2. (R/W)
- PWM\_F1\_EN** Set to enable the generation of event\_f1. (R/W)
- PWM\_F0\_EN** Set to enable the generation of event\_f0. (R/W)

**Register 16.59. PWM\_CAP\_TIMER\_CFG\_REG (0x00e8)**

(reserved)																<div style="display: flex; justify-content: space-between;"> <div>PWM_CAP_SYNC_SW</div> <div>PWM_CAP_SYNCI_SEL</div> <div>PWM_CAP_SYNCI_EN</div> <div>PWM_CAP_TIMER_EN</div> </div>									
31																6	5	4			2	1	0		
0																0	0	0	0		0	0	0	0	Reset

- PWM\_CAP\_SYNC\_SW** Set this bit to force a capture timer sync; the capture timer is loaded with the value in the phase register. (WO)
- PWM\_CAP\_SYNCI\_SEL** Capture module sync input selection. 0: none, 1: timer0 sync\_out, 2: timer1 sync\_out, 3: timer2 sync\_out, 4: SYNC0 from GPIO matrix, 5: SYNC1 from GPIO matrix, 6: SYNC2 from GPIO matrix. (R/W)
- PWM\_CAP\_SYNCI\_EN** When set, the capture timer sync is enabled. (R/W)
- PWM\_CAP\_TIMER\_EN** When set, the capture timer incrementing under APB\_clk is enabled. (R/W)

**Register 16.60. PWM\_CAP\_TIMER\_PHASE\_REG (0x00ec)**

31	0	0
		Reset

**PWM\_CAP\_TIMER\_PHASE\_REG** Phase value for the capture timer sync operation. (R/W)

**Register 16.61. PWM\_CAP\_CH0\_CFG\_REG (0x00f0)**

31	13	12	11	10	3	2	1	0
(reserved)				PWM_CAP0_SW PWM_CAP0_IN_INVERT	PWM_CAP0_PRESCALE	PWM_CAP0_MODE PWM_CAP0_EN		
0	0	0	0	0	0	0	0	0
								Reset

**PWM\_CAP0\_SW** When set, a software-forced capture on channel 0 is triggered. (WO)

**PWM\_CAP0\_IN\_INVERT** When set, CAP0 form GPIO matrix is inverted before prescaling. (R/W)

**PWM\_CAP0\_PRESCALE** Prescaling value on the positive edge of CAP0. Prescaling value = PWM\_CAP0\_PRESCALE + 1. (R/W)

**PWM\_CAP0\_MODE** Edge of capture on channel 0 after prescaling. When bit0 is set to 1: enable capture on the negative edge; When bit1 is set to 1: enable capture on the positive edge. (R/W)

**PWM\_CAP0\_EN** When set, capture on channel 0 is enabled. (R/W)

**Register 16.62. PWM\_CAP\_CH1\_CFG\_REG (0x00f4)**

31	13	12	11	10	3	2	1	0
(reserved)				PWM_CAP1_SW PWM_CAP1_IN_INVERT	PWM_CAP1_PRESCALE	PWM_CAP1_MODE PWM_CAP1_EN		
0	0	0	0	0	0	0	0	0
								Reset

**PWM\_CAP1\_SW** Write 1 will trigger a software-forced capture on channel 1. (WO)

**PWM\_CAP1\_IN\_INVERT** When set, CAP1 form GPIO matrix is inverted before prescaling. (R/W)

**PWM\_CAP1\_PRESCALE** Value of prescale on the positive edge of CAP1. Prescale value = PWM\_CAP1\_PRESCALE + 1. (R/W)

**PWM\_CAP1\_MODE** Edge of capture on channel 1 after prescaling. When bit0 is set to 1: enable capture on the negative edge; When bit1 is set to 1: enable capture on the positive edge. (R/W)

**PWM\_CAP1\_EN** When set, capture on channel 1 is enabled. (R/W)

**Register 16.63. PWM\_CAP\_CH2\_CFG\_REG (0x00f8)**

(reserved)													PWM_CAP2_SW PWM_CAP2_IN_INVERT		PWM_CAP2_PRESCALE			PWM_CAP2_MODE PWM_CAP2_EN				
31												13	12	11	10				3	2	1	0
0 0													0	0	0			0	0	0	0	Reset

**PWM\_CAP2\_SW** When set, a software-forced capture on channel 2 is triggered. (WO)

**PWM\_CAP2\_IN\_INVERT** When set, CAP2 form GPIO matrix is inverted before prescaling. (R/W)

**PWM\_CAP2\_PRESCALE** Prescaling value on the positive edge of CAP2. Prescaling value = PWM\_CAP2\_PRESCALE + 1. (R/W)

**PWM\_CAP2\_MODE** Edge of capture on channel 2 after prescaling. When bit0 is set to 1: enable capture on the negative edge; when bit1 is set to 1: enable capture on the positive edge. (R/W)

**PWM\_CAP2\_EN** When set, capture on channel 2 is enabled. (R/W)

**Register 16.64. PWM\_CAP\_CH0\_REG (0x00fc)**

31																															0	
0																																Reset

**PWM\_CAP\_CH0\_REG** Value of the last capture on channel 0. (RO)

**Register 16.65. PWM\_CAP\_CH1\_REG (0x0100)**

31																															0	
0																																Reset

**PWM\_CAP\_CH1\_REG** Value of the last capture on channel 1. (RO)

**Register 16.66. PWM\_CAP\_CH2\_REG (0x0104)**

31																															0	
0																																Reset

**PWM\_CAP\_CH2\_REG** Value of the last capture on channel 2. (RO)



**Register 16.69. INT\_ENA\_PWM\_REG (0x0110)**

(reserved)	INT_CAP2_INT_ENA	INT_CAP1_INT_ENA	INT_CAP0_INT_ENA	INT_FH2_OST_INT_ENA	INT_FH1_OST_INT_ENA	INT_FH0_OST_INT_ENA	INT_FH2_CBC_INT_ENA	INT_FH1_CBC_INT_ENA	INT_FH0_CBC_INT_ENA	INT_OP2_TEB_INT_ENA	INT_OP1_TEB_INT_ENA	INT_OP0_TEB_INT_ENA	INT_OP2_TEA_INT_ENA	INT_OP1_TEA_INT_ENA	INT_OP0_TEA_INT_ENA	INT_FAULT2_CLR_INT_ENA	INT_FAULT1_CLR_INT_ENA	INT_FAULT0_CLR_INT_ENA	INT_FAULT2_INT_ENA	INT_FAULT1_INT_ENA	INT_FAULT0_INT_ENA	INT_TIMER2_TEP_INT_ENA	INT_TIMER1_TEP_INT_ENA	INT_TIMER2_TEZ_INT_ENA	INT_TIMER1_TEZ_INT_ENA	INT_TIMER0_TEZ_INT_ENA	INT_TIMER2_STOP_INT_ENA	INT_TIMER1_STOP_INT_ENA	INT_TIMER0_STOP_INT_ENA		
31	30	29	28	27	26	25	24	23	22	21	20	19	18	17	16	15	14	13	12	11	10	9	8	7	6	5	4	3	2	1	0
0	0	0	0	0	0	0	0	0	0	0	0	0	0	0	0	0	0	0	0	0	0	0	0	0	0	0	0	0	0	0	Reset

- INT\_CAP2\_INT\_ENA** The enable bit for the interrupt triggered by capture on channel 2. (R/W)
- INT\_CAP1\_INT\_ENA** The enable bit for the interrupt triggered by capture on channel 1. (R/W)
- INT\_CAP0\_INT\_ENA** The enable bit for the interrupt triggered by capture on channel 0. (R/W)
- INT\_FH2\_OST\_INT\_ENA** The enable bit for the interrupt triggered by a one-shot mode action on PWM2. (R/W)
- INT\_FH1\_OST\_INT\_ENA** The enable bit for the interrupt triggered by a one-shot mode action on PWM1. (R/W)
- INT\_FH0\_OST\_INT\_ENA** The enable bit for the interrupt triggered by a one-shot mode action on PWM0. (R/W)
- INT\_FH2\_CBC\_INT\_ENA** The enable bit for the interrupt triggered by a cycle-by-cycle mode action on PWM2. (R/W)
- INT\_FH1\_CBC\_INT\_ENA** The enable bit for the interrupt triggered by a cycle-by-cycle mode action on PWM1. (R/W)
- INT\_FH0\_CBC\_INT\_ENA** The enable bit for the interrupt triggered by a cycle-by-cycle mode action on PWM0. (R/W)
- INT\_OP2\_TEB\_INT\_ENA** The enable bit for the interrupt triggered by a PWM operator 2 TEB event (R/W)
- INT\_OP1\_TEB\_INT\_ENA** The enable bit for the interrupt triggered by a PWM operator 1 TEB event (R/W)
- INT\_OP0\_TEB\_INT\_ENA** The enable bit for the interrupt triggered by a PWM operator 0 TEB event (R/W)
- INT\_OP2\_TEA\_INT\_ENA** The enable bit for the interrupt triggered by a PWM operator 2 TEA event (R/W)
- INT\_OP1\_TEA\_INT\_ENA** The enable bit for the interrupt triggered by a PWM operator 1 TEA event (R/W)
- INT\_OP0\_TEA\_INT\_ENA** The enable bit for the interrupt triggered by a PWM operator 0 TEA event (R/W)
- INT\_FAULT2\_CLR\_INT\_ENA** The enable bit for the interrupt triggered when event\_f2 ends. (R/W)
- INT\_FAULT1\_CLR\_INT\_ENA** The enable bit for the interrupt triggered when event\_f1 ends. (R/W)
- INT\_FAULT0\_CLR\_INT\_ENA** The enable bit for the interrupt triggered when event\_f0 ends. (R/W)
- INT\_FAULT2\_INT\_ENA** The enable bit for the interrupt triggered when event\_f2 starts. (R/W)
- INT\_FAULT1\_INT\_ENA** The enable bit for the interrupt triggered when event\_f1 starts. (R/W)
- INT\_FAULT0\_INT\_ENA** The enable bit for the interrupt triggered when event\_f0 starts. (R/W)
- INT\_TIMER2\_TEP\_INT\_ENA** The enable bit for the interrupt triggered by a PWM timer 2 TEP event. (R/W)
- INT\_TIMER1\_TEP\_INT\_ENA** The enable bit for the interrupt triggered by a PWM timer 1 TEP event. (R/W)

Continued on the next page...

**Register 16.69. INT\_ENA\_PWM\_REG (0x0110)**

Continued from the previous page...

**INT\_TIMER0\_TEP\_INT\_ENA** The enable bit for the interrupt triggered by a PWM timer 0 TEP event.  
(R/W)

**INT\_TIMER2\_TEZ\_INT\_ENA** The enable bit for the interrupt triggered by a PWM timer 2 TEZ event.  
(R/W)

**INT\_TIMER1\_TEZ\_INT\_ENA** The enable bit for the interrupt triggered by a PWM timer 1 TEZ event.  
(R/W)

**INT\_TIMER0\_TEZ\_INT\_ENA** The enable bit for the interrupt triggered by a PWM timer 0 TEZ event.  
(R/W)

**INT\_TIMER2\_STOP\_INT\_ENA** The enable bit for the interrupt triggered when the timer 2 stops. (R/W)

**INT\_TIMER1\_STOP\_INT\_ENA** The enable bit for the interrupt triggered when the timer 1 stops. (R/W)

**INT\_TIMER0\_STOP\_INT\_ENA** The enable bit for the interrupt triggered when the timer 0 stops. (R/W)

**Register 16.70. INT\_RAW\_PWM\_REG (0x0114)**

(reserved)	INT_CAP2_INT_RAW	INT_CAP1_INT_RAW	INT_CAP0_INT_RAW	INT_FH2_OST_INT_RAW	INT_FH1_OST_INT_RAW	INT_FH0_OST_INT_RAW	INT_FH2_CBC_INT_RAW	INT_FH1_CBC_INT_RAW	INT_FH0_CBC_INT_RAW	INT_OP2_TEB_INT_RAW	INT_OP1_TEB_INT_RAW	INT_OP0_TEB_INT_RAW	INT_OP2_TEA_INT_RAW	INT_OP1_TEA_INT_RAW	INT_OP0_TEA_INT_RAW	INT_FAULT2_CLR_INT_RAW	INT_FAULT1_CLR_INT_RAW	INT_FAULT0_CLR_INT_RAW	INT_FAULT2_INT_RAW	INT_FAULT1_INT_RAW	INT_FAULT0_INT_RAW	INT_TIMER2_TEP_INT_RAW	INT_TIMER1_TEP_INT_RAW	INT_TIMER0_TEP_INT_RAW	INT_TIMER2_TEZ_INT_RAW	INT_TIMER1_TEZ_INT_RAW	INT_TIMER0_TEZ_INT_RAW	INT_TIMER2_STOP_INT_RAW	INT_TIMER1_STOP_INT_RAW	INT_TIMER0_STOP_INT_RAW		
31	30	29	28	27	26	25	24	23	22	21	20	19	18	17	16	15	14	13	12	11	10	9	8	7	6	5	4	3	2	1	0	
0	0	0	0	0	0	0	0	0	0	0	0	0	0	0	0	0	0	0	0	0	0	0	0	0	0	0	0	0	0	0	0	Reset

- INT\_CAP2\_INT\_RAW** The raw status bit for the interrupt triggered by capture on channel 2. (RO)
- INT\_CAP1\_INT\_RAW** The raw status bit for the interrupt triggered by capture on channel 1. (RO)
- INT\_CAP0\_INT\_RAW** The raw status bit for the interrupt triggered by capture on channel 0. (RO)
- INT\_FH2\_OST\_INT\_RAW** The raw status bit for the interrupt triggered by a one-shot mode action on PWM2. (RO)
- INT\_FH1\_OST\_INT\_RAW** The raw status bit for the interrupt triggered by a one-shot mode action on PWM0. (RO)
- INT\_FH0\_OST\_INT\_RAW** The raw status bit for the interrupt triggered by a one-shot mode action on PWM0. (RO)
- INT\_FH2\_CBC\_INT\_RAW** The raw status bit for the interrupt triggered by a cycle-by-cycle mode action on PWM2. (RO)
- INT\_FH1\_CBC\_INT\_RAW** The raw status bit for the interrupt triggered by a cycle-by-cycle mode action on PWM1. (RO)
- INT\_FH0\_CBC\_INT\_RAW** The raw status bit for the interrupt triggered by a cycle-by-cycle mode action on PWM0. (RO)
- INT\_OP2\_TEB\_INT\_RAW** The raw status bit for the interrupt triggered by a PWM operator 2 TEB event. (RO)
- INT\_OP1\_TEB\_INT\_RAW** The raw status bit for the interrupt triggered by a PWM operator 1 TEB event. (RO)
- INT\_OP0\_TEB\_INT\_RAW** The raw status bit for the interrupt triggered by a PWM operator 0 TEB event. (RO)
- INT\_OP2\_TEA\_INT\_RAW** The raw status bit for the interrupt triggered by a PWM operator 2 TEA event. (RO)
- INT\_OP1\_TEA\_INT\_RAW** The raw status bit for the interrupt triggered by a PWM operator 1 TEA event. (RO)
- INT\_OP0\_TEA\_INT\_RAW** The raw status bit for the interrupt triggered by a PWM operator 0 TEA event. (RO)
- INT\_FAULT2\_CLR\_INT\_RAW** The raw status bit for the interrupt triggered when event\_f2 ends. (RO)
- INT\_FAULT1\_CLR\_INT\_RAW** The raw status bit for the interrupt triggered when event\_f1 ends. (RO)
- INT\_FAULT0\_CLR\_INT\_RAW** The raw status bit for the interrupt triggered when event\_f0 ends. (RO)
- INT\_FAULT2\_INT\_RAW** The raw status bit for the interrupt triggered when event\_f2 starts. (RO)
- INT\_FAULT1\_INT\_RAW** The raw status bit for the interrupt triggered when event\_f1 starts. (RO)
- INT\_FAULT0\_INT\_RAW** The raw status bit for the interrupt triggered when event\_f0 starts. (RO)
- INT\_TIMER2\_TEP\_INT\_RAW** The raw status bit for the interrupt triggered by a PWM timer 2 TEP event. (RO)
- INT\_TIMER1\_TEP\_INT\_RAW** The raw status bit for the interrupt triggered by a PWM timer 1 TEP event. (RO)

Continued on the next page...



**Register 16.70. INT\_RAW\_PWM\_REG (0x0114)**

Continued from the previous page...

**INT\_TIMER0\_TEP\_INT\_RAW** The raw status bit for the interrupt triggered by a PWM timer 0 TEP event. (RO)

**INT\_TIMER2\_TEZ\_INT\_RAW** The raw status bit for the interrupt triggered by a PWM timer 2 TEZ event. (RO)

**INT\_TIMER1\_TEZ\_INT\_RAW** The raw status bit for the interrupt triggered by a PWM timer 1 TEZ event. (RO)

**INT\_TIMER0\_TEZ\_INT\_RAW** The raw status bit for the interrupt triggered by a PWM timer 0 TEZ event. (RO)

**INT\_TIMER2\_STOP\_INT\_RAW** The raw status bit for the interrupt triggered when the timer 2 stops. (RO)

**INT\_TIMER1\_STOP\_INT\_RAW** The raw status bit for the interrupt triggered when the timer 1 stops. (RO)

**INT\_TIMER0\_STOP\_INT\_RAW** The raw status bit for the interrupt triggered when the timer 0 stops. (RO)

## Register 16.71. INT\_ST\_PWM\_REG (0x0118)

(reserved)	INT_CAP2_INT_ST	INT_CAP1_INT_ST	INT_CAP0_INT_ST	INT_FH2_OST_INT_ST	INT_FH1_OST_INT_ST	INT_FH0_OST_INT_ST	INT_FH2_CBC_INT_ST	INT_FH1_CBC_INT_ST	INT_FH0_CBC_INT_ST	INT_OP2_TEB_INT_ST	INT_OP1_TEB_INT_ST	INT_OP0_TEB_INT_ST	INT_OP2_TEA_INT_ST	INT_OP1_TEA_INT_ST	INT_OP0_TEA_INT_ST	INT_FAULT2_CLR_INT_ST	INT_FAULT1_CLR_INT_ST	INT_FAULT0_CLR_INT_ST	INT_FAULT2_INT_ST	INT_FAULT1_INT_ST	INT_FAULT0_INT_ST	INT_TIMER2_INT_ST	INT_TIMER1_INT_ST	INT_TIMER0_INT_ST	INT_TIMER2_TEP_INT_ST	INT_TIMER1_TEP_INT_ST	INT_TIMER0_TEP_INT_ST	INT_TIMER2_TEZ_INT_ST	INT_TIMER1_TEZ_INT_ST	INT_TIMER0_TEZ_INT_ST	INT_TIMER2_STOP_INT_ST	INT_TIMER1_STOP_INT_ST	INT_TIMER0_STOP_INT_ST	Reset
31	30	29	28	27	26	25	24	23	22	21	20	19	18	17	16	15	14	13	12	11	10	9	8	7	6	5	4	3	2	1	0	0		
0	0	0	0	0	0	0	0	0	0	0	0	0	0	0	0	0	0	0	0	0	0	0	0	0	0	0	0	0	0	0	0	0	0	

**INT\_CAP2\_INT\_ST** The masked status bit for the interrupt triggered by capture on channel 2. (RO)

**INT\_CAP1\_INT\_ST** The masked status bit for the interrupt triggered by capture on channel 1. (RO)

**INT\_CAP0\_INT\_ST** The masked status bit for the interrupt triggered by capture on channel 0. (RO)

**INT\_FH2\_OST\_INT\_ST** The masked status bit for the interrupt triggered by a one-shot mode action on PWM2. (RO)

**INT\_FH1\_OST\_INT\_ST** The masked status bit for the interrupt triggered by a one-shot mode action on PWM1. (RO)

**INT\_FH0\_OST\_INT\_ST** The masked status bit for the interrupt triggered by a one-shot mode action on PWM0. (RO)

**INT\_FH2\_CBC\_INT\_ST** The masked status bit for the interrupt triggered by a cycle-by-cycle mode action on PWM2. (RO)

**INT\_FH1\_CBC\_INT\_ST** The masked status bit for the interrupt triggered by a cycle-by-cycle mode action on PWM1. (RO)

**INT\_FH0\_CBC\_INT\_ST** The masked status bit for the interrupt triggered by a cycle-by-cycle mode action on PWM0. (RO)

**INT\_OP2\_TEB\_INT\_ST** The masked status bit for the interrupt triggered by a PWM operator 2 TEB event. (RO)

**INT\_OP1\_TEB\_INT\_ST** The masked status bit for the interrupt triggered by a PWM operator 1 TEB event. (RO)

**INT\_OP0\_TEB\_INT\_ST** The masked status bit for the interrupt triggered by a PWM operator 0 TEB event. (RO)

**INT\_OP2\_TEA\_INT\_ST** The masked status bit for the interrupt triggered by a PWM operator 2 TEA event. (RO)

**INT\_OP1\_TEA\_INT\_ST** The masked status bit for the interrupt triggered by a PWM operator 1 TEA event. (RO)

**INT\_OP0\_TEA\_INT\_ST** The masked status bit for the interrupt triggered by a PWM operator 0 TEA event. (RO)

**INT\_FAULT2\_CLR\_INT\_ST** The masked status bit for the interrupt triggered when event\_f2 ends. (RO)

**INT\_FAULT1\_CLR\_INT\_ST** The masked status bit for the interrupt triggered when event\_f1 ends. (RO)

**INT\_FAULT0\_CLR\_INT\_ST** The masked status bit for the interrupt triggered when event\_f0 ends. (RO)

**INT\_FAULT2\_INT\_ST** The masked status bit for the interrupt triggered when event\_f2 starts. (RO)

Continued on the next page...

**Register 16.71. INT\_ST\_PWM\_REG (0x0118)**

Continued from the previous page...

**INT\_FAULT1\_INT\_ST** The masked status bit for the interrupt triggered when event\_f1 starts. (RO)

**INT\_FAULT0\_INT\_ST** The masked status bit for the interrupt triggered when event\_f0 starts. (RO)

**INT\_TIMER2\_TEP\_INT\_ST** The masked status bit for the interrupt triggered by a PWM timer 2 TEP event. (RO)

**INT\_TIMER1\_TEP\_INT\_ST** The masked status bit for the interrupt triggered by a PWM timer 1 TEP event. (RO)

**INT\_TIMER0\_TEP\_INT\_ST** The masked status bit for the interrupt triggered by a PWM timer 0 TEP event. (RO)

**INT\_TIMER2\_TEZ\_INT\_ST** The masked status bit for the interrupt triggered by a PWM timer 2 TEZ event. (RO)

**INT\_TIMER1\_TEZ\_INT\_ST** The masked status bit for the interrupt triggered by a PWM timer 1 TEZ event. (RO)

**INT\_TIMER0\_TEZ\_INT\_ST** The masked status bit for the interrupt triggered by a PWM timer 0 TEZ event. (RO)

**INT\_TIMER2\_STOP\_INT\_ST** The masked status bit for the interrupt triggered when the timer 2 stops. (RO)

**INT\_TIMER1\_STOP\_INT\_ST** The masked status bit for the interrupt triggered when the timer 1 stops. (RO)

**INT\_TIMER0\_STOP\_INT\_ST** The masked status bit for the interrupt triggered when the timer 0 stops. (RO)

**Register 16.72. INT\_CLR\_PWM\_REG (0x011c)**

(reserved)	INT_CAP2_INT_CLR	INT_CAP1_INT_CLR	INT_CAP0_INT_CLR	INT_FH2_OST_INT_CLR	INT_FH1_OST_INT_CLR	INT_FH0_OST_INT_CLR	INT_FH2_CBC_INT_CLR	INT_FH1_CBC_INT_CLR	INT_FH0_CBC_INT_CLR	INT_OP2_TEB_INT_CLR	INT_OP1_TEB_INT_CLR	INT_OP0_TEB_INT_CLR	INT_OP2_TEA_INT_CLR	INT_OP1_TEA_INT_CLR	INT_OP0_TEA_INT_CLR	INT_FAULT2_CLR_INT_CLR	INT_FAULT1_CLR_INT_CLR	INT_FAULT0_CLR_INT_CLR	INT_FAULT2_INT_CLR	INT_FAULT1_INT_CLR	INT_FAULT0_INT_CLR	INT_TIMER2_TEP_INT_CLR	INT_TIMER1_TEP_INT_CLR	INT_TIMER0_TEP_INT_CLR	INT_TIMER2_TEZ_INT_CLR	INT_TIMER1_TEZ_INT_CLR	INT_TIMER0_TEZ_INT_CLR	INT_TIMER2_STOP_INT_CLR	INT_TIMER1_STOP_INT_CLR	INT_TIMER0_STOP_INT_CLR	
31	30	29	28	27	26	25	24	23	22	21	20	19	18	17	16	15	14	13	12	11	10	9	8	7	6	5	4	3	2	1	0
0	0	0	0	0	0	0	0	0	0	0	0	0	0	0	0	0	0	0	0	0	0	0	0	0	0	0	0	0	0	0	0

Reset

- INT\_CAP2\_INT\_CLR** Set this bit to clear interrupt triggered by capture on channel 2. (WO)
- INT\_CAP1\_INT\_CLR** Set this bit to clear interrupt triggered by capture on channel 1. (WO)
- INT\_CAP0\_INT\_CLR** Set this bit to clear interrupt triggered by capture on channel 0. (WO)
- INT\_FH2\_OST\_INT\_CLR** Set this bit to clear interrupt triggered by a one-shot mode action on PWM2. (WO)
- INT\_FH1\_OST\_INT\_CLR** Set this bit to clear interrupt triggered by a one-shot mode action on PWM1. (WO)
- INT\_FH0\_OST\_INT\_CLR** Set this bit to clear interrupt triggered by a one-shot mode action on PWM0. (WO)
- INT\_FH2\_CBC\_INT\_CLR** Set this bit to clear interrupt triggered by a cycle-by-cycle mode action on PWM2. (WO)
- INT\_FH1\_CBC\_INT\_CLR** Set this bit to clear interrupt triggered by a cycle-by-cycle mode action on PWM1. (WO)
- INT\_FH0\_CBC\_INT\_CLR** Set this bit to clear interrupt triggered by a cycle-by-cycle mode action on PWM0. (WO)
- INT\_OP2\_TEB\_INT\_CLR** Set this bit to clear interrupt triggered by a PWM operator 2 TEB event. (WO)
- INT\_OP1\_TEB\_INT\_CLR** Set this bit to clear interrupt triggered by a PWM operator 1 TEB event. (WO)
- INT\_OP0\_TEB\_INT\_CLR** Set this bit to clear interrupt triggered by a PWM operator 0 TEB event. (WO)
- INT\_OP2\_TEA\_INT\_CLR** Set this bit to clear interrupt triggered by a PWM operator 2 TEA event. (WO)
- INT\_OP1\_TEA\_INT\_CLR** Set this bit to clear interrupt triggered by a PWM operator 1 TEA event. (WO)
- INT\_OP0\_TEA\_INT\_CLR** Set this bit to clear interrupt triggered by a PWM operator 0 TEA event. (WO)
- INT\_FAULT2\_CLR\_INT\_CLR** Set this bit to clear interrupt triggered when event\_f2 ends. (WO)
- INT\_FAULT1\_CLR\_INT\_CLR** Set this bit to clear interrupt triggered when event\_f1 ends. (WO)
- INT\_FAULT0\_CLR\_INT\_CLR** Set this bit to clear interrupt triggered when event\_f0 ends. (WO)
- INT\_FAULT2\_INT\_CLR** Set this bit to clear interrupt triggered when event\_f2 starts. (WO)
- INT\_FAULT1\_INT\_CLR** Set this bit to clear interrupt triggered when event\_f1 starts. (WO)
- INT\_FAULT0\_INT\_CLR** Set this bit to clear interrupt triggered when event\_f0 starts. (WO)
- INT\_TIMER2\_TEP\_INT\_CLR** Set this bit to clear interrupt triggered by a PWM timer 2 TEP event. (WO)

Continued on the next page...

**Register 16.72. INT\_CLR\_PWM\_REG (0x011c)**

Continued from the previous page...

**INT\_TIMER1\_TEP\_INT\_CLR** Set this bit to clear interrupt triggered by a PWM timer 1 TEP event.  
(WO)

**INT\_TIMER0\_TEP\_INT\_CLR** Set this bit to clear interrupt triggered by a PWM timer 0 TEP event.  
(WO)

**INT\_TIMER2\_TEZ\_INT\_CLR** Set this bit to clear interrupt triggered by a PWM timer 2 TEZ event.  
(WO)

**INT\_TIMER1\_TEZ\_INT\_CLR** Set this bit to clear interrupt triggered by a PWM timer 1 TEZ event.  
(WO)

**INT\_TIMER0\_TEZ\_INT\_CLR** Set this bit to clear interrupt triggered by a PWM timer 0 TEZ event.  
(WO)

**INT\_TIMER2\_STOP\_INT\_CLR** Set this bit to clear interrupt triggered when the timer 2 stops. (WO)

**INT\_TIMER1\_STOP\_INT\_CLR** Set this bit to clear interrupt triggered when the timer 1 stops. (WO)

**INT\_TIMER0\_STOP\_INT\_CLR** Set this bit to clear interrupt triggered when the timer 0 stops. (WO)

## 17 Pulse Count Controller (PCNT)

### 17.1 Overview

The pulse counter module is designed to count the number of rising and/or falling edges of an input signal. Each pulse counter unit has a 16-bit signed counter register and two channels that can be configured to either increment or decrement the counter. Each channel has a signal input that accepts signal edges to be detected, as well as a control input that can be used to enable or disable the signal input. The inputs have optional filters that can be used to discard unwanted glitches in the signal.

The pulse counter has eight independent units, referred to as PULSE\_CNT\_Un.

The maximum frequency of pulses supported by ESP32's pulse counter is 40 MHz.

### 17.2 Functional Description

#### 17.2.1 Architecture

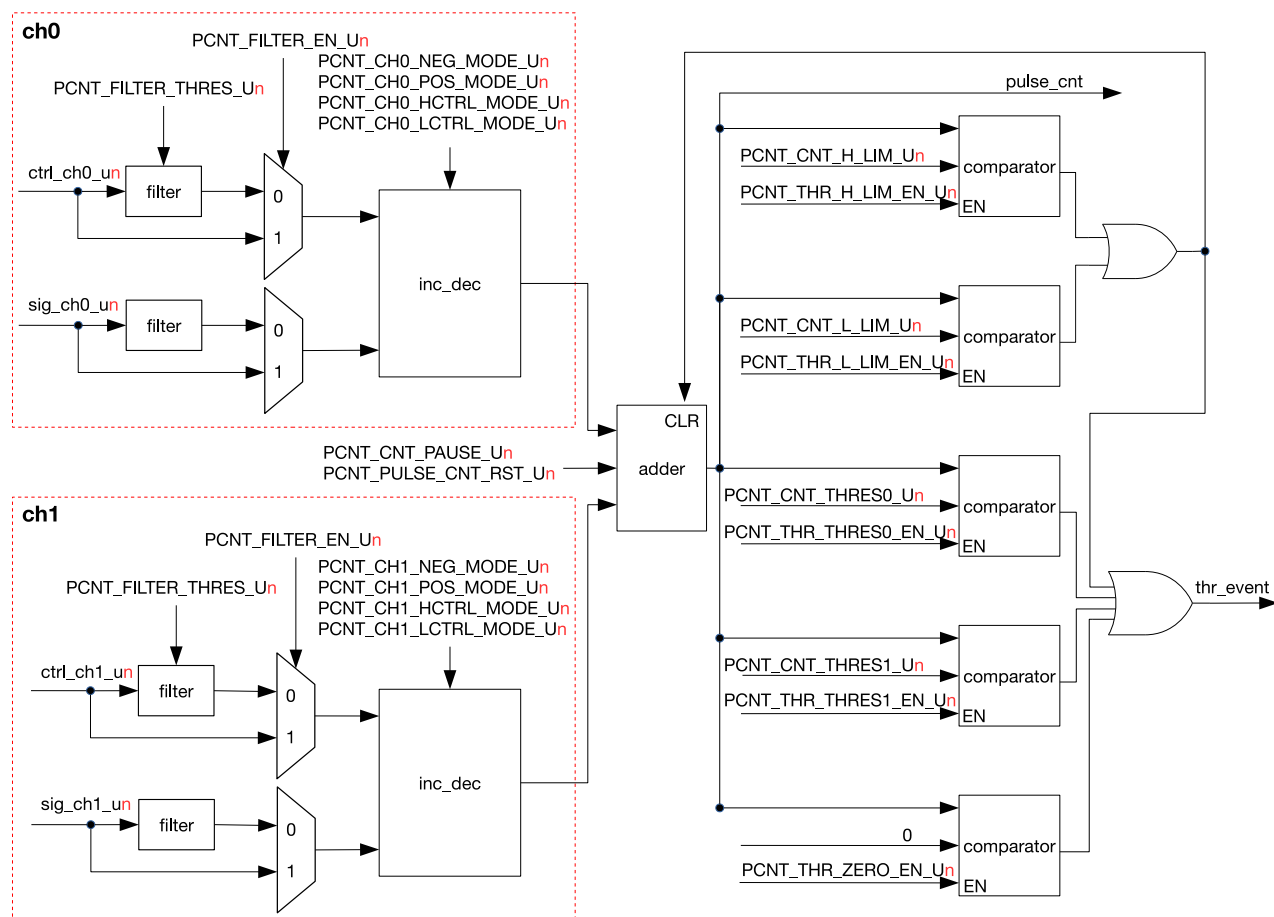


Figure 17-1. PULSE\_CNT Architecture

The architecture of a pulse counter unit is illustrated in Figure 17-1. Each unit has two channels: ch0 and ch1, which are functionally equivalent. Each channel has a signal input, as well as a control input, which can both be connected to I/O pads. The counting behavior on both the positive and negative edge can be configured separately to increase, decrease, or do nothing to the counter value. Separately, for both control signal levels, the hardware can be configured to modify the edge action: invert it, disable it, or do nothing. The counter itself is a 16-bit signed

up/down counter. Its value can be read by software directly, but is also monitored by a set of comparators which can trigger an interrupt.

### 17.2.2 Counter Channel Inputs

As stated before, the two inputs of a channel can affect the pulse counter in various ways. The specifics of this behaviour are set by LCTRL\_MODE and HCTRL\_MODE in this case when the control signal is low or high, respectively, and POS\_MODE and NEG\_MODE for positive and negative edges of the input signal. Setting POS\_MODE and NEG\_MODE to 1 will increase the counter when an edge is detected, setting them to 2 will decrease the counter and setting at any other value will neutralize the effect of the edge on the counter. LCTR\_MODE and HCTR\_MODE modify this behaviour, when the control input has the corresponding low or high value: 0 does not modify the NEG\_MODE and POS\_MODE behaviour, 1 inverts it (setting POS\_MODE/NEG\_MODE to increase the counter should now decrease the counter and vice versa) and any other value disables counter effects for that signal level.

To summarize, a few examples have been considered. In this table, the effect on the counter for a rising edge is shown for both a low and a high control signal, as well as various other configuration options. For clarity, a short description in brackets is added after the values. Note: x denotes 'do not care'.

POS_MODE	LCTRL_MODE	HCTRL_MODE	sig l→h when ctrl=0	sig l→h when ctrl=1
1 (inc)	0 (-)	0 (-)	Inc ctr	Inc ctr
2 (dec)	0 (-)	0 (-)	Dec ctr	Dec ctr
0 (-)	x	x	No action	No action
1 (inc)	0 (-)	1 (inv)	Inc ctr	Dec ctr
1 (inc)	1 (inv)	0 (-)	Dec ctr	Inc ctr
2 (dec)	0 (-)	1 (inv)	Dec ctr	Inc ctr
1 (inc)	0 (-)	2 (dis)	Inc ctr	No action
1 (inc)	2 (dis)	0 (-)	No action	Inc ctr

This table is also valid for negative edges (sig h→l) on substituting NEG\_MODE for POS\_MODE.

Each pulse counter unit also features a filter on each of the four inputs, adding the option to ignore short glitches in the signals. If a PCNT\_FILTER\_EN\_Un can be set to filter the four input signals of the unit. If this filter is enabled, any pulses shorter than REG\_FILTER\_THRES\_Un number of APB\_CLK clock cycles will be filtered out and will have no effect on the counter. With the filter disabled, in theory infinitely small glitches could possibly trigger pulse counter action. However, in practice the signal inputs are sampled on APB\_CLK edges and even with the filter disabled, pulse widths lasting shorter than one APB\_CLK cycle may be missed.

Apart from the input channels, software also has some control over the counter. In particular, the counter value can be frozen to the current value by configuring PCNT\_CNT\_PAUSE\_Un. It can also be reset to 0 by configuring PCNT\_PLUS\_CNT\_RST\_Un.

### 17.2.3 Watchpoints

The pulse counters have five watchpoints that share one interrupt. Interrupt generation can be enabled or disabled for each individual watchpoint. The watchpoints are:

- Maximum count value: Triggered when PULSE\_CNT >= PCNT\_CNT\_H\_LIM\_Un. Additionally, this will reset the counter to 0. PCNT\_CNT\_H\_LIM\_Un should be a positive number.
- Minimum count value: Triggered when PULSE\_CNT <= PCNT\_CNT\_L\_LIM\_Un. Additionally, this will reset

the counter to 0.  $PCNT\_CNT\_L\_LIM\_Un$  should be a negative number.

- Two threshold values: Triggered when  $PULSE\_CNT = PCNT\_THR\_THRES0\_Un$  or  $PCNT\_THR\_THRES1\_Un$ .
- Zero: Triggered when  $PULSE\_CNT = 0$ .

### 17.2.4 Examples

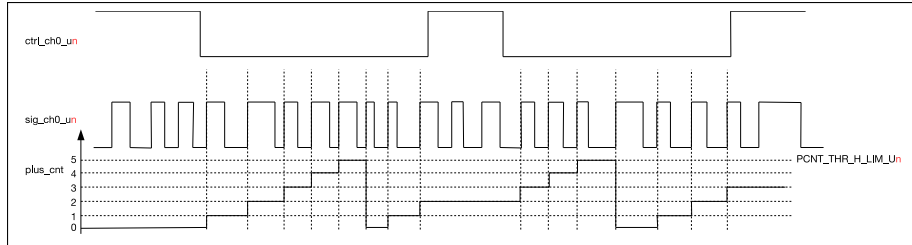


Figure 17-2. PULSE\_CNT Upcounting Diagram

Figure 17-2 shows channel 0 being used as an up-counter. The configuration of channel 0 is shown below.

- $CNT\_CH0\_POS\_MODE\_Un = 1$ : increase counter on the rising edge of  $sig\_ch0\_un$ .
- $PCNT\_CH0\_NEG\_MODE\_Un = 0$ : no counting on the falling edge of  $sig\_ch0\_un$ .
- $PCNT\_CH0\_LCTRL\_MODE\_Un = 0$ : Do not modify counter mode when  $ctrl\_ch0\_un$  is low.
- $PCNT\_CH0\_HCTRL\_MODE\_Un = 2$ : Do not allow counter increments/decrements when  $ctrl\_ch0\_un$  is high.
- $PCNT\_CNT\_H\_LIM\_Un = 5$ : PULSE\_CNT resets to 0 when the count value increases to 5.

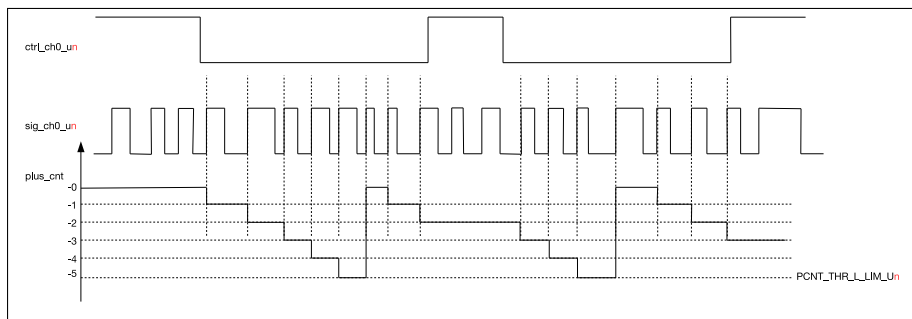


Figure 17-3. PULSE\_CNT Downcounting Diagram

Figure 17-3 shows channel 0 decrementing the counter. The configuration of channel 0 differs from that in Figure 17-2 in the following two aspects:

- $PCNT\_CH0\_LCTRL\_MODE\_Un = 1$ : invert counter mode when  $ctrl\_ch0\_un$  is at low level, so it will decrease, rather than increase, the counter.
- $PCNT\_CNT\_H\_LIM\_Un = -5$ : PULSE\_CNT resets to 0 when the count value decreases to  $-5$ .

### 17.2.5 Interrupts

$PCNT\_CNT\_THR\_EVENT\_Un\_INT$ : This interrupt gets triggered when one of the five channel comparators detects a match.



## 17.3 Register Summary

Name	Description	Address	Access
<b>Configuration registers</b>			
PCNT_U0_CONF0_REG	Configuration register 0 for unit 0	0x3FF57000	R/W
PCNT_U1_CONF0_REG	Configuration register 0 for unit 1	0x3FF5700C	R/W
PCNT_U2_CONF0_REG	Configuration register 0 for unit 2	0x3FF57018	R/W
PCNT_U3_CONF0_REG	Configuration register 0 for unit 3	0x3FF57024	R/W
PCNT_U4_CONF0_REG	Configuration register 0 for unit 4	0x3FF57030	R/W
PCNT_U5_CONF0_REG	Configuration register 0 for unit 5	0x3FF5703C	R/W
PCNT_U6_CONF0_REG	Configuration register 0 for unit 6	0x3FF57048	R/W
PCNT_U7_CONF0_REG	Configuration register 0 for unit 7	0x3FF57054	R/W
PCNT_U0_CONF1_REG	Configuration register 1 for unit 0	0x3FF57004	R/W
PCNT_U1_CONF1_REG	Configuration register 1 for unit 1	0x3FF57010	R/W
PCNT_U2_CONF1_REG	Configuration register 1 for unit 2	0x3FF5701C	R/W
PCNT_U3_CONF1_REG	Configuration register 1 for unit 3	0x3FF57028	R/W
PCNT_U4_CONF1_REG	Configuration register 1 for unit 4	0x3FF57034	R/W
PCNT_U5_CONF1_REG	Configuration register 1 for unit 5	0x3FF57040	R/W
PCNT_U6_CONF1_REG	Configuration register 1 for unit 6	0x3FF5704C	R/W
PCNT_U7_CONF1_REG	Configuration register 1 for unit 7	0x3FF57058	R/W
PCNT_U0_CONF2_REG	Configuration register 2 for unit 0	0x3FF57008	R/W
PCNT_U1_CONF2_REG	Configuration register 2 for unit 1	0x3FF57014	R/W
PCNT_U2_CONF2_REG	Configuration register 2 for unit 2	0x3FF57020	R/W
PCNT_U3_CONF2_REG	Configuration register 2 for unit 3	0x3FF5702C	R/W
PCNT_U4_CONF2_REG	Configuration register 2 for unit 4	0x3FF57038	R/W
PCNT_U5_CONF2_REG	Configuration register 2 for unit 5	0x3FF57044	R/W
PCNT_U6_CONF2_REG	Configuration register 2 for unit 6	0x3FF57050	R/W
PCNT_U7_CONF2_REG	Configuration register 2 for unit 7	0x3FF5705C	R/W
<b>Counter values</b>			
PCNT_U0_CNT_REG	Counter value for unit 0	0x3FF57060	RO
PCNT_U1_CNT_REG	Counter value for unit 1	0x3FF57064	RO
PCNT_U2_CNT_REG	Counter value for unit 2	0x3FF57068	RO
PCNT_U3_CNT_REG	Counter value for unit 3	0x3FF5706C	RO
PCNT_U4_CNT_REG	Counter value for unit 4	0x3FF57070	RO
PCNT_U5_CNT_REG	Counter value for unit 5	0x3FF57074	RO
PCNT_U6_CNT_REG	Counter value for unit 6	0x3FF57078	RO
PCNT_U7_CNT_REG	Counter value for unit 7	0x3FF5707C	RO
<b>Control registers</b>			
PCNT_CTRL_REG	Control register for all counters	0x3FF570B0	R/W
<b>Interrupt registers</b>			
PCNT_INT_RAW_REG	Raw interrupt status	0x3FF57080	RO
PCNT_INT_ST_REG	Masked interrupt status	0x3FF57084	RO
PCNT_INT_ENA_REG	Interrupt enable bits	0x3FF57088	R/W
PCNT_INT_CLR_REG	Interrupt clear bits	0x3FF5708C	WO
<b>Status registers</b>			
PCNT_Un_STATUS_REG	Indicate the status of counter	0x3FF57090	RO

## 17.4 Registers

**Register 17.1. PCNT\_U<sub>n</sub>\_CONF0\_REG (n: 0-7) (0x0+0x0C\*n)**

PCNT_CH1_LCTRL_MODE_U <sub>n</sub>										PCNT_CH1_HCTRL_MODE_U <sub>n</sub>										PCNT_CH1_POS_MODE_U <sub>n</sub>										PCNT_CH1_NEG_MODE_U <sub>n</sub>										PCNT_CH0_LCTRL_MODE_U <sub>n</sub>										PCNT_CH0_HCTRL_MODE_U <sub>n</sub>										PCNT_CH0_POS_MODE_U <sub>n</sub>										PCNT_CH0_NEG_MODE_U <sub>n</sub>										PCNT_THR_THRES1_EN_U <sub>n</sub>										PCNT_THR_THRES0_EN_U <sub>n</sub>										PCNT_THR_H_LIM_EN_U <sub>n</sub>										PCNT_THR_H_LIM_EN_U <sub>n</sub>										PCNT_THR_ZERO_EN_U <sub>n</sub>										PCNT_FILTER_EN_U <sub>n</sub>										PCNT_FILTER_THRES_U <sub>n</sub>										0	Reset
31	30	29	28	27	26	25	24	23	22	21	20	19	18	17	16	15	14	13	12	11	10	9											0																																																																																																																						
0	0	0	0	0	0	0	0	0	0	0	0	0	0	0	0	0	0	1	1	1	1	0x010										0																																																																																																																							

**PCNT\_CH1\_LCTRL\_MODE\_U<sub>n</sub>** This register configures how the CH1\_POS\_MODE/CH1\_NEG\_MODE settings will be modified when the control signal is low. (R/W) 0: No modification; 1: Invert behaviour (increase -> decrease, decrease -> increase); 2, 3: Inhibit counter modification

**PCNT\_CH1\_HCTRL\_MODE\_U<sub>n</sub>** This register configures how the CH1\_POS\_MODE/CH1\_NEG\_MODE settings will be modified when the control signal is high. (R/W) 0: No modification; 1: Invert behaviour (increase -> decrease, decrease -> increase); 2, 3: Inhibit counter modification

**PCNT\_CH1\_POS\_MODE\_U<sub>n</sub>** This register sets the behaviour when the signal input of channel 1 detects a positive edge. (R/W) 1: Increment the counter; 2: Decrement the counter; 0, 3: No effect on counter

**PCNT\_CH1\_NEG\_MODE\_U<sub>n</sub>** This register sets the behaviour when the signal input of channel 1 detects a negative edge. (R/W) 1: Increment the counter; 2: Decrement the counter; 0, 3: No effect on counter

**PCNT\_CH0\_LCTRL\_MODE\_U<sub>n</sub>** This register configures how the CH0\_POS\_MODE/CH0\_NEG\_MODE settings will be modified when the control signal is low. (R/W) 0: No modification; 1: Invert behaviour (increase -> decrease, decrease -> increase); 2, 3: Inhibit counter modification

**PCNT\_CH0\_HCTRL\_MODE\_U<sub>n</sub>** This register configures how the CH0\_POS\_MODE/CH0\_NEG\_MODE settings will be modified when the control signal is high. (R/W) 0: No modification; 1: Invert behaviour (increase -> decrease, decrease -> increase); 2, 3: Inhibit counter modification

**PCNT\_CH0\_POS\_MODE\_U<sub>n</sub>** This register sets the behaviour when the signal input of channel 0 detects a positive edge. (R/W) 1: Increase the counter; 2: Decrease the counter; 0, 3: No effect on counter

**PCNT\_CH0\_NEG\_MODE\_U<sub>n</sub>** This register sets the behaviour when the signal input of channel 0 detects a negative edge. (R/W) 1: Increase the counter; 2: Decrease the counter; 0, 3: No effect on counter

**PCNT\_THR\_THRES1\_EN\_U<sub>n</sub>** This is the enable bit for unit *n*'s thres1 comparator. (R/W)

Continued on the next page...

**Register 17.1. PCNT\_U $n$ \_CONF0\_REG ( $n$ : 0-7) (0x0+0x0C\* $n$ )**

Continued from the previous page...

**PCNT\_THR\_THRES0\_EN\_U $n$**  This is the enable bit for unit  $n$ 's thres0 comparator. (R/W)**PCNT\_THR\_L\_LIM\_EN\_U $n$**  This is the enable bit for unit  $n$ 's thr\_l\_lim comparator. (R/W)**PCNT\_THR\_H\_LIM\_EN\_U $n$**  This is the enable bit for unit  $n$ 's thr\_h\_lim comparator. (R/W)**PCNT\_THR\_ZERO\_EN\_U $n$**  This is the enable bit for unit  $n$ 's zero comparator. (R/W)**PCNT\_FILTER\_EN\_U $n$**  This is the enable bit for unit  $n$ 's input filter. (R/W)**PCNT\_FILTER\_THRES\_U $n$**  This sets the maximum threshold, in APB\_CLK cycles, for the filter. Any pulses lasting shorter than this will be ignored when the filter is enabled. (R/W)**Register 17.2. PCNT\_U $n$ \_CONF1\_REG ( $n$ : 0-7) (0x4+0x0C\* $n$ )**

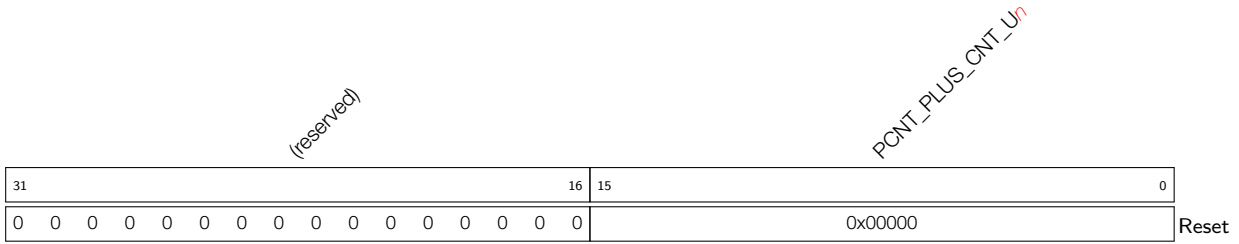
31	16	15	0
0x000		0x000	
			Reset

**PCNT\_CNT\_THRES1\_U $n$**  This register is used to configure the thres1 value for unit  $n$ . (R/W)**PCNT\_CNT\_THRES0\_U $n$**  This register is used to configure the thres0 value for unit  $n$ . (R/W)**Register 17.3. PCNT\_U $n$ \_CONF2\_REG ( $n$ : 0-7) (0x8+0x0C\* $n$ )**

31	16	15	0
0x000		0x000	
			Reset

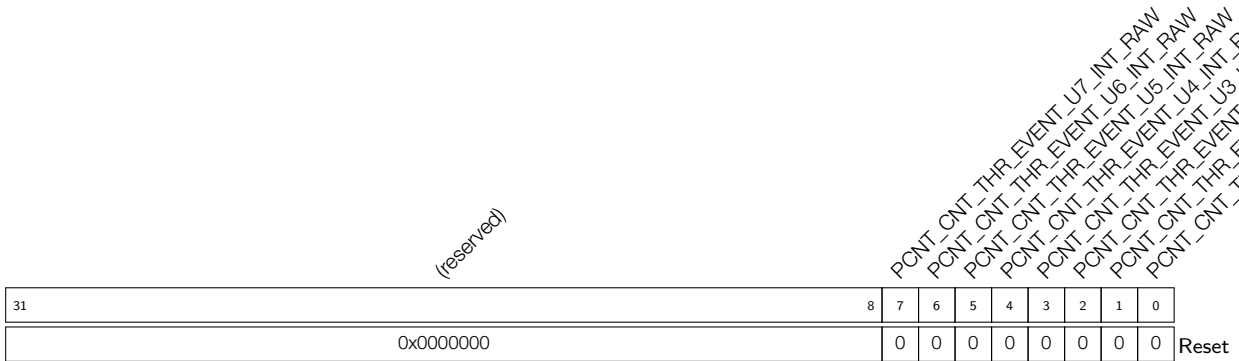
**PCNT\_CNT\_L\_LIM\_U $n$**  This register is used to configure the thr\_l\_lim value for unit  $n$ . (R/W)**PCNT\_CNT\_H\_LIM\_U $n$**  This register is used to configure the thr\_h\_lim value for unit  $n$ . (R/W)

**Register 17.4. PCNT\_U $n$ \_CNT\_REG ( $n$ : 0-7) (0x28+0x0C\* $n$ )**



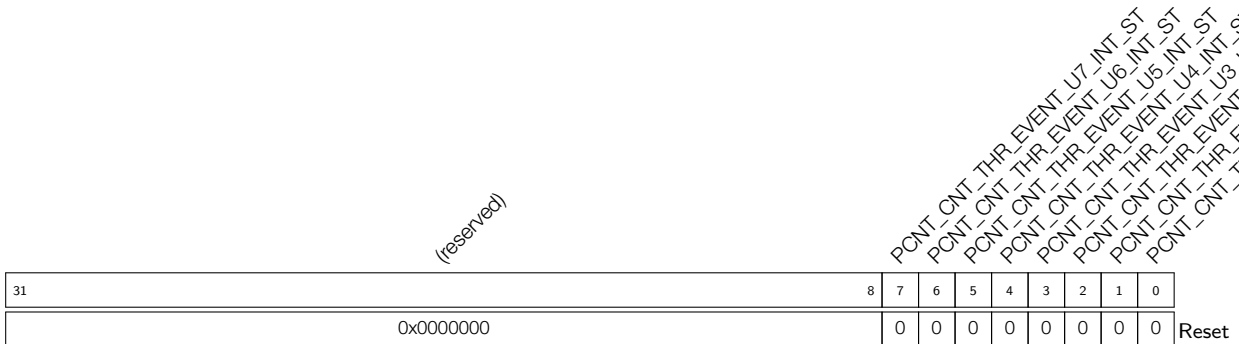
**PCNT\_PLUS\_CNT\_U $n$**  This register stores the current pulse count value for unit  $n$ . (RO)

**Register 17.5. PCNT\_INT\_RAW\_REG (0x0080)**



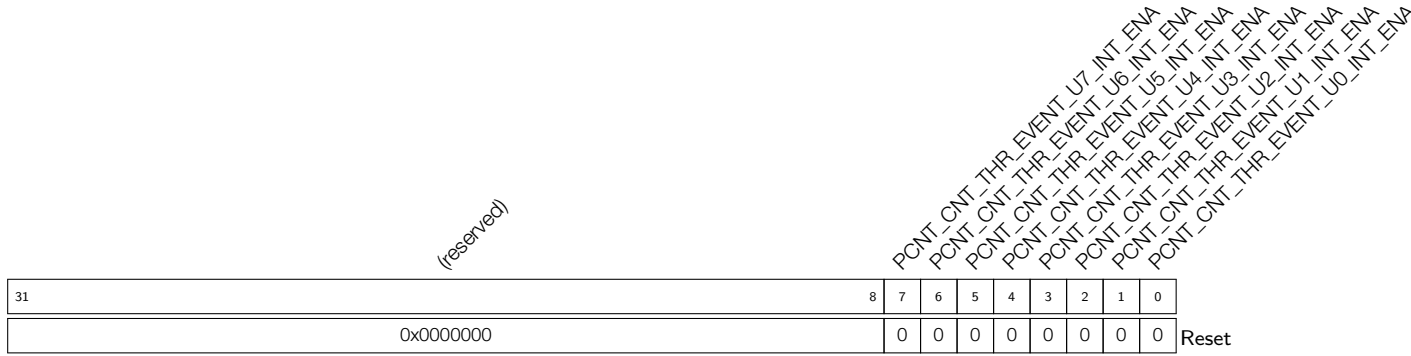
**PCNT\_CNT\_THR\_EVENT\_U $n$ \_INT\_RAW** The raw interrupt status bit for the PCNT\_CNT\_THR\_EVENT\_U $n$ \_INT interrupt. (RO)

**Register 17.6. PCNT\_INT\_ST\_REG (0x0084)**



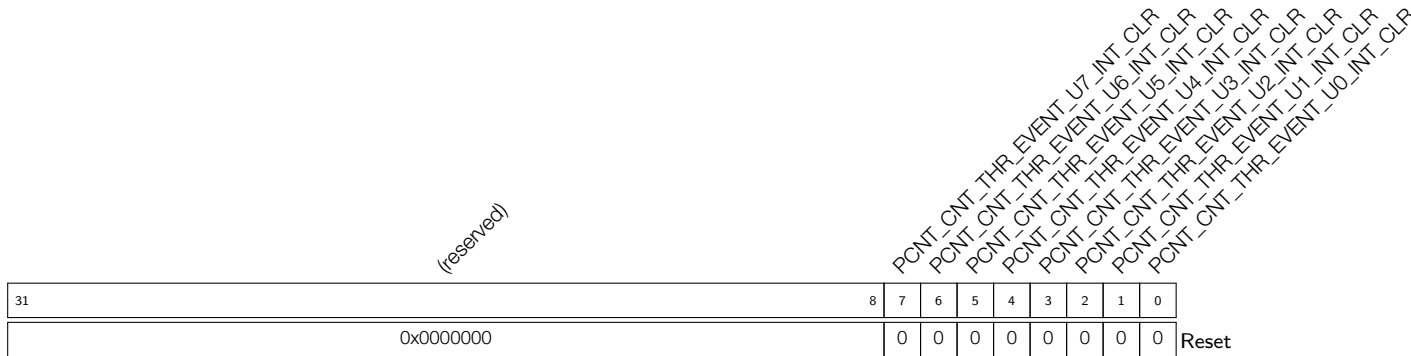
**PCNT\_CNT\_THR\_EVENT\_U $n$ \_INT\_ST** The masked interrupt status bit for the PCNT\_CNT\_THR\_EVENT\_U $n$ \_INT interrupt. (RO)

**Register 17.7. PCNT\_INT\_ENA\_REG (0x0088)**



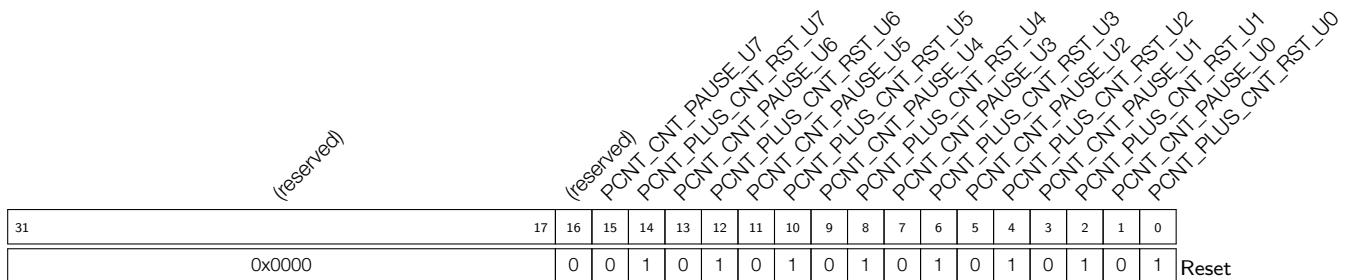
**PCNT\_CNT\_THR\_EVENT\_U $n$ \_INT\_ENA** The interrupt enable bit for the **PCNT\_CNT\_THR\_EVENT\_U $n$ \_INT** interrupt. (R/W)

**Register 17.8. PCNT\_INT\_CLR\_REG (0x008c)**



**PCNT\_CNT\_THR\_EVENT\_U $n$ \_INT\_CLR** Set this bit to clear the **PCNT\_CNT\_THR\_EVENT\_U $n$ \_INT** interrupt. (WO)

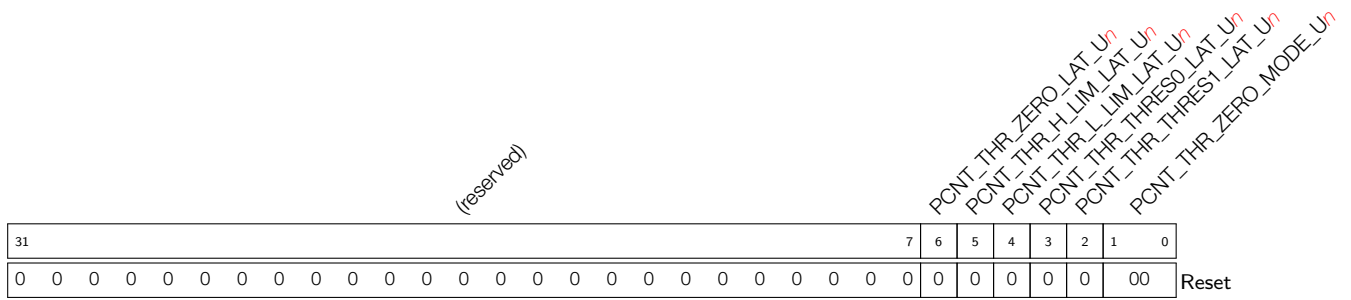
**Register 17.9. PCNT\_CTRL\_REG (0x00b0)**



**PCNT\_CNT\_PAUSE\_U $n$**  Set this bit to freeze unit  $n$ 's counter. (R/W)

**PCNT\_PLUS\_CNT\_RST\_U $n$**  Set this bit to clear unit  $n$ 's counter. (R/W)

**Register 17.10. PCNT\_U $n$ \_STATUS\_REG ( $n$ : 0-7) (0x90+0x0C\* $n$ )**



- PCNT\_THR\_ZERO\_LAT\_U $n$**  The last interrupt happened on counter for unit  $n$  reaching 0. (RO)
- PCNT\_THR\_H\_LIM\_LAT\_U $n$**  The last interrupt happened on counter for unit  $n$  reaching thr\_h\_lim. (RO)
- PCNT\_THR\_L\_LIM\_LAT\_U $n$**  The last interrupt happened on counter for unit  $n$  reaching thr\_l\_lim. (RO)
- PCNT\_THR\_THRES0\_LAT\_U $n$**  The last interrupt happened on counter for unit  $n$  reaching thres0. (RO)
- PCNT\_THR\_THRES1\_LAT\_U $n$**  The last interrupt happened on counter for unit  $n$  reaching thres1. (RO)
- PCNT\_THR\_ZERO\_MODE\_U $n$**  This register stores the current status of the counter. 0: counting value is +0 (the counter values are represented by signed binary numbers); 1: counting value is -0; 2: counting value is negative; 3: counting value is positive. (RO)

## 18 Timer Group (TIMG)

### 18.1 Introduction

There are four general-purpose timers embedded in the ESP32. They are all 64-bit generic timers based on 16-bit prescalers and 64-bit auto-reload-capable up/downcounters.

The ESP32 contains two timer modules, each containing two timers. The two timers in a block are indicated by an  $x$  in  $TIMG_n\_Tx$ ; the blocks themselves are indicated by an  $n$ .

The timers feature:

- A 16-bit clock prescaler, from 2 to 65536
- A 64-bit time-base counter
- Configurable up/down time-base counter: incrementing or decrementing
- Halt and resume of time-base counter
- Auto-reload at alarm
- Software-controlled instant reload
- Level and edge interrupt generation

### 18.2 Functional Description

#### 18.2.1 16-bit Prescaler

Each timer uses the APB clock (APB\_CLK, normally 80 MHz) as the basic clock. This clock is then divided down by a 16-bit prescaler which generates the time-base counter clock (TB\_clk). Every cycle of TB\_clk causes the time-base counter to increment or decrement by one. The timer must be disabled ( $TIMG_n\_Tx\_EN$  is cleared) before changing the prescaler divisor which is configured by  $TIMG_n\_Tx\_DIVIDER$  register; changing it on an enabled timer can lead to unpredictable results. The prescaler can divide the APB clock by a factor from 2 to 65536. Specifically, when  $TIMG_n\_Tx\_DIVIDER$  is either 1 or 2, the clock divisor is 2; when  $TIMG_n\_Tx\_DIVIDER$  is 0, the clock divisor is 65536. Any other value will cause the clock to be divided by exactly that value.

#### 18.2.2 64-bit Time-base Counter

The 64-bit time-base counter can be configured to count either up or down, depending on whether  $TIMG_n\_Tx\_INCREASE$  is set or cleared, respectively. It supports both auto-reload and software instant reload. An alarm event can be set when the counter reaches a value specified by the software.

Counting can be enabled and disabled by setting and clearing  $TIMG_n\_Tx\_EN$ . Clearing this bit essentially freezes the counter, causing it to neither count up nor count down; instead, it retains its value until  $TIMG_n\_Tx\_EN$  is set again. Reloading the counter when  $TIMG_n\_Tx\_EN$  is cleared will change its value, but counting will not be resumed until  $TIMG_n\_Tx\_EN$  is set.

Software can set a new counter value by setting registers  $TIMG_n\_Tx\_LOAD\_LO$  and  $TIMG_n\_Tx\_LOAD\_HI$  to the intended new value. The hardware will ignore these register settings until a reload; a reload will cause the contents of these registers to be copied to the counter itself. A reload event can be triggered by an alarm (auto-reload at alarm) or by software (software instant reload). To enable auto-reload at alarm, the register  $TIMG_n\_Tx\_AUTORELOAD$  should be set. If auto-reload at alarm is not enabled, the time-base counter will continue incrementing or decrementing after the alarm. To trigger a software instant reload, any value can be written to the register  $TIMG_n\_Tx\_INSTANT\_RELOAD$ .



LOAD\_REG; this will cause the counter value to change instantly. Software can also change the direction of the time-base counter instantly by changing the value of TIMG $n$ \_Tx\_INCREASE.

The time-base counter can also be read by software, but because the counter is 64-bit, the CPU can only get the value as two 32-bit values, the counter value needs to be latched onto TIMG $n$ \_TxLO\_REG and TIMG $n$ \_TxHI\_REG first. This is done by writing any value to TIMG $n$ \_TxUPDATE\_REG; this will instantly latch the 64-bit timer value onto the two registers. Software can then read them at any point in time. This approach stops the timer value being read erroneously when a carry-over happens between reading the low and high word of the timer value.

### 18.2.3 Alarm Generation

The timer can trigger an alarm, which can cause a reload and/or an interrupt to occur. The alarm is triggered when the alarm registers TIMG $n$ \_Tx\_ALARMLO\_REG and TIMG $n$ \_Tx\_ALARMHI\_REG match the current timer value. In order to simplify the scenario where these registers are set 'too late' and the counter has already passed these values, the alarm also triggers when the current timer value is higher (for an up-counting timer) or lower (for a down-counting timer) than the current alarm value: if this is the case, the alarm will be triggered immediately upon loading the alarm registers. The timer alarm enable bit is automatically cleared once an alarm occurs.

### 18.2.4 MWDT

Each timer module also contains a Main System Watchdog Timer and its associated registers. While these registers are described here, their functional description can be found in the chapter entitled [Watchdog Timer](#).

### 18.2.5 Interrupts

- TIMG $n$ \_Tx\_INT\_WDT\_INT: Generated when a watchdog timer interrupt stage times out.
- TIMG $n$ \_Tx\_INT\_T1\_INT: An alarm event on timer 1 generates this interrupt.
- TIMG $n$ \_Tx\_INT\_T0\_INT: An alarm event on timer 0 generates this interrupt.

## 18.3 Register Summary

Name	Description	TIMG0	TIMG1	Acc
<b>Timer 0 configuration and control registers</b>				
<a href="#">TIMG<math>n</math>_T0CONFIG_REG</a>	Timer 0 configuration register	0x3FF5F000	0x3FF60000	R/W
<a href="#">TIMG<math>n</math>_T0LO_REG</a>	Timer 0 current value, low 32 bits	0x3FF5F004	0x3FF60004	RO
<a href="#">TIMG<math>n</math>_T0HI_REG</a>	Timer 0 current value, high 32 bits	0x3FF5F008	0x3FF60008	RO
<a href="#">TIMG<math>n</math>_T0UPDATE_REG</a>	Write to copy current timer value to TIMG $n$ _T0_(LO/HI)_REG	0x3FF5F00C	0x3FF6000C	WO
<a href="#">TIMG<math>n</math>_T0ALARMLO_REG</a>	Timer 0 alarm value, low 32 bits	0x3FF5F010	0x3FF60010	R/W
<a href="#">TIMG<math>n</math>_T0ALARMHI_REG</a>	Timer 0 alarm value, high bits	0x3FF5F014	0x3FF60014	R/W
<a href="#">TIMG<math>n</math>_T0LOADLO_REG</a>	Timer 0 reload value, low 32 bits	0x3FF5F018	0x3FF60018	R/W
<a href="#">TIMG<math>n</math>_T0LOADHI_REG</a>	Timer 0 reload value, high 32 bits	0x3FF5F01C	0x3FF6001C	R/W
<a href="#">TIMG<math>n</math>_T0LOAD_REG</a>	Write to reload timer from TIMG $n$ _T0_(LOADLOLOADHI)_REG	0x3FF5F020	0x3FF60020	WO
<b>Timer 1 configuration and control registers</b>				
<a href="#">TIMG<math>n</math>_T1CONFIG_REG</a>	Timer 1 configuration register	0x3FF5F024	0x3FF60024	R/W
<a href="#">TIMG<math>n</math>_T1LO_REG</a>	Timer 1 current value, low 32 bits	0x3FF5F028	0x3FF60028	RO
<a href="#">TIMG<math>n</math>_T1HI_REG</a>	Timer 1 current value, high 32 bits	0x3FF5F02C	0x3FF6002C	RO

Name	Description	TIMG0	TIMG1	Acc
<a href="#">TIMG<sub>n</sub>_T1UPDATE_REG</a>	Write to copy current timer value to TIMG <sub>n</sub> _T1_(LO/HI)_REG	0x3FF5F030	0x3FF60030	WO
<a href="#">TIMG<sub>n</sub>_T1ALARMLO_REG</a>	Timer 1 alarm value, low 32 bits	0x3FF5F034	0x3FF60034	R/W
<a href="#">TIMG<sub>n</sub>_T1ALARMHI_REG</a>	Timer 1 alarm value, high 32 bits	0x3FF5F038	0x3FF60038	R/W
<a href="#">TIMG<sub>n</sub>_T1LOADLO_REG</a>	Timer 1 reload value, low 32 bits	0x3FF5F03C	0x3FF6003C	R/W
<a href="#">TIMG<sub>n</sub>_T1LOADHI_REG</a>	Timer 1 reload value, high 32 bits	0x3FF5F040	0x3FF60040	R/W
<a href="#">TIMG<sub>n</sub>_T1LOAD_REG</a>	Write to reload timer from TIMG <sub>n</sub> _T1_(LOADLOLOADHI)_REG	0x3FF5F044	0x3FF60044	WO
<b>System watchdog timer configuration and control registers</b>				
<a href="#">TIMG<sub>n</sub>_Tx_WDTCONFIG0_REG</a>	Watchdog timer configuration register	0x3FF5F048	0x3FF60048	R/W
<a href="#">TIMG<sub>n</sub>_Tx_WDTCONFIG1_REG</a>	Watchdog timer prescaler register	0x3FF5F04C	0x3FF6004C	R/W
<a href="#">TIMG<sub>n</sub>_Tx_WDTCONFIG2_REG</a>	Watchdog timer stage 0 timeout value	0x3FF5F050	0x3FF60050	R/W
<a href="#">TIMG<sub>n</sub>_Tx_WDTCONFIG3_REG</a>	Watchdog timer stage 1 timeout value	0x3FF5F054	0x3FF60054	R/W
<a href="#">TIMG<sub>n</sub>_Tx_WDTCONFIG4_REG</a>	Watchdog timer stage 2 timeout value	0x3FF5F058	0x3FF60058	R/W
<a href="#">TIMG<sub>n</sub>_Tx_WDTCONFIG5_REG</a>	Watchdog timer stage 3 timeout value	0x3FF5F05C	0x3FF6005C	R/W
<a href="#">TIMG<sub>n</sub>_Tx_WDTFEED_REG</a>	Write to feed the watchdog timer	0x3FF5F060	0x3FF60060	WO
<a href="#">TIMG<sub>n</sub>_Tx_WDTWPROTECT_REG</a>	Watchdog write protect register	0x3FF5F064	0x3FF60064	R/W
<b>Configuration and Control Register for RTC CALI</b>				
<a href="#">TIMG<sub>n</sub>_RTCCALICFG_REG</a>	RTC calibration configuration register	0x3FF5F068	0x3FF60068	varies
<a href="#">TIMG<sub>n</sub>_RTCCALICFG1_REG</a>	RTC calibration configuration register 1	0x3FF5F06C	0x3FF6006C	RO
<b>Interrupt registers</b>				
<a href="#">TIMG<sub>n</sub>_Tx_INT_ENA_REG</a>	Interrupt enable bits	0x3FF5F098	0x3FF60098	R/W
<a href="#">TIMG<sub>n</sub>_Tx_INT_RAW_REG</a>	Raw interrupt status	0x3FF5F09C	0x3FF6009C	RO
<a href="#">TIMG<sub>n</sub>_Tx_INT_ST_REG</a>	Masked interrupt status	0x3FF5F0A0	0x3FF600A0	RO
<a href="#">TIMG<sub>n</sub>_Tx_INT_CLR_REG</a>	Interrupt clear bits	0x3FF5F0A4	0x3FF600A4	WO

## 18.4 Registers

Register 18.1. **TIMG<sub>n</sub>\_TxCONFIG\_REG (x: 0-1) (0x0+0x24\*x)**

<i>TIMG<sub>n</sub>_Tx_EN</i>				<i>TIMG<sub>n</sub>_Tx_INCREASE</i>				<i>TIMG<sub>n</sub>_Tx_AUTORELOAD</i>				<i>TIMG<sub>n</sub>_Tx_DIVIDER</i>				<i>TIMG<sub>n</sub>_Tx_EDGE_INT_EN</i>				<i>TIMG<sub>n</sub>_Tx_LEVEL_INT_EN</i>				<i>TIMG<sub>n</sub>_Tx_ALARM_EN</i>			
31	30	29	28									13	12	11	10												
0	1	1	0x00001								0	0	0	0													

Reset

**TIMG<sub>n</sub>\_Tx\_EN** When set, the timer *x* time-base counter is enabled. (R/W)

**TIMG<sub>n</sub>\_Tx\_INCREASE** When set, the timer *x* time-base counter will increment every clock tick. When cleared, the timer *x* time-base counter will decrement. (R/W)

**TIMG<sub>n</sub>\_Tx\_AUTORELOAD** When set, timer *x* auto-reload at alarm is enabled. (R/W)

**TIMG<sub>n</sub>\_Tx\_DIVIDER** Timer *x* clock (*Tx\_clk*) prescale value. (R/W)

**TIMG<sub>n</sub>\_Tx\_EDGE\_INT\_EN** When set, an alarm will generate an edge type interrupt. (R/W)

**TIMG<sub>n</sub>\_Tx\_LEVEL\_INT\_EN** When set, an alarm will generate a level type interrupt. (R/W)

**TIMG<sub>n</sub>\_Tx\_ALARM\_EN** When set, the alarm is enabled. This bit is automatically cleared once an alarm occurs. (R/W)

Register 18.2. **TIMG<sub>n</sub>\_TxLO\_REG (x: 0-1) (0x4+0x24\*x)**

31	0
0x00000000	

Reset

**TIMG<sub>n</sub>\_TxLO\_REG** After writing to **TIMG<sub>n</sub>\_TxUPDATE\_REG**, the low 32 bits of the time-base counter of timer *x* can be read here. (RO)

Register 18.3. **TIMG<sub>n</sub>\_TxHI\_REG (x: 0-1) (0x8+0x24\*x)**

31	0
0x00000000	

Reset

**TIMG<sub>n</sub>\_TxHI\_REG** After writing to **TIMG<sub>n</sub>\_TxUPDATE\_REG**, the high 32 bits of the time-base counter of timer *x* can be read here. (RO)

**Register 18.4. TIMG<sub>n</sub>\_TXUPDATE\_REG (x: 0-1) (0xC+0x24\*x)**

31	0
0x00000000	

Reset

**TIMG<sub>n</sub>\_TXUPDATE\_REG** Write any value to trigger a timer *x* time-base counter value update (timer *x* current value will be stored in registers above). (WO)

**Register 18.5. TIMG<sub>n</sub>\_TXALARMLO\_REG (x: 0-1) (0x10+0x24\*x)**

31	0
0x00000000	

Reset

**TIMG<sub>n</sub>\_TXALARMLO\_REG** Timer *x* alarm trigger time-base counter value, low 32 bits. (R/W)

**Register 18.6. TIMG<sub>n</sub>\_TXALARMHI\_REG (x: 0-1) (0x14+0x24\*x)**

31	0
0x00000000	

Reset

**TIMG<sub>n</sub>\_TXALARMHI\_REG** Timer *x* alarm trigger time-base counter value, high 32 bits. (R/W)

**Register 18.7. TIMG<sub>n</sub>\_TXLOADLO\_REG (x: 0-1) (0x18+0x24\*x)**

31	0
0x00000000	

Reset

**TIMG<sub>n</sub>\_TXLOADLO\_REG** Low 32 bits of the value that a reload will load onto timer *x* time-base counter. (R/W)

**Register 18.8. TIMG<sub>n</sub>\_TXLOADHI\_REG (x: 0-1) (0x1C+0x24\*x)**

31	0
0x00000000	

Reset

**TIMG<sub>n</sub>\_TXLOADHI\_REG** High 32 bits of the value that a reload will load onto timer *x* time-base counter. (R/W)

**Register 18.9. TIMG<sub>n</sub>\_TXLOAD\_REG (x: 0-1) (0x20+0x24\*x)**

31	0
0x00000000	
Reset	

**TIMG<sub>n</sub>\_TXLOAD\_REG** Write any value to trigger a timer *x* time-base counter reload. (WO)

**Register 18.10. TIMG<sub>n</sub>\_TX\_WDTCONFIG0\_REG (0x0048)**

<i>TIMG<sub>n</sub>_TX_WDT_EN</i>		<i>TIMG<sub>n</sub>_TX_WDT_STG0</i>		<i>TIMG<sub>n</sub>_TX_WDT_STG1</i>		<i>TIMG<sub>n</sub>_TX_WDT_STG2</i>		<i>TIMG<sub>n</sub>_TX_WDT_STG3</i>		<i>TIMG<sub>n</sub>_TX_WDT_EDGE_INT_EN</i>		<i>TIMG<sub>n</sub>_TX_WDT_LEVEL_INT_EN</i>		<i>TIMG<sub>n</sub>_TX_WDT_CPU_RESET_LENGTH</i>		<i>TIMG<sub>n</sub>_TX_WDT_SYS_RESET_LENGTH</i>		<i>TIMG<sub>n</sub>_TX_WDT_FLASHBOOT_MOD_EN</i>		
31	30	29	28	27	26	25	24	23	22	21	20	18	17	15	14					
0	0	0	0	0	0	0	0	0	0	0	0x1	0x1	0x1	0x1	1	Reset				

**TIMG<sub>n</sub>\_TX\_WDT\_EN** When set, MWDT is enabled. (R/W)

**TIMG<sub>n</sub>\_TX\_WDT\_STG0** Stage 0 configuration. 0: off, 1: interrupt, 2: reset CPU, 3: reset system. (R/W)

**TIMG<sub>n</sub>\_TX\_WDT\_STG1** Stage 1 configuration. 0: off, 1: interrupt, 2: reset CPU, 3: reset system. (R/W)

**TIMG<sub>n</sub>\_TX\_WDT\_STG2** Stage 2 configuration. 0: off, 1: interrupt, 2: reset CPU, 3: reset system. (R/W)

**TIMG<sub>n</sub>\_TX\_WDT\_STG3** Stage 3 configuration. 0: off, 1: interrupt, 2: reset CPU, 3: reset system. (R/W)

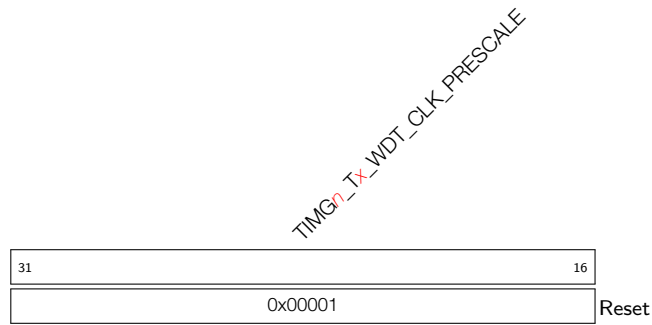
**TIMG<sub>n</sub>\_TX\_WDT\_EDGE\_INT\_EN** When set, an edge type interrupt will occur at the timeout of a stage configured to generate an interrupt. (R/W)

**TIMG<sub>n</sub>\_TX\_WDT\_LEVEL\_INT\_EN** When set, a level type interrupt will occur at the timeout of a stage configured to generate an interrupt. (R/W)

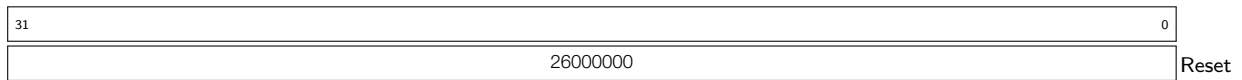
**TIMG<sub>n</sub>\_TX\_WDT\_CPU\_RESET\_LENGTH** CPU reset signal length selection. 0: 100 ns, 1: 200 ns, 2: 300 ns, 3: 400 ns, 4: 500 ns, 5: 800 ns, 6: 1.6  $\mu$ s, 7: 3.2  $\mu$ s. (R/W)

**TIMG<sub>n</sub>\_TX\_WDT\_SYS\_RESET\_LENGTH** System reset signal length selection. 0: 100 ns, 1: 200 ns, 2: 300 ns, 3: 400 ns, 4: 500 ns, 5: 800 ns, 6: 1.6  $\mu$ s, 7: 3.2  $\mu$ s. (R/W)

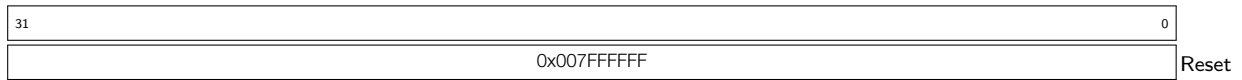
**TIMG<sub>n</sub>\_TX\_WDT\_FLASHBOOT\_MOD\_EN** When set, Flash boot protection is enabled. (R/W)

**Register 18.11. TIMG<sub>n</sub>\_Tx\_WDTCONFIG1\_REG (0x004c)**

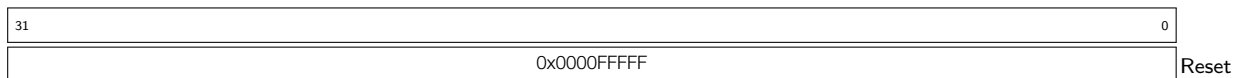
**TIMG<sub>n</sub>\_Tx\_WDT\_CLK\_PRESCALE** MWDT clock prescale value. MWDT clock period = 12.5 ns \*  
 TIMG<sub>n</sub>\_Tx\_WDT\_CLK\_PRESCALE. (R/W)

**Register 18.12. TIMG<sub>n</sub>\_Tx\_WDTCONFIG2\_REG (0x0050)**

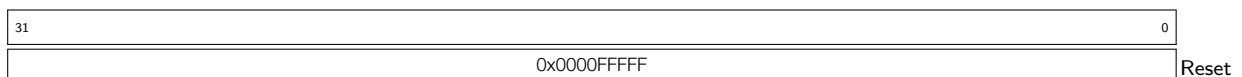
**TIMG<sub>n</sub>\_Tx\_WDTCONFIG2\_REG** Stage 0 timeout value, in MWDT clock cycles. (R/W)

**Register 18.13. TIMG<sub>n</sub>\_Tx\_WDTCONFIG3\_REG (0x0054)**

**TIMG<sub>n</sub>\_Tx\_WDTCONFIG3\_REG** Stage 1 timeout value, in MWDT clock cycles. (R/W)

**Register 18.14. TIMG<sub>n</sub>\_Tx\_WDTCONFIG4\_REG (0x0058)**

**TIMG<sub>n</sub>\_Tx\_WDTCONFIG4\_REG** Stage 2 timeout value, in MWDT clock cycles. (R/W)

**Register 18.15. TIMG<sub>n</sub>\_Tx\_WDTCONFIG5\_REG (0x005c)**

**TIMG<sub>n</sub>\_Tx\_WDTCONFIG5\_REG** Stage 3 timeout value, in MWDT clock cycles. (R/W)

**Register 18.16. TIMG<sub>n</sub>\_Tx\_WDTFEED\_REG (0x0060)**

31	0
0x00000000	
Reset	

**TIMG<sub>n</sub>\_Tx\_WDTFEED\_REG** Write any value to feed the MWDT. (WO)

**Register 18.17. TIMG<sub>n</sub>\_Tx\_WDTWPROTECT\_REG (0x0064)**

31	0
0x050D83AA1	
Reset	

**TIMG<sub>n</sub>\_Tx\_WDTWPROTECT\_REG** If the register contains a different value than its reset value, write protection is enabled. (R/W)

**Register 18.18. TIMG<sub>n</sub>\_RTCCALICFG\_REG (0x0068)**

<i>TIMG<sub>n</sub>_RTC_CALI_START</i>		<i>TIMG<sub>n</sub>_RTC_CALI_MAX</i>		<i>TIMG<sub>n</sub>_RTC_CALI_RDY</i>		<i>TIMG<sub>n</sub>_RTC_CALI_CLK_SEL</i>		<i>TIMG<sub>n</sub>_RTC_CALI_START_CYCLING</i>		<i>(reserved)</i>		
31	30	16	15	14	13	12	11					0
0x01		0		0x1		1		0 0 0 0 0 0 0 0 0 0				Reset

**TIMG<sub>n</sub>\_RTC\_CALI\_START\_CYCLING** Reserved. (R/W)

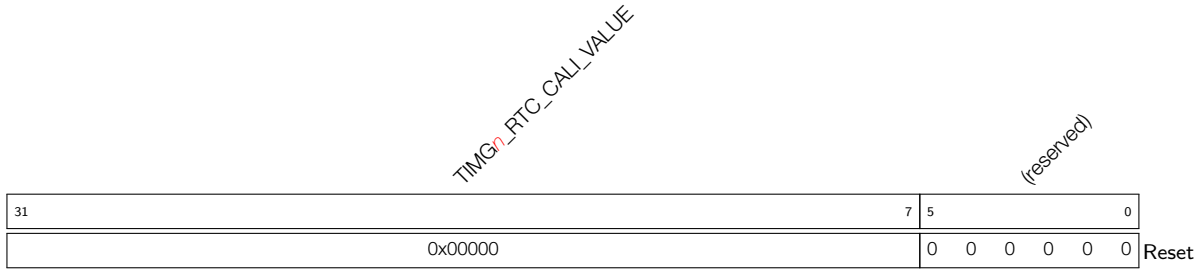
**TIMG<sub>n</sub>\_RTC\_CALI\_CLK\_SEL** Used to select the clock to be calibrated. 0: RTC\_CLK. 1: RTC20M\_D256\_CLK. 2: XTAL32K\_CLK. (R/W)

**TIMG<sub>n</sub>\_RTC\_CALI\_RDY** Set this bit to mark the completion of calibration. (RO)

**TIMG<sub>n</sub>\_RTC\_CALI\_MAX** Calibration time, in cycles of the clock to be calibrated. (R/W)

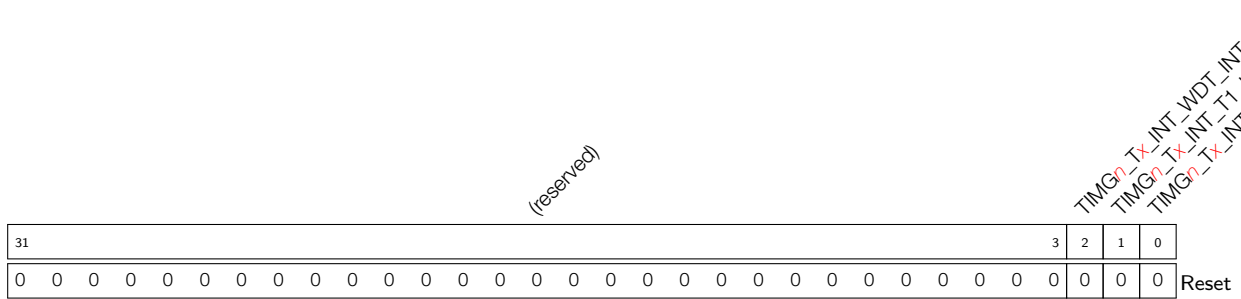
**TIMG<sub>n</sub>\_RTC\_CALI\_START** Set this bit to starts calibration. (R/W)

**Register 18.19. TIMG<sub>n</sub>\_RTCCALICFG1\_REG (0x006C)**



**TIMG<sub>n</sub>\_RTC\_CALI\_VALUE** Calibration value when cycles of clock to be calibrated reach TIMG<sub>n</sub>\_RTC\_CALI\_MAX, in unit of XTAL\_CLK clock cycles. (RO)

**Register 18.20. TIMG<sub>n</sub>\_Tx\_INT\_ENA\_REG (0x0098)**



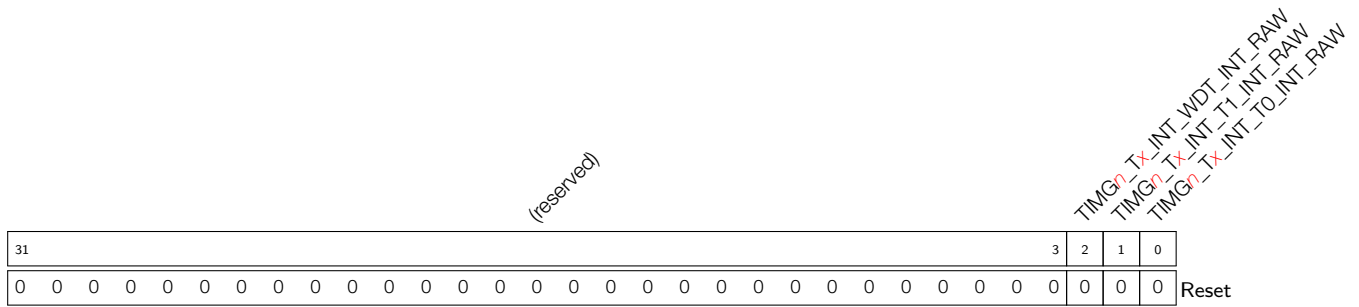
**TIMG<sub>n</sub>\_Tx\_INT\_WDT\_INT\_ENA** The interrupt enable bit for the TIMG<sub>n</sub>\_Tx\_INT\_WDT\_INT interrupt. (R/W) (R/W)

**TIMG<sub>n</sub>\_Tx\_INT\_T1\_INT\_ENA** The interrupt enable bit for the TIMG<sub>n</sub>\_Tx\_INT\_T1\_INT interrupt. (R/W) (R/W)

**TIMG<sub>n</sub>\_Tx\_INT\_TO\_INT\_ENA** The interrupt enable bit for the TIMG<sub>n</sub>\_Tx\_INT\_TO\_INT interrupt. (R/W) (R/W)



**Register 18.21. TIMG<sub>n</sub>\_Tx\_INT\_RAW\_REG (0x009c)**

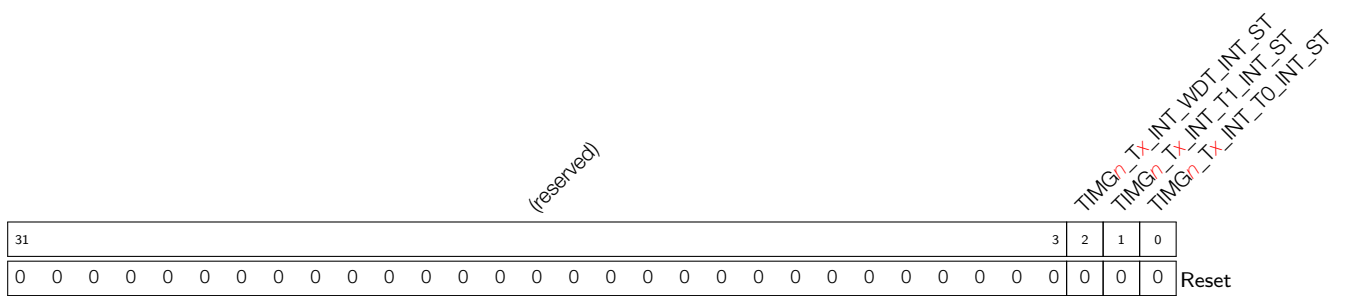


**TIMG<sub>n</sub>\_Tx\_INT\_WDT\_INT\_RAW** The raw interrupt status bit for the TIMG<sub>n</sub>\_Tx\_INT\_WDT\_INT interrupt. (RO)

**TIMG<sub>n</sub>\_Tx\_INT\_T1\_INT\_RAW** The raw interrupt status bit for the TIMG<sub>n</sub>\_Tx\_INT\_T1\_INT interrupt. (RO)

**TIMG<sub>n</sub>\_Tx\_INT\_T0\_INT\_RAW** The raw interrupt status bit for the TIMG<sub>n</sub>\_Tx\_INT\_T0\_INT interrupt. (RO)

**Register 18.22. TIMG<sub>n</sub>\_Tx\_INT\_ST\_REG (0x00a0)**

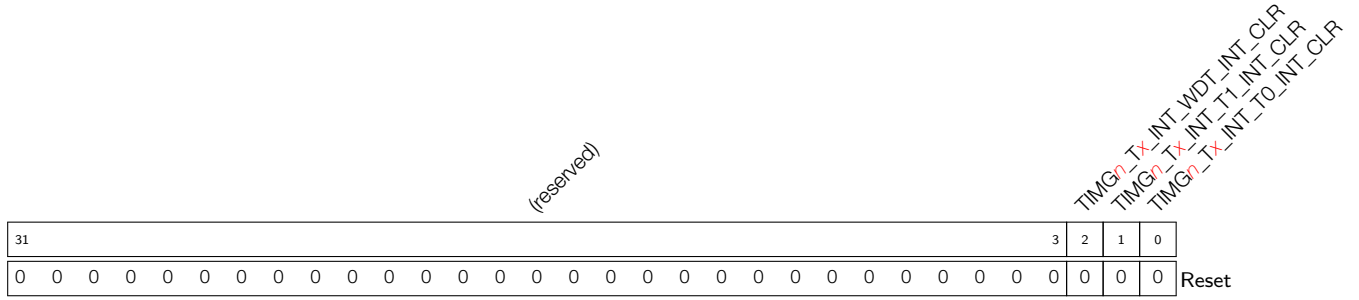


**TIMG<sub>n</sub>\_Tx\_INT\_WDT\_INT\_ST** The masked interrupt status bit for the TIMG<sub>n</sub>\_Tx\_INT\_WDT\_INT interrupt. (RO)

**TIMG<sub>n</sub>\_Tx\_INT\_T1\_INT\_ST** The masked interrupt status bit for the TIMG<sub>n</sub>\_Tx\_INT\_T1\_INT interrupt. (RO)

**TIMG<sub>n</sub>\_Tx\_INT\_T0\_INT\_ST** The masked interrupt status bit for the TIMG<sub>n</sub>\_Tx\_INT\_T0\_INT interrupt. (RO)

**Register 18.23. TIMG<sub>n</sub>\_Tx\_INT\_CLR\_REG (0x00a4)**



**TIMG<sub>n</sub>\_Tx\_INT\_WDT\_INT\_CLR** Set this bit to clear the `TIMGn_Tx_INT_WDT_INT` interrupt. (WO)

**TIMG<sub>n</sub>\_Tx\_INT\_T1\_INT\_CLR** Set this bit to clear the `TIMGn_Tx_INT_T1_INT` interrupt. (WO)

**TIMG<sub>n</sub>\_Tx\_INT\_T0\_INT\_CLR** Set this bit to clear the `TIMGn_Tx_INT_T0_INT` interrupt. (WO)

## 19 Watchdog Timers (WDT)

### 19.1 Introduction

The ESP32 has three watchdog timers: one in each of the two timer modules (called Main System Watchdog Timer, or MWDT) and one in the RTC module (which is called the RTC Watchdog Timer, or RWDT). These watchdog timers are intended to recover from an unforeseen fault, causing the application program to abandon its normal sequence. A watchdog timer has four stages. Each stage may take one out of three or four actions upon the expiry of a programmed period of time for this stage, unless the watchdog is fed or disabled. The actions are: interrupt, CPU reset, core reset and system reset. Only the RWDT can trigger the system reset, and is able to reset the entire chip and the main system including the RTC itself. A timeout value can be set for each stage individually.

During flash boot, the RWDT and the first MWDT start automatically in order to detect and recover from booting problems.

### 19.2 Features

- Four stages, each of which can be configured or disabled separately
- Programmable time period for each stage
- One out of three or four possible actions (interrupt, CPU reset, core reset and system reset) upon the expiry of each stage
- 32-bit expiry counter
- Write protection, to prevent the RWDT and MWDT configuration from being inadvertently altered.
- Flash boot protection

If the boot process from an SPI flash does not complete within a predetermined period of time, the watchdog will reboot the entire main system.

### 19.3 Functional Description

#### 19.3.1 Clock

The RWDT is clocked from the RTC slow clock SLOW\_CLK. The MWDT clock source is derived from the APB clock APB\_CLK via a pre-MWDT 16-bit configurable prescaler. For either watchdog, the clock source is fed into the 32-bit expiry counter. When this counter reaches the timeout value of the current stage, the action configured for the stage will execute, the expiry counter will be reset and the next stage will become active.

##### 19.3.1.1 Operating Procedure

When a watchdog timer is enabled, it will proceed in loops from stage 0 to stage 3, then back to stage 0 and start again. The expiry action and time period for each stage can be configured individually.

Every stage can be configured for one of the following actions when the expiry timer reaches the stage's timeout value:

- Trigger an interrupt  
When the stage expires an interrupt is triggered.
- Reset a CPU core  
When the stage expires the designated CPU core will be reset. MWDT0 CPU reset only resets the PRO

CPU. MWDT1 CPU reset only resets the APP CPU. The RWDT CPU reset can reset either of them, or both, or none, depending on configuration.

- Reset the main system

When the stage expires, the main system, including the MWDTs, will be reset. In this article, the main system includes the CPU and all peripherals. The RTC is an exception to this, and it will not be reset.

- Reset the main system and RTC

When the stage expires the main system and the RTC will both be reset. This action is only available in the RWDT.

- Disabled

This stage will have no effects on the system.

When software feeds the watchdog timer, it returns to stage 0 and its expiry counter restarts from 0.

### 19.3.1.2 Write Protection

Both the MWDTs, as well as the RWDT, can be protected from accidental writing. To accomplish this, they have a write-key register (TIMERS\_WDT\_WKEY for the MWDT, RTC\_CNTL\_WDT\_WKEY for the RWDT.) On reset, these registers are initialized to the value 0x50D83AA1. When the value in this register is changed from 0x50D83AA1, write protection is enabled. Writes to any WDT register, including the feeding register (but excluding the write-key register itself), are ignored. The recommended procedure for accessing a WDT is:

1. Disable the write protection
2. Make the required modification or feed the watchdog
3. Re-enable the write protection

### 19.3.1.3 Flash Boot Protection

During flash booting, the MWDT in timer group 0 (TIMGO), as well as the RWDT, are automatically enabled. Stage 0 for the enabled MWDT is automatically configured to reset the system upon expiry; stage 0 for the RWDT resets the RTC when it expires. After booting, the register TIMERS\_WDT\_FLASHBOOT\_MOD\_EN should be cleared to stop the flash boot protection procedure for the MWDT, and RTC\_CNTL\_WDT\_FLASHBOOT\_MOD\_EN should be cleared to do the same for the RWDT. After this, the MWDT and RWDT can be configured by software.

### 19.3.1.4 Registers

The MWDT registers are part of the timer submodule and are described in the [Timer Registers](#) section. The RWDT registers are part of the RTC submodule and are described in the [RTC Registers](#) section.

## 20 eFuse Controller

### 20.1 Introduction

The ESP32 has a number of eFuses which store system parameters. Fundamentally, an eFuse is a single bit of non-volatile memory with the restriction that once an eFuse bit is programmed to 1, it can never be reverted to 0. Software can instruct the eFuse Controller to program each bit for each system parameter as needed.

Some of these system parameters can be read by software using the eFuse Controller. Some of the system parameters are also directly used by hardware modules.

### 20.2 Features

- Configuration of 33 system parameters
- Optional write-protection
- Optional software-read-protection

### 20.3 Functional Description

#### 20.3.1 Structure

Thirty-three system parameters with different bit width are stored in the eFuses. The name of each system parameter and the corresponding bit width are shown in Table 20-1. Among those parameters, `efuse_wr_disable`, `efuse_rd_disable`, `BLK3_part_reserve` and `coding_scheme` are directly used by the eFuse Controller.

Table 20-1. System Parameters

Name	Bit width	Program -Protection by <code>efuse_wr_disable</code>	Software-Read -Protection by <code>efuse_rd_disable</code>	Description
<b><code>efuse_wr_disable</code></b>	16	1	-	controls the eFuse Controller
<b><code>efuse_rd_disable</code></b>	4	0	-	controls the eFuse Controller
<code>flash_crypt_cnt</code>	7	2	-	governs the flash encryption/ decryption
<code>WIFI_MAC_Address</code>	56	3	-	Wi-Fi MAC address and CRC
<code>SPI_pad_config_hd</code>	5	3	-	configures the SPI I/O to a cer- tain pad
<code>XPD_SDIO_REG</code>	1	5	-	powers up the flash regulator
<code>SDIO_TIEH</code>	1	5	-	configures the flash regulator voltage: set to 1 for 3.3 V and set to 0 for 1.8 V
<code>sdio_force</code>	1	5	-	determines whether <code>XPD_SDIO_REG</code> and <code>SDIO_TIEH</code> can control the flash regulator
<b><code>BLK3_part_reserve</code></b>	2	10	3	controls the eFuse controller
<code>SPI_pad_config_clk</code>	5	6	-	configures the SPI I/O to a cer- tain pad

Name	Bit width	Program -Protection by efuse_wr_disable	Software-Read -Protection by efuse_rd_disable	Description
SPI_pad_config_q	5	6	-	configures the SPI I/O to a certain pad
SPI_pad_config_d	5	6	-	configures the SPI I/O to a certain pad
SPI_pad_config_cs0	5	6	-	configures the SPI I/O to a certain pad
flash_crypt_config	4	10	3	governs flash encryption/decryption
<b>coding_scheme*</b>	2	10	3	controls the eFuse Controller
console_debug_disable	1	15	-	disables the ROM BASIC debug console fallback mode when set to 1
abstract_done_0	1	12	-	determines the status of Secure Boot
abstract_done_1	1	13	-	determines the status of Secure Boot
JTAG_disable	1	14	-	disables access to the JTAG controllers so as to effectively disable external use of JTAG
download_dis_encrypt	1	15	-	governs flash encryption/decryption
download_dis_decrypt	1	15	-	governs flash encryption/decryption
download_dis_cache	1	15	-	disables cache when boot mode is the Download Mode
key_status	1	10	3	determines whether BLOCK3 is deployed for user purposes
BLOCK1*	256/192/128	7	0	governs flash encryption/decryption
BLOCK2*	256/192/128	8	1	key for Secure Boot
BLOCK3*	256/192/128	9	2	key for user purposes
disable_app_cpu	1	3	-	disables APP CPU
disable_bt	1	3	-	disables Bluetooth
pkg_version	4	3	-	packaging version
disable_cache	1	3	-	disables cache
CK8M Frequency	8	4	-	RTC8M_CLK frequency
vol_level_hp_inv	2	3	-	stores the voltage level for CPU to run at 240 MHz, or for flash/PSRAM to run at 80 MHz

Name	Bit width	Program -Protection by efuse_wr_disable	Software-Read -Protection by efuse_rd_disable	Description
dig_vol_l6	4	11	-	stores the difference between the digital regulator voltage at level 6 and 1.2 V.
uart_download_dis	1	2	-	permanently disables Download Boot mode when set to 1. Valid only for ESP32 ECO V3.

### 20.3.1.1 System Parameter efuse\_wr\_disable

The system parameter `efuse_wr_disable` determines whether all of the system parameters are write-protected. Since `efuse_wr_disable` is a system parameter as well, it also determines whether itself is write-protected.

If a system parameter is not write-protected, its unprogrammed bits can be programmed from 0 to 1. The bits previously programmed to 1 will remain 1. When a system parameter is write-protected, none of its bits can be programmed: The unprogrammed bits will always remain 0 and the programmed bits will always remain 1.

The write-protection status of each system parameter corresponds to a bit in `efuse_wr_disable`. When the corresponding bit is set to 0, the system parameter is not write-protected. When the corresponding bit is set to 1, the system parameter is write-protected. If a system parameter is already write-protected, it will remain write-protected. The column entitled “Program-Protection by `efuse_wr_disable`” in Table 20-1 lists the corresponding bits that determine the write-protection status of each system parameter.

### 20.3.1.2 System Parameter efuse\_rd\_disable

Of the 33 system parameters, 27 are not constrained by software-read-protection. These are marked by “-” in the column entitled “Software-Read-Protection by `efuse_rd_disable`” in Table 20-1. Those system parameters, some of which are used by software and hardware modules at the same time, can be read by software via the eFuse Controller at any time.

When not software-read-protected, the other six system parameters can both be read by software and used by hardware modules. When they are software-read-protected, they can only be used by the hardware modules.

The column “Software-Read-Protection by `efuse_rd_disable`” in Table 20-1 lists the corresponding bits in `efuse_rd_disable` that determine the software read-protection status of the six system parameters. If a bit in the system parameter `efuse_rd_disable` is 0, the system parameter controlled by the bit is not software-read-protected. If a bit in the system parameter `efuse_rd_disable` is 1, the system parameter controlled by the bit is software-read-protected. If a system parameter is software-read-protected, it will remain in this state.

### 20.3.1.3 System Parameter coding\_scheme

As Table 20-1 shows, only three system parameters, BLOCK1, BLOCK2, and BLOCK3, have variable bit widths. Their bit widths are controlled by another system parameter, `coding_scheme`. Despite their variable bit widths, BLOCK1, BLOCK2, and BLOCK3 are assigned a fixed number of bits in eFuse. There is an encoding mapping

between these three system parameters and their corresponding stored values in eFuse. For details please see Table 20-2.

**Table 20-2. BLOCK1/2/3 Encoding**

coding_scheme[1:0]	Width of BLOCK1/2/3	Coding scheme	Number of bits in eFuse
00/11	256	None	256
01	192	3/4	256
10	128	Repeat	256

The three coding schemes are explained as follows:

- *BLOCKN* represents any of the following three system parameters: BLOCK1, BLOCK2 or BLOCK3.
- *BLOCKN*[255 : 0], *BLOCKN*[191 : 0], and *BLOCKN*[127 : 0] represent each bit of the three system parameters in the three encoding schemes.
- <sup>e</sup>*BLOCKN*[255 : 0] represents each corresponding bit of those system parameters in eFuse after being encoded.

#### None

$${}^e\text{BLOCKN}[255 : 0] = \text{BLOCKN}[255 : 0]$$

#### 3/4

$$\text{BLOCKN}_i^j[7 : 0] = \text{BLOCKN}[48i + 8j + 7 : 48i + 8j] \quad i \in \{0, 1, 2, 3\} \quad j \in \{0, 1, 2, 3, 4, 5\}$$

$${}^e\text{BLOCKN}_i^j[7 : 0] = {}^e\text{BLOCKN}[64i + 8j + 7 : 64i + 8j] \quad i \in \{0, 1, 2, 3\} \quad j \in \{0, 1, 2, 3, 4, 5, 6, 7\}$$

$${}^e\text{BLOCKN}_i^j[7 : 0] = \begin{cases} \text{BLOCKN}_i^j[7 : 0] & j \in \{0, 1, 2, 3, 4, 5\} \\ \text{BLOCKN}_i^0[7 : 0] \oplus \text{BLOCKN}_i^1[7 : 0] \\ \oplus \text{BLOCKN}_i^2[7 : 0] \oplus \text{BLOCKN}_i^3[7 : 0] & j \in \{6\} \\ \oplus \text{BLOCKN}_i^4[7 : 0] \oplus \text{BLOCKN}_i^5[7 : 0] & j \in \{7\} \\ \sum_{l=0}^5 (l+1) \sum_{k=0}^7 \text{BLOCKN}_i^l[k] & j \in \{7\} \end{cases} \quad i \in \{0, 1, 2, 3\}$$

$\oplus$  means bitwise XOR

$\sum$  and + mean summation

#### Repeat

$${}^e\text{BLOCKN}[255 : 128] = {}^e\text{BLOCKN}[127 : 0] = \text{BLOCKN}[127 : 0]$$

### 20.3.1.4 BLK3\_part\_reserve

System parameters coding\_scheme, BLOCK1, BLOCK2, and BLOCK3 are controlled by the parameter BLK3\_part\_reserve.

When the value of BLK3\_part\_reserve is 0, coding\_scheme, BLOCK1, BLOCK2, and BLOCK3 can be set to any value.

When the value of BLK3\_part\_reserve is 1, coding\_scheme BLOCK1 BLOCK2 and BLOCK3 are controlled by 3/4 coding scheme. Meanwhile, *BLOCK3*[143 : 96], namely, <sup>e</sup>*BLOCK3*[191 : 128] is unavailable.



### 20.3.2 Programming of System Parameters

The programming of variable-length system parameters BLOCK1, BLOCK2, and BLOCK3 is different from that of the fixed-length system parameters. **We program the  ${}^e$ BLOCKN[255 : 0] value of encoded system parameters BLOCK1, BLOCK2, and BLOCK3 instead of directly programming the system parameters. The bit width of  ${}^e$ BLOCKN[255 : 0] is always 256.** Fixed-length system parameters, in contrast, are programmed without encoding them first.

Each bit of the 30 fixed-length system parameters and the three encoded variable-length system parameters corresponds to a program register bit, as shown in Table 20-3. The register bits will be used when programming system parameters.

**Table 20-3. Program Registers**

System parameter			Register	
Name	Width	Bit	Name	Bit
efuse_wr_disable	16	[15:0]	EFUSE_BLK0_WDATA0_REG	[15:0]
efuse_rd_disable	4	[3:0]		[19:16]
flash_crypt_cnt	7	[6:0]		[26:20]
uart_download_dis	1	[0]		[27]
WIFI_MAC_Address	56	[31:0]	EFUSE_BLK0_WDATA1_REG	[31:0]
		[55:32]	EFUSE_BLK0_WDATA2_REG	[23:0]
disable_app_cpu	1	[0]	EFUSE_BLK0_WDATA3_REG	[0]
disable_bt	1	[0]		[1]
pkg_version	4	[3:0]		[2], [11:9]
disable_cache	1	[0]		[3]
SPI_pad_config_hd	5	[4:0]		[8:4]
BLK3_part_reserve	1	[0]		[14]
CK8M Frequency	8	[7:0]	EFUSE_BLK0_WDATA4_REG	[7:0]
XPD_SDIO_REG	1	[0]		[14]
SDIO_TIEH	1	[0]		[15]
sdio_force	1	[0]		[16]
SPI_pad_config_clk	5	[4:0]	EFUSE_BLK0_WDATA5_REG	[4:0]
SPI_pad_config_q	5	[4:0]		[9:5]
SPI_pad_config_d	5	[4:0]		[14:10]
SPI_pad_config_cs0	5	[4:0]		[19:15]
vol_level_hp_inv	2	[1:0]		[23:22]
dig_vol_l6	4	[3:0]		[27:24]
flash_crypt_config	4	[3:0]		[31:28]

System parameter			Register	
Name	Width	Bit	Name	Bit
coding_scheme	2	[1:0]	EFUSE_BLK0_WDATA6_REG	[1:0]
console_debug_disable	1	[0]		[2]
abstract_done_0	1	[0]		[4]
abstract_done_1	1	[0]		[5]
JTAG_disable	1	[0]		[6]
download_dis_encrypt	1	[0]		[7]
download_dis_decrypt	1	[0]		[8]
download_dis_cache	1	[0]		[9]
key_status	1	[0]		[10]
BLOCK1	256/192/128	[31:0]		EFUSE_BLK1_WDATA0_REG
		[63:32]	EFUSE_BLK1_WDATA1_REG	[31:0]
		[95:64]	EFUSE_BLK1_WDATA2_REG	[31:0]
		[127:96]	EFUSE_BLK1_WDATA3_REG	[31:0]
		[159:128]	EFUSE_BLK1_WDATA4_REG	[31:0]
		[191:160]	EFUSE_BLK1_WDATA5_REG	[31:0]
		[223:192]	EFUSE_BLK1_WDATA6_REG	[31:0]
		[255:224]	EFUSE_BLK1_WDATA7_REG	[31:0]
BLOCK2	256/192/128	[31:0]	EFUSE_BLK2_WDATA0_REG	[31:0]
		[63:32]	EFUSE_BLK2_WDATA1_REG	[31:0]
		[95:64]	EFUSE_BLK2_WDATA2_REG	[31:0]
		[127:96]	EFUSE_BLK2_WDATA3_REG	[31:0]
		[159:128]	EFUSE_BLK2_WDATA4_REG	[31:0]
		[191:160]	EFUSE_BLK2_WDATA5_REG	[31:0]
		[223:192]	EFUSE_BLK2_WDATA6_REG	[31:0]
		[255:224]	EFUSE_BLK2_WDATA7_REG	[31:0]
BLOCK3	256/192/128	[31:0]	EFUSE_BLK3_WDATA0_REG	[31:0]
		[63:32]	EFUSE_BLK3_WDATA1_REG	[31:0]
		[95:64]	EFUSE_BLK3_WDATA2_REG	[31:0]
		[127:96]	EFUSE_BLK3_WDATA3_REG	[31:0]
		[159:128]	EFUSE_BLK3_WDATA4_REG	[31:0]
		[191:160]	EFUSE_BLK3_WDATA5_REG	[31:0]
		[223:192]	EFUSE_BLK3_WDATA6_REG	[31:0]
		[255:224]	EFUSE_BLK3_WDATA7_REG	[31:0]

The process of programming system parameters is as follows:

1. Configure EFUSE\_CLK\_SEL0 bit, EFUSE\_CLK\_SEL1 bit of register EFUSE\_CLK, and EFUSE\_DAC\_CLK\_DIV bit of register EFUSE\_DAC\_CONF.
2. Set the corresponding register bit of the system parameter bit to be programmed to 1.
3. Write 0x5A5A into register EFUSE\_CONF.
4. Write 0x2 into register EFUSE\_CMD.
5. Poll register EFUSE\_CMD until it is 0x0, or wait for a program-done interrupt.

6. Write 0x5AA5 into register EFUSE\_CONF.
7. Write 0x1 into register EFUSE\_CMD.
8. Poll register EFUSE\_CMD until it is 0x0, or wait for a read-done interrupt.
9. Set the corresponding register bit of the programmed bit to 0.

The configuration values of the EFUSE\_CLK\_SEL0 bit, EFUSE\_CLK\_SEL1 bit of register EFUSE\_CLK, and the EFUSE\_DAC\_CLK\_DIV bit of register EFUSE\_DAC\_CONF are based on the current APB\_CLK frequency, as is shown in Table 20-4.

**Table 20-4. Timing Configuration**

Register	Configuration Value	APB_CLK Frequency		
		26 MHz	40 MHz	80 MHz
EFUSE_CLK	EFUSE_CLK_SEL0[7:0]	250	160	80
	EFUSE_CLK_SEL1[7:0]	255	255	128
EFUSE_DAC_CONF	EFUSE_DAC_CLK_DIV[7:0]	52	80	100

The two methods to identify the generation of program/read-done interrupts are as follows:

Method One:

1. Poll bit 1/0 in register EFUSE\_INT\_RAW until bit 1/0 is 1, which represents the generation of an program/read-done interrupt.
2. Set the bit 1/0 in register EFUSE\_INT\_CLR to 1 to clear the program/read-done interrupts.

Method Two:

1. Set bit 1/0 in register EFUSE\_INT\_ENA to 1 to enable eFuse Controller to post a program/read-done interrupt.
2. Configure Interrupt Matrix to enable the CPU to respond to an EFUSE\_INT interrupt.
3. A program/read-done interrupt is generated.
4. Read bit 1/0 in register EFUSE\_INT\_ST to identify the generation of the program/read-done interrupt.
5. Set bit 1/0 in register EFUSE\_INT\_CLR to 1 to clear the program/read-done interrupt.

The programming of different system parameters and even the programming of different bits of the same system parameter can be completed separately in multiple programmings. It is, however, recommended that users minimize programming cycles, and program all the bits that need to be programmed in a system parameter in one programming action. In addition, after all system parameters controlled by a certain bit of efuse\_wr\_disable are programmed, that bit should be immediately programmed. The programming of system parameters controlled by a certain bit of efuse\_wr\_disable, and the programming of that bit can even be completed at the same time.

**Repeated programming of programmed bits is strictly forbidden.**

### 20.3.3 Software Reading of System Parameters

Each bit of the 30 fixed-length system parameters and the three variable-length system parameters corresponds to a software-read register bit, as shown in Table 20-5. Software can use the value of each system parameter by reading the value in the corresponding register.

The bit width of system parameters BLOCK1, BLOCK2, and BLOCK3 is variable. Although 256 register bits have been assigned to each of the three parameters, as shown in Table 20-5, some of the 256 register bits are useless

in the 3/4 coding and the Repeat coding scheme. In the None coding scheme, the corresponding register bit of each bit of *BLOCKN*[255 : 0] is used. In the 3/4 coding scheme, only the corresponding register bits of *BLOCKN*[191 : 0] are useful. In Repeat coding scheme, only the corresponding bits of *BLOCKN*[127 : 0] are useful. In different coding schemes, the values of useless register bits read by software are invalid. **The values of useful register bits read by software are the system parameters BLOCK1, BLOCK2, and BLOCK3 themselves instead of their values after being encoded.**

Table 20-5. Software Read Registers

System parameter			Register	
Name	Bit Width	Bit	Name	Bit
efuse_wr_disable	16	[15:0]	EFUSE_BLK0_RDATA0_REG	[15:0]
efuse_rd_disable	4	[3:0]		[19:16]
flash_crypt_cnt	7	[6:0]		[26:20]
uart_download_dis	1	[0]		[27]
WIFI_MAC_Address	56	[31:0]	EFUSE_BLK0_RDATA1_REG	[31:0]
		[55:32]	EFUSE_BLK0_RDATA2_REG	[23:0]
disable_app_cpu	1	[0]	EFUSE_BLK0_RDATA3_REG	[0]
disable_bt	1	[0]		[1]
pkg_version	4	[3:0]		[2], [11:9]
disable_cache	1	[0]		[3]
SPI_pad_config_hd	5	[4:0]		[8:4]
BLK3_part_reserve	1	[0]		[14]
CK8M Frequency	8	[7:0]		[7:0]
XPD_SDIO_REG	1	[0]	EFUSE_BLK0_RDATA4_REG	[14]
SDIO_TIEH	1	[0]		[15]
sdio_force	1	[0]		[16]
SPI_pad_config_clk	5	[4:0]	EFUSE_BLK0_RDATA5_REG	[4:0]
SPI_pad_config_q	5	[4:0]		[9:5]
SPI_pad_config_d	5	[4:0]		[14:10]
SPI_pad_config_cs0	5	[4:0]		[19:15]
vol_level_hp_inv	2	[1:0]		[23:22]
dig_vol_l6	4	[3:0]		[27:24]
flash_crypt_config	4	[3:0]		[31:28]
coding_scheme	2	[1:0]	EFUSE_BLK0_RDATA6_REG	[1:0]
console_debug_disable	1	[0]		[2]
abstract_done_0	1	[0]		[4]
abstract_done_1	1	[0]		[5]
JTAG_disable	1	[0]		[6]
download_dis_encrypt	1	[0]		[7]
download_dis_decrypt	1	[0]		[8]
download_dis_cache	1	[0]		[9]
key_status	1	[0]		[10]

System parameter			Register	
Name	Bit Width	Bit	Name	Bit
BLOCK1	256/192/128	[31:0]	EFUSE_BLK1_RDATA0_REG	[31:0]
		[63:32]	EFUSE_BLK1_RDATA1_REG	[31:0]
		[95:64]	EFUSE_BLK1_RDATA2_REG	[31:0]
		[127:96]	EFUSE_BLK1_RDATA3_REG	[31:0]
		[159:128]	EFUSE_BLK1_RDATA4_REG	[31:0]
		[191:160]	EFUSE_BLK1_RDATA5_REG	[31:0]
		[223:192]	EFUSE_BLK1_RDATA6_REG	[31:0]
		[255:224]	EFUSE_BLK1_RDATA7_REG	[31:0]
BLOCK2	256/192/128	[31:0]	EFUSE_BLK2_RDATA0_REG	[31:0]
		[63:32]	EFUSE_BLK2_RDATA1_REG	[31:0]
		[95:64]	EFUSE_BLK2_RDATA2_REG	[31:0]
		[127:96]	EFUSE_BLK2_RDATA3_REG	[31:0]
		[159:128]	EFUSE_BLK2_RDATA4_REG	[31:0]
		[191:160]	EFUSE_BLK2_RDATA5_REG	[31:0]
		[223:192]	EFUSE_BLK2_RDATA6_REG	[31:0]
		[255:224]	EFUSE_BLK2_RDATA7_REG	[31:0]
BLOCK3	256/192/128	[31:0]	EFUSE_BLK3_RDATA0_REG	[31:0]
		[63:32]	EFUSE_BLK3_RDATA1_REG	[31:0]
		[95:64]	EFUSE_BLK3_RDATA2_REG	[31:0]
		[127:96]	EFUSE_BLK3_RDATA3_REG	[31:0]
		[159:128]	EFUSE_BLK3_RDATA4_REG	[31:0]
		[191:160]	EFUSE_BLK3_RDATA5_REG	[31:0]
		[223:192]	EFUSE_BLK3_RDATA6_REG	[31:0]
		[255:224]	EFUSE_BLK3_RDATA7_REG	[31:0]

### 20.3.4 The Use of System Parameters by Hardware Modules

Hardware modules are directly hardwired to the ESP32 in order to use the system parameters. Software cannot change this behaviour. **Hardware modules use the decoded values of system parameters BLOCK1, BLOCK2, and BLOCK3, not their encoded values.**

### 20.3.5 Interrupts

- EFUSE\_PGM\_DONE\_INT: Triggered when eFuse programming has finished.
- EFUSE\_READ\_DONE\_INT: Triggered when eFuse reading has finished.

## 20.4 Register Summary

Name	Description	Address	Access
<b>eFuse data read registers</b>			
<a href="#">EFUSE_BLK0_RDATA0_REG</a>	Returns data word 0 in eFuse BLOCK 0	0x3FF5A000	RO
<a href="#">EFUSE_BLK0_RDATA1_REG</a>	Returns data word 1 in eFuse BLOCK 0	0x3FF5A004	RO
<a href="#">EFUSE_BLK0_RDATA2_REG</a>	Returns data word 2 in eFuse BLOCK 0	0x3FF5A008	RO
<a href="#">EFUSE_BLK0_RDATA3_REG</a>	Returns data word 3 in eFuse BLOCK 0	0x3FF5A00C	RO
<a href="#">EFUSE_BLK0_RDATA4_REG</a>	Returns data word 4 in eFuse BLOCK 0	0x3FF5A010	RO

Name	Description	Address	Access
EFUSE_BLK0_RDATA5_REG	Returns data word 5 in eFuse BLOCK 0	0x3FF5A014	RO
EFUSE_BLK0_RDATA6_REG	Returns data word 6 in eFuse BLOCK 0	0x3FF5A018	RO
EFUSE_BLK1_RDATA0_REG	Returns data word 0 in eFuse BLOCK 1	0x3FF5A038	RO
EFUSE_BLK1_RDATA1_REG	Returns data word 1 in eFuse BLOCK 1	0x3FF5A03C	RO
EFUSE_BLK1_RDATA2_REG	Returns data word 2 in eFuse BLOCK 1	0x3FF5A040	RO
EFUSE_BLK1_RDATA3_REG	Returns data word 3 in eFuse BLOCK 1	0x3FF5A044	RO
EFUSE_BLK1_RDATA4_REG	Returns data word 4 in eFuse BLOCK 1	0x3FF5A048	RO
EFUSE_BLK1_RDATA5_REG	Returns data word 5 in eFuse BLOCK 1	0x3FF5A04C	RO
EFUSE_BLK1_RDATA6_REG	Returns data word 6 in eFuse BLOCK 1	0x3FF5A050	RO
EFUSE_BLK1_RDATA7_REG	Returns data word 7 in eFuse BLOCK 1	0x3FF5A054	RO
EFUSE_BLK2_RDATA0_REG	Returns data word 0 in eFuse BLOCK 2	0x3FF5A058	RO
EFUSE_BLK2_RDATA1_REG	Returns data word 1 in eFuse BLOCK 2	0x3FF5A05C	RO
EFUSE_BLK2_RDATA2_REG	Returns data word 2 in eFuse BLOCK 2	0x3FF5A060	RO
EFUSE_BLK2_RDATA3_REG	Returns data word 3 in eFuse BLOCK 2	0x3FF5A064	RO
EFUSE_BLK2_RDATA4_REG	Returns data word 4 in eFuse BLOCK 2	0x3FF5A068	RO
EFUSE_BLK2_RDATA5_REG	Returns data word 5 in eFuse BLOCK 2	0x3FF5A06C	RO
EFUSE_BLK2_RDATA6_REG	Returns data word 6 in eFuse BLOCK 2	0x3FF5A070	RO
EFUSE_BLK2_RDATA7_REG	Returns data word 7 in eFuse BLOCK 2	0x3FF5A074	RO
EFUSE_BLK3_RDATA0_REG	Returns data word 0 in eFuse BLOCK 3	0x3FF5A078	RO
EFUSE_BLK3_RDATA1_REG	Returns data word 1 in eFuse BLOCK 3	0x3FF5A07C	RO
EFUSE_BLK3_RDATA2_REG	Returns data word 2 in eFuse BLOCK 3	0x3FF5A080	RO
EFUSE_BLK3_RDATA3_REG	Returns data word 3 in eFuse BLOCK 3	0x3FF5A084	RO
EFUSE_BLK3_RDATA4_REG	Returns data word 4 in eFuse BLOCK 3	0x3FF5A088	RO
EFUSE_BLK3_RDATA5_REG	Returns data word 5 in eFuse BLOCK 3	0x3FF5A08C	RO
EFUSE_BLK3_RDATA6_REG	Returns data word 6 in eFuse BLOCK 3	0x3FF5A090	RO
EFUSE_BLK3_RDATA7_REG	Returns data word 7 in eFuse BLOCK 3	0x3FF5A094	RO
<b>eFuse data write registers</b>			
EFUSE_BLK0_WDATA0_REG	Writes data to word 0 in eFuse BLOCK 0	0x3FF5A01c	R/W
EFUSE_BLK0_WDATA1_REG	Writes data to word 1 in eFuse BLOCK 0	0x3FF5A020	R/W
EFUSE_BLK0_WDATA2_REG	Writes data to word 2 in eFuse BLOCK 0	0x3FF5A024	R/W
EFUSE_BLK0_WDATA3_REG	Writes data to word 3 in eFuse BLOCK 0	0x3FF5A028	R/W
EFUSE_BLK0_WDATA4_REG	Writes data to word 4 in eFuse BLOCK 0	0x3FF5A02c	R/W
EFUSE_BLK0_WDATA5_REG	Writes data to word 5 in eFuse BLOCK 0	0x3FF5A030	R/W
EFUSE_BLK0_WDATA6_REG	Writes data to word 6 in eFuse BLOCK 0	0x3FF5A034	R/W
EFUSE_BLK1_WDATA0_REG	Writes data to word 0 in eFuse BLOCK 1	0x3FF5A098	R/W
EFUSE_BLK1_WDATA1_REG	Writes data to word 1 in eFuse BLOCK 1	0x3FF5A09c	R/W
EFUSE_BLK1_WDATA2_REG	Writes data to word 2 in eFuse BLOCK 1	0x3FF5A0a0	R/W
EFUSE_BLK1_WDATA3_REG	Writes data to word 3 in eFuse BLOCK 1	0x3FF5A0a4	R/W
EFUSE_BLK1_WDATA4_REG	Writes data to word 4 in eFuse BLOCK 1	0x3FF5A0a8	R/W
EFUSE_BLK1_WDATA5_REG	Writes data to word 5 in eFuse BLOCK 1	0x3FF5A0ac	R/W
EFUSE_BLK1_WDATA6_REG	Writes data to word 6 in eFuse BLOCK 1	0x3FF5A0b0	R/W
EFUSE_BLK1_WDATA7_REG	Writes data to word 7 in eFuse BLOCK 1	0x3FF5A0b4	R/W
EFUSE_BLK2_WDATA0_REG	Writes data to word 0 in eFuse BLOCK 2	0x3FF5A0b8	R/W

Name	Description	Address	Access
EFUSE_BLK2_WDATA1_REG	Writes data to word 1 in eFuse BLOCK 2	0x3FF5A0bc	R/W
EFUSE_BLK2_WDATA2_REG	Writes data to word 2 in eFuse BLOCK 2	0x3FF5A0c0	R/W
EFUSE_BLK2_WDATA3_REG	Writes data to word 3 in eFuse BLOCK 2	0x3FF5A0c4	R/W
EFUSE_BLK2_WDATA4_REG	Writes data to word 4 in eFuse BLOCK 2	0x3FF5A0c8	R/W
EFUSE_BLK2_WDATA5_REG	Writes data to word 5 in eFuse BLOCK 2	0x3FF5A0cc	R/W
EFUSE_BLK2_WDATA6_REG	Writes data to word 6 in eFuse BLOCK 2	0x3FF5A0d0	R/W
EFUSE_BLK2_WDATA7_REG	Writes data to word 7 in eFuse BLOCK 2	0x3FF5A0d4	R/W
EFUSE_BLK3_WDATA0_REG	Writes data to word 0 in eFuse BLOCK 3	0x3FF5A0d8	R/W
EFUSE_BLK3_WDATA1_REG	Writes data to word 1 in eFuse BLOCK 3	0x3FF5A0dc	R/W
EFUSE_BLK3_WDATA2_REG	Writes data to word 2 in eFuse BLOCK 3	0x3FF5A0e0	R/W
EFUSE_BLK3_WDATA3_REG	Writes data to word 3 in eFuse BLOCK 3	0x3FF5A0e4	R/W
EFUSE_BLK3_WDATA4_REG	Writes data to word 4 in eFuse BLOCK 3	0x3FF5A0e8	R/W
EFUSE_BLK3_WDATA5_REG	Writes data to word 5 in eFuse BLOCK 3	0x3FF5A0ec	R/W
EFUSE_BLK3_WDATA6_REG	Writes data to word 6 in eFuse BLOCK 3	0x3FF5A0f0	R/W
EFUSE_BLK3_WDATA7_REG	Writes data to word 7 in eFuse BLOCK 3	0x3FF5A0f4	R/W
<b>Control registers</b>			
EFUSE_CLK_REG	Timing configuration register	0x3FF5A0F8	R/W
EFUSE_CONF_REG	Opcode register	0x3FF5A0FC	R/W
EFUSE_CMD_REG	Read/write command register	0x3FF5A104	R/W
<b>Interrupt registers</b>			
EFUSE_INT_RAW_REG	Raw interrupt status	0x3FF5A108	RO
EFUSE_INT_ST_REG	Masked interrupt status	0x3FF5A10C	RO
EFUSE_INT_ENA_REG	Interrupt enable bits	0x3FF5A110	R/W
EFUSE_INT_CLR_REG	Interrupt clear bits	0x3FF5A114	WO
<b>Misc registers</b>			
EFUSE_DAC_CONF_REG	Efuse timing configuration	0x3FF5A118	R/W
EFUSE_DEC_STATUS_REG	Status of 3/4 coding scheme	0x3FF5A11C	RO

## 20.5 Registers

**Register 20.1. EFUSE\_BLK0\_RDATA0\_REG (0x000)**

<i>(reserved)</i>				<i>EFUSE_RD_UART_DOWNLOAD_DIS</i>				<i>EFUSE_RD_FLASH_CRYPT_CNT</i>				<i>EFUSE_RD_EFUSE_RD_DIS</i>				<i>EFUSE_RD_EFUSE_WR_DIS</i>															
31	28	27	26	25	24	23	22	21	20	19	18	17	16	15	14	13	12	11	10	9	8	7	6	5	4	3	2	1	0		
0	0	0	0	0	0	0	0	0	0	0	0	0	0	0	0	0	0	0	0	0	0	0	0	0	0	0	0	0	0	0	0

Reset

**EFUSE\_RD\_UART\_DOWNLOAD\_DIS** This bit returns the value of `uart_download_dis`. Valid only for ESP32. (RO)

**EFUSE\_RD\_FLASH\_CRYPT\_CNT** This field returns the value of `flash_crypt_cnt`. (RO)

**EFUSE\_RD\_EFUSE\_RD\_DIS** This field returns the value of `efuse_rd_disable`. (RO)

**EFUSE\_RD\_EFUSE\_WR\_DIS** This field returns the value of `efuse_wr_disable`. (RO)

**Register 20.2. EFUSE\_BLK0\_RDATA1\_REG (0x004)**

31	30	29	28	27	26	25	24	23	22	21	20	19	18	17	16	15	14	13	12	11	10	9	8	7	6	5	4	3	2	1	0	
0	0	0	0	0	0	0	0	0	0	0	0	0	0	0	0	0	0	0	0	0	0	0	0	0	0	0	0	0	0	0	0	0

Reset

**EFUSE\_BLK0\_RDATA1\_REG** This field returns the value of the lower 32 bits of `WIFI_MAC_Address`. (RO)

**Register 20.3. EFUSE\_BLK0\_RDATA2\_REG (0x008)**

<i>(reserved)</i>											<i>EFUSE_RD_WIFI_MAC_CRC_HIGH</i>																					
31	30	29	28	27	26	25	24	23	22	21	20	19	18	17	16	15	14	13	12	11	10	9	8	7	6	5	4	3	2	1	0	
0	0	0	0	0	0	0	0	0	0	0	0	0	0	0	0	0	0	0	0	0	0	0	0	0	0	0	0	0	0	0	0	0

Reset

**EFUSE\_RD\_WIFI\_MAC\_CRC\_HIGH** This field returns the value of the higher 24 bits of `WIFI_MAC_Address`. (RO)



## Register 20.4. EFUSE\_BLK0\_RDATA3\_REG (0x00c)

(reserved)												EFUSE_RD_CHIP_VER_PKG			EFUSE_RD_SPI_PAD_CONFIG_HD			EFUSE_RD_CHIP_VER_DIS_CACHE			EFUSE_RD_CHIP_VER_PKG			EFUSE_RD_CHIP_VER_DIS_BT			EFUSE_RD_CHIP_VER_DIS_APP_CPU		
31												12	11	9	8				4	3	2	1	0						
0 0 0 0 0 0 0 0 0 0 0 0												0 0 0			0 0 0			0 0 0			0 0 0			0 0 0			Reset		

**EFUSE\_RD\_CHIP\_VER\_PKG** These are the first three identification bits of chip packaging version among the four identification bits. (RO)

**EFUSE\_RD\_SPI\_PAD\_CONFIG\_HD** This field returns the value of SPI\_pad\_config\_hd. (RO)

**EFUSE\_RD\_CHIP\_VER\_DIS\_CACHE** Disables cache. (RO)

**EFUSE\_RD\_CHIP\_VER\_PKG** This is the fourth identification bit of chip packaging version among the four identification bits. (RO)

**EFUSE\_RD\_CHIP\_VER\_DIS\_BT** Disables Bluetooth. (RO)

**EFUSE\_RD\_CHIP\_VER\_DIS\_APP\_CPU** Disables APP CPU. (RO)

## Register 20.5. EFUSE\_BLK0\_RDATA4\_REG (0x010)

(reserved)												EFUSE_RD_SDIO_FORCE			EFUSE_RD_SDIO_TIEH			EFUSE_RD_XPD_SDIO			(reserved)						ESFUSE_RD_CK8M_FREQ							
31												17	16	15	14	13				8	7							0						
0 0 0 0 0 0 0 0 0 0 0 0												0 0 0			0 0 0			0 0 0			0 0 0			0 0 0			0 0 0			0 0 0			Reset	

**EFUSE\_RD\_SDIO\_FORCE** This field returns the value of sdio\_force. (RO)

**EFUSE\_RD\_SDIO\_TIEH** This field returns the value of SDIO\_TIEH. (RO)

**EFUSE\_RD\_XPD\_SDIO** This field returns the value of XPD\_SDIO\_REG. (RO)

**ESFUSE\_RD\_CK8M\_FREQ** RTC8M\_CLK frequency. (RO)

Register 20.6. EFUSE\_BLK0\_RDATA5\_REG (0x014)

EFUSE_RD_FLASH_CRYPT_CONFIG				EFUSE_RD_DIG_VOL_L6				EFUSE_RD_VOL_LEVEL_HP_INV (reserved)				EFUSE_RD_SPI_PAD_CONFIG_CS0				EFUSE_RD_SPI_PAD_CONFIG_D				EFUSE_RD_SPI_PAD_CONFIG_Q				EFUSE_RD_SPI_PAD_CONFIG_CLK					
31	28	27	24	23	22	21	20	19	15	14	10	9	5	4	0														
0	0	0	0	0	0	0	0	0	0	0	0	0	0	0	0	Reset													

**EFUSE\_RD\_FLASH\_CRYPT\_CONFIG** This field returns the value of flash\_crypt\_config. (RO)

**EFUSE\_RD\_DIG\_VOL\_L6** This field stores the difference between the digital regulator voltage at level 6 and 1.2 V. (RO)

**EFUSE\_RD\_VOL\_LEVEL\_HP\_INV** This field stores the voltage level for CPU to run at 240 MHz, or for flash/PSRAM to run at 80 MHz. 0x0: level 7; 0x1: level 6; 0x2: level 5; 0x3: level 4. (RO)

**EFUSE\_RD\_SPI\_PAD\_CONFIG\_CS0** This field returns the value of SPI\_pad\_config\_cs0. (RO)

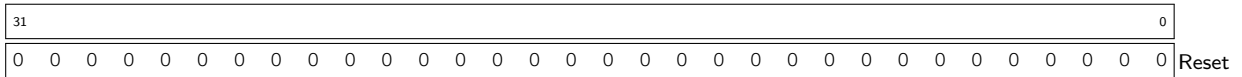
**EFUSE\_RD\_SPI\_PAD\_CONFIG\_D** This field returns the value of SPI\_pad\_config\_d. (RO)

**EFUSE\_RD\_SPI\_PAD\_CONFIG\_Q** This field returns the value of SPI\_pad\_config\_q. (RO)

**EFUSE\_RD\_SPI\_PAD\_CONFIG\_CLK** This field returns the value of SPI\_pad\_config\_clk. (RO)

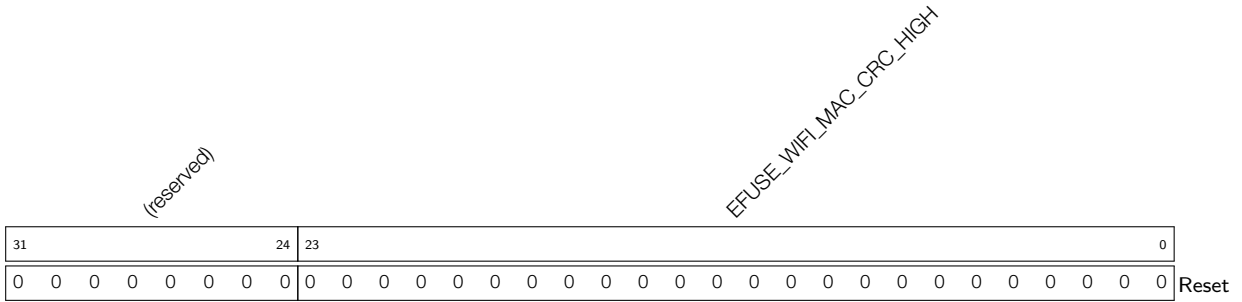


**Register 20.9. EFUSE\_BLK0\_WDATA1\_REG (0x020)**



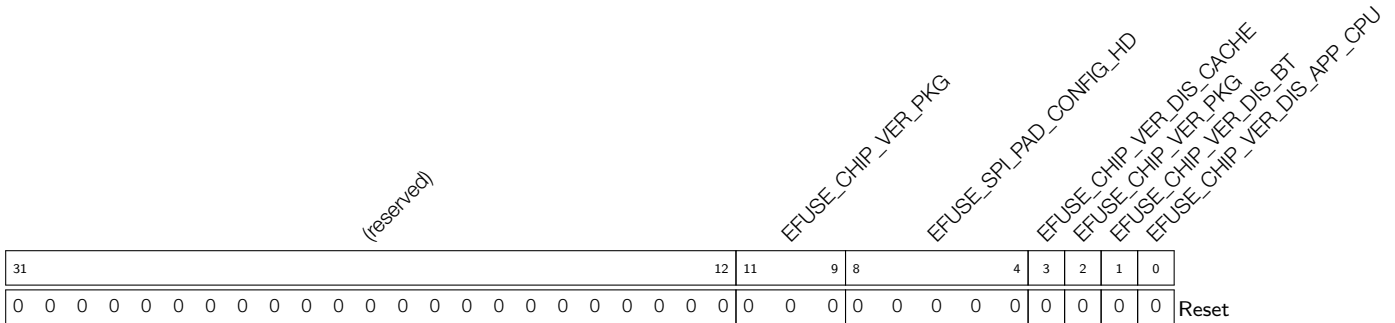
**EFUSE\_BLK0\_WDATA1\_REG** This field programs the value of lower 32 bits of WIFI\_MAC\_Address. (R/W)

**Register 20.10. EFUSE\_BLK0\_WDATA2\_REG (0x024)**



**EFUSE\_WIFI\_MAC\_CRC\_HIGH** This field programs the value of higher 24 bits of WIFI\_MAC\_Address. (R/W)

**Register 20.11. EFUSE\_BLK0\_WDATA3\_REG (0x028)**



**EFUSE\_CHIP\_VER\_PKG** These are the first three bits among the four bits to program chip packaging version. (R/W)

**EFUSE\_SPI\_PAD\_CONFIG\_HD** This field programs the value of SPI\_pad\_config\_hd. (R/W)

**EFUSE\_CHIP\_VER\_DIS\_CACHE** This field is programmed to disable cache. (R/W)

**EFUSE\_CHIP\_VER\_PKG** This is the fourth bit among the four bits to program chip packaging version. (R/W)

**EFUSE\_CHIP\_VER\_DIS\_BT** This field is programmed to disable Bluetooth. (R/W)

**EFUSE\_CHIP\_VER\_DIS\_APP\_CPU** This field is programmed to disable APP CPU. (R/W)

**Register 20.12. EFUSE\_BLK0\_WDATA4\_REG (0x02c)**

<i>(reserved)</i>															<i>EFUSE_SDIO_FORCE</i>				<i>EFUSE_SDIO_TIEH</i>				<i>EFUSE_XPD_SDIO</i>				<i>(reserved)</i>						<i>EFUSE_CK8M_FREQ</i>					
31															17	16	15	14	13						8	7							0					
0	0	0	0	0	0	0	0	0	0	0	0	0	0	0	0	0	0	0	0	0	0	0	0	0	0	0	0	0	0	0	0	0	0	0				

Reset

- EFUSE\_SDIO\_FORCE** This field programs the value of SDIO\_TIEH. (R/W)
- EFUSE\_SDIO\_TIEH** This field programs the value of SDIO\_TIEH. (R/W)
- EFUSE\_XPD\_SDIO** This field programs the value of XPD\_SDIO\_REG. (R/W)
- ESFUSE\_CK8M\_FREQ** This field programs the frequency of RTC8M\_CLK. (R/W)

**Register 20.13. EFUSE\_BLK0\_WDATA5\_REG (0x030)**

<i>EFUSE_FLASH_CRYPT_CONFIG</i>										<i>EFUSE_DIG_VOL_L6</i>					<i>EFUSE_VOL_LEVEL_HP_INV</i>				<i>(reserved)</i>					<i>EFUSE_SPL_PAD_CONFIG_CS0</i>					<i>EFUSE_SPL_PAD_CONFIG_D</i>					<i>EFUSE_SPL_PAD_CONFIG_Q</i>					<i>EFUSE_SPL_PAD_CONFIG_CLK</i>				
31										28	27	24	23	22	21	20				15	14				10	9				5	4				0								
0	0	0	0	0	0	0	0	0	0	0	0	0	0	0	0	0	0	0	0	0	0	0	0	0	0	0	0	0	0	0	0	0	0	0	0	0							

Reset

- EFUSE\_FLASH\_CRYPT\_CONFIG** This field programs the value of flash\_crypt\_config. (R/W)
- EFUSE\_DIG\_VOL\_L6** This field stores the difference between the digital regulator voltage at level 6 and 1.2 V. (R/W)
- EFUSE\_VOL\_LEVEL\_HP\_INV** These bits store the voltage level for CPU to run at 240 MHz, or for flash/PSRAM to run at 80 MHz. 0x0: level 7; 0x1: level 6; 0x2: level 5; 0x3: level 4. (R/W)
- EFUSE\_SPL\_PAD\_CONFIG\_CS0** This field programs the value of SPI\_pad\_config\_cs0. (R/W)
- EFUSE\_SPL\_PAD\_CONFIG\_D** This field programs the value of SPI\_pad\_config\_d. (R/W)
- EFUSE\_SPL\_PAD\_CONFIG\_Q** This field programs the value of SPI\_pad\_config\_q. (R/W)
- EFUSE\_SPL\_PAD\_CONFIG\_CLK** This field programs the value of SPI\_pad\_config\_clk. (R/W)

## Register 20.14. EFUSE\_BLK0\_WDATA6\_REG (0x034)

(reserved)											EFUSE_KEY_STATUS EFUSE_DISABLE_DL_CACHE EFUSE_DISABLE_DL_DECRYPT EFUSE_DISABLE_DL_ENCRYPT EFUSE_DISABLE_JTAG EFUSE_ABS_DONE_1 (reserved) EFUSE_ABS_DONE_0 EFUSE_CONSOLE_DEBUG_DISABLE EFUSE_CODING_SCHEME											
31											11	10	9	8	7	6	5	4	3	2	1	0
0											0										Reset	

**EFUSE\_KEY\_STATUS** This field programs the value of key\_status. (R/W)

**EFUSE\_DISABLE\_DL\_CACHE** This field programs the value of download\_dis\_cache. (R/W)

**EFUSE\_DISABLE\_DL\_DECRYPT** This field programs the value of download\_dis\_decrypt. (R/W)

**EFUSE\_DISABLE\_DL\_ENCRYPT** This field programs the value of download\_dis\_encrypt. (R/W)

**EFUSE\_DISABLE\_JTAG** This field programs the value of JTAG\_disable. (R/W)

**EFUSE\_ABS\_DONE\_1** This field programs the value of abstract\_done\_1. (R/W)

**EFUSE\_ABS\_DONE\_0** This field programs the value of abstract\_done\_0. (R/W)

**EFUSE\_CONSOLE\_DEBUG\_DISABLE** This field programs the value of console\_debug\_disable. (R/W)

**EFUSE\_CODING\_SCHEME** This field programs the value of coding\_scheme. (R/W)

Register 20.15. EFUSE\_BLK1\_RDATA<sub>*n*</sub>\_REG (*n*: 0-7) (0x38+4\**n*)

31																															0	
0x00000000																																Reset

**EFUSE\_BLK1\_RDATA<sub>*n*</sub>\_REG** This field returns the value of word *n* in BLOCK1. (RO)

Register 20.16. EFUSE\_BLK2\_RDATA<sub>*n*</sub>\_REG (*n*: 0-7) (0x58+4\**n*)

31																															0	
0x00000000																																Reset

**EFUSE\_BLK2\_RDATA<sub>*n*</sub>\_REG** This field returns the value of word *n* in BLOCK2. (RO)

**Register 20.17. EFUSE\_BLK3\_RDATA<sub>*n*</sub>\_REG (*n*: 0-7) (0x78+4\**n*)**

31	0
0x00000000	

Reset

**EFUSE\_BLK3\_RDATA<sub>*n*</sub>\_REG** This field returns the value of word *n* in BLOCK3. (RO)

**Register 20.18. EFUSE\_BLK1\_WDATA<sub>*n*</sub>\_REG (*n*: 0-7) (0x98+4\**n*)**

31	0
0x00000000	

Reset

**EFUSE\_BLK1\_WDATA<sub>*n*</sub>\_REG** This field programs the value of word *n* in of BLOCK1. (R/W)

**Register 20.19. EFUSE\_BLK2\_WDATA<sub>*n*</sub>\_REG (*n*: 0-7) (0xB8+4\**n*)**

31	0
0x00000000	

Reset

**EFUSE\_BLK2\_WDATA<sub>*n*</sub>\_REG** This field programs the value of word *n* in of BLOCK2. (R/W)

**Register 20.20. EFUSE\_BLK3\_WDATA<sub>*n*</sub>\_REG (*n*: 0-7) (0xD8+4\**n*)**

31	0
0x00000000	

Reset

**EFUSE\_BLK3\_WDATA<sub>*n*</sub>\_REG** This field programs the value of word *n* in of BLOCK3. (R/W)

**Register 20.21. EFUSE\_CLK\_REG (0x0f8)**

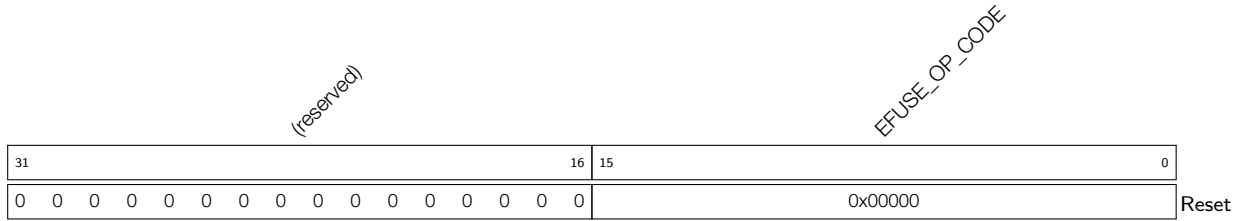
31	16	15	8	7	0
<div style="display: flex; justify-content: space-between; width: 100%;"> <span>(reserved)</span> <span>EFUSE_CLK_SEL1</span> <span>EFUSE_CLK_SELO</span> </div>					
0 0 0 0 0 0 0 0 0 0 0 0 0 0 0 0					
0x040				0x052	

Reset

**EFUSE\_CLK\_SEL1** eFuse clock configuration field. (R/W)

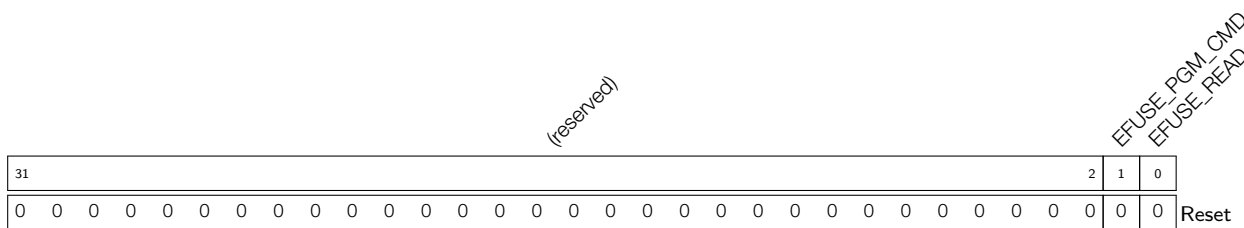
**EFUSE\_CLK\_SELO** eFuse clock configuration field. (R/W)

**Register 20.22. EFUSE\_CONF\_REG (0x0fc)**



**EFUSE\_OP\_CODE** eFuse operation code register. (R/W)

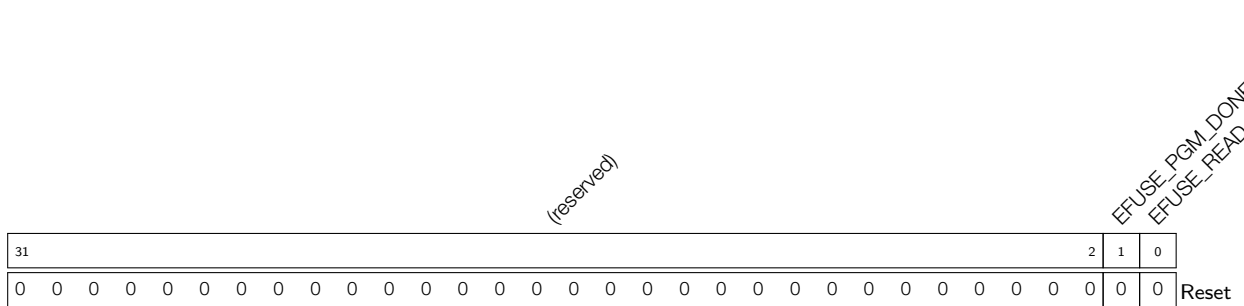
**Register 20.23. EFUSE\_CMD\_REG (0x104)**



**EFUSE\_PGM\_CMD** Set this to 1 to start a program operation. Reverts to 0 when the program operation is done. (R/W)

**EFUSE\_READ\_CMD** Set this to 1 to start a read operation. Reverts to 0 when the read operation is done. (R/W)

**Register 20.24. EFUSE\_INT\_RAW\_REG (0x108)**

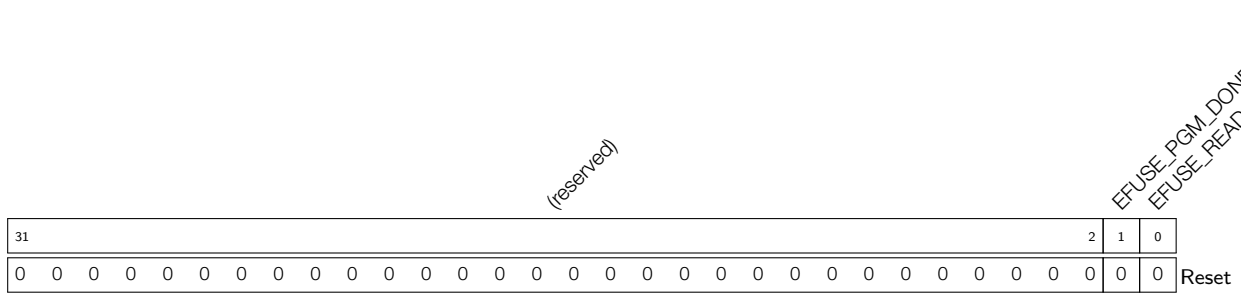


**EFUSE\_PGM\_DONE\_INT\_RAW** The raw interrupt status bit for the [EFUSE\\_PGM\\_DONE\\_INT](#) interrupt. (RO)

**EFUSE\_READ\_DONE\_INT\_RAW** The raw interrupt status bit for the [EFUSE\\_READ\\_DONE\\_INT](#) interrupt. (RO)



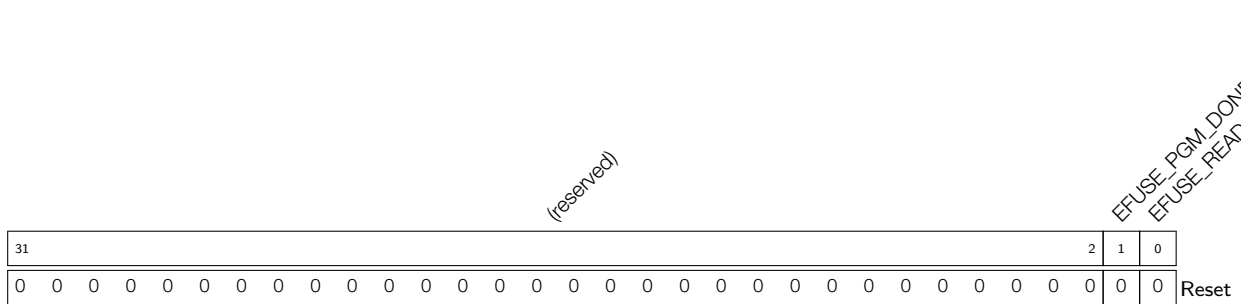
## Register 20.25. EFUSE\_INT\_ST\_REG (0x10c)



**EFUSE\_PGM\_DONE\_INT\_ST** The masked interrupt status bit for the [EFUSE\\_PGM\\_DONE\\_INT](#) interrupt. (RO)

**EFUSE\_READ\_DONE\_INT\_ST** The masked interrupt status bit for the [EFUSE\\_READ\\_DONE\\_INT](#) interrupt. (RO)

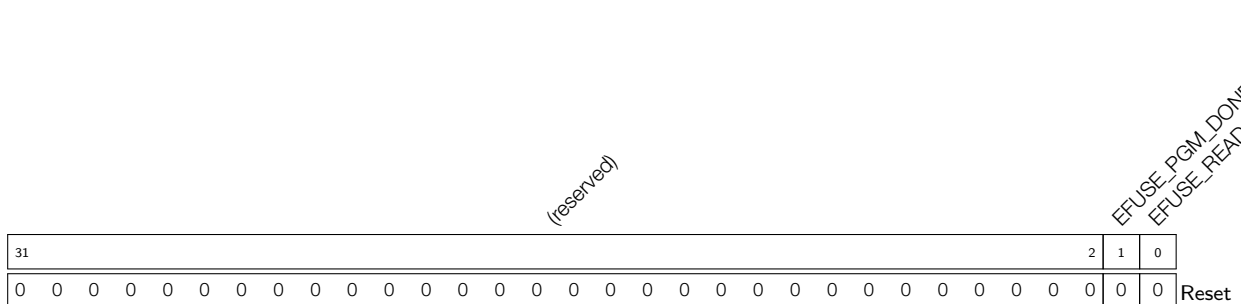
## Register 20.26. EFUSE\_INT\_ENA\_REG (0x110)



**EFUSE\_PGM\_DONE\_INT\_ENA** The interrupt enable bit for the [EFUSE\\_PGM\\_DONE\\_INT](#) interrupt. (R/W)

**EFUSE\_READ\_DONE\_INT\_ENA** The interrupt enable bit for the [EFUSE\\_READ\\_DONE\\_INT](#) interrupt. (R/W)

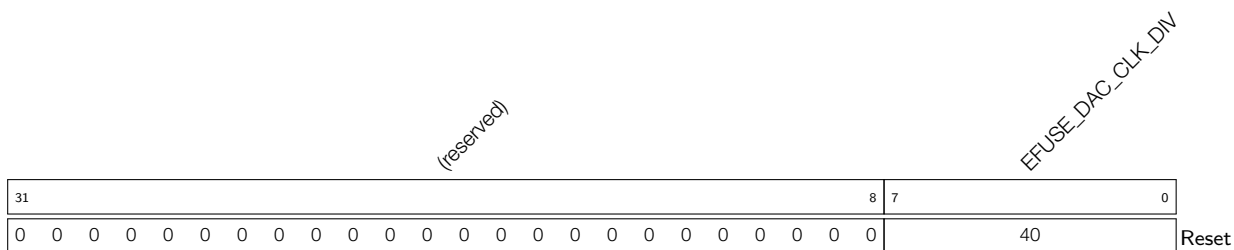
## Register 20.27. EFUSE\_INT\_CLR\_REG (0x114)



**EFUSE\_PGM\_DONE\_INT\_CLR** Set this bit to clear the [EFUSE\\_PGM\\_DONE\\_INT](#) interrupt. (WO)

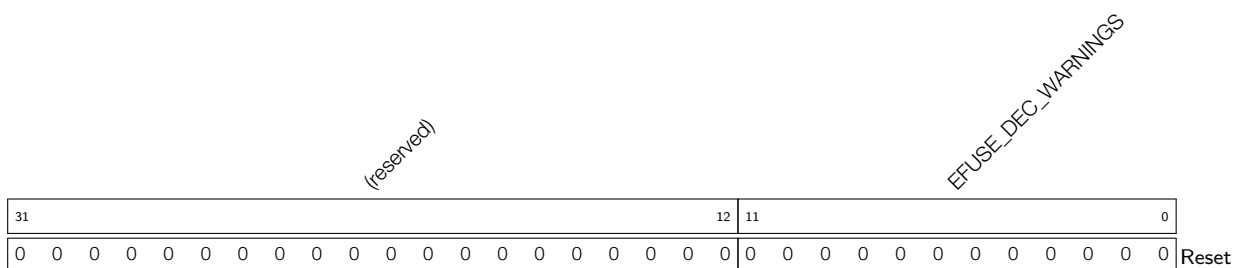
**EFUSE\_READ\_DONE\_INT\_CLR** Set this bit to clear the [EFUSE\\_READ\\_DONE\\_INT](#) interrupt. (WO)

**Register 20.28. EFUSE\_DAC\_CONF\_REG (0x118)**



**EFUSE\_DAC\_CLK\_DIV** eFuse timing configuration register. (R/W)

**Register 20.29. EFUSE\_DEC\_STATUS\_REG (0x11c)**



**EFUSE\_DEC\_WARNINGS** If a bit is set in this register, it means some errors were corrected while decoding the 3/4 encoding scheme. (RO)

## 21 Two-wire Automotive Interface (TWAI)

### 21.1 Overview

The Two-wire Automotive Interface (TWAI<sup>®</sup>) is a multi-master, multi-cast communication protocol with error detection and signaling and inbuilt message priorities and arbitration. The TWAI protocol is suited for automotive and industrial applications (Please see [TWAI Protocol Description](#)).

ESP32 contains a TWAI controller that can be connected to a TWAI bus via an external transceiver. The TWAI controller contains numerous advanced features, and can be utilized in a wide range of use cases such as automotive products, industrial automation controls, building automation etc.

### 21.2 Features

ESP32 TWAI controller supports the following features:

- compatible with ISO 11898-1 protocol (CAN Specification 2.0)
- Supports Standard Frame Format (11-bit ID) and Extended Frame Format (29-bit ID)
- Bit rates from 25 Kbit/s to 1 Mbit/s
- Multiple modes of operation
  - Normal
  - Listen Only (no influence on bus)
  - Self Test (transmissions do not require acknowledgment)
- 64-byte Receive FIFO
- Special transmissions
  - Single-shot transmissions (does not automatically re-transmit upon error)
  - Self Reception (the TWAI controller transmits and receives messages simultaneously)
- Acceptance Filter (supports single and dual filter modes)
- Error detection and handling
  - Error counters
  - Configurable Error Warning Limit
  - Error Code Capture
  - Arbitration Lost Capture

### 21.3 Functional Protocol

#### 21.3.1 TWAI Properties

The TWAI protocol connects two or more nodes in a bus network, and allows for nodes to exchange messages in a latency bounded manner. A TWAI bus will have the following properties.

**Single Channel and Non-Return-to-Zero:** The bus consists of a single channel to carry bits, thus communication is half-duplex. Synchronization is also derived from this channel, thus extra channels (e.g., clock or enable) are not required. The bit stream of a TWAI message is encoded using the Non-Return-to-Zero (NRZ) method.

**Bit Values:** The single channel can either be in a Dominant or Recessive state, representing a logical 0 and a logical 1 respectively. A node transmitting a Dominant state will always override a another node transmitting a Recessive state. The physical implementation on the bus is left to the application level to decide (e.g., differential wiring).

**Bit-Stuffing:** Certain fields of TWAI messages are bit-stuffed. A Transmitter that transmits five consecutive bits of the same value should automatically insert a complementary bit. Likewise, a Receiver that receives five consecutive bits should treat the next bit as a stuff bit. Bit stuffing is applied to the following fields: SOF, Arbitration Field, Control Field, Data Field, and CRC Sequence (see Section 21.3.2 for more details).

**Multi-cast:** All nodes receive the same bits as they are connected to the same bus. Data is consistent across all nodes unless there is a bus error (See Section 21.3.3).

**Multi-master:** Any node can initiate a transmission. If a transmission is already ongoing, a node will wait until the current transmission is over before beginning its own transmission.

**Message-Priorities and Arbitration:** If two or more nodes simultaneously initiate a transmission, the TWAI protocol ensures that one node will win arbitration of the bus. The Arbitration Field of the message transmitted by each node is used to determine which node will win arbitration.

**Error Detection and Signaling:** Each node will actively monitor the bus for errors, and signal the detection errors by transmitting an Error Frame.

**Fault Confinement:** Each node will maintain a set of error counts that are incremented/decremented according to a set of rules. When the error counts surpass a certain threshold, a node will automatically eliminate itself from the network by switching itself off.

**Configurable Bit Rate:** The bit rate for a single TWAI bus is configurable. However, all nodes within the same bus must operate at the same bit rate.

**Transmitters and Receivers:** At any point in time, a TWAI node can either be a Transmitter or a Receiver.

- A node originating a message is a Transmitter. The node remains a Transmitter until the bus is idle or until the node loses arbitration. Note that multiple nodes can be Transmitter if they have yet to lose arbitration.
- All nodes that are not Transmitters are Receivers.

### 21.3.2 TWAI Messages

TWAI nodes use messages to transmit data, and signal errors to other nodes. Messages are split into various frame types, and some frame types will have different frame formats. The TWAI protocol has of the following frame types:

- Data Frames
- Remote Frames
- Error Frames
- Overload Frames
- Interframe Space

The TWAI protocol has the following frame formats:

- Standard Frame Format (SFF) that consists of a 11-bit identifier
- Extended Frame Format (EFF) that consists of a 29-bit identifier

### 21.3.2.1 Data Frames and Remote Frames

Data Frames are used by nodes to send data to other nodes, and can have a payload of 0 to 8 data bytes. Remote Frames are used to nodes to request a Data Frame with the same Identifier from another node, thus does not contain any data bytes. However, Data Frames and Remote Frames share many common fields. Figure 21-1 illustrates the fields and sub fields of the different frames and formats.

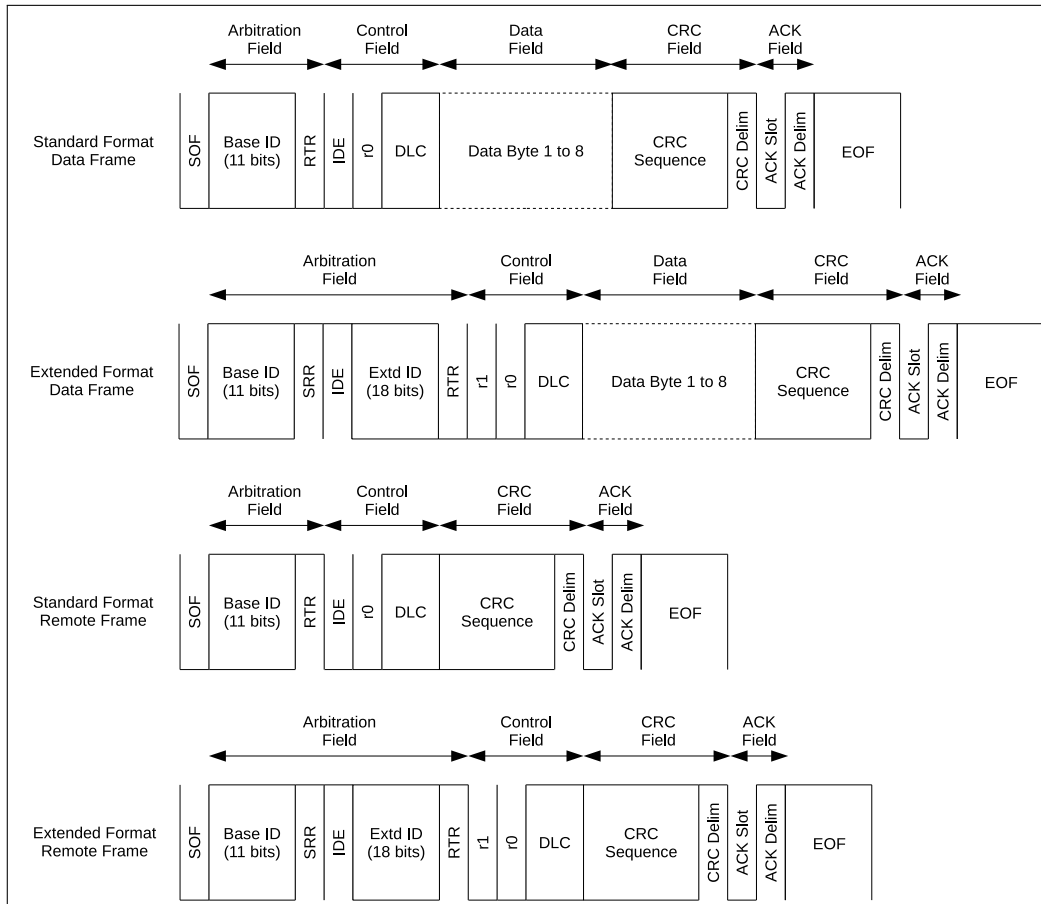


Figure 21-1. The bit fields of Data Frames and Remote Frames

#### Arbitration Field

When two or more nodes transmit a Data or Remote Frame simultaneously, the Arbitration Field is used to determine which node will win arbitration of the bus. During the Arbitration Field, if a node transmits a Recessive bit but observes a Dominant bit, this indicates that another node has overridden its Recessive bit. Therefore, the node transmitting the Recessive bit has lost arbitration of the bus and should immediately become a Receiver.

The Arbitration Field primarily consists of the Frame Identifier that is transmitted most significant bit first. Given that a Dominant bit represents a logical 0, and a Recessive bit represents a logical 1:

- A frame with the smallest ID value will always win arbitration.
- Given the same ID and format, Data Frames will always prevail over RTR Frames.
- Given the same first 11 bits of ID, a Standard Format Data Frame will prevail over an Extended Format Data Frame due to the SRR being recessive.

#### Control Field

The control field primarily consists of the DLC (Data Length Code) which indicates the number of payload data bytes for a Data Frame, or the number of requested data bytes for a Remote Frame. The DLC is transmitted most significant bit first.

### Data Field

The Data Field contains the actual payload data bytes of a Data Frame. Remote Frames do not contain a Data Field.

### CRC Field

The CRC Field primarily consists of a CRC Sequence. The CRC Sequence is a 15-bit cyclic redundancy code calculated from the de-stuffed contents (everything from the SOF to the end of the Data Field) of a Data or Remote Frame.

### ACK Field

The ACK Field primarily consists of an ACK Slot and an ACK Delim. The ACK Field is mainly intended for the receiver to send a message to a transmitter, indicating it has received an effective message.

**Table 21-1. Data Frames and Remote Frames in SFF and EFF**

Data/Remote Frames	Description
SOF	The SOF (Start of Frame) is a single Dominant bit used to synchronize nodes on the bus.
Base ID	The Base ID (ID.28 to ID.18) is the 11-bit Identifier for SFF, or the first 11-bits of the 29-bit Identifier for EFF.
RTR	The RTR (Remote Transmission Request) bit indicates whether the message is a Data Frame (Dominant) or a Remote Frame (Recessive). This means that a Remote Frame will always lose arbitration to a Data Frame given they have the same ID.
SRR	The SRR (Substitute Remote Request) bit is transmitted in EFF to substitute for the RTR bit at the same position in SFF.
IDE	The IDE (Identifier Extension) bit indicates whether the message is SFF (Dominant) or EFF (Recessive). This means that a SFF frame will always win arbitration over an EFF frame given they have the same Base ID.
Extd ID	The Extended ID (ID.17 to ID.0) is the remaining 18-bits of the 29-bit identifier for EFF.
r1	The r1 (reserved bit 1) is always Dominant.
r0	The r0 (reserved bit 0) is always Dominant.
DLC	The DLC (Data Length Code) is 4-bits and should have a value from 0 to 8. Data Frames use the DLC to indicate the number data bytes in the Data Frame. Remote Frames used the DLC to indicate the number of data bytes to request from another node.
Data Bytes	The data payload of Data Frames. The number of bytes should match the value of DLC. Data byte 0 is transmitted first, and each data byte is transmitted most significant bit first.

Data/Remote Frames	Description
CRC Sequence	The CRC sequence is a 15-bit cyclic redundancy code.
CRC Delim	The CRC Delim (CRC Delimiter) is a single Recessive bit that follows the CRC sequence.
ACK Slot	The ACK Slot (Acknowledgment Slot) that intended for Receiver nodes to indicate that the Data or Remote Frame was received without issue. The Transmitter node will send a Recessive bit in the ACK Slot and Receiver nodes should override the ACK Slot with a Dominant bit if the frame was received without errors.
ACK Delim	The ACK Delim (Acknowledgment Delimiter) is a single Recessive bit.
EOF	The EOF (End of Frame) marks the end of a Data or Remote Frame, and consists of seven Recessive bits.

### 21.3.2.2 Error and Overload Frames

#### Error Frames

Error Frames are transmitted when a node detects a Bus Error. Error Frames notably consist of an Error Flag which is made up of 6 consecutive bits of the same value, thus violating the bit-stuffing rule. Therefore, when a particular node detects a Bus Error and transmits an Error Frame, all other nodes will then detect a Stuff Error and transmit their own Error Frames in response. This has the effect of propagating the detection of a Bus Error across all nodes on the bus. When a node detects a Bus Error, it will transmit an Error Frame starting on the next bit. However, if the type of Bus Error was a CRC Error, then the Error Frame will start at the bit following the ACK Delim (see Section 21.3.3). The following Figure 21-2 shows the various fields of an Error Frame:

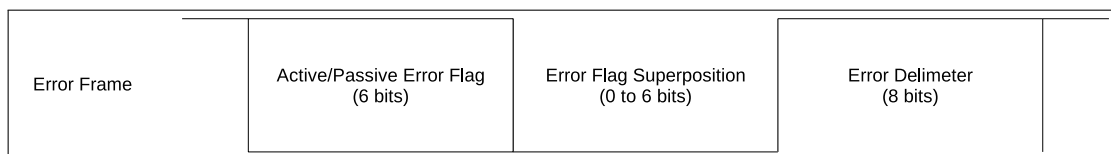


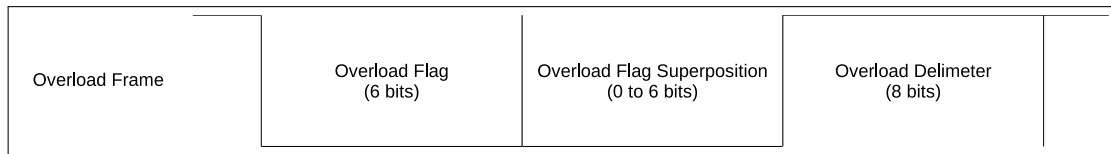
Figure 21-2. Various Fields of an Error Frame

Table 21-2. Error Frame

Error Frame	Description
Error Flag	The Error Flag has two forms, the Active Error Flag consisting of 6 Dominant bits and the Passive Error Flag consisting of 6 Recessive bits (unless overridden by Dominant bits of other nodes). Active Error Flags are sent by Error Active nodes, whilst Passive Error Flags are sent by Error Passive nodes.
Error Flag Superposition	The Error Flag Superposition field meant to allow for other nodes on the bus to transmit their respective Active Error Flags. The superposition field can range from 0 to 6 bits, and ends when the first Recessive bit is detected (i.e., the first bit of the Delimiter).
Error Delimiter	The Delimiter field marks the end of the Error/Overload Frame, and consists of 8 Recessive bits.

#### Overload Frames

An Overload Frame has the same bit fields as an Error Frame containing an Active Error Flag. The key difference is in the conditions that can trigger the transmission of an Overload Frame. Figure 21-3 below shows the bit fields of an Overload Frame.



**Figure 21-3. The Bit Fields of an Overload Frame**

**Table 21-3. Overload Frame**

Overload Frame	Description
Overload Flag	Consists of 6 Dominant bits. Same as an Active Error Flag.
Overload Flag Superposition	Allows for the superposition of Overload Flags from other nodes, similar to an Error Flag Superposition.
Overload Delimeter	Consists of 8 Recessive. Same as an Error Delimeter.

Overload Frames will be transmitted under the following conditions:

1. The internal conditions of a Receiver requires a delay of the next Data or Remote Frame.
2. Detection of a Dominant bit at the first and second bit of Intermission.
3. If a Dominant bit is detected at the eighth (last) bit of an Error Delimeter. Note that in this case, TEC and REC will not be incremented (See Section 21.3.3).

Transmitting an overload frame due to one of the conditions must also satisfy the following rules:

- Transmitting an Overload Frame due to condition 1 must only be started at the first bit of Intermission.
- Transmitting an Overload Frame due to condition 2 and 3 must start one bit after the detecting the Dominant bit of the condition.
- A maximum of two Overload frames may be generated in order to delay the next Data or Remote Frame.

### 21.3.2.3 Interframe Space

The Interframe Space acts as a separator between frames. Data Frames and Remote Frames must be separated from preceding frames by an Interframe Space, regardless of the preceding frame's type (Data Frame, Remote Frame, Error Frame, Overload Frame). However, Error Frames and Overload Frames do not need to be separated from preceding frames.

Figure 21-4 shows the fields within an Interframe Space:

**Table 21-4. Interframe Space**

Interframe Space	Description
Intermission	The Intermission consists of 3 Recessive bits.



Interframe Space	Description
Suspend Transmission	An Error Passive node that has just transmitted a message must include a Suspend Transmission field. This field consists of 8 Recessive bits. Error Active nodes should not include this field.
Bus Idle	The Bus Idle field is of arbitrary length. Bus Idle ends when an SOF is transmitted. If a node has a pending transmission, the SOF should be transmitted at the first bit following Intermission.

### 21.3.3 TWAI Errors

#### 21.3.3.1 Error Types

Bus Errors in TWAI are categorized into one of the following types:

##### Bit Error

A Bit Error occurs when a node transmits a bit value (i.e., Dominant or Recessive) but the opposite bit is detected (e.g., a Dominant bit is transmitted but a Recessive is detected). However, if the transmitted bit is Recessive and is located in the Arbitration Field or ACK Slot or Passive Error Flag, then detecting a Dominant bit will not be considered a Bit Error.

##### Stuff Error

A stuff error is detected when 6 consecutive bits of the same value are detected (thus violating the bit-stuffing encoding).

##### CRC Error

A Receiver of a Data or Remote Frame will calculate a CRC based on the bits it has received. A CRC error occurs when the CRC calculated by the Receiver does not match the CRC sequence in the received Data or Remote Frame.

##### Form Error

A Form Error is detected when a fixed-form bit field of a message contains an illegal bit. For example, the r1 and r0 fields must be Dominant.

##### Acknowledgement Error

An Acknowledgement Error occurs when a Transmitter does not detect a Dominant bit at the ACK Slot.

#### 21.3.3.2 Error States

TWAI nodes implement fault confinement by each maintaining two error counters, where the counter values determine the error state. The two error counters are known as the Transmit Error Counter (TEC) and Receive Error Counter (REC). TWAI has the following error states.

##### Error Active

An Error Active node is able to participate in bus communication and transmit an Active Error Flag when it detects an error.

##### Error Passive

An Error Passive node is able to participate in bus communication, but can only transmit an Passive Error Flag when it detects an error. Error Passive nodes that have transmitted a Data or Remote Frame must also include the Suspend Transmission field in the subsequent Interframe Space.

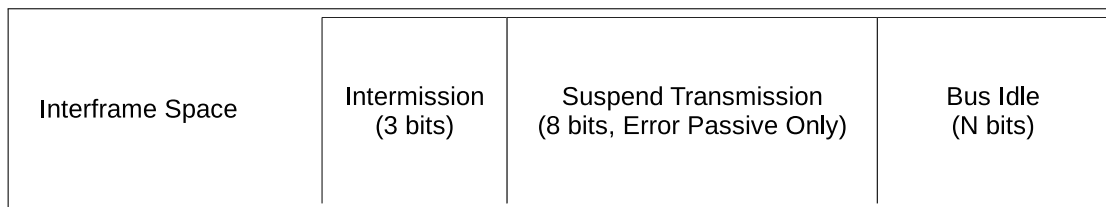


Figure 21-4. The Fields within an Interframe Space

### Bus Off

A Bus Off node is not permitted to influence the bus in any way (i.e., is not allowed to transmit anything).

### 21.3.3.3 Error Counters

The TEC and REC are incremented/decremented according to the following rules. **Note that more than one rule can apply for a given message transfer.**

1. When a Receiver detects an error, the REC will be increased by 1, except when the detected error was a Bit Error during the transmission of an Active Error Flag or an Overload Flag.
2. When a Receiver detects a Dominant bit as the first bit after sending an Error Flag, the REC will be increased by 8.
3. When a Transmitter sends an Error Flag the TEC is increased by 8. However, the following scenarios are exempt from this rule:
  - If a Transmitter is Error Passive that detects an Acknowledgment Error due to not detecting a Dominant bit in the ACK slot, it should send a Passive Error Flag. If no Dominant bit is detected in that Passive Error Flag, the TEC should not be increased.
  - A Transmitter transmits an Error Flag due to a Stuff Error during Arbitration. If the offending bit should have been Recessive but was monitored as Dominant, then the TEC should not be increased.
4. If a Transmitter detects a Bit Error whilst sending an Active Error Flag or Overload Flag, the REC is increased by 8.
5. If a Receiver detects a Bit Error while sending an Active Error Flag or Overload Flag, the REC is increased by 8.
6. Any node tolerates up to 7 consecutive Dominant bits after sending an Active/Passive Error Flag, or Overload Flag. After detecting the 14th consecutive Dominant bit (when sending an Active Error Flag or Overload Flag), or the 8th consecutive Dominant bit following a Passive Error Flag, a Transmitter will increase its TEC by 8 and a Receiver will increase its REC by 8. Each additional eight consecutive Dominant bits will also increase the TEC (for Transmitters) or REC (for Receivers) by 8 as well.
7. When a Transmitter successfully transmits a message (getting ACK and no errors until the EOF is complete), the TEC is decremented by 1, unless the TEC is already at 0.
8. When a Receiver successfully receives a message (no errors before ACK Slot, and successful sending of ACK), the REC is decremented.
  - If the REC was between 1 and 127, the REC is decremented by 1.
  - If the REC was greater than 127, the REC is set to 127.

- If the REC was 0, the REC remains 0.
9. A node becomes Error Passive when its TEC and/or REC is greater than or equal to 128. The error condition that causes a node to become Error Passive will cause the node to send an Active Error Flag. Note that once the REC has reached to 128, any further increases to its value are irrelevant until the REC returns to a value less than 128.
  10. A node becomes Bus Off when its TEC is greater than or equal to 256.
  11. An Error Passive node becomes Error Active when both the TEC and REC are less than or equal to 127.
  12. A Bus Off node can become Error Active (with both its TEC and REC reset to 0) after it monitors 128 occurrences of 11 consecutive Recessive bits on the bus.

### 21.3.4 TWAI Bit Timing

#### 21.3.4.1 Nominal Bit

The TWAI protocol allows a TWAI bus to operate at a particular bit rate. However, all nodes within a TWAI bus must operate at the same bit rate.

- The **Nominal Bit Rate** is defined as number of bits transmitted per second from an ideal Transmitter and without any synchronization.
- The **Nominal Bit Time** is defined as  $1/\text{Nominal Bit Rate}$ .

A single Nominal Bit Time is divided into multiple segments, and each segment is made up of multiple Time Quanta. A **Time Quantum** is a fixed unit of time, and is implemented as some form of prescaled clock signal in each node. Figure 21-5 illustrates the segments within a single Nominal Bit Time.

TWAI Controllers will operate in time steps of one Time Quanta where the state of the TWAI bus is analyzed at every Time Quanta. If two consecutive Time Quantas have different bus states (i.e., Recessive to Dominant or vice versa), this will be considered an edge. When the bus is analyzed at the intersection of PBS1 and PBS2, this is considered the Sample Point and the sampled bus value is considered the value of that bit.

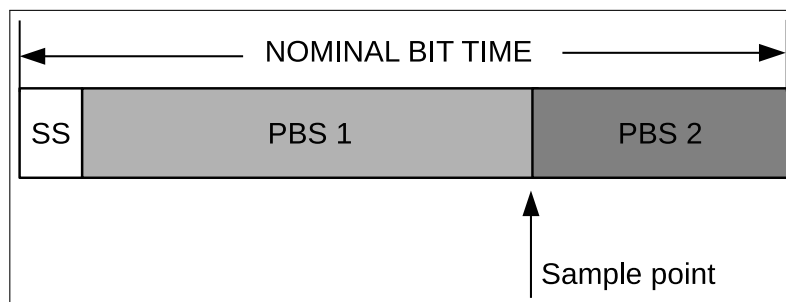


Figure 21-5. Layout of a Bit

Table 21-5. Segments of a Nominal Bit Time

Segment	Description
SS	The SS (Synchronization Segment) is 1 Time Quantum long. If all nodes are perfectly synchronized, the edge of a bit will lie in the SS.
PBS1	PBS1 (Phase Buffer Segment 1) can be 1 to 16 Time Quanta long. PBS1 is meant to compensate for the physical delay times within the network. PBS1 can also be lengthened for synchronization purposes.

Segment	Description
PBS2	PBS2 (Phase Buffer Segment 2) can be 1 to 8 Time Quanta long. PBS2 is meant to compensate for the information processing time of nodes. PBS2 can also be shortened for synchronization purposes.

### 21.3.4.2 Hard Synchronization and Resynchronization

Due to clock skew and jitter, the bit timing of nodes on the same bus may become out of phase. Therefore, a bit edge may come before or after the SS. To ensure that the internal bit timing clocks of each node are kept in phase, TWAI has various methods of synchronization. The **Phase Error “e”** is measured in the number of Time Quanta and relative to the SS.

- A positive Phase Error ( $e > 0$ ) is when the edge lies after the SS and before the Sample Point (i.e., the edge is late).
- A negative Phase Error ( $e < 0$ ) is when the edge lies after the Sample Point of the previous bit and before SS (i.e., the edge is early).

To correct for Phase Errors, there are two forms of synchronization, known as **Hard Synchronization** and **Resynchronization**. **Hard Synchronization** and **Resynchronization** obey the following rules.

- Only one synchronization may occur in a single bit time.
- Synchronizations only occurs on Recessive to Dominant edges.

#### Hard Synchronization

Hard Synchronization occurs on the Recessive to Dominant edges during Bus Idle (i.e., the SOF bit). All nodes will restart their internal bit timings such that the Recessive to Dominant edge lies within the SS of the restarted bit timing.

#### Resynchronization

Resynchronization occurs on Recessive to Dominant edges not during Bus Idle. If the edge has a positive Phase Error ( $e > 0$ ), PBS1 is lengthened by a certain number of Time Quanta. If the edge has a negative Phase Error ( $e < 0$ ), PBS2 will be shortened by a certain number of Time Quanta.

The number of Time Quanta to lengthen or shorten depends on the magnitude of the Phase Error, and is also limited by the Synchronization Jump Width (SJW) value which is a programmable.

- When the magnitude of the Phase Error is less than or equal to the SJW, PBS1/PBS2 are lengthened/shortened by **e** number of Time Quanta. This has a same effect as Hard Synchronization.
- When the magnitude of the Phase Error is greater to the SJW, PBS1/PBS2 are lengthened/shortened by the SJW number of Time Quanta. This means it may take multiple bits of synchronization before the Phase Error is entirely corrected.

## 21.4 Architectural Overview

The ESP32 contains a TWAI Controller. Figure 21-6 shows the major functional blocks of the TWAI Controller.

### 21.4.1 Registers Block

The ESP32 CPU accesses peripherals as 32-bit aligned words. However, the majority of registers in the TWAI controller only contain useful data at the least significant byte (bits [7:0]). Therefore, in these registers, bits [31:8] are ignored on writes, and return 0 on reads.

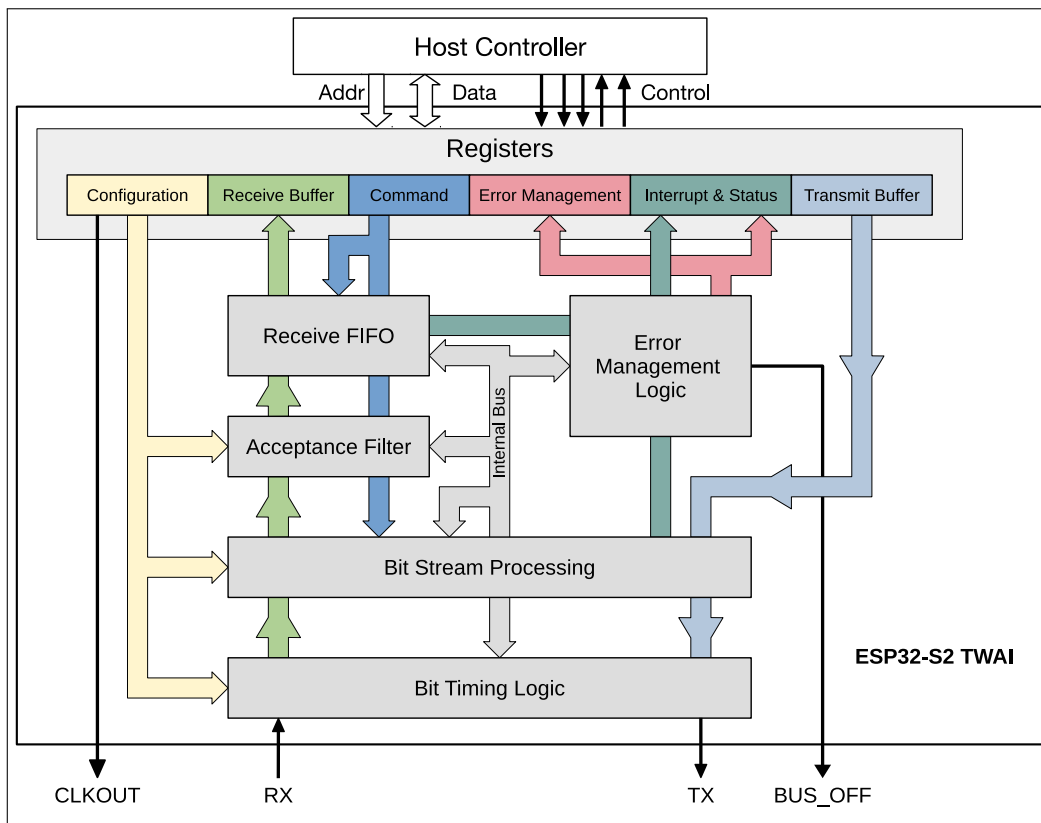


Figure 21-6. TWAI Overview Diagram

### Configuration Registers

The configuration registers store various configuration options for the TWAI controller such as bit rates, operating mode, Acceptance Filter etc. Configuration registers can only be modified whilst the TWAI controller is in Reset Mode (See Section 21.5.1).

### Command Register

The command register is used by the CPU to drive the TWAI controller to initiate certain actions such as transmitting a message or clearing the Receive Buffer. The command register can only be modified when the TWAI controller is in Operation Mode (see section 21.5.1).

### Interrupt & Status Registers

The interrupt register indicates what events have occurred in the TWAI controller (each event is represented by a separate bit). The status register indicates the current status of the TWAI controller.

### Error Management Registers

The error management registers include error counters and capture registers. The error counter registers represent TEC and REC values. The capture registers will record information about instances where TWAI controller detects a bus error, or when it loses arbitration.

### Transmit Buffer Registers

The transmit buffer is a 13-byte buffer used to store a TWAI message to be transmitted.

### Receive Buffer Registers

The Receive Buffer is a 13-byte buffer which stores a single message. The Receive Buffer acts as a window into Receive FIFO mapping to the first received message in the Receive FIFO to the Receive Buffer.

Note that the Transmit Buffer registers, Receive Buffer registers, and the Acceptance Filter registers share the same address range (offset 0x0040 to 0x0070). Their access is governed by the following rules:

- When the TWAI controller is in Reset Mode, the address range maps to the Acceptance Filter registers.
- When the TWAI controller is in Operation Mode:
  - All reads to the address range maps to the Receive Buffer registers.
  - All writes to the address range maps to the Transmit Buffer registers.

### 21.4.2 Bit Stream Processor

The Bit Stream Processing (BSP) module is responsible for framing data from the Transmit Buffer (e.g. bit stuffing and additional CRC fields) and generating a bit stream for the Bit Timing Logic (BTL) module. At the same time, the BSP module is also responsible for processing the received bit stream (e.g., de-stuffing and verifying CRC) from the BTL module and placing the message into the Receive FIFO. The BSP will also detect errors on the TWAI bus and report them to the Error Management Logic (EML).

### 21.4.3 Error Management Logic

The Error Management Logic (EML) module is responsible for updating the TEC and REC, recording error information like error types and positions, and updating the error state of the TWAI Controller such that the BSP module generates the correct Error Flags. Furthermore, this module also records the bit position when the TWAI controller loses arbitration.

### 21.4.4 Bit Timing Logic

The Bit Timing Logic (BTL) module is responsible for transmitting and receiving messages at the configured bit rate. The BTL module also handles synchronization of out of phase bits such that communication remains stable. A single bit time consists of multiple programmable segments that allows users to set the length of each segment to account for factors such as propagation delay and controller processing time etc.

### 21.4.5 Acceptance Filter

The Acceptance Filter is a programmable message filtering unit that allows the TWAI controller to accept or reject a received message based on the message's ID field. Only accepted messages will be stored in the Receive FIFO. The Acceptance Filter's registers can be programmed to specify a single filter, or specify two separate filters (dual filter mode).

### 21.4.6 Receive FIFO

The Receive FIFO is a 64-byte buffer (internal to the TWAI controller) that stores received messages accepted by the Acceptance Filter. Messages in the Receive FIFO can vary in size (between 3 to 13-bytes). When the Receive FIFO is full (or does not have enough space to store the next received message in its entirety), the Overrun Interrupt will be triggered, and any subsequent received messages will be lost until adequate space is cleared in the Receive FIFO. The first message in the Receive FIFO will be mapped to the 13-byte Receive Buffer until that message is cleared (using the Release Receive Buffer command bit). After clearing, the Receive Buffer will map to the next message in the Receive FIFO, and the space occupied by the previous message in the Receive FIFO can be used to receive new messages.

## 21.5 Functional Description

## 21.5.1 Modes

The ESP32 TWAI controller has two working modes: Reset Mode and Operation Mode. Reset Mode and Operation Mode are entered by setting the `TWAI_RESET_MODE` bit to 1 or 0 respectively.

### 21.5.1.1 Reset Mode

Entering Reset Mode is required in order to modify the various configuration registers of the TWAI controller. When entering Reset Mode, the TWAI controller is essentially disconnected from the TWAI bus. When in Reset Mode, the TWAI controller will not be able to transmit any messages (including error signaling). Any transmission in progress is immediately terminated. Likewise, the TWAI controller will also not be able to receive any messages.

### 21.5.1.2 Operation Mode

Entering Operation Mode essentially connects the TWAI controller to the TWAI bus, and write protects the TWAI controller's configuration registers ensuring the configuration stays consistent during operation. When in Operation Mode, the TWAI controller can transmit and receive messages (including error signaling) depending on which operating sub-mode the TWAI controller was configured with. The TWAI controller supports the following operating sub-modes:

- **Normal Mode:** The TWAI controller can transmit and receive messages including error signaling (such as Error and Overload Frames).
- **Self Test Mode:** Like Normal Mode, but the TWAI controller will consider the transmission of a Data or RTR Frame successful even if it was not acknowledged. This is commonly used when self testing the TWAI controller.
- **Listen Only Mode:** The TWAI controller will be able to receive messages, but will remain completely passive on the TWAI bus. Thus, the TWAI controller will not be able to transmit any messages, acknowledgments, or error signals. The error counters will remain frozen. This mode is useful for TWAI bus monitors.

Note that when exiting Reset Mode (i.e., entering Operation Mode), the TWAI controller must wait for 11 consecutive Recessive bits to occur before being able to fully connect the TWAI bus (i.e., be able to transmit or receive).

## 21.5.2 Bit Timing

The operating bit rate of the TWAI controller must be configured whilst the TWAI controller is in Reset Mode. The bit rate configuration is located in `TWAI_BUS_TIMING_0_REG` and `TWAI_BUS_TIMING_1_REG`, and the two registers contain the following fields:

The following Table 21-6 illustrates the bit fields of `TWAI_BUS_TIMING_0_REG`.

**Table 21-6. Bit Information of `TWAI_CLOCK_DIVIDER_REG`; TWAI Address 0x18**

Bit 31-8	Bit 7	Bit 6	Bit 5	Bit 4	Bit 3	Bit 2	Bit 1	Bit 0
Reserved	SJW.1	SJW.0	BRP.5	BRP.4	BRP.3	BRP.2	BRP.1	BRP.0

#### Notes:

- SJW: Synchronization Jump Width (SJW) is configured in SJW.0 and SJW.1 where  $SJW = (2 \times SJW.1 + SJW.0 + 1)$ .
- BRP: The TWAI Time Quanta clock is derived from a prescaled version of the APB clock that is usually 80

MHz. The Baud Rate Prescaler (BRP) field is used to define the prescaler according to the equation below, where  $t_{Tq}$  is the Time Quanta clock period and  $t_{CLK}$  is APB clock period :

$$t_{Tq} = 2 \times t_{CLK} \times (2^5 \times BRP.5 + 2^4 \times BRP.4 + 2^3 \times BRP.3 + 2^2 \times BRP.2 + 2^1 \times BRP.1 + 2^0 \times BRP.0 + 1)$$

The following Table 21-7 illustrates the bit fields of `TWAI_BUS_TIMING_1_REG`.

**Table 21-7. Bit Information of `TWAI_BUS_TIMING_1_REG`; TWAI Address 0x1c**

Bit 31-8	Bit 7	Bit 6	Bit 5	Bit 4	Bit 3	Bit 2	Bit 1	Bit 0
Reserved	SAM	PBS2.2	PBS2.1	PBS2.0	PBS1.3	PBS1.2	PBS1.1	PBS1.0

**Notes:**

- PBS1: The number of Time Quanta in Phase Buffer Segment 1 is defined according to the following equation:  $(8 \times PBS1.3 + 4 \times PBS1.2 + 2 \times PBS1.1 + PBS1.0 + 1)$ .
- PBS2: The number of Time Quanta in Phase Buffer Segment 2 is defined according to the following equation:  $(4 \times PBS2.2 + 2 \times PBS2.1 + PBS2.0 + 1)$ .
- SAM: Enables triple sampling if set to 1. This is useful for low/medium speed buses where filtering spikes on the bus line is beneficial.

### 21.5.3 Interrupt Management

The ESP32 TWAI controller provides seven interrupts, each represented by a single bit in the `TWAI_INT_RAW_REG`. For a particular interrupt to be triggered (i.e., its bit in `TWAI_INT_RAW_REG` set to 1), the interrupt's corresponding enable bit in `TWAI_INT_ENA_REG` must be set.

The TWAI controller provides the seven following interrupts:

- Receive Interrupt
- Transmit Interrupt
- Error Warning Interrupt
- Data Overrun Interrupt
- Error Passive Interrupt
- Arbitration Lost Interrupt
- Bus Error Interrupt

The TWAI controller's interrupt signal to the interrupt matrix will be asserted whenever one or more interrupt bits are set in the `TWAI_INT_RAW_REG`, and deasserted when all bits in `TWAI_INT_RAW_REG` are cleared. The majority of interrupt bits in `TWAI_INT_RAW_REG` are automatically cleared when the register is read. However, the Receive Interrupt is an exception and can only be cleared the Receive FIFO is empty.

#### 21.5.3.1 Receive Interrupt (RXI)

The Receive Interrupt (RXI) is asserted whenever the TWAI controller has received messages that are pending to read from the Receive Buffer (i.e., when `TWAI_RX_MESSAGE_CNT_REG` > 0). Pending received messages



includes valid messages in the Receive FIFO and also overrun messages. The RXI will not be deasserted until all pending received messages are cleared using the [TWAI\\_RELEASE\\_BUF](#) command bit.

### 21.5.3.2 Transmit Interrupt (TXI)

The Transmit Interrupt (TXI) is triggered whenever Transmit Buffer becomes free, indicating another message can be loaded into the Transmit Buffer to be transmitted. The Transmit Buffer becomes free under the following scenarios:

- A message transmission has completed successfully (i.e., Acknowledged without any errors). Any failed messages will automatically be retried.
- A single shot transmission has completed (successfully or unsuccessfully, indicated by the [TWAI\\_TX\\_COMPLETE](#) bit).
- A message transmission was aborted using the [TWAI\\_ABORT\\_TX](#) command bit.

### 21.5.3.3 Error Warning Interrupt (EWI)

The Error Warning Interrupt (EWI) is triggered whenever there is a change to the [TWAI\\_ERR\\_ST](#) and [TWAI\\_BUS\\_OFF\\_ST](#) bits of the [TWAI\\_STATUS\\_REG](#) (i.e., transition from 0 to 1 or vice versa). Thus, an EWI could indicate one of the following events, depending on the values [TWAI\\_ERR\\_ST](#) and [TWAI\\_BUS\\_OFF\\_ST](#) at the moment the EWI is triggered.

- If [TWAI\\_ERR\\_ST](#) = 0 and [TWAI\\_BUS\\_OFF\\_ST](#) = 0:
  - If the TWAI controller was in the Error Active state, it indicates both the TEC and REC have returned below the threshold value set by [TWAI\\_ERR\\_WARNING\\_LIMIT\\_REG](#).
  - If the TWAI controller was previously in the Bus Recovery state, it indicates that Bus Recovery has completed successfully.
- If [TWAI\\_ERR\\_ST](#) = 1 and [TWAI\\_BUS\\_OFF\\_ST](#) = 0: The TEC or REC error counters have exceeded the threshold value set by [TWAI\\_ERR\\_WARNING\\_LIMIT\\_REG](#).
- If [TWAI\\_ERR\\_ST](#) = 1 and [TWAI\\_BUS\\_OFF\\_ST](#) = 1: The TWAI controller has entered the BUS\_OFF state (due to the TEC  $\geq$  256).
- If [TWAI\\_ERR\\_ST](#) = 0 and [TWAI\\_BUS\\_OFF\\_ST](#) = 1: The TWAI controller's TEC has dropped below the threshold value set by [TWAI\\_ERR\\_WARNING\\_LIMIT\\_REG](#) during BUS\_OFF recovery.

### 21.5.3.4 Data Overrun Interrupt (DOI)

The Data Overrun Interrupt (DOI) is triggered when the message being read is overrun and invalid.

The DOI is only triggered on the first message that causes the Receive FIFO to overrun (i.e., the transition from the Receive FIFO not being full to the Receive FIFO overflowing). Any subsequent overrun messages will not trigger the DOI again. The DOI will only be able to trigger again when all received messages (valid or overrun) have been cleared.

### 21.5.3.5 Error Passive Interrupt (TXI)

The Error Passive Interrupt (EPI) is triggered whenever the TWAI controller transitions from Error Active to Error Passive, or vice versa.

### 21.5.3.6 Arbitration Lost Interrupt (ALI)

The Arbitration Lost Interrupt (ALI) is triggered whenever the TWAI controller is attempting to transmit a message and loses arbitration. The bit position where the TWAI controller lost arbitration is automatically recorded in Arbitration Lost Capture register ([TWAI\\_ARB\\_LOST\\_CAP\\_REG](#)). When the ALI occurs again, the Arbitration Lost Capture register will no longer record new bit location until it is cleared (via a read from the CPU).

### 21.5.3.7 Bus Error Interrupt (BEI)

The Bus Error Interrupt (BEI) is triggered whenever TWAI controller observes an error on the TWAI bus. When a bus error occurs, the Bus Error type and its bit position are automatically recorded in the Error Code Capture register ([TWAI\\_ERR\\_CODE\\_CAP\\_REG](#)). When the BEI occurs again, the Error Code Capture register will no longer record new error information until it is cleared (via a read from the CPU).

## 21.5.4 Transmit and Receive Buffers

### 21.5.4.1 Overview of Buffers

**Table 21-8. Buffer Layout for Standard Frame Format and Extended Frame Format**

Standard Frame Format (SFF)		Extended Frame Format (EFF)	
TWAI address	Content	TWAI address	Content
0x40	TX/RX frame information	0x40	TX/RX frame information
0x44	TX/RX identifier 1	0x44	TX/RX identifier 1
0x48	TX/RX identifier 2	0x48	TX/RX identifier 2
0x4c	TX/RX data byte 1	0x4c	TX/RX identifier 3
0x50	TX/RX data byte 2	0x50	TX/RX identifier 4
0x54	TX/RX data byte 3	0x54	TX/RX data byte 1
0x58	TX/RX data byte 4	0x58	TX/RX data byte 2
0x5c	TX/RX data byte 5	0x5c	TX/RX data byte 3
0x60	TX/RX data byte 6	0x60	TX/RX data byte 4
0x64	TX/RX data byte 7	0x64	TX/RX data byte 5
0x68	TX/RX data byte 8	0x68	TX/RX data byte 6
0x6c	reserved	0x6c	TX/RX data byte 7
0x70	reserved	0x70	TX/RX data byte 8

Table 21-8 illustrates the layout of the Transmit Buffer and Receive Buffer registers. Both the Transmit and Receive Buffer registers share the same address space and are only accessible when the TWAI controller is in Operation Mode. CPU write operations will access the Transmit Buffer registers, and CPU read operations will access the Receive Buffer registers. However, both buffers share the exact same register layout and fields to represent a message (received or to be transmitted). The Transmit Buffer registers are used to configure a TWAI message to be transmitted. The CPU would write to the Transmit Buffer registers specifying the message's frame type, frame

format, frame ID, and frame data (payload). Once the Transmit Buffer is configured, the CPU would then initiate the transmission by setting the `TWAI_TX_REQ` bit in `TWAI_CMD_REG`.

- For a self-reception request, set the `TWAI_SELF_RX_REQ` bit instead.
- For a single-shot transmission, set both the `TWAI_TX_REQ` and the `TWAI_ABORT_TX` simultaneously.

The Receive Buffer registers map to the first message in the Receive FIFO. The CPU would read the Receive Buffer registers to obtain the first message's frame type, frame format, frame ID, and frame data (payload). Once the message has been read from the Receive Buffer registers, the CPU can set the `TWAI_RELEASE_BUF` bit in `TWAI_CMD_REG` so that the next message in the Receive FIFO will be loaded in to the Receive Buffer registers.

### 21.5.4.2 Frame Information

The frame information is one byte long and specifies a message's frame type, frame format, and length of data. The frame information fields are shown in Table 21-9.

**Table 21-9. TX/RX Frame Information (SFF/EFF) TWAI Address 0x40**

Bit 31-8	Bit 7	Bit 6	Bit 5	Bit 4	Bit 3	Bit 2	Bit 1	Bit 0
Reserved	FF <sup>1</sup>	RTR <sup>2</sup>	X <sup>3</sup>	X <sup>3</sup>	XDLC.3 <sup>4</sup>	DLC.2 <sup>4</sup>	DLC.1 <sup>4</sup>	DLC.0 <sup>4</sup>

#### Notes:

- FF: The Frame Format (FF) bit specifies whether the message is Extended Frame Format (EFF) or Standard Frame Format (SFF). The message is EFF when FF bit is 1, and SFF when FF bit is 0.
- RTR: The Remote Transmission Request (RTR) bit specifies whether the message is a Data Frame or a Remote Frame. The message is a Remote Frame when the RTR bit is 1, and a Data Frame when the RTR bit is 0.
- DLC: The Data Length Code (DLC) field specifies the number of data bytes for a Data Frame, or the number of data bytes to request in a Remote Frame. TWAI Data Frames are limited to a maximum payload of 8 data bytes, thus the DLC should range anywhere from 0 to 8.
- X: Don't care, can be any value.

### 21.5.4.3 Frame Identifier

The Frame Identifier fields is 2 bytes (11-bits) if the message is SFF, and 4 bytes (29-bits) if the message is EFF.

The Frame Identifier fields for an SFF (11-bits) message is shown in Table 21-10-21-11.

**Table 21-10. TX/RX Identifier 1 (SFF); TWAI Address 0x44**

Bit 31-8	Bit 7	Bit 6	Bit 5	Bit 4	Bit 3	Bit 2	Bit 1	Bit 0
Reserved	ID.28	ID.27	ID.26	ID.25	ID.24	ID.23	ID.22	ID.21

**Table 21-11. TX/RX Identifier 2 (SFF); TWAI Address 0x48**

Bit 31-8	Bit 7	Bit 6	Bit 5	Bit 4	Bit 3	Bit 2	Bit 1	Bit 0
Reserved	ID.20	ID.19	ID.18	X <sup>1</sup>	X <sup>2</sup>	X <sup>2</sup>	X <sup>2</sup>	X <sup>2</sup>

The Frame Identifier fields for an EFF (29-bits) message is shown in Table 21-12-21-15.

**Table 21-12. TX/RX Identifier 1 (EFF); TWAI Address 0x44**

Bit 31-8	Bit 7	Bit 6	Bit 5	Bit 4	Bit 3	Bit 2	Bit 1	Bit 0
Reserved	ID.28	ID.27	ID.26	ID.25	ID.24	ID.23	ID.22	ID.21

**Table 21-13. TX/RX Identifier 2 (EFF); TWAI Address 0x4c**

Bit 31-8	Bit 7	Bit 6	Bit 5	Bit 4	Bit 3	Bit 2	Bit 1	Bit 0
Reserved	ID.20	ID.19	ID.18	ID.17	ID.16	ID.15	ID.14	ID.13

**Table 21-14. TX/RX Identifier 3 (EFF); TWAI Address 0x4c**

Bit 31-8	Bit 7	Bit 6	Bit 5	Bit 4	Bit 3	Bit 2	Bit 1	Bit 0
Reserved	ID.12	ID.11	ID.10	ID.9	ID.8	ID.7	ID.6	ID.5

**Table 21-15. TX/RX Identifier 4 (EFF); TWAI Address 0x50**

Bit 31-8	Bit 7	Bit 6	Bit 5	Bit 4	Bit 3	Bit 2	Bit 1	Bit 0
Reserved	ID.4	ID.3	ID.2	ID.1	ID.0	X <sup>1</sup>	X <sup>2</sup>	X <sup>2</sup>

#### 21.5.4.4 Frame Data

The Frame Data fields contains the payload of transmitted or received a Data Frame, and can range from 0 to 8 bytes. The number of valid bytes should be equal to the DLC. However, if the DLC is larger than 8, the number of valid bytes would still be limited to 8. Remote Frames do not have data payloads, thus the Frame Data fields will be unused.

For example, when transmitting a Data Frame with 5 data bytes, the CPU should write a value of 5 to the DLC field, and then fill in data bytes 1 to 5 in the Frame Data fields. Likewise, when receiving a Data Frame with a DLC of 5, only data bytes 1 to 5 will contain valid payload data for the CPU to read.

#### 21.5.5 Receive FIFO and Data Overruns

The Receive FIFO is a 64-byte internal buffer used to store received messages in First In First Out order. A single received message can occupy between 3 to 13-bytes of space in the Receive FIFO, and their byte layout is identical to the register layout of the Receive Buffer registers. The Receive Buffer registers are mapped to the bytes of the first message in the Receive FIFO. When the TWAI controller receives a message, it will increment the value of `TWAI_RX_MESSAGE_COUNTER` up to a maximum of 64. If there is adequate space in the Receive FIFO, the message contents will be written into the Receive FIFO. Once a message has been read from the Receive Buffer, the `TWAI_RELEASE_BUF` bit should be set. This will decrement `TWAI_RX_MESSAGE_COUNTER` and free the space occupied by the first message in the Receive FIFO. The Receive Buffer will then map to the next message

in the Receive FIFO.

When the TWAI controller receives a message, but the Receive FIFO lacks the adequate free space to store the received message in its entirety (either due to the message contents being larger than the free space in the Receive FIFO, or the Receive FIFO being completely full), the Receive FIFO will internally mark overrun messages as invalid. Subsequent overrun messages will still increment the `TWAI_RX_MESSAGE_COUNTER` up to a maximum of 64.

To clear an overrun Receive FIFO, the `TWAI_RELEASE_BUF` must be repeatedly called until `TWAI_RX_MESSAGE_COUNTER` is 0. This has the effect of freeing all valid messages in the Receive FIFO and clearing all overrun messages.

### 21.5.6 Acceptance Filter

The Acceptance Filter allows the TWAI controller to filter out received messages based on their ID (and optionally their first data byte and frame type). Only accepted messages are passed on to the Receive FIFO. The use of Acceptance Filters allows for a more lightweight operation of the TWAI controller (e.g., less use of Receive FIFO, fewer Receive Interrupts) due to the TWAI Controller only needing to handle a subset of messages.

The Acceptance Filter configuration registers can only be accessed whilst the TWAI controller is in Reset Mode, due to those registers sharing the same address space as the Transmit Buffer and Receive Buffer registers.

The registers consist of a 32-bit Acceptance Code Value and a 32-bit Acceptance Mask Value. The Code value specifies a bit pattern in which each filtered bit of the message must match in order for the message to be accepted. The Mask value is able to mask out certain bits of the Code value (i.e., set as “Don’t Care” bits). Each filtered bit of the message must either match the acceptance code or be masked in order for the message to be accepted, as demonstrated in Figure 21-7.

The TWAI Controller Acceptance Filter allows the 32-bit Code and Mask values to either define a single filter (i.e., Single Filter Mode), or two filters (i.e., Dual Filter Mode). How the Acceptance Filter interprets the 32-bit code and mask values is dependent on whether Single Filter Mode is enabled, and the received message (i.e., SFF or EFF).

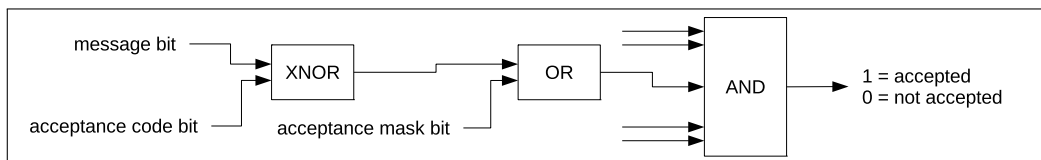


Figure 21-7. Acceptance Filter

#### 21.5.6.1 Single Filter Mode

Single Filter Mode is enabled by setting the `TWAI_RX_FILTER_MODE` bit to 1. This will cause the 32-bit code and mask values to define a single filter. The single filter can filter the following bits of a Data or Remote Frame:

- SFF
  - The entire 11-bit ID
  - RTR bit
  - Data byte 1 and Data byte 2
- EFF

- The entire 29-bit ID
- RTR bit

The following Figure 21-8 illustrates how the 32-bit code and mask values will be interpreted under Single Filter Mode.

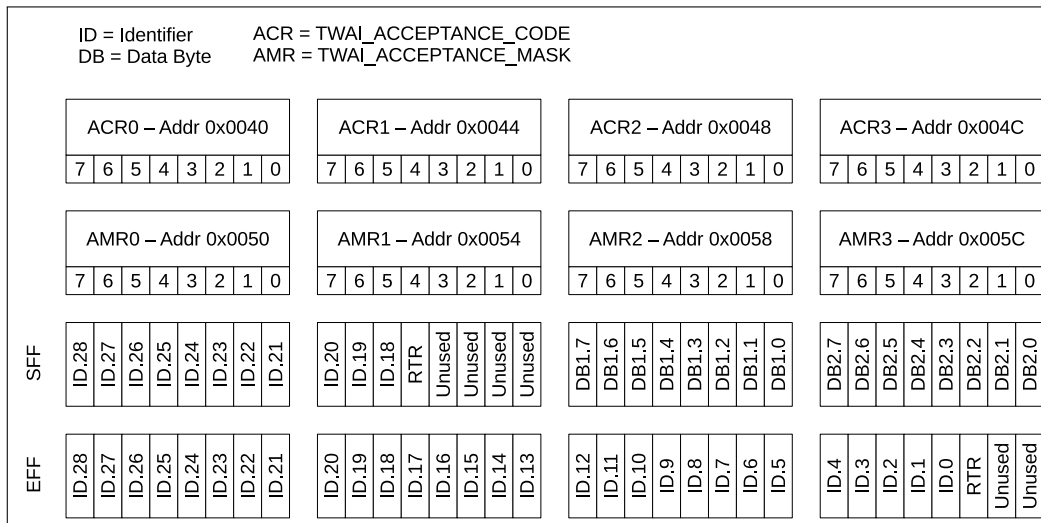


Figure 21-8. Single Filter Mode

### 21.5.6.2 Dual Filter Mode

Dual Filter Mode is enabled by setting the `TWAI_RX_FILTER_MODE` bit to 0. This will cause the 32-bit code and mask values to define a two separate filters, referred to as filter 1 or two. Under Dual Filter Mode, a message will be accepted if it is accepted by one of the two filters.

The two filters can filter the following bits of a Data or Remote Frame:

- SFF
  - The entire 11-bit ID
  - RTR bit
  - Data byte 1 (for filter 1 only)
- EFF
  - The first 16 bits of the 29-bit ID

The following Figure 21-9 illustrates how the 32-bit code and mask values will be interpreted under Dual Filter Mode.

### 21.5.7 Error Management

The TWAI protocol requires that each TWAI node maintains the Transmit Error Count (TEC) and Receive Error Count (REC). The value of both error counts determine the current error state of the TWAI controller (i.e., Error Active, Error Passive, Bus-Off). The TWAI controller stores the TEC and REC values in the `TWAI_TX_ERR_CNT_REG` and `TWAI_RX_ERR_CNT_REG` respectively, and can be read by the CPU at anytime. In addition to the error states, the TWAI controller also offers an Error Warning Limit (EWL) feature that can warn the user regarding the occurrence of severe bus errors before the TWAI controller enters the Error Passive state.

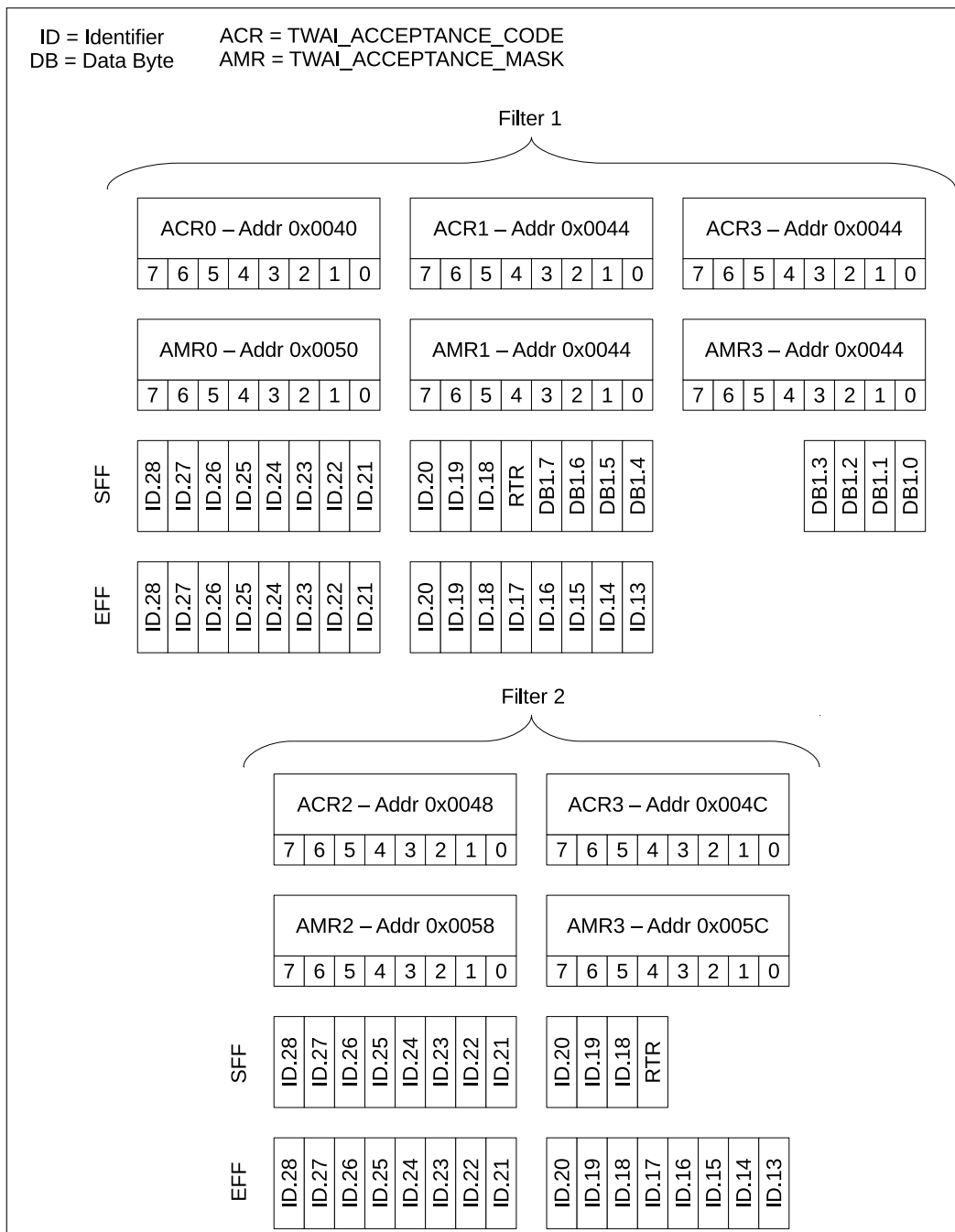


Figure 21-9. Dual Filter Mode

The current error state of the TWAI controller is indicated via a combination of the following values and status bits: TEC, REC, [TWAI\\_ERR\\_ST](#), and [TWAI\\_BUS\\_OFF\\_ST](#). Certain changes to these values and bits will also trigger interrupts, thus allowing the users to be notified of error state transitions (see section 21.5.3). The following figure 21-10 shows the relation between the error states, values and bits, and error state related interrupts.

### 21.5.7.1 Error Warning Limit

The Error Warning Limit (EWL) feature is a configurable threshold value for the TEC and REC, where if exceeded, will trigger an interrupt. The EWL is intended to serve as a warning about severe TWAI bus errors, and is triggered before the TWAI controller enters the Error Passive state. The EWL is configured in the [TWAI\\_ERR\\_WARNING\\_LIMIT\\_REG](#) and can only be configured whilst the TWAI controller is in Reset Mode. The [TWAI\\_ERR\\_WARNING\\_LIMIT\\_REG](#)

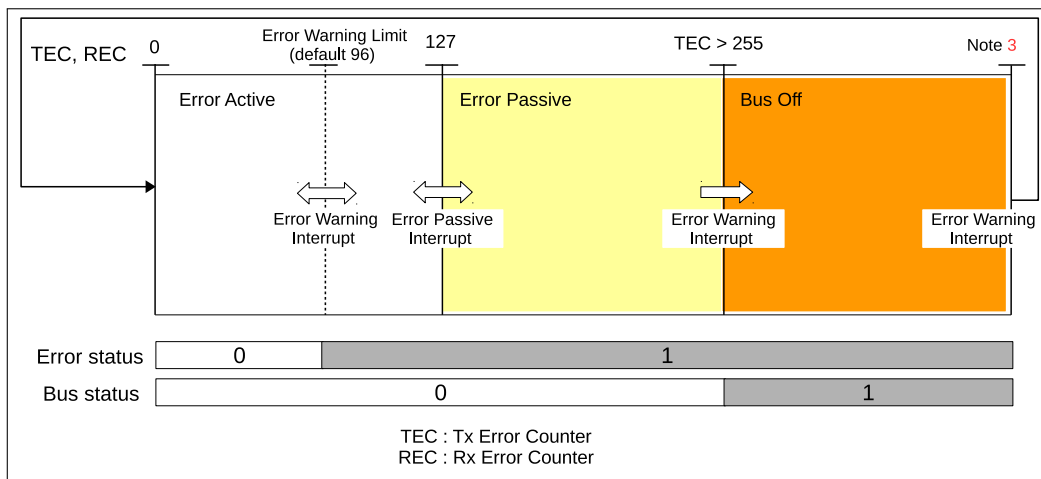


Figure 21-10. Error State Transition

has a default value of 96. When the values of TEC and/or REC are larger than or equal to the EWL value, the `TWAI_ERR_ST` bit is immediately set to 1. Likewise, when the values of both the TEC and REC are smaller than the EWL value, the `TWAI_ERR_ST` bit is immediately reset to 0. The Error Warning Interrupt is triggered whenever the value of the `TWAI_ERR_ST` bit (or the `TWAI_BUS_OFF_ST`) changes.

### 21.5.7.2 Error Passive

The TWAI controller is in the Error Passive state when the TEC or REC value exceeds 127. Likewise, when both the TEC and REC are less than or equal to 127, the TWAI controller enters the Error Active state. The Error Passive Interrupt is triggered whenever the TWAI controller transitions from the Error Active state to the Error Passive state or vice versa.

### 21.5.7.3 Bus-Off and Bus-Off Recovery

The TWAI controller enters the Bus-Off state when the TEC value exceeds 255. On entering the Bus-Off state, the TWAI controller will automatically do the following:

- Set REC to 0
- Set TEC to 127
- Set the `TWAI_BUS_OFF_ST` bit to 1
- Enter Reset Mode

The Error Warning Interrupt is triggered whenever the value of the `TWAI_BUS_OFF_ST` bit (or the `TWAI_ERR_ST` bit) changes.

To return to the Error Active state, the TWAI controller must undergo Bus-Off recovery. Bus-Off recovery requires the TWAI controller to observe 128 occurrences of 11 consecutive Recessive bits on the bus. To initiate Bus-Off recovery (after entering the Bus-Off state), the TWAI controller should enter Operation Mode by setting the `TWAI_RESET_MODE` bit to 0. The TEC tracks the progress of Bus-Off recovery by decrementing the TEC each time the TWAI controller observes 11 consecutive Recessive bits. When Bus-Off recovery has completed (i.e., TEC has decremented from 127 to 0), the `TWAI_BUS_OFF_ST` bit will automatically be reset to 0, thus triggering the Error Warning Interrupt.



### 21.5.8 Error Code Capture

The Error Code Capture (ECC) feature allows the TWAI controller to record the error type and bit position of a TWAI bus error in the form of an error code. Upon detecting a TWAI bus error, the Bus Error Interrupt is triggered and the error code is recorded in the `TWAI_ERR_CODE_CAP_REG`. Subsequent bus errors will trigger the Bus Error Interrupt, but their error codes will not be recorded until the current error code is read from the `TWAI_ERR_CODE_CAP_REG`.

The following Table 21-16 shows the fields of the `TWAI_ERR_CODE_CAP_REG`:

**Table 21-16. Bit Information of `TWAI_ERR_CODE_CAP_REG`; TWAI Address 0x30**

Bit 31-8	Bit 7	Bit 6	Bit 5	Bit 4	Bit 3	Bit 2	Bit 1	Bit 0
Reserved	ERRC.1 <sup>1</sup>	ERRC.0 <sup>1</sup>	DIR <sup>2</sup>	SEG.4 <sup>3</sup>	SEG.3 <sup>3</sup>	SEG.2 <sup>3</sup>	SEG.1 <sup>3</sup>	SEG.0 <sup>3</sup>

#### Notes:

- **ERRC:** The Error Code (ERRC) indicates the type of bus error: 00 for bit error, 01 for form error, 10 for stuff error, 11 for other type of error.
- **DIR:** The Direction (DIR) indicates whether the TWAI controller was transmitting or receiving when the bus error: 0 for Transmitter, 1 for Receiver.
- **SEG:** The Error Segment (SEG) indicates which segment of the TWAI message (i.e., bit position) the bus error occurred at.

The following Table 21-17 shows how to interpret the SEG.0 to SEG.4 bits.

**Table 21-17. Bit Information of Bits SEG.4 - SEG.0**

Bit SEG.4	Bit SEG.3	Bit SEG.2	Bit SEG.1	Bit SEG.0	Description
0	0	0	1	1	start of frame
0	0	0	1	0	ID.28 to ID.21
0	0	1	1	0	ID.20 to ID.18
0	0	1	0	0	bit SRTR <sup>1</sup>
0	0	1	0	1	bit IDE <sup>2</sup>
0	0	1	1	1	ID.17 to ID.13
0	1	1	1	1	ID.12 to ID.5
0	1	1	1	0	ID.4 to ID.0
0	1	1	0	0	bit RTR
0	1	1	0	1	reserved bit 1
0	1	0	0	1	reserved bit 0
0	1	0	1	1	data length code
0	1	0	1	0	data field
0	1	0	0	0	CRC sequence
1	1	0	0	0	CRC delimiter
1	1	0	0	1	acknowledge slot
1	1	0	1	1	acknowledge delimiter
1	1	0	1	0	end of frame
1	0	0	1	0	intermission

Bit SEG.4	Bit SEG.3	Bit SEG.2	Bit SEG.1	Bit SEG.0	Description
1	0	0	0	1	active error flag
1	0	1	1	0	passive error flag
1	0	0	1	1	tolerate dominant bits
1	0	1	1	1	error delimiter
1	1	1	0	0	overload flag

**Notes:**

- Bit RTR: under Standard Frame Format.
- Identifier Extension Bit: 0 for Standard Frame Format.

### 21.5.9 Arbitration Lost Capture

The Arbitration Lost Capture (ALC) feature allows the TWAI controller to record the bit position where it loses arbitration. When the TWAI controller loses arbitration, the bit position is recorded in the `TWAI_ARB_LOST_CAP_REG` and the Arbitration Lost Interrupt is triggered.

Subsequent loses in arbitration will trigger the Arbitration Lost Interrupt, but will not be recorded in the `TWAI_ARB_LOST_CAP_REG` until the current Arbitration Lost Capture is read from the `TWAI_ERR_CODE_CAP_REG`.

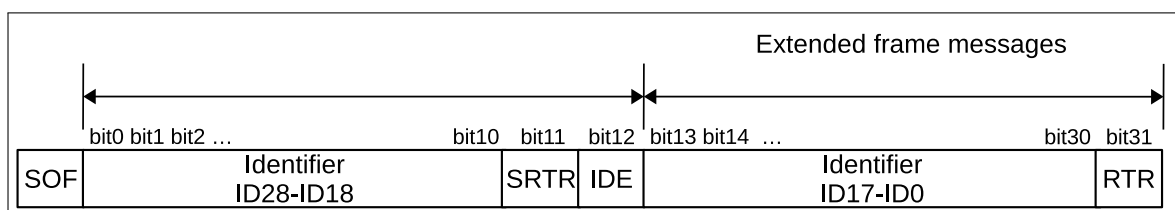
Table 21-18 illustrates the bit fields of the `TWAI_ERR_CODE_CAP_REG` whilst Figure 21-11 illustrates the bit positions of a TWAI message.

**Table 21-18. Bit Information of `TWAI_ARB_LOST_CAP_REG`; TWAI Address 0x2c**

Bit 31-5	Bit 4	Bit 3	Bit 2	Bit 1	Bit 0
Reserved	BITNO.4 <sup>1</sup>	BITNO.3 <sup>1</sup>	BITNO.2 <sup>1</sup>	BITNO.1 <sup>1</sup>	BITNO.0 <sup>1</sup>

**Notes:**

- BITNO: Bit Number (BITNO) indicates the nth bit of a TWAI message where arbitration was lost.



**Figure 21-11. Positions of Arbitration Lost Bits**

## 21.6 Register Summary

Name	Description	Address	Access
<b>Configuration Registers</b>			
<code>TWAI_MODE_REG</code>	Mode Register	0x3FF6B000	R/W
<code>TWAI_BUS_TIMING_0_REG</code>	Bus Timing Register 0	0x3FF6B018	RO   R/W
<code>TWAI_BUS_TIMING_1_REG</code>	Bus Timing Register 1	0x3FF6B01C	RO   R/W
<code>TWAI_ERR_WARNING_LIMIT_REG</code>	Error Warning Limit Register	0x3FF6B034	RO   R/W

Name	Description	Address	Access
TWAI_DATA_0_REG	Data Register 0	0x3FF6B040	WO   R/W
TWAI_DATA_1_REG	Data Register 1	0x3FF6B044	WO   R/W
TWAI_DATA_2_REG	Data Register 2	0x3FF6B048	WO   R/W
TWAI_DATA_3_REG	Data Register 3	0x3FF6B04C	WO   R/W
TWAI_DATA_4_REG	Data Register 4	0x3FF6B050	WO   R/W
TWAI_DATA_5_REG	Data Register 5	0x3FF6B054	WO   R/W
TWAI_DATA_6_REG	Data Register 6	0x3FF6B058	WO   R/W
TWAI_DATA_7_REG	Data Register 7	0x3FF6B05C	WO   R/W
TWAI_DATA_8_REG	Data Register 8	0x3FF6B060	WO   RO
TWAI_DATA_9_REG	Data Register 9	0x3FF6B064	WO   RO
TWAI_DATA_10_REG	Data Register 10	0x3FF6B068	WO   RO
TWAI_DATA_11_REG	Data Register 11	0x3FF6B06C	WO   RO
TWAI_DATA_12_REG	Data Register 12	0x3FF6B070	WO   RO
TWAI_CLOCK_DIVIDER_REG	Clock Divider Register	0x3FF6B07C	varies
<b>Control Registers</b>			
TWAI_CMD_REG	Command Register	0x3FF6B004	WO
<b>Status Registers</b>			
TWAI_STATUS_REG	Status Register	0x3FF6B008	RO
TWAI_ARB_LOST_CAP_REG	Arbitration Lost Capture Register	0x3FF6B02C	RO
TWAI_ERR_CODE_CAP_REG	Error Code Capture Register	0x3FF6B030	RO
TWAI_RX_ERR_CNT_REG	Receive Error Counter Register	0x3FF6B038	RO   R/W
TWAI_TX_ERR_CNT_REG	Transmit Error Counter Register	0x3FF6B03C	RO   R/W
TWAI_RX_MESSAGE_CNT_REG	Receive Message Counter Register	0x3FF6B074	RO
<b>Interrupt Registers</b>			
TWAI_INT_RAW_REG	Interrupt Register	0x3FF6B00C	RO
TWAI_INT_ENA_REG	Interrupt Enable Register	0x3FF6B010	R/W

## 21.7 Registers

Register 21.1. TWAI\_MODE\_REG (0x0000)

31	(reserved)																4	3	2	1	0	
																0	0	0	0	1	0	Reset

TWAI\_RX\_FILTER\_MODE  
 TWAI\_SELF\_TEST\_MODE  
 TWAI\_LISTEN\_ONLY\_MODE  
 TWAI\_RESET\_MODE

**TWAI\_RESET\_MODE** This bit is used to configure the operating mode of the TWAI Controller. 1: Reset mode; 0: Operating mode (R/W)

**TWAI\_LISTEN\_ONLY\_MODE** 1: Listen only mode. In this mode the nodes will only receive messages from the bus, without generating the acknowledge signal nor updating the RX error counter. (R/W)

**TWAI\_SELF\_TEST\_MODE** 1: Self test mode. In this mode the TX nodes can perform a successful transmission without receiving the acknowledge signal. This mode is often used to test a single node with the self reception request command. (R/W)

**TWAI\_RX\_FILTER\_MODE** This bit is used to configure the filter mode. 0: Dual filter mode; 1: Single filter mode (R/W)

Register 21.2. TWAI\_BUS\_TIMING\_0\_REG (0x0018)

31	(reserved)																8	7	6	5	0	
																0	0	0	0x0	0x00	Reset	

TWAI\_SYNC\_JUMP\_WIDTH  
 TWAI\_BAUD\_PRESC

**TWAI\_BAUD\_PRESC** Baud Rate Prescaler, determines the frequency dividing ratio. (RO | R/W)

**TWAI\_SYNC\_JUMP\_WIDTH** Synchronization Jump Width (SJW), 1 ~ 4 T<sub>q</sub> wide. (RO | R/W)

**Register 21.3. TWAI\_BUS\_TIMING\_1\_REG (0x001C)**

(reserved)	<i>TWAI_TIME_SAMP</i>	<i>TWAI_TIME_SEG2</i>	<i>TWAI_TIME_SEG1</i>
31	8	7	6
0	0	0x0	0x0

Reset

**TWAI\_TIME\_SEG1** The width of PBS1. (RO | R/W)

**TWAI\_TIME\_SEG2** The width of PBS2. (RO | R/W)

**TWAI\_TIME\_SAMP** The number of sample points. 0: the bus is sampled once; 1: the bus is sampled three times (RO | R/W)

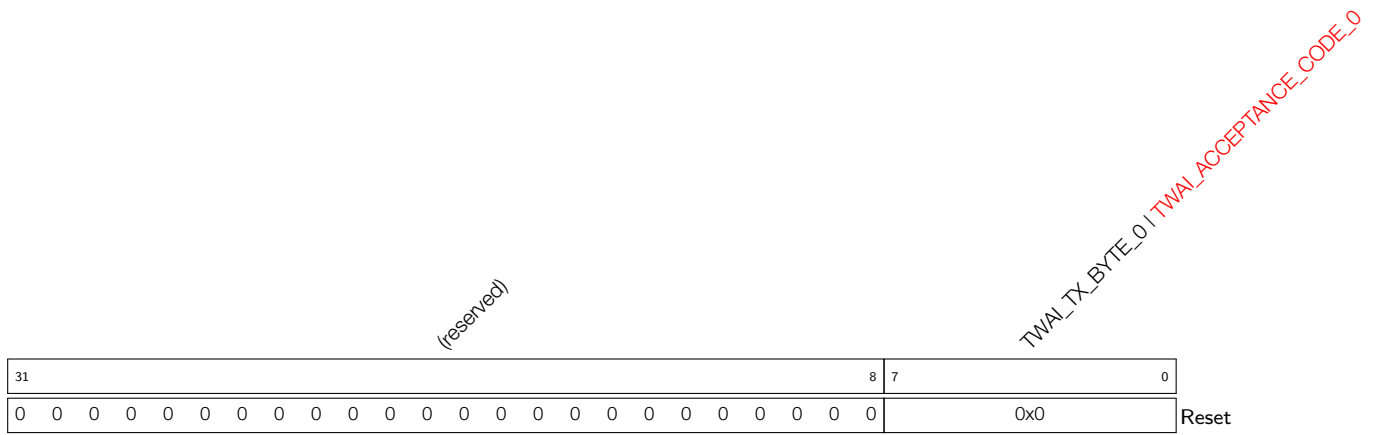
**Register 21.4. TWAI\_ERR\_WARNING\_LIMIT\_REG (0x0034)**

(reserved)	<i>TWAI_ERR_WARNING_LIMIT</i>
31	8
0	0x60

Reset

**TWAI\_ERR\_WARNING\_LIMIT** Error warning threshold. In the case when any of a error counter value exceeds the threshold, or all the error counter values are below the threshold, an error warning interrupt will be triggered (given the enable signal is valid). (RO | R/W)

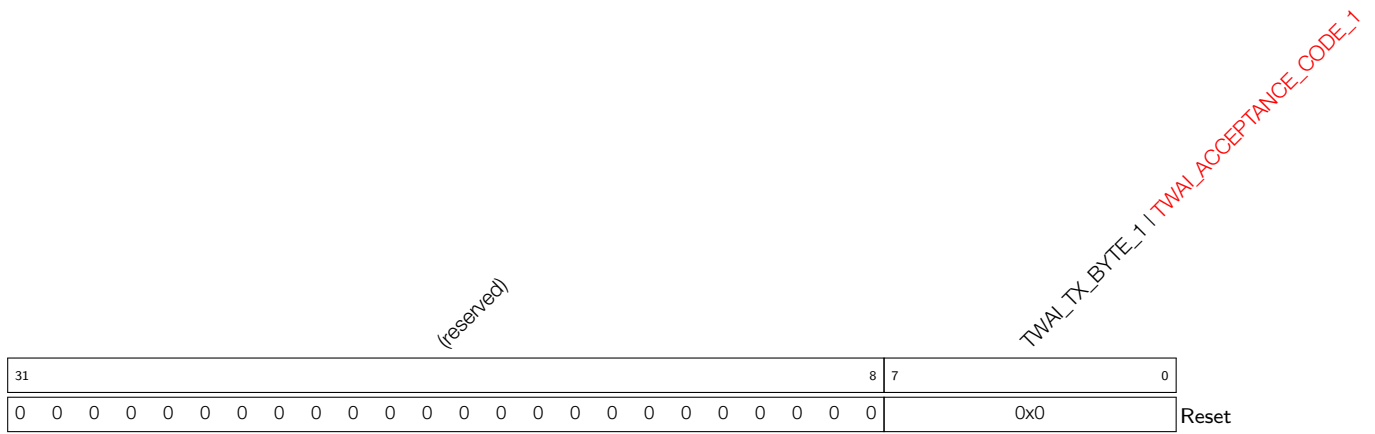
**Register 21.5. TWAI\_DATA\_0\_REG (0x0040)**



**TWAI\_TX\_BYTE\_0** Stored the 0th byte information of the data to be transmitted under operating mode. (WO)

**TWAI\_ACCEPTANCE\_CODE\_0** Stored the 0th byte of the filter code under reset mode. (R/W)

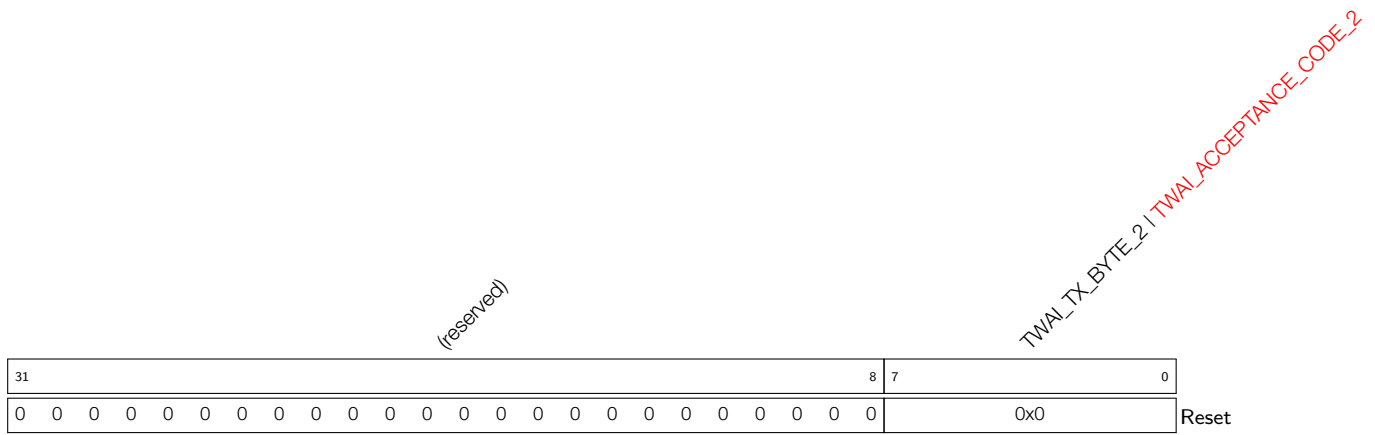
**Register 21.6. TWAI\_DATA\_1\_REG (0x0044)**



**TWAI\_TX\_BYTE\_1** Stored the 1st byte information of the data to be transmitted under operating mode. (WO)

**TWAI\_ACCEPTANCE\_CODE\_1** Stored the 1st byte of the filter code under reset mode. (R/W)

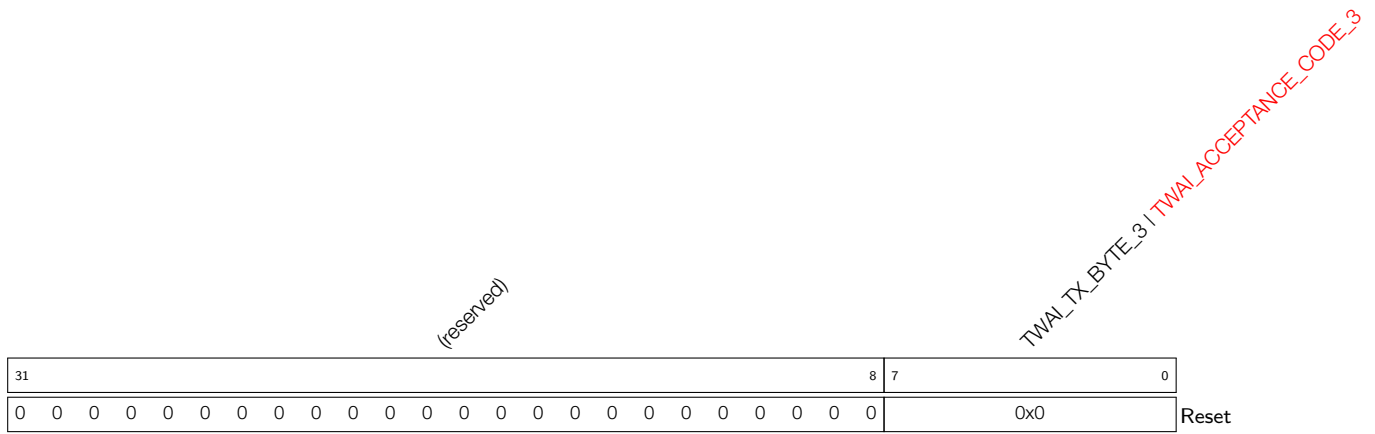
**Register 21.7. TWAI\_DATA\_2\_REG (0x0048)**



**TWAI\_TX\_BYTE\_2** Stored the 2nd byte information of the data to be transmitted under operating mode. (WO)

**TWAI\_ACCEPTANCE\_CODE\_2** Stored the 2nd byte of the filter code under reset mode. (R/W)

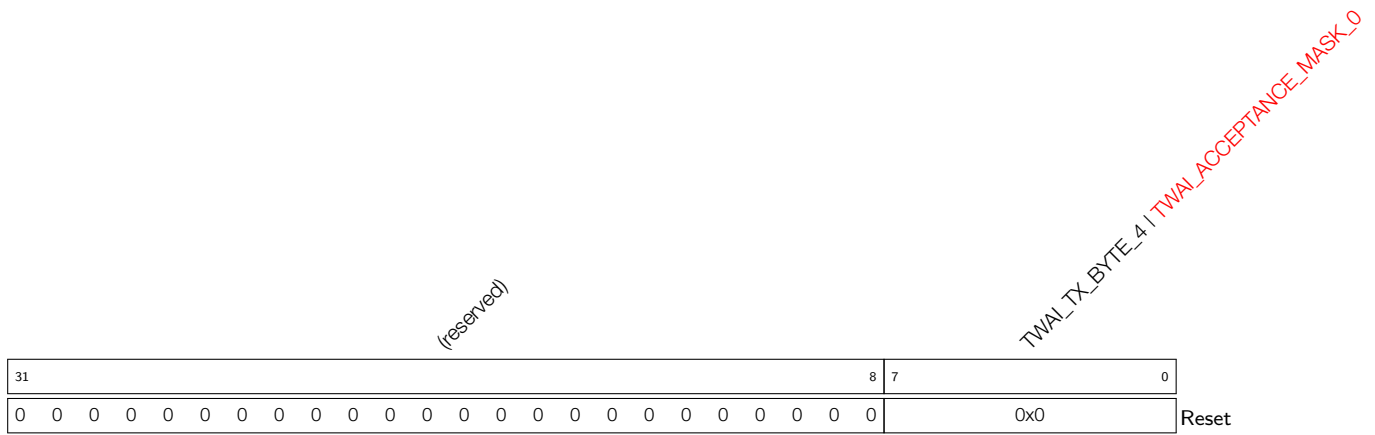
**Register 21.8. TWAI\_DATA\_3\_REG (0x004C)**



**TWAI\_TX\_BYTE\_3** Stored the 3rd byte information of the data to be transmitted under operating mode. (WO)

**TWAI\_ACCEPTANCE\_CODE\_3** Stored the 3rd byte of the filter code under reset mode. (R/W)

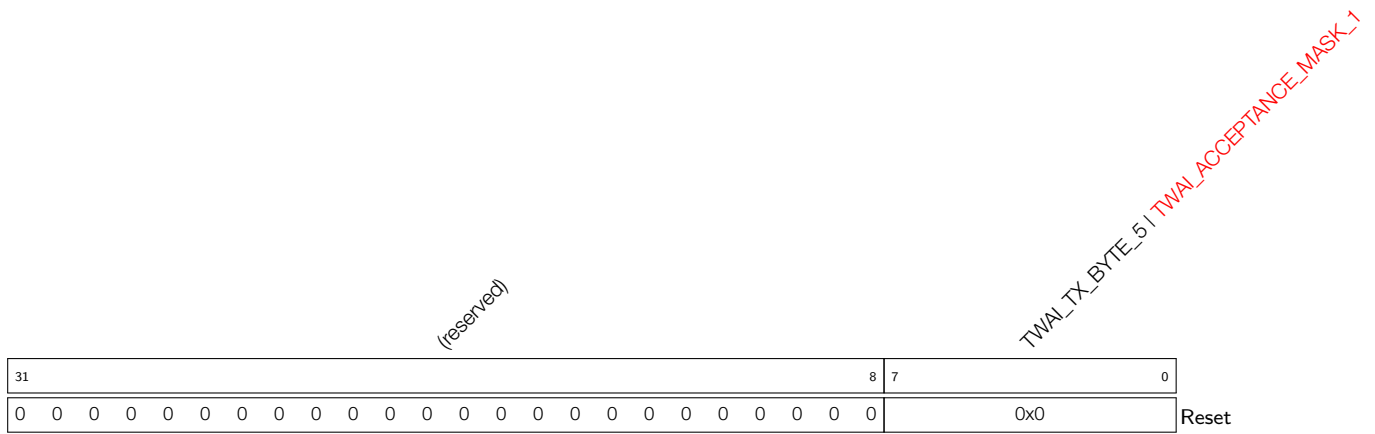
**Register 21.9. TWAI\_DATA\_4\_REG (0x0050)**



**TWAI\_TX\_BYTE\_4** Stored the 4th byte information of the data to be transmitted under operating mode. (WO)

**TWAI\_ACCEPTANCE\_MASK\_0** Stored the 0th byte of the filter code under reset mode. (R/W)

**Register 21.10. TWAI\_DATA\_5\_REG (0x0054)**

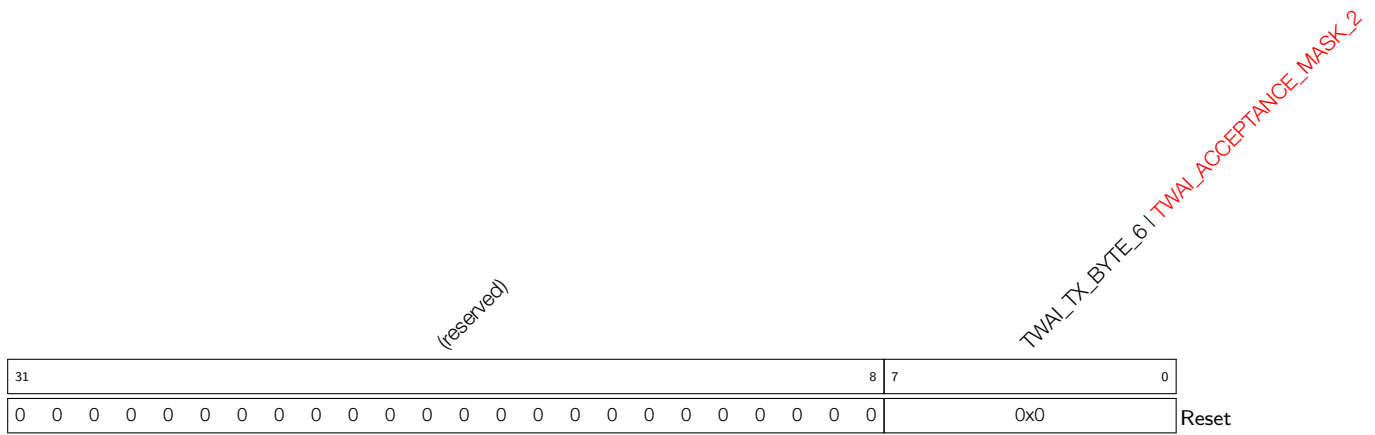


**TWAI\_TX\_BYTE\_5** Stored the 5th byte information of the data to be transmitted under operating mode. (WO)

**TWAI\_ACCEPTANCE\_MASK\_1** Stored the 1st byte of the filter code under reset mode. (R/W)



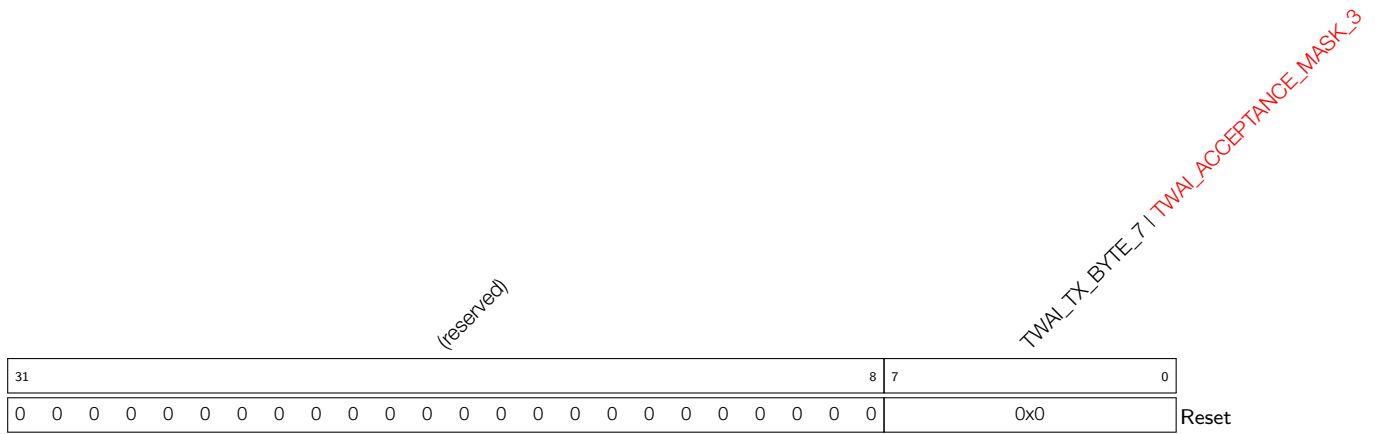
**Register 21.11. TWAI\_DATA\_6\_REG (0x0058)**



**TWAI\_TX\_BYTE\_6** Stored the 6th byte information of the data to be transmitted under operating mode. (WO)

**TWAI\_ACCEPTANCE\_MASK\_2** Stored the 2nd byte of the filter code under reset mode. (R/W)

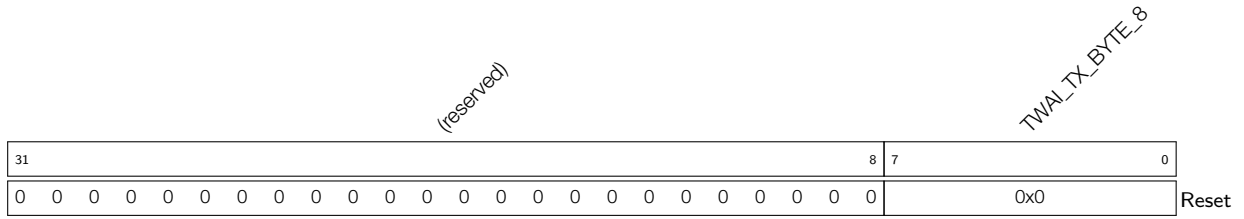
**Register 21.12. TWAI\_DATA\_7\_REG (0x005C)**



**TWAI\_TX\_BYTE\_7** Stored the 7th byte information of the data to be transmitted under operating mode. (WO)

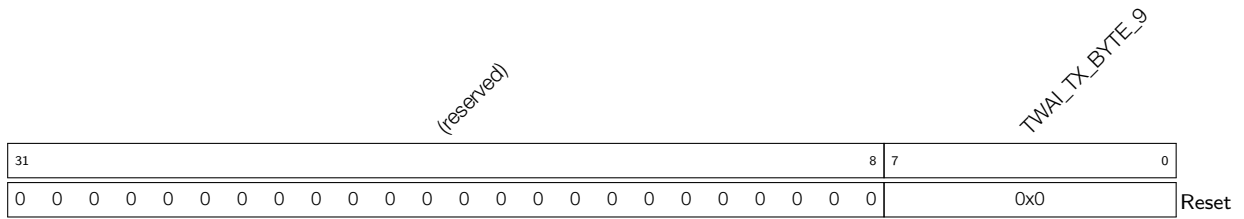
**TWAI\_ACCEPTANCE\_MASK\_3** Stored the 3rd byte of the filter code under reset mode. (R/W)

**Register 21.13. TWAI\_DATA\_8\_REG (0x0060)**



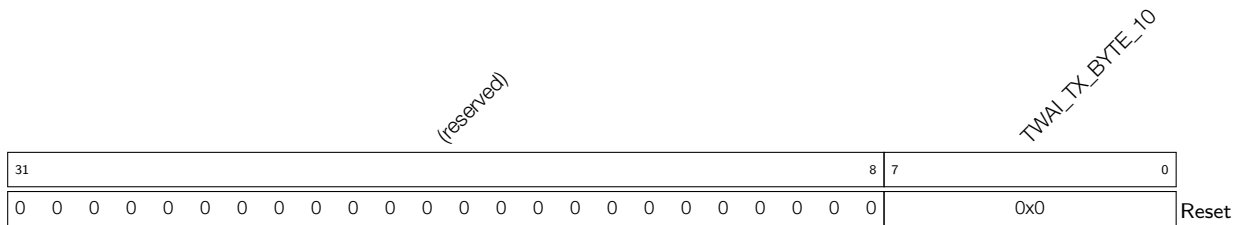
**TWAI\_TX\_BYTE\_8** Stored the 8th byte information of the data to be transmitted under operating mode. (WO)

**Register 21.14. TWAI\_DATA\_9\_REG (0x0064)**



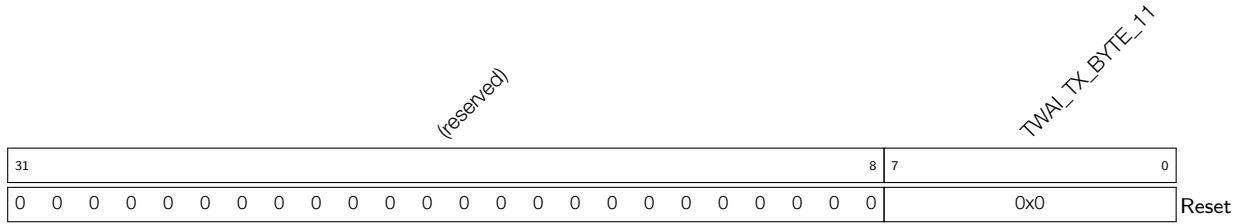
**TWAI\_TX\_BYTE\_9** Stored the 9th byte information of the data to be transmitted under operating mode. (WO)

**Register 21.15. TWAI\_DATA\_10\_REG (0x0068)**



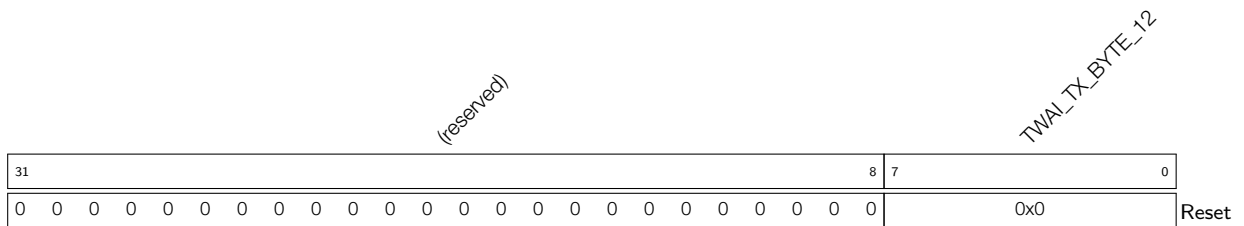
**TWAI\_TX\_BYTE\_10** Stored the 10th byte information of the data to be transmitted under operating mode. (WO)

**Register 21.16. TWAI\_DATA\_11\_REG (0x006C)**



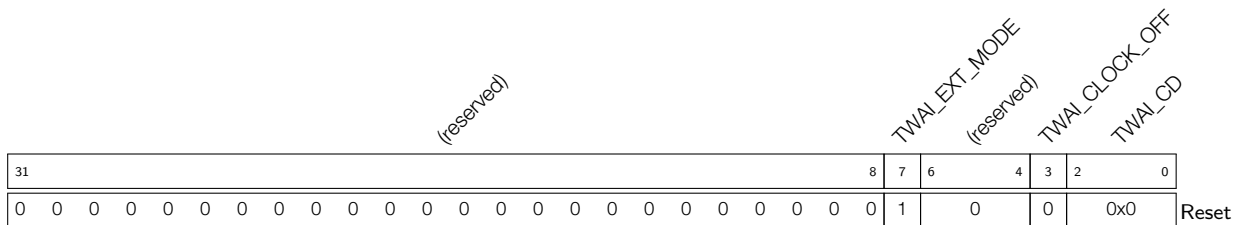
**TWAI\_TX\_BYTE\_11** Stored the 11th byte information of the data to be transmitted under operating mode. (WO)

**Register 21.17. TWAI\_DATA\_12\_REG (0x0070)**



**TWAI\_TX\_BYTE\_12** Stored the 12th byte information of the data to be transmitted under operating mode. (WO)

**Register 21.18. TWAI\_CLOCK\_DIVIDER\_REG (0x007C)**



**TWAI\_CD** These bits are used to configure frequency dividing coefficients of the external CLKOUT pin. (R/W)

**TWAI\_CLOCK\_OFF** This bit can be configured under reset mode. 1: Disable the external CLKOUT pin; 0: Enable the external CLKOUT pin (RO | R/W)

**TWAI\_EXT\_MODE** This bit can be configured under reset mode. 1: Extended mode, compatible with CAN2.0B; 0: Basic mode (RO | R/W)



**Register 21.21. TWAI\_ARB\_LOST\_CAP\_REG (0x002C)**

(reserved)	TWAI_ARB_LOST_CAP
31	0
5	4
0	0
0 0	0x0
	Reset

**TWAI\_ARB\_LOST\_CAP** This register contains information about the bit position of lost arbitration. (RO)

**Register 21.22. TWAI\_ERR\_CODE\_CAP\_REG (0x0030)**

(reserved)	TWAI_ECC_TYPE	TWAI_ECC_DIRECTION	TWAI_ECC_SEGMENT
31	8	7	6
5	4	0	0
0 0	0x0	0	0x0
			Reset

**TWAI\_ECC\_SEGMENT** This register contains information about the location of errors, see Table 21-16 for details. (RO)

**TWAI\_ECC\_DIRECTION** This register contains information about transmission direction of the node when error occurs. 1: Error occurs when receiving a message; 0: Error occurs when transmitting a message (RO)

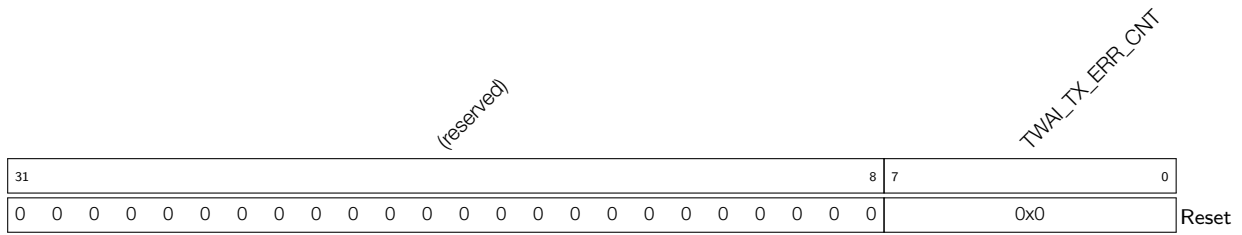
**TWAI\_ECC\_TYPE** This register contains information about error types: 00: bit error; 01: form error; 10: stuff error; 11: other type of error (RO)

**Register 21.23. TWAI\_RX\_ERR\_CNT\_REG (0x0038)**

(reserved)	TWAI_RX_ERR_CNT
31	8
7	0
0 0	0x0
	Reset

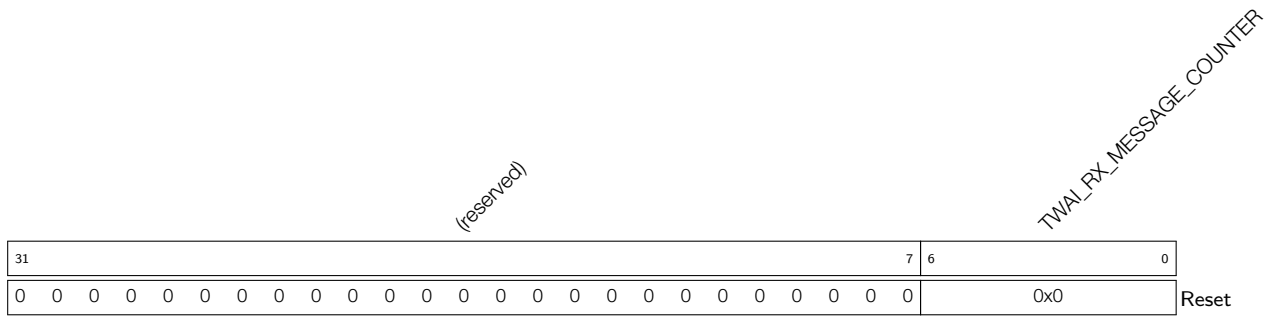
**TWAI\_RX\_ERR\_CNT** The RX error counter register, reflects value changes under reception status. (RO | R/W)

**Register 21.24. TWAI\_TX\_ERR\_CNT\_REG (0x003C)**



**TWAI\_TX\_ERR\_CNT** The TX error counter register, reflects value changes under transmission status.  
 (RO | R/W)

**Register 21.25. TWAI\_RX\_MESSAGE\_CNT\_REG (0x0074)**



**TWAI\_RX\_MESSAGE\_COUNTER** This register reflects the number of messages available within the RX FIFO. (RO)

## Register 21.26. TWAI\_INT\_RAW\_REG (0x000C)

(reserved)																TWAI_BUS_ERR_INT_ST TWAI_ARB_LOST_INT_ST TWAI_ERR_PASSIVE_INT_ST (reserved) TWAI_OVERRUN_INT_ST TWAI_ERR_WARN_INT_ST TWAI_TX_INT_ST TWAI_RX_INT_ST										
31																	8	7	6	5	4	3	2	1	0	Reset
0																0	0	0	0	0	0	0	0	0	0	0

**TWAI\_RX\_INT\_ST** Receive interrupt. If this bit is set to 1, it indicates there are messages to be handled in the RX FIFO. (RO)

**TWAI\_TX\_INT\_ST** Transmit interrupt. If this bit is set to 1, it indicates the message transmitting mission is finished and a new transmission is able to execute. (RO)

**TWAI\_ERR\_WARN\_INT\_ST** Error warning interrupt. If this bit is set to 1, it indicates the error status signal and the bus-off status signal of Status register have changed (e.g., switched from 0 to 1 or from 1 to 0). (RO)

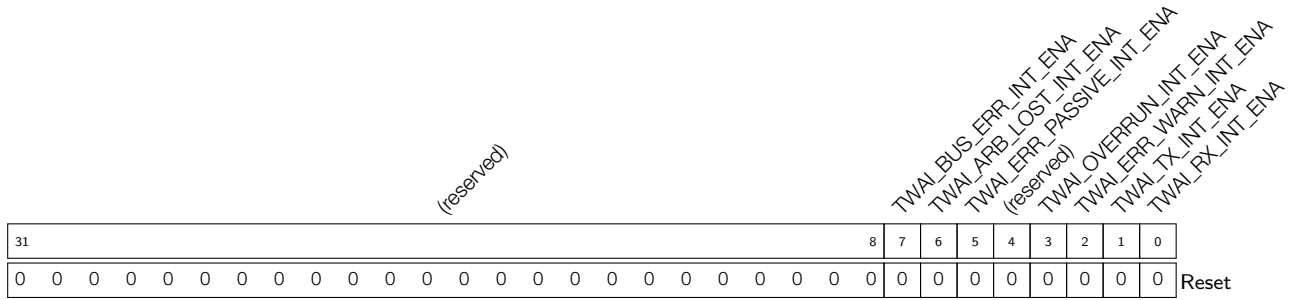
**TWAI\_OVERRUN\_INT\_ST** Data overrun interrupt. If this bit is set to 1, it indicates the data in the RX FIFO is invalid. (RO)

**TWAI\_ERR\_PASSIVE\_INT\_ST** Error passive interrupt. If this bit is set to 1, it indicates the TWAI Controller is switched between error active status and error passive status due to the change of error counters. (RO)

**TWAI\_ARB\_LOST\_INT\_ST** Arbitration lost interrupt. If this bit is set to 1, it indicates an arbitration lost interrupt is generated. (RO)

**TWAI\_BUS\_ERR\_INT\_ST** Error interrupt. If this bit is set to 1, it indicates an error is detected on the bus. (RO)

**Register 21.27. TWAI\_INT\_ENA\_REG (0x0010)**



**TWAI\_RX\_INT\_ENA** Set this bit to 1 to enable receive interrupt. (R/W)

**TWAI\_TX\_INT\_ENA** Set this bit to 1 to enable transmit interrupt. (R/W)

**TWAI\_ERR\_WARN\_INT\_ENA** Set this bit to 1 to enable error warning interrupt. (R/W)

**TWAI\_OVERRUN\_INT\_ENA** Set this bit to 1 to enable data overrun interrupt. (R/W)

**TWAI\_ERR\_PASSIVE\_INT\_ENA** Set this bit to 1 to enable error passive interrupt. (R/W)

**TWAI\_ARB\_LOST\_INT\_ENA** Set this bit to 1 to enable arbitration lost interrupt. (R/W)

**TWAI\_BUS\_ERR\_INT\_ENA** Set this bit to 1 to enable error interrupt. (R/W)



## 22 AES Accelerator (AES)

### 22.1 Introduction

The AES Accelerator speeds up AES operations significantly, compared to AES algorithms implemented solely in software. The AES Accelerator supports six algorithms of FIPS PUB 197, specifically AES-128, AES-192 and AES-256 encryption and decryption.

### 22.2 Features

- Supports AES-128 encryption and decryption
- Supports AES-192 encryption and decryption
- Supports AES-256 encryption and decryption
- Supports four variations of key endianness and four variations of text endianness

### 22.3 Functional Description

#### 22.3.1 AES Algorithm Operations

The AES Accelerator supports six algorithms of FIPS PUB 197, specifically AES-128, AES-192 and AES-256 encryption and decryption. The AES\_MODE\_REG register can be configured to different values to enable different algorithm operations, as shown in Table 22-1.

**Table 22-1. Operation Mode**

AES_MODE_REG[2:0]	Operation
0	AES-128 Encryption
1	AES-192 Encryption
2	AES-256 Encryption
4	AES-128 Decryption
5	AES-192 Decryption
6	AES-256 Decryption

#### 22.3.2 Key, Plaintext and Ciphertext

The encryption or decryption key is stored in AES\_KEY\_*n*\_REG, which is a set of eight 32-bit registers. For AES-128 encryption/decryption, the 128-bit key is stored in AES\_KEY\_0\_REG ~ AES\_KEY\_3\_REG. For AES-192 encryption/decryption, the 192-bit key is stored in AES\_KEY\_0\_REG ~ AES\_KEY\_5\_REG. For AES-256 encryption/decryption, the 256-bit key is stored in AES\_KEY\_0\_REG ~ AES\_KEY\_7\_REG.

Plaintext and ciphertext is stored in the AES\_TEXT\_*m*\_REG registers. There are four 32-bit registers. To enable AES-128/192/256 encryption, initialize the AES\_TEXT\_*m*\_REG registers with plaintext before encryption. When encryption is finished, the AES Accelerator will store back the resulting ciphertext in the AES\_TEXT\_*m*\_REG registers. To enable AES-128/192/256 decryption, initialize the AES\_TEXT\_*m*\_REG registers with ciphertext before decryption. When decryption is finished, the AES Accelerator will store back the resulting plaintext in the AES\_TEXT\_*m*\_REG registers.

#### 22.3.3 Endianness

##### Key Endianness

Bit 0 and bit 1 in AES\_ENDIAN\_REG define the key endianness. For detailed information, please see Table 22-3, Table 22-4 and Table 22-5.  $w[0] \sim w[3]$  in Table 22-3,  $w[0] \sim w[5]$  in Table 22-4 and  $w[0] \sim w[7]$  in Table 22-5 are “the first Nk words of the expanded key” as specified in “5.2: Key Expansion” of FIPS PUB 197. “Column Bit” specifies the bytes in the word from  $w[0]$  to  $w[7]$ . The bytes of AES\_KEY\_n\_REG comprise “the first Nk words of the expanded key”.

### Text Endianness

Bit 2 and bit 3 in AES\_ENDIAN\_REG define the endianness of input text, while Bit 4 and Bit 5 define the endianness of output text. The input text refers to the plaintext in AES-128/192/256 encryption and the ciphertext in decryption. The output text refers to the ciphertext in AES-128/192/256 encryption and the plaintext in decryption. For details, please see Table 22-2. “State” in Table 22-2 is defined as that in “3.4: The State” of FIPS PUB 197: “The AES algorithm operations are performed on a two-dimensional array of bytes called the State”. The ciphertext or plaintexts stored in each byte of AES\_TEXT\_m\_REG comprise the State.

**Table 22-2. AES Text Endianness**

AES_ENDIAN_REG[3]/[5]	AES_ENDIAN_REG[2]/[4]	Plaintext/Ciphertext					
0	0	State		c			
				0	1	2	3
		r	0	AES_TEXT_3_REG[31:24]	AES_TEXT_2_REG[31:24]	AES_TEXT_1_REG[31:24]	AES_TEXT_0_REG[31:24]
			1	AES_TEXT_3_REG[23:16]	AES_TEXT_2_REG[23:16]	AES_TEXT_1_REG[23:16]	AES_TEXT_0_REG[23:16]
			2	AES_TEXT_3_REG[15:8]	AES_TEXT_2_REG[15:8]	AES_TEXT_1_REG[15:8]	AES_TEXT_0_REG[15:8]
3	AES_TEXT_3_REG[7:0]		AES_TEXT_2_REG[7:0]	AES_TEXT_1_REG[7:0]	AES_TEXT_0_REG[7:0]		
0	1	State		c			
				0	1	2	3
		r	0	AES_TEXT_3_REG[7:0]	AES_TEXT_2_REG[7:0]	AES_TEXT_1_REG[7:0]	AES_TEXT_0_REG[7:0]
			1	AES_TEXT_3_REG[15:8]	AES_TEXT_2_REG[15:8]	AES_TEXT_1_REG[15:8]	AES_TEXT_0_REG[15:8]
			2	AES_TEXT_3_REG[23:16]	AES_TEXT_2_REG[23:16]	AES_TEXT_1_REG[23:16]	AES_TEXT_0_REG[23:16]
3	AES_TEXT_3_REG[31:24]		AES_TEXT_2_REG[31:24]	AES_TEXT_1_REG[31:24]	AES_TEXT_0_REG[31:24]		
1	0	State		c			
				0	1	2	3
		r	0	AES_TEXT_0_REG[31:24]	AES_TEXT_1_REG[31:24]	AES_TEXT_2_REG[31:24]	AES_TEXT_3_REG[31:24]
			1	AES_TEXT_0_REG[23:16]	AES_TEXT_1_REG[23:16]	AES_TEXT_2_REG[23:16]	AES_TEXT_3_REG[23:16]
			2	AES_TEXT_0_REG[15:8]	AES_TEXT_1_REG[15:8]	AES_TEXT_2_REG[15:8]	AES_TEXT_3_REG[15:8]
3	AES_TEXT_0_REG[7:0]		AES_TEXT_1_REG[7:0]	AES_TEXT_2_REG[7:0]	AES_TEXT_3_REG[7:0]		
1	1	State		c			
				0	1	2	3
		r	0	AES_TEXT_0_REG[7:0]	AES_TEXT_1_REG[7:0]	AES_TEXT_2_REG[7:0]	AES_TEXT_3_REG[7:0]
			1	AES_TEXT_0_REG[15:8]	AES_TEXT_1_REG[15:8]	AES_TEXT_2_REG[15:8]	AES_TEXT_3_REG[15:8]
			2	AES_TEXT_0_REG[23:16]	AES_TEXT_1_REG[23:16]	AES_TEXT_2_REG[23:16]	AES_TEXT_3_REG[23:16]
3	AES_TEXT_0_REG[31:24]		AES_TEXT_1_REG[31:24]	AES_TEXT_2_REG[31:24]	AES_TEXT_3_REG[31:24]		



### 22.3.4 Encryption and Decryption Operations

#### Single Operation

1. Initialize AES\_MODE\_REG, AES\_KEY\_n\_REG, AES\_TEXT\_m\_REG and AES\_ENDIAN\_REG.
2. Write 1 to AES\_START\_REG.
3. Wait until AES\_IDLE\_REG reads 1.
4. Read results from AES\_TEXT\_m\_REG.

#### Consecutive Operations

Every time an operation is completed, only AES\_TEXT\_m\_REG is modified by the AES Accelerator. Initialization can, therefore, be simplified in a series of consecutive operations.

1. Update contents of AES\_MODE\_REG, AES\_KEY\_n\_REG and AES\_ENDIAN\_REG, if required.
2. Load AES\_TEXT\_m\_REG.
3. Write 1 to AES\_START\_REG.
4. Wait until AES\_IDLE\_REG reads 1.
5. Read results from AES\_TEXT\_m\_REG.

### 22.3.5 Speed

The AES Accelerator requires 11 to 15 clock cycles to encrypt a message block, and 21 or 22 clock cycles to decrypt a message block.

## 22.4 Register Summary

Name	Description	Address	Access
<b>Configuration registers</b>			
AES_MODE_REG	Mode of operation of the AES Accelerator	0x3FF01008	R/W
AES_ENDIAN_REG	Endianness configuration register	0x3FF01040	R/W
<b>Key registers</b>			
AES_KEY_0_REG	AES key material register 0	0x3FF01010	R/W
AES_KEY_1_REG	AES key material register 1	0x3FF01014	R/W
AES_KEY_2_REG	AES key material register 2	0x3FF01018	R/W
AES_KEY_3_REG	AES key material register 3	0x3FF0101C	R/W
AES_KEY_4_REG	AES key material register 4	0x3FF01020	R/W
AES_KEY_5_REG	AES key material register 5	0x3FF01024	R/W
AES_KEY_6_REG	AES key material register 6	0x3FF01028	R/W
AES_KEY_7_REG	AES key material register 7	0x3FF0102C	R/W
<b>Encrypted/decrypted data registers</b>			
AES_TEXT_0_REG	AES encrypted/decrypted data register 0	0x3FF01030	R/W
AES_TEXT_1_REG	AES encrypted/decrypted data register 1	0x3FF01034	R/W
AES_TEXT_2_REG	AES encrypted/decrypted data register 2	0x3FF01038	R/W
AES_TEXT_3_REG	AES encrypted/decrypted data register 3	0x3FF0103C	R/W
<b>Control/status registers</b>			
AES_START_REG	AES operation start control register	0x3FF01000	WO

Name	Description	Address	Access
<a href="#">AES_IDLE_REG</a>	AES idle status register	0x3FF01004	RO

## 22.5 Registers

### Register 22.1. AES\_START\_REG (0x000)

(reserved)		AES_START	
31	1	0	
0x00000000		x	Reset

**AES\_START** Write 1 to start the AES operation. (WO)

### Register 22.2. AES\_IDLE\_REG (0x004)

(reserved)		AES_IDLE	
31	1	0	
0x00000000		1	Reset

**AES\_IDLE** AES Idle register. Reads 'zero' while the AES Accelerator is busy processing; reads 'one' otherwise. (RO)

### Register 22.3. AES\_MODE\_REG (0x008)

(reserved)		AES_MODE	
31	3	2	0
0x00000000		0	Reset

**AES\_MODE** Selects the AES accelerator mode of operation. See Table 22-1 for details. (R/W)

### Register 22.4. AES\_KEY\_n\_REG ( $n$ : 0-7) (0x10+4\*n)

31	0	
0x00000000		Reset

**AES\_KEY\_n\_REG** ( $n$ : 0-7) AES key material register. (R/W)

**Register 22.5. AES\_TEXT\_m\_REG (m: 0-3) (0x30+4\*m)**

31	0
0x00000000	
Reset	

**AES\_TEXT\_m\_REG (m: 0-3)** Plaintext and ciphertext register. (R/W)

**Register 22.6. AES\_ENDIAN\_REG (0x040)**

31	(reserved)	6	5	0	AES_ENDIAN
0x00000000			1 1 1 1 1 1		Reset

**AES\_ENDIAN** Endianness selection register. See Table 22-2 for details. (R/W)

## 23 SHA Accelerator (SHA)

### 23.1 Introduction

The SHA Accelerator is included to speed up SHA hashing operations significantly, compared to SHA hashing algorithms implemented solely in software. The SHA Accelerator supports four algorithms of FIPS PUB 180-4, specifically SHA-1, SHA-256, SHA-384 and SHA-512.

### 23.2 Features

Hardware support for popular secure hashing algorithms:

- SHA-1
- SHA-256
- SHA-384
- SHA-512

### 23.3 Functional Description

#### 23.3.1 Padding and Parsing the Message

The SHA Accelerator can only accept one message block at a time. Software divides the message into blocks according to “5.2 Parsing the Message” in FIPS PUB 180-4 and writes one block to the SHA\_TEXT\_0\_REG registers each time. For SHA-1 and SHA-256, software writes a 512-bit message block to SHA\_TEXT\_0\_REG ~ SHA\_TEXT\_15\_REG each time. For SHA-384 and SHA-512, software writes a 1024-bit message block to SHA\_TEXT\_0\_REG ~ SHA\_TEXT\_31\_REG each time.

The SHA Accelerator is unable to perform the padding operation of “5.1 Padding the Message” in FIPS PUB 180-4; Note that the user software is expected to pad the message before feeding it into the accelerator.

As described in “2.2.1: Parameters” in FIPS PUB 180-4, “ $M_0^{(i)}$  is the leftmost word of message block  $i$ ”.  $M_0^{(i)}$  is stored in SHA\_TEXT\_0\_REG. In the same fashion, the SHA\_TEXT\_1\_REG register stores the second left-most word of a message block  $M_1^{(N)}$ , etc.

#### 23.3.2 Message Digest

When the hashing operation is finished, the message digest will be refreshed by SHA Accelerator and will be stored in SHA\_TEXT\_0\_REG. SHA-1 produces a 160-bit message digest and stores it in SHA\_TEXT\_0\_REG ~ SHA\_TEXT\_4\_REG. SHA-256 produces a 256-bit message digest and stores it in SHA\_TEXT\_0\_REG ~ SHA\_TEXT\_7\_REG. SHA-384 produces a 384-bit message digest and stores it in SHA\_TEXT\_0\_REG ~ SHA\_TEXT\_11\_REG. SHA-512 produces a 512-bit message digest and stores it in SHA\_TEXT\_0\_REG ~ SHA\_TEXT\_15\_REG.

As described in “2.2.1 Parameters” in FIPS PUB 180-4, “ $H^{(N)}$  is the final hash value, and is used to determine the message digest”, while “ $H_0^{(i)}$  is the leftmost word of hash value  $i$ ”, so the leftmost word  $H_0^{(N)}$  in the message digest is stored in SHA\_TEXT\_0\_REG. In the same fashion, the second leftmost word  $H_1^{(N)}$  in the message digest is stored in SHA\_TEXT\_1\_REG, etc.

#### 23.3.3 Hash Operation

There is a set of control registers for SHA-1, SHA-256, SHA-384 and SHA-512, respectively; different hashing algorithms use different control registers.

SHA-1 uses SHA\_SHA1\_START\_REG, SHA\_SHA1\_CONTINUE\_REG, SHA\_SHA1\_LOAD\_REG and SHA\_SHA1\_BUSY\_REG.

SHA-256 uses SHA\_SHA256\_START\_REG, SHA\_SHA256\_CONTINUE\_REG, SHA\_SHA256\_LOAD\_REG and SHA\_SHA256\_BUSY\_REG. SHA-384 uses SHA\_SHA384\_START\_REG, SHA\_SHA384\_CONTINUE\_REG, SHA\_SHA384\_LOAD\_REG and SHA\_SHA384\_BUSY\_REG.

SHA-512 uses SHA\_SHA512\_START\_REG, SHA\_SHA512\_CONTINUE\_REG, SHA\_SHA512\_LOAD\_REG and SHA\_SHA512\_BUSY\_REG. The following steps describe the operation in a detailed manner.

1. Feed the accelerator with the first message block:
  - (a) Use the first message block to initialize SHA\_TEXT\_n\_REG.
  - (b) Write 1 to SHA\_X\_START\_REG.
  - (c) Wait for SHA\_X\_BUSY\_REG to read 0, indicating that the operation is completed.
2. Similarly, feed the accelerator with subsequent message blocks:
  - (a) Initialize SHA\_TEXT\_n\_REG using the subsequent message block.
  - (b) Write 1 to SHA\_X\_CONTINUE\_REG.
  - (c) Wait for SHA\_X\_BUSY\_REG to read 0, indicating that the operation is completed.
3. Get message digest:
  - (a) Write 1 to SHA\_X\_LOAD\_REG.
  - (b) Wait for SHA\_X\_BUSY\_REG to read 0, indicating that operation is completed.
  - (c) Read message digest from SHA\_TEXT\_n\_REG.

### 23.3.4 Speed

The SHA Accelerator requires 60 to 100 clock cycles to process a message block and 8 to 20 clock cycles to calculate the final digest.

## 23.4 Register Summary

Name	Description	Address	Access
<b>Encrypted/decrypted data registers</b>			
SHA_TEXT_0_REG	SHA encrypted/decrypted data register 0	0x3FF03000	R/W
SHA_TEXT_1_REG	SHA encrypted/decrypted data register 1	0x3FF03004	R/W
SHA_TEXT_2_REG	SHA encrypted/decrypted data register 2	0x3FF03008	R/W
SHA_TEXT_3_REG	SHA encrypted/decrypted data register 3	0x3FF0300C	R/W
SHA_TEXT_4_REG	SHA encrypted/decrypted data register 4	0x3FF03010	R/W
SHA_TEXT_5_REG	SHA encrypted/decrypted data register 5	0x3FF03014	R/W
SHA_TEXT_6_REG	SHA encrypted/decrypted data register 6	0x3FF03018	R/W
SHA_TEXT_7_REG	SHA encrypted/decrypted data register 7	0x3FF0301C	R/W
SHA_TEXT_8_REG	SHA encrypted/decrypted data register 8	0x3FF03020	R/W
SHA_TEXT_9_REG	SHA encrypted/decrypted data register 9	0x3FF03024	R/W
SHA_TEXT_10_REG	SHA encrypted/decrypted data register 10	0x3FF03028	R/W
SHA_TEXT_11_REG	SHA encrypted/decrypted data register 11	0x3FF0302C	R/W
SHA_TEXT_12_REG	SHA encrypted/decrypted data register 12	0x3FF03030	R/W



Name	Description	Address	Access
SHA_TEXT_13_REG	SHA encrypted/decrypted data register 13	0x3FF03034	R/W
SHA_TEXT_14_REG	SHA encrypted/decrypted data register 14	0x3FF03038	R/W
SHA_TEXT_15_REG	SHA encrypted/decrypted data register 15	0x3FF0303C	R/W
SHA_TEXT_16_REG	SHA encrypted/decrypted data register 16	0x3FF03040	R/W
SHA_TEXT_17_REG	SHA encrypted/decrypted data register 17	0x3FF03044	R/W
SHA_TEXT_18_REG	SHA encrypted/decrypted data register 18	0x3FF03048	R/W
SHA_TEXT_19_REG	SHA encrypted/decrypted data register 19	0x3FF0304C	R/W
SHA_TEXT_20_REG	SHA encrypted/decrypted data register 20	0x3FF03050	R/W
SHA_TEXT_21_REG	SHA encrypted/decrypted data register 21	0x3FF03054	R/W
SHA_TEXT_22_REG	SHA encrypted/decrypted data register 22	0x3FF03058	R/W
SHA_TEXT_23_REG	SHA encrypted/decrypted data register 23	0x3FF0305C	R/W
SHA_TEXT_24_REG	SHA encrypted/decrypted data register 24	0x3FF03060	R/W
SHA_TEXT_25_REG	SHA encrypted/decrypted data register 25	0x3FF03064	R/W
SHA_TEXT_26_REG	SHA encrypted/decrypted data register 26	0x3FF03068	R/W
SHA_TEXT_27_REG	SHA encrypted/decrypted data register 27	0x3FF0306C	R/W
SHA_TEXT_28_REG	SHA encrypted/decrypted data register 28	0x3FF03070	R/W
SHA_TEXT_29_REG	SHA encrypted/decrypted data register 29	0x3FF03074	R/W
SHA_TEXT_30_REG	SHA encrypted/decrypted data register 30	0x3FF03078	R/W
SHA_TEXT_31_REG	SHA encrypted/decrypted data register 31	0x3FF0307C	R/W
<b>Control/status registers</b>			
SHA_SHA1_START_REG	Control register to initiate SHA1 operation	0x3FF03080	WO
SHA_SHA1_CONTINUE_REG	Control register to continue SHA1 operation	0x3FF03084	WO
SHA_SHA1_LOAD_REG	Control register to calculate the final SHA1 hash	0x3FF03088	WO
SHA_SHA1_BUSY_REG	Status register for SHA1 operation	0x3FF0308C	RO
SHA_SHA256_START_REG	Control register to initiate SHA256 operation	0x3FF03090	WO
SHA_SHA256_CONTINUE_REG	Control register to continue SHA256 operation	0x3FF03094	WO
SHA_SHA256_LOAD_REG	Control register to calculate the final SHA256 hash	0x3FF03098	WO
SHA_SHA256_BUSY_REG	Status register for SHA256 operation	0x3FF0309C	RO
SHA_SHA384_START_REG	Control register to initiate SHA384 operation	0x3FF030A0	WO
SHA_SHA384_CONTINUE_REG	Control register to continue SHA384 operation	0x3FF030A4	WO
SHA_SHA384_LOAD_REG	Control register to calculate the final SHA384 hash	0x3FF030A8	WO
SHA_SHA384_BUSY_REG	Status register for SHA384 operation	0x3FF030AC	RO
SHA_SHA512_START_REG	Control register to initiate SHA512 operation	0x3FF030B0	WO
SHA_SHA512_CONTINUE_REG	Control register to continue SHA512 operation	0x3FF030B4	WO
SHA_SHA512_LOAD_REG	Control register to calculate the final SHA512 hash	0x3FF030B8	WO
SHA_SHA512_BUSY_REG	Status register for SHA512 operation	0x3FF030BC	RO

## 23.5 Registers

Register 23.1. SHA\_TEXT\_*n*\_REG (*n*: 0-31) (0x0+4\**n*)

31		0
0x00000000		Reset

**SHA\_TEXT\_*n*\_REG** (*n*: 0-31) SHA Message block and hash result register. (R/W)

Register 23.2. SHA\_SHA1\_START\_REG (0x080)

31	<i>(reserved)</i>	1	0	<i>SHA_SHA1_START</i>
0x00000000		0	Reset	

**SHA\_SHA1\_START** Write 1 to start an SHA-1 operation on the first message block. (WO)

Register 23.3. SHA\_SHA1\_CONTINUE\_REG (0x084)

31	<i>(reserved)</i>	1	0	<i>SHA_SHA1_CONTINUE</i>
0x00000000		0	Reset	

**SHA\_SHA1\_CONTINUE** Write 1 to continue the SHA-1 operation with subsequent blocks. (WO)

Register 23.4. SHA\_SHA1\_LOAD\_REG (0x088)

31	<i>(reserved)</i>	1	0	<i>SHA_SHA1_LOAD</i>
0x00000000		0	Reset	

**SHA\_SHA1\_LOAD** Write 1 to finish the SHA-1 operation to calculate the final message hash. (WO)

**Register 23.5. SHA\_SHA1\_BUSY\_REG (0x08C)**

31	<i>(reserved)</i>	1	0	SHA_SHA1_BUSY
0x00000000			0	

**SHA\_SHA1\_BUSY** SHA-1 operation status: 1 if the SHA accelerator is processing data, 0 if it is idle.  
(RO)

**Register 23.6. SHA\_SHA256\_START\_REG (0x090)**

31	<i>(reserved)</i>	1	0	SHA_SHA256_START
0x00000000			0	

**SHA\_SHA256\_START** Write 1 to start an SHA-256 operation on the first message block. (WO)

**Register 23.7. SHA\_SHA256\_CONTINUE\_REG (0x094)**

31	<i>(reserved)</i>	1	0	SHA_SHA256_CONTINUE
0x00000000			0	

**SHA\_SHA256\_CONTINUE** Write 1 to continue the SHA-256 operation with subsequent blocks. (WO)

**Register 23.8. SHA\_SHA256\_LOAD\_REG (0x098)**

31	<i>(reserved)</i>	1	0	
0x00000000		0		Reset

**SHA\_SHA256\_LOAD** Write 1 to finish the SHA-256 operation to calculate the final message hash. (WO)

**Register 23.9. SHA\_SHA256\_BUSY\_REG (0x09C)**

31	<i>(reserved)</i>	1	0	
0x00000000		0		Reset

**SHA\_SHA256\_BUSY** SHA-256 operation status: 1 if the SHA accelerator is processing data, 0 if it is idle. (RO)

**Register 23.10. SHA\_SHA384\_START\_REG (0x0A0)**

31	<i>(reserved)</i>	1	0	
0x00000000		0		Reset

**SHA\_SHA384\_START** Write 1 to start an SHA-384 operation on the first message block. (WO)

**Register 23.11. SHA\_SHA384\_CONTINUE\_REG (0x0A4)**

31	<i>(reserved)</i>	1	0	
			0	Reset
			0x00000000	

**SHA\_SHA384\_CONTINUE** Write 1 to continue the SHA-384 operation with subsequent blocks. (WO)

**Register 23.12. SHA\_SHA384\_LOAD\_REG (0x0A8)**

31	<i>(reserved)</i>	1	0	
			0	Reset
			0x00000000	

**SHA\_SHA384\_LOAD** Write 1 to finish the SHA-384 operation to calculate the final message hash. (WO)

**Register 23.13. SHA\_SHA384\_BUSY\_REG (0x0AC)**

31	<i>(reserved)</i>	1	0	
			0	Reset
			0x00000000	

**SHA\_SHA384\_BUSY** SHA-384 operation status: 1 if the SHA accelerator is processing data, 0 if it is idle. (RO)

## Register 23.14. SHA\_SHA512\_START\_REG (0x0B0)

31	<i>(reserved)</i>	1	0	
0x00000000				0
				Reset

**SHA\_SHA512\_START** Write 1 to start an SHA-512 operation on the first message block. (WO)

## Register 23.15. SHA\_SHA512\_CONTINUE\_REG (0x0B4)

31	<i>(reserved)</i>	1	0	
0x00000000				0
				Reset

**SHA\_SHA512\_CONTINUE** Write 1 to continue the SHA-512 operation with subsequent blocks. (WO)

## Register 23.16. SHA\_SHA512\_LOAD\_REG (0x0B8)

31	<i>(reserved)</i>	1	0	
0x00000000				0
				Reset

**SHA\_SHA512\_LOAD** Write 1 to finish the SHA-512 operation to calculate the final message hash.  
(WO)

## Register 23.17. SHA\_SHA512\_BUSY\_REG (0x0BC)

<i>(reserved)</i>		<i>SHA_SHA512_BUSY</i>
31	1	0
0x00000000		0 Reset

**SHA\_SHA512\_BUSY** SHA-512 operation status: 1 if the SHA accelerator is processing data, 0 if it is idle. (RO)

## 24 RSA Accelerator (RSA)

### 24.1 Introduction

The RSA Accelerator provides hardware support for multiple precision arithmetic operations used in RSA asymmetric cipher algorithms.

Sometimes, multiple precision arithmetic is also called "bignum arithmetic", "bigint arithmetic" or "arbitrary precision arithmetic".

### 24.2 Features

- Support for large-number modular exponentiation
- Support for large-number modular multiplication
- Support for large-number multiplication
- Support for various lengths of operands

### 24.3 Functional Description

#### 24.3.1 Initialization

The RSA Accelerator is activated by enabling the corresponding peripheral clock, and by clearing the DPORT\_RSA\_PD bit in the DPORT\_RSA\_PD\_CTRL\_REG register. This releases the RSA Accelerator from reset.

When the RSA Accelerator is released from reset, the register RSA\_CLEAN\_REG reads 0 and an initialization process begins. Hardware initializes the four memory blocks by setting them to 0. After initialization is complete, RSA\_CLEAN\_REG reads 1. For this reason, software should query RSA\_CLEAN\_REG after being released from reset, and before writing to any RSA Accelerator memory blocks or registers for the first time.

#### 24.3.2 Large Number Modular Exponentiation

Large-number modular exponentiation performs  $Z = X^Y \bmod M$ . The operation is based on Montgomery multiplication. Aside from the arguments  $X$ ,  $Y$ , and  $M$ , two additional ones are needed —  $\bar{r}$  and  $M'$ . These arguments are calculated in advance by software.

The RSA Accelerator supports operand lengths of  $N \in \{512, 1024, 1536, 2048, 2560, 3072, 3584, 4096\}$  bits. The bit length of arguments  $Z$ ,  $X$ ,  $Y$ ,  $M$ , and  $\bar{r}$  can be any one from the N set, but all numbers in a calculation must be of the same length. The bit length of  $M'$  is always 32.

To represent the numbers used as operands, define a base- $b$  positional notation, as follows:

$$b = 2^{32}$$

In this notation, each number is represented by a sequence of base- $b$  digits, where each base- $b$  digit is a 32-bit word. Representing an  $N$ -bit number requires  $n$  base- $b$  digits (all of the possible  $N$  lengths are multiples of



32).

$$n = \frac{N}{32}$$

$$Z = (Z_{n-1}Z_{n-2} \cdots Z_0)_b$$

$$X = (X_{n-1}X_{n-2} \cdots X_0)_b$$

$$Y = (Y_{n-1}Y_{n-2} \cdots Y_0)_b$$

$$M = (M_{n-1}M_{n-2} \cdots M_0)_b$$

$$\bar{r} = (\bar{r}_{n-1}\bar{r}_{n-2} \cdots \bar{r}_0)_b$$

Each of the  $n$  values in  $Z_{n-1} \sim Z_0$ ,  $X_{n-1} \sim X_0$ ,  $Y_{n-1} \sim Y_0$ ,  $M_{n-1} \sim M_0$ ,  $\bar{r}_{n-1} \sim \bar{r}_0$  represents one base- $b$  digit (a 32-bit word).

$Z_{n-1}$ ,  $X_{n-1}$ ,  $Y_{n-1}$ ,  $M_{n-1}$  and  $\bar{r}_{n-1}$  are the most significant bits of  $Z$ ,  $X$ ,  $Y$ ,  $M$ , while  $Z_0$ ,  $X_0$ ,  $Y_0$ ,  $M_0$  and  $\bar{r}_0$  are the least significant bits.

If we define

$$R = b^n$$

then, we can calculate the additional arguments, as follows:

$$\bar{r} = R^2 \bmod M \tag{1}$$

$$\begin{cases} M'' \times M + 1 = R \times R^{-1} \\ M' = M'' \bmod b \end{cases} \tag{2}$$

(Equation 2 is written in a form suitable for calculations using the extended binary GCD algorithm.)

Software can implement large-number modular exponentiations in the following order:

1. Write  $(\frac{N}{512} - 1)$  to RSA\_MODEXP\_MODE\_REG.
2. Write  $X_i$ ,  $Y_i$ ,  $M_i$  and  $\bar{r}_i$  ( $i \in [0, n) \cap \mathbb{N}$ ) to memory blocks RSA\_X\_MEM, RSA\_Y\_MEM, RSA\_M\_MEM and RSA\_Z\_MEM. The capacity of each memory block is 128 words. Each word of each memory block can store one base- $b$  digit. The memory blocks use the little endian format for storage, i.e. the least significant digit of each number is in the lowest address.

Users need to write data to each memory block only according to the length of the number; data beyond this length are ignored.

3. Write  $M'$  to RSA\_M\_PRIME\_REG.
4. Write 1 to RSA\_MODEXP\_START\_REG.
5. Wait for the operation to be completed. Poll RSA\_INTERRUPT\_REG until it reads 1, or until the RSA\_INTR interrupt is generated.
6. Read the result  $Z_i$  ( $i \in [0, n) \cap \mathbb{N}$ ) from RSA\_Z\_MEM.
7. Write 1 to RSA\_INTERRUPT\_REG to clear the interrupt.

After the operation, the RSA\_MODEXP\_MODE\_REG register, memory blocks RSA\_Y\_MEM and RSA\_M\_MEM, as well as the RSA\_M\_PRIME\_REG will not have changed. However,  $X_i$  in RSA\_X\_MEM and  $\bar{r}_i$  in RSA\_Z\_MEM will have been overwritten. In order to perform another operation, refresh the registers and memory blocks, as required.

### 24.3.3 Large Number Modular Multiplication

Large-number modular multiplication performs  $Z = X \times Y \bmod M$ . This operation is based on Montgomery multiplication. The same values  $\bar{r}$  and  $M'$  are derived by software using the formulas 1 and 2 shown above.

The RSA Accelerator supports large-number modular multiplication with eight different operand lengths, which are the same as in the large-number modular exponentiation. The operation is performed by a combination of software and hardware. The software performs two hardware operations in sequence.

The software process is as follows:

1. Write  $(\frac{N}{512} - 1)$  to RSA\_MULT\_MODE\_REG.
2. Write  $X_i$ ,  $M_i$  and  $\bar{r}_i$  ( $i \in [0, n) \cap \mathbb{N}$ ) to registers RSA\_X\_MEM, RSA\_M\_MEM and RSA\_Z\_MEM. Write data to each memory block only according to the length of the number. Data beyond this length are ignored.
3. Write  $M'$  to RSA\_M\_PRIME\_REG.
4. Write 1 to RSA\_MULT\_START\_REG.
5. Wait for the first round of the operation to be completed. Poll RSA\_INTERRUPT\_REG until it reads 1, or until the RSA\_INTR interrupt is generated.
6. Write 1 to RSA\_INTERRUPT\_REG to clear the interrupt.
7. Write  $Y_i$  ( $i \in [0, n) \cap \mathbb{N}$ ) to RSA\_X\_MEM.

Users need to write to the memory block only according to the length of the number. Data beyond this length are ignored.

8. Write 1 to RSA\_MULT\_START\_REG.
9. Wait for the second round of the operation to be completed. Poll RSA\_INTERRUPT\_REG until it reads 1, or until the RSA\_INTR interrupt is generated.
10. Read the result  $Z_i$  ( $i \in [0, n) \cap \mathbb{N}$ ) from RSA\_Z\_MEM.
11. Write 1 to RSA\_INTERRUPT\_REG to clear the interrupt.

After the operation, the RSA\_MULT\_MODE\_REG register, and memory blocks RSA\_M\_MEM and RSA\_M\_PRIME\_REG remain unchanged. Users do not need to refresh these registers or memory blocks if the values remain the same.

### 24.3.4 Large Number Multiplication

Large-number multiplication performs  $Z = X \times Y$ . The length of  $Z$  is twice that of  $X$  and  $Y$ . Therefore, the RSA Accelerator supports large-number multiplication with only four operand lengths of  $N \in \{512, 1024, 1536, 2048\}$  bits. The length  $\hat{N}$  of the result  $Z$  is  $2 \times N$  bits.

Operands  $X$  and  $Y$  need to be extended to form arguments  $\hat{X}$  and  $\hat{Y}$  which have the same length ( $\hat{N}$  bits) as the

result  $Z$ .  $X$  is left-extended and  $Y$  is right-extended, and defined as follows:

$$n = \frac{N}{32}$$

$$\hat{N} = 2 \times N$$

$$\hat{n} = \frac{\hat{N}}{32} = 2n$$

$$\hat{X} = (\hat{X}_{\hat{n}-1} \hat{X}_{\hat{n}-2} \cdots \hat{X}_0)_b = (\underbrace{00 \cdots 0}_n X)_b = (\underbrace{00 \cdots 0}_n X_{n-1} X_{n-2} \cdots X_0)_b$$

$$\hat{Y} = (\hat{Y}_{\hat{n}-1} \hat{Y}_{\hat{n}-2} \cdots \hat{Y}_0)_b = (Y \underbrace{00 \cdots 0}_n)_b = (Y_{n-1} Y_{n-2} \cdots Y_0 \underbrace{00 \cdots 0}_n)_b$$

Software performs the operation in the following order:

1. Write  $(\frac{\hat{N}}{512} - 1 + 8)$  to `RSA_MULT_MODE_REG`.
2. Write  $\hat{X}_i$  and  $\hat{Y}_i$  ( $i \in [0, \hat{n}) \cap \mathbb{N}$ ) to `RSA_X_MEM` and `RSA_Z_MEM`, respectively.  
Write the valid data into each number's memory block, according to their lengths. Values beyond this length are ignored. Half of the base- $b$  positional notations written to the memory are zero (using the derivations shown above). These zero values are indispensable.
3. Write 1 to `RSA_MULT_START_REG`.
4. Wait for the operation to be completed. Poll `RSA_INTERRUPT_REG` until it reads 1, or until the `RSA_INTR` interrupt is generated.
5. Read the result  $Z_i$  ( $i \in [0, \hat{n}) \cap \mathbb{N}$ ) from `RSA_Z_MEM`.
6. Write 1 to `RSA_INTERRUPT_REG` to clear the interrupt.

After the operation, only the `RSA_MULT_MODE_REG` register remains unmodified.

## 24.4 Register Summary

Name	Description	Address	Access
<b>Configuration registers</b>			
<a href="#">RSA_M_PRIME_REG</a>	Register to store $M'$	0x3FF02800	R/W
<b>Modular exponentiation registers</b>			
<a href="#">RSA_MODEXP_MODE_REG</a>	Modular exponentiation mode	0x3FF02804	R/W
<a href="#">RSA_MODEXP_START_REG</a>	Start bit	0x3FF02808	WO
<b>Modular multiplication registers</b>			
<a href="#">RSA_MULT_MODE_REG</a>	Modular multiplication mode	0x3FF0280C	R/W
<a href="#">RSA_MULT_START_REG</a>	Start bit	0x3FF02810	WO
<b>Misc registers</b>			
<a href="#">RSA_INTERRUPT_REG</a>	RSA interrupt register	0x3FF02814	R/W
<a href="#">RSA_CLEAN_REG</a>	RSA clean register	0x3FF02818	RO

## 24.5 Registers

**Register 24.1. RSA\_M\_PRIME\_REG (0x800)**

31	0
0x00000000	
Reset	

**RSA\_M\_PRIME\_REG** This register contains M'. (R/W)

**Register 24.2. RSA\_MODEXP\_MODE\_REG (0x804)**

31	3	2	0
<i>(reserved)</i>			<i>RSA_MODEXP_MODE</i>
0 0			0 0 0
Reset			

**RSA\_MODEXP\_MODE** This register contains the mode of modular exponentiation. (R/W)

**Register 24.3. RSA\_MODEXP\_START\_REG (0x808)**

31	1	0
<i>(reserved)</i>		<i>RSA_MODEXP_START</i>
0 0		0
Reset		

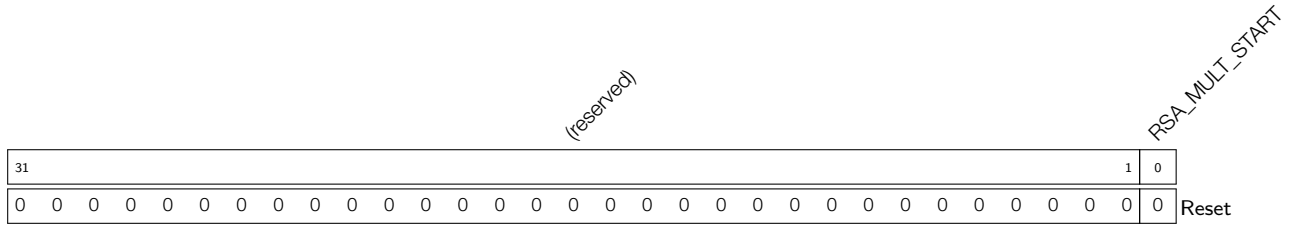
**RSA\_MODEXP\_START** Write 1 to start modular exponentiation. (WO)

**Register 24.4. RSA\_MULT\_MODE\_REG (0x80C)**

31	4	3	0
<i>(reserved)</i>			<i>RSA_MULT_MODE</i>
0 0			0 0 0 0
Reset			

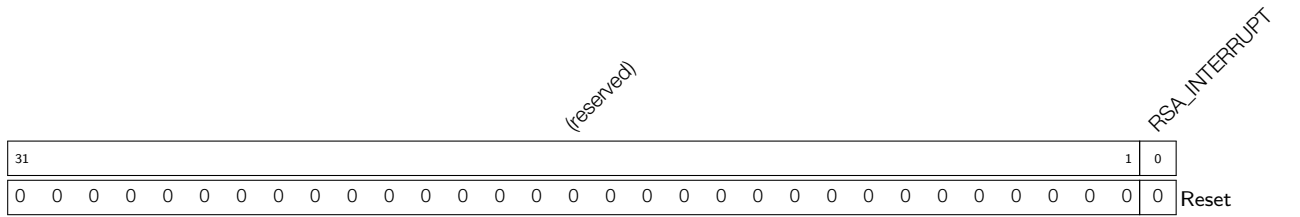
**RSA\_MULT\_MODE** This register contains the mode of modular multiplication and multiplication. (R/W)

**Register 24.5. RSA\_MULT\_START\_REG (0x810)**



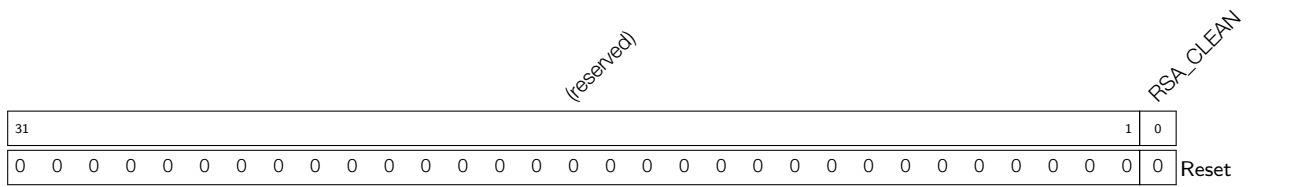
**RSA\_MULT\_START** Write 1 to start modular multiplication or multiplication. (WO)

**Register 24.6. RSA\_INTERRUPT\_REG (0x814)**



**RSA\_INTERRUPT** RSA interrupt status register. Will read 1 once an operation has completed. (R/W)

**Register 24.7. RSA\_CLEAN\_REG (0x818)**



**RSA\_CLEAN** This bit will read 1 once the memory initialization is completed. (RO)

## 25 Random Number Generator (RNG)

### 25.1 Introduction

The ESP32 contains a true random number generator, which generates 32-bit random numbers that can be used for cryptographical operations, among other things.

### 25.2 Feature

The random number generator generates true random numbers, which means random number generated from a physical process, rather than by means of an algorithm. No number generated within the specified range is more or less likely to appear than any other number.

### 25.3 Functional Description

Every 32-bit value that the system reads from the `RNG_DATA_REG` register of the random number generator is a true random number. These true random numbers are generated based on the thermal noise in the system and the asynchronous clock mismatch.

Thermal noise comes from the high-speed ADC or SAR ADC or both. Whenever the high-speed ADC or SAR ADC is enabled, bit streams will be generated and fed into the random number generator through an XOR logic gate as random seeds.

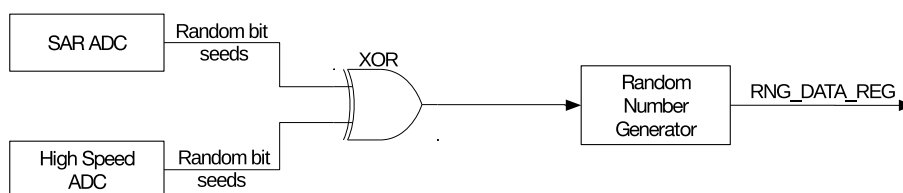


Figure 25-1. Noise Source

When there is noise coming from the SAR ADC, the random number generator is fed with a 2-bit entropy in one clock cycle of `RTC8M_CLK` (8 MHz), which is generated from an internal RC oscillator (see Chapter [Reset and Clock](#) for details). Thus, it is advisable to read the `RNG_DATA_REG` register at a maximum rate of 500 kHz to obtain the maximum entropy.

When there is noise coming from the high-speed ADC, the random number generator is fed with a 2-bit entropy in one APB clock cycle, which is normally 80 MHz. Thus, it is advisable to read the `RNG_DATA_REG` register at a maximum rate of 5 MHz to obtain the maximum entropy.

A data sample of 2 GB, which is read from the random number generator at a rate of 5 MHz with only the high-speed ADC being enabled, has been tested using the Dieharder Random Number Test suite (version 3.31.1). The sample passed all tests.

## 25.4 Programming Procedure

When using the random number generator, make sure at least either the SAR ADC or high-speed ADC is enabled. Otherwise, pseudo-random numbers will be returned.

- SAR ADC can be enabled by using the DIG ADC controller. For details, please refer to Chapter [29 On-Chip Sensors and Analog Signal Processing](#).
- High-speed ADC is enabled automatically when the Wi-Fi or Bluetooth modules is enabled.

**Note:**

Note that, when the Wi-Fi module is enabled, the value read from the high-speed ADC can be saturated in some extreme cases, which lowers the entropy. Thus, it is advisable to also enable the SAR ADC as the noise source for the random number generator for such cases.

When using the random number generator, read the [RNG\\_DATA\\_REG](#) register multiple times until sufficient random numbers have been generated. Ensure the rate at which the register is read does not exceed the frequencies described in section [25.3](#) above.

## 25.5 Register Summary

Name	Description	Address	Access
<a href="#">RNG_DATA_REG</a>	Random number data	0x3FF75144	RO

## 25.6 Register

**Register 25.1. RNG\_DATA\_REG (0x144)**

31	0
0x00000000	
Reset	

**RNG\_DATA\_REG** Random number source. (RO)

## 26 External Memory Encryption and Decryption (FLASH)

### 26.1 Overview

Many variants of the ESP32 must store programs and data in external flash memory. The external flash memory chip is likely to contain proprietary firmware and sensitive user data, such as credentials for gaining access to a private network. The Flash Encryption block can encrypt code and write encrypted code to off-chip flash memory for enhanced hardware security. When the CPU reads off-chip flash through the cache, the Flash Decryption block can automatically decrypt instructions and data read from the off-chip flash, thus providing hardware-based security for application code.

### 26.2 Features

- Various key generation methods
- Software-based encryption
- High-speed, hardware decryption
- Register configuration, system parameters and boot mode jointly determine the flash encryption/decryption function.

### 26.3 Functional Description

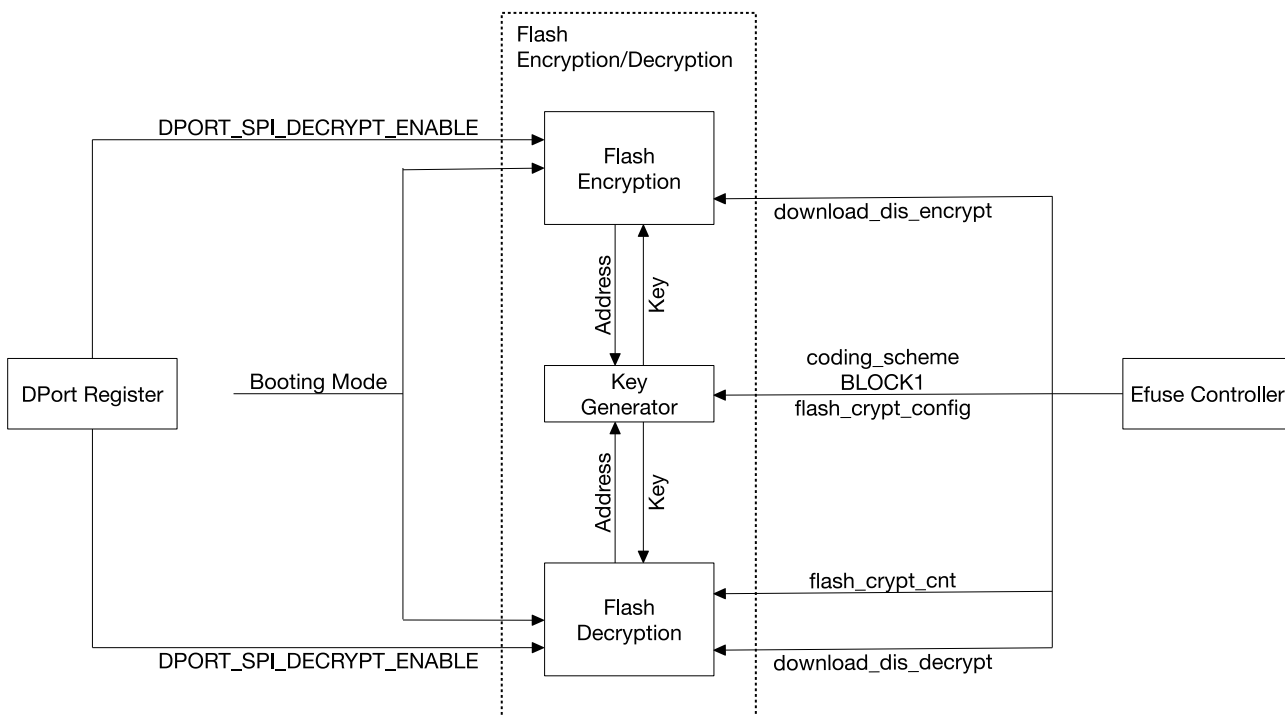


Figure 26-1. Flash Encryption/Decryption Module Architecture

The Flash Encryption/Decryption module consists of three parts, namely the Key Generator, Flash Encryption block and Flash Decryption block. The structure of these parts is shown in Figure 26-1. The Key Generator is shared by both the Flash Encryption block and the Flash Decryption block, which can function simultaneously.

In the peripheral DPort Register, the register relevant to Flash Encryption/Decryption is `DPORT_SPI_ENCRYPT_ENABLE`



bit and DPORT\_SPI\_DECRYPT\_ENABLE bit in DPORT\_SLAVE\_SPI\_CONFIG\_REG. The Flash Encryption/Decryption module will fetch six system parameters from the peripheral eFuse Controller. These parameters are: coding\_scheme, BLOCK1, flash\_crypt\_config, download\_dis\_encrypt, flash\_crypt\_cnt, and download\_dis\_decrypt.

### 26.3.1 Key Generator

According to system parameters coding\_scheme and BLOCK1, the Key Generator will first generate

$$Key_o = f(\text{coding\_scheme}, \text{BLOCK1}).$$

Then, according to system parameter flash\_crypt\_config, and off-chip flash physical addresses  $Addr_e$  and  $Addr_d$  accessed by the Flash Encryption block and the Flash Decryption block, the Key Generator will respectively figure out that:

$$Key_e = g(Key_o, \text{flash\_crypt\_config}, Addr_e),$$

$$Key_d = g(Key_o, \text{flash\_crypt\_config}, Addr_d).$$

When all values of system parameter flash\_crypt\_config are 0,  $Key_e$  and  $Key_d$  are not relevant to the physical address of the off-chip flash. When all values of system parameter flash\_crypt\_config are not 0, every 8-word block on the off-chip flash has a dedicated  $Key_e$  and  $Key_d$ .

### 26.3.2 Flash Encryption Block

The Flash Encryption block is equipped with registers that can be accessed by the CPU directly. Registers embedded in the Flash Encryption block, registers in the peripheral DPort Register, system parameters and Boot Mode jointly configure and control this block.

The Flash Encryption block requires software intervention during operation. The steps are as follows:

1. Set the DPORT\_SPI\_ENCRYPT\_ENABLE bit of register DPORT\_SLAVE\_SPI\_CONFIG\_REG.
2. Write the physical address prepared for the off-chip flash on register FLASH\_ENCRYPT\_ADDRESS\_REG. The address must be 8-word boundary aligned.
3. The Flash Encryption block must encrypt 8-word long code segments. Write the lowest word to register FLASH\_ENCRYPT\_BUFFER\_0\_REG, the second-lowest word into FLASH\_ENCRYPT\_BUFFER\_1\_REG, and so on, up to FLASH\_ENCRYPT\_BUFFER\_7\_REG.
4. Set the FLASH\_START bit in FLASH\_ENCRYPT\_START\_REG.
5. Wait for the FLASH\_DONE bit to be set in FLASH\_ENCRYPT\_DONE\_REG.
6. Use this function and write any 8-word code to the 8-word aligned address on the off-chip flash via the peripheral SPI0.

In Steps 1 to 5, the Flash Encryption block encrypts 8-word long codes. The key encryption algorithm uses  $Key_e$ . The encryption result will also be 8-word long. In Step 6, the peripheral SPI0 writes encrypted results of the Flash Encryption block to the off-chip flash. One parameter of the function used in Step 6 will be the physical address of the off-chip flash. The physical address must be 8-word boundary aligned. Also, the value must be the same as the value written into register FLASH\_ENCRYPT\_ADDRESS\_REG during Step 2. Even though the function used in Step 6 still has a parameter with an 8-word long code, the parameter will be meaningless if Steps 1 to 5 are executed. The Peripheral SPI0 will use the encrypted result instead. If the Flash Encryption block is not operating, or has not executed Steps 1 to 5, Step 6 will not use the encrypted result. Instead, the function parameter will be used.

Flash Encryption Operating Conditions:

- During SPI Flash Boot

If the DPORT\_SPI\_ENCRYPT\_ENABLE bit of register DPORT\_SLAVE\_SPI\_CONFIG\_REG is 1, the Flash Encryption block is operational. Otherwise, it is not.

- During Download Boot

If the DPORT\_SPI\_ENCRYPT\_ENABLE bit of register DPORT\_SLAVE\_SPI\_CONFIG\_REG is 1, and system parameter download\_dis\_encrypt is 0, the Flash Encryption block is operational. Otherwise, it is not.

Even though software participates in the whole process, it cannot directly read the encrypted codes. Instead, the encrypted codes are integrated into the off-chip flash. Even though the CPU can skip the cache and get the encrypted code directly by reading the off-chip flash, the software can by no means access  $Key_e$ .

### 26.3.3 Flash Decryption Block

Flash Decryption is not a conventional peripheral, and is not equipped with registers. Therefore, the CPU cannot directly access the Flash Decryption block. The Peripheral DPort Register, system parameters and Booting Mode jointly control and configure the Flash Decryption block.

When the Flash Decryption block is operating, the CPU will read instructions and data from the off-chip flash via the cache. The Flash Decryption block automatically decrypts the instructions and data in the cache. The entire decryption process does not need software intervention and is transparent to the cache. The decryption algorithm can decrypt the code that has been encrypted by the Flash Encryption block. Software cannot access the key algorithm  $Key_d$  used.

When the Flash Decryption block is not operating, it does not have any effect on the contents stored in the off-chip flash, be they encrypted or unencrypted. What the CPU reads via the cache is the original information stored in the off-chip flash.

Flash Encryption Operating Conditions:

- During SPI Flash Boot

In the efuse system parameter flash\_crypt\_cnt (7 bits wide), if the number of bits with value 1 is odd, the Flash Decryption block is operational. Otherwise, it is not.

- During Download Boot

If the DPORT\_SPI\_DECRYPT\_ENABLE bit in DPORT\_SLAVE\_SPI\_CONFIG\_REG is 1, and system parameter download\_dis\_decrypt is 0, the Flash Decryption block is operational. Otherwise, it is not.

## 26.4 Register Summary

Name	Description	Address	Access
<a href="#">FLASH_ENCRYPTION_BUFFER_0_REG</a>	Flash encryption buffer register 0	0x3FF5B000	WO
<a href="#">FLASH_ENCRYPTION_BUFFER_1_REG</a>	Flash encryption buffer register 1	0x3FF5B004	WO
<a href="#">FLASH_ENCRYPTION_BUFFER_2_REG</a>	Flash encryption buffer register 2	0x3FF5B008	WO
<a href="#">FLASH_ENCRYPTION_BUFFER_3_REG</a>	Flash encryption buffer register 3	0x3FF5B00C	WO
<a href="#">FLASH_ENCRYPTION_BUFFER_4_REG</a>	Flash encryption buffer register 4	0x3FF5B010	WO
<a href="#">FLASH_ENCRYPTION_BUFFER_5_REG</a>	Flash encryption buffer register 5	0x3FF5B014	WO
<a href="#">FLASH_ENCRYPTION_BUFFER_6_REG</a>	Flash encryption buffer register 6	0x3FF5B018	WO
<a href="#">FLASH_ENCRYPTION_BUFFER_7_REG</a>	Flash encryption buffer register 7	0x3FF5B01C	WO

Name	Description	Address	Access
<a href="#">FLASH_ENCRYPTION_START_REG</a>	Encrypt operation control register	0x3FF5B020	WO
<a href="#">FLASH_ENCRYPTION_ADDRESS_REG</a>	External flash address register	0x3FF5B024	WO
<a href="#">FLASH_ENCRYPTION_DONE_REG</a>	Encrypt operation status register	0x3FF5B028	RO

## 26.5 Register

Register 26.1. FLASH\_ENCRYPTION\_BUFFER\_n\_REG (n: 0-7) (0x0+4\*n)

31	0
0x00000000	
Reset	

**FLASH\_ENCRYPTION\_BUFFER\_n\_REG** Data buffers for encryption. (WO)

Register 26.2. FLASH\_ENCRYPTION\_START\_REG (0x020)

31	1	0
(reserved)		
FLASH_START		
0 0		0
Reset		

**FLASH\_START** Set this bit to start encryption operation on data buffer. (WO)

Register 26.3. FLASH\_ENCRYPTION\_ADDRESS\_REG (0x024)

31	0
0x00000000	
Reset	

**FLASH\_ENCRYPTION\_ADDRESS\_REG** The physical address on the off-chip flash must be 8-word boundary aligned. (WO)

Register 26.4. FLASH\_ENCRYPTION\_DONE\_REG (0x028)

31	1	0
(reserved)		
FLASH_DONE		
0 0		0
Reset		

**FLASH\_DONE** Set this bit when encryption operation is complete. (RO)

## 27 Memory Management and Protection Units (MMU, MPU)

### 27.1 Introduction

Every peripheral and memory section in the ESP32 is accessed through either an MMU (Memory Management Unit) or an MPU (Memory Protection Unit). An MPU can allow or disallow the access of an application to a memory range or peripheral, depending on what kind of permission the OS has given to that particular application. An MMU can perform the same operation, as well as a virtual-to-physical memory address translation. This can be used to map an internal or external memory range to a certain virtual memory area. These mappings can be application-specific. Therefore, each application can be adjusted and have the memory configuration that is necessary for it to run properly. To differentiate between the OS and applications, there are eight Process Identifiers (or PIDs) that each application, or OS, can run. Furthermore, each application, or OS, is equipped with their own sets of mappings and rights.

### 27.2 Features

- Eight processes in each of the PRO\_CPU and APP\_CPU
- MPU/MMU management of on-chip memories, off-chip memories, and peripherals, based on process ID
- On-chip memory management by MPU/MMU
- Off-chip memory management by MMU
- Peripheral management by MPU

### 27.3 Functional Description

#### 27.3.1 PID Controller

In the ESP32, a PID controller acts as an indicator that signals the MMU/MPU the owner PID of the code that is currently running. The intention is that the OS updates the PID in the PID controller every time it switches context to another application. The PID controller can detect interrupts and automatically switch PIDs to that of the OS, if so configured.

There are two peripheral PID controllers in the system, one for each of the two CPUs in the ESP32. Having a PID controller per CPU allows running different processes on different CPUs, if so desired.

#### 27.3.2 MPU/MMU

The MPU and MMU manage on-chip memories, off-chip memories, and peripherals. To do this they are based on the process of accessing the peripheral or memory region. More specifically, when a code tries to access a MMU/MPU-protected memory region or peripheral, the MMU or MPU will receive the PID from the PID generator that is associated with the CPU on which the process is running.

For on-chip memory and peripherals, the decisions the MMU and MPU make are only based on this PID, whereas the specific CPU the code is running on is not taken into account. Subsequently, the MMU/MPU configuration for the internal memory and peripherals allows entries only for the eight different PIDs. In contrast, the MMU moderating access to the external memory takes not only the PID into account, but also the CPU the request is coming from. This means that MMUs have configuration options for every PID when running on the APP\_CPU, as well as every PID when running on the PRO\_CPU. While, in practice, accesses from both CPUs will be configured to have the same result for a specific process, doing so is not a hardware requirement.

The decision an MPU can make, based on this information, is to allow or deny a process to access the memory region or peripheral. An MMU has the same function, but additionally it redirects the virtual memory access, which the process acquired, into a physical memory access that can possibly reach out an entirely different physical memory region. This way, MMU-governed memory can be remapped on a process-by-process basis.

### 27.3.2.1 Embedded Memory

The on-chip memory is governed by fixed-function MPUs, configurable MPUs, and MMUs:

**Table 27-1. MPU and MMU Structure for Internal Memory**

Name	Size	Address range		Governed by
		From	To	
ROM0	384 KB	0x4000_0000	0x4005_FFFF	Static MPU
ROM1	64 KB	0x3FF9_0000	0x3FF9_FFFF	Static MPU
SRAM0	64 KB	0x4007_0000	0x4007_FFFF	Static MPU
	128 KB	0x4008_0000	0x4009_FFFF	SRAM0 MMU
SRAM1 (aliases)	128 KB	0x3FFE_0000	0x3FFF_FFFF	Static MPU
	128 KB	0x400A_0000	0x400B_FFFF	Static MPU
	32 KB	0x4000_0000	0x4000_7FFF	Static MPU
SRAM2	72 KB	0x3FFA_E000	0x3FFB_FFFF	Static MPU
	128 KB	0x3FFC_0000	0x3FFD_FFFF	SRAM2 MMU
RTC FAST (aliases)	8 KB	0x3FF8_0000	0x3FF8_1FFF	RTC FAST MPU
	8 KB	0x400C_0000	0x400C_1FFF	RTC FAST MPU
RTC SLOW	8 KB	0x5000_0000	0x5000_1FFF	RTC SLOW MPU

#### Static MPUs

ROM0, ROM1, the lower 64 KB of SRAM0, SRAM1 and the lower 72 KB of SRAM2 are governed by a static MPU. The behaviour of these MPUs are hardwired and cannot be configured by software. They moderate access to the memory region solely through the PID of the current process. When the PID of the process is 0 or 1, the memory can be read (and written when it is RAM) using the addresses specified in Table 27-1. When it is 2 ~ 7, the memory cannot be accessed.

#### RTC FAST & RTC SLOW MPU

The 8 KB RTC FAST Memory as well as the 8 KB of RTC SLOW Memory are governed by two configurable MPUs. The MPUs can be configured to allow or deny access to each individual PID, using the RTC\_CNTL\_RTC\_PID\_CONFIG\_REG and DPORT\_AHBLITE\_MPU\_TABLE\_RTC\_REG registers. Setting a bit in these registers will allow the corresponding PID to read or write from the memory; clearing the bit disallows access. Access for PID 0 and 1 to RTC SLOW memory cannot be configured and is always enabled. Table 27-2 and 27-3 define the bit-to-PID mappings of the registers.

**Table 27-2. MPU for RTC FAST Memory**

Size	Boundary address		Authority
	Low	High	PID RTC_CNTL_RTC_PID_CONFIG bit
8 KB	0x3FF8_0000	0x3FF8_1FFF	0 1 2 3 4 5 6 7
8 KB	0x400C_0000	0x400C_1FFF	0 1 2 3 4 5 6 7

**Table 27-3. MPU for RTC SLOW Memory**

Size	Boundary address		Authority	
	Low	High	PID = 0/1	PID DPORT_AHBLITE_MPU_TABLE_RTC_REG bit
8 KB	0x5000_0000	0x5000_1FFF	Read/Write	2 3 4 5 6 7 0 1 2 3 4 5

Register RTC\_CNTL\_RTC\_PID\_CONFIG\_REG is part of the RTC peripheral and can only be modified by processes with a PID of 0; register DPORT\_AHBLITE\_MPU\_TABLE\_RTC\_REG is a Dport register and can be changed by processes with a PID of 0 or 1.

### SRAM0 and SRAM2 upper 128 KB MMUs

Both the upper 128 KB of SRAM0 and the upper 128 KB of SRAM2 are governed by an MMU. Not only can these MMUs allow or deny access to the memory they govern (just like the MPUs do), but they are also capable of translating the address a CPU reads from or writes to (which is a virtual address) to a possibly different address in memory (the physical address).

In order to accomplish this, the internal RAM MMUs divide the memory range they govern into 16 pages. The page size is configurable as 8 KB, 4 KB and 2 KB. When the page size is 8 KB, the 16 pages span the entire 128 KB memory region; when the page size is 4 KB or 2 KB, a non-MMU-covered region of 64 or 96 KB, respectively, will exist at the end of the memory space. Similar to the virtual and physical addresses, it is also possible to imagine the pages as having a virtual and physical component. The MMU can convert an address within a virtual page to an address within a physical page.

For PID 0 and 1, this mapping is 1-to-1, meaning that a read from or write to a certain virtual page will always be converted to a read from or write to the exact same physical page. This allows an operating system, running under PID 0 and/or 1, to always have access to the entire physical memory range.

For PID 2 to 7, however, every virtual page can be reconfigured, on a per-PID basis, to map to a different physical page. This way, reads and writes to an offset within a virtual page get translated into reads and writes to the same offset within a different physical page. This is illustrated in Figure 27-1: the CPU (running a process with a PID between 2 to 7) tries to access memory address 0x3FFC\_2345. This address is within the virtual Page 1 memory region, at offset 0x0345. The MMU is instructed that for this particular PID, it should translate an access to virtual page 1 into physical Page 2. This causes the memory access to be redirected to the same offset as the virtual memory access, yet in Page 2, which results in the effective access of physical memory address 0x3FFC\_4345. The page size in this example is 8 KB.

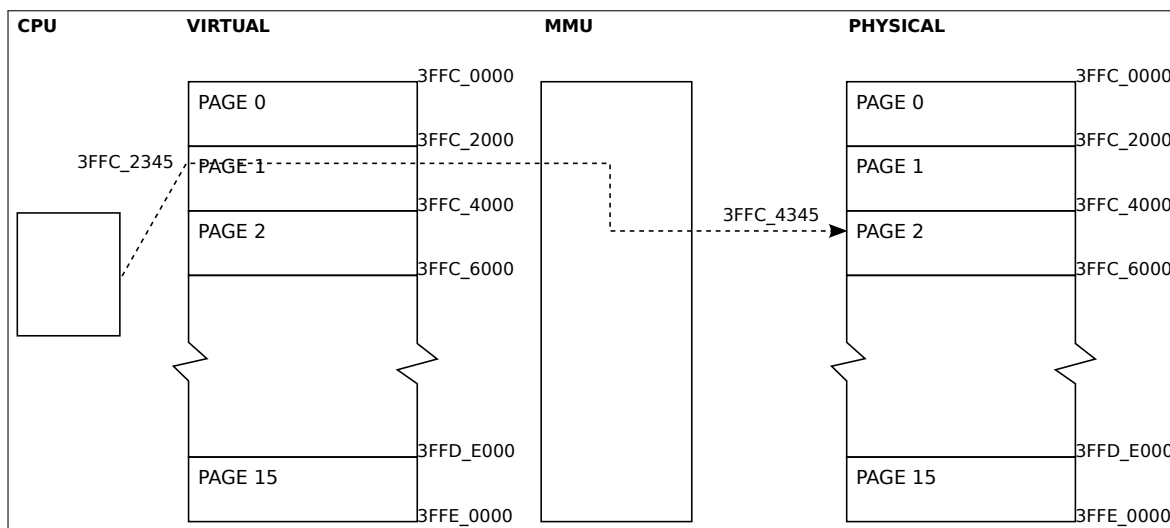


Figure 27-1. MMU Access Example

Table 27-4. Page Mode of MMU for the Remaining 128 KB of Internal SRAM0 and SRAM2

DPORT_IMMU_PAGE_MODE	DPORT_DMMU_PAGE_MODE	Page size
0	0	8 KB
1	1	4 KB
2	2	2 KB

### Non-MMU Governed Memory

For the MMU-managed region of SRAM0 and SRAM2, the page size is configurable as 8 KB, 4 KB and 2 KB. The configuration is done by setting the DPORT\_IMMU\_PAGE\_MODE (for SRAM0) and DPORT\_DMMU\_PAGE\_MODE (for SRAM2) bits in registers DPORT\_IMMU\_PAGE\_MODE\_REG and DPORT\_DMMU\_PAGE\_MODE\_REG, as detailed in Table 27-4. Because the number of pages for either region is fixed at 16, the total amount of memory covered by these pages is 128 KB when 8 KB pages are selected, 64 KB when 4 KB pages are selected, and 32 KB when 2 KB pages are selected. This implies that for 8 KB pages, the entire MMU-managed range is used, but for the other page sizes there will be a part of the 128 KB memory that will not be governed by the MMU settings. Concretely, for a page size of 4 KB, these regions are 0x4009\_0000 to 0x4009\_FFFF and 0x3FFD\_0000 to 0x3FFD\_FFFF; for a page size of 2 KB, the regions are 0x4008\_8000 to 0x4009\_FFFF and 0x3FFC\_8000 to 0x3FFD\_FFFF. These ranges are readable and writable by processes with a PID of 0 or 1; processes with other PIDs cannot access this memory.

The layout of the pages in memory space is linear, namely, an SRAM0 MMU page  $n$  covers address space  $0x40080000 + (pagesize * n)$  to  $0x40080000 + (pagesize * (n + 1) - 1)$ ; similarly, an SRAM2 MMU page  $n$  covers  $0x3FFC0000 + (pagesize * n)$  to  $0x3FFC0000 + (pagesize * (n + 1) - 1)$ . Tables 27-5 and 27-6 show the resulting addresses in full.



**Table 27-5. Page Boundaries for SRAM0 MMU**

Page	8 KB Pages		4 KB Pages		2 KB Pages	
	Bottom	Top	Bottom	Top	Bottom	Top
0	40080000	40081FFF	40080000	40080FFF	40080000	400807FF
1	40082000	40083FFF	40081000	40081FFF	40080800	40080FFF
2	40084000	40085FFF	40082000	40082FFF	40081000	400817FF
3	40086000	40087FFF	40083000	40083FFF	40081800	40081FFF
4	40088000	40089FFF	40084000	40084FFF	40082000	400827FF
5	4008A000	4008BFFF	40085000	40085FFF	40082800	40082FFF
6	4008C000	4008DFFF	40086000	40086FFF	40083000	400837FF
7	4008E000	4008FFFF	40087000	40087FFF	40083800	40083FFF
8	40090000	40091FFF	40088000	40088FFF	40084000	400847FF
9	40092000	40093FFF	40089000	40089FFF	40084800	40084FFF
10	40094000	40095FFF	4008A000	4008AFFF	40085000	400857FF
11	40096000	40097FFF	4008B000	4008BFFF	40085800	40085FFF
12	40098000	40099FFF	4008C000	4008CFFF	40086000	400867FF
13	4009A000	4009BFFF	4008D000	4008DFFF	40086800	40086FFF
14	4009C000	4009DFFF	4008E000	4008EFFF	40087000	400877FF
15	4009E000	4009FFFF	4008F000	4008FFFF	40087800	40087FFF
Rest	-	-	40090000	4009FFFF	4008800	4009FFFF

**Table 27-6. Page Boundaries for SRAM2 MMU**

Page	8 KB Pages		4 KB Pages		2 KB Pages	
	Bottom	Top	Bottom	Top	Bottom	Top
0	3FFC0000	3FFC1FFF	3FFC0000	3FFC0FFF	3FFC0000	3FFC07FF
1	3FFC2000	3FFC3FFF	3FFC1000	3FFC1FFF	3FFC0800	3FFC0FFF
2	3FFC4000	3FFC5FFF	3FFC2000	3FFC2FFF	3FFC1000	3FFC17FF
3	3FFC6000	3FFC7FFF	3FFC3000	3FFC3FFF	3FFC1800	3FFC1FFF
4	3FFC8000	3FFC9FFF	3FFC4000	3FFC4FFF	3FFC2000	3FFC27FF
5	3FFCA000	3FFCBFFF	3FFC5000	3FFC5FFF	3FFC2800	3FFC2FFF
6	3FFCC000	3FFCDFFF	3FFC6000	3FFC6FFF	3FFC3000	3FFC37FF
7	3FFCE000	3FFCFFFF	3FFC7000	3FFC7FFF	3FFC3800	3FFC3FFF
8	3FFD0000	3FFD1FFF	3FFC8000	3FFC8FFF	3FFC4000	3FFC47FF
9	3FFD2000	3FFD3FFF	3FFC9000	3FFC9FFF	3FFC4800	3FFC4FFF
10	3FFD4000	3FFD5FFF	3FFCA000	3FFCAFFF	3FFC5000	3FFC57FF
11	3FFD6000	3FFD7FFF	3FFCB000	3FFCBFFF	3FFC5800	3FFC5FFF
12	3FFD8000	3FFD9FFF	3FFCC000	3FFCCFFF	3FFC6000	3FFC67FF
13	3FFDA000	3FFDBFFF	3FFCD000	3FFCDFFF	3FFC6800	3FFC6FFF
14	3FFDC000	3FFDDFFF	3FFCE000	3FFCEFFF	3FFC7000	3FFC77FF
15	3FFDE000	3FFDFFFF	3FFCF000	3FFCFFFF	3FFC7800	3FFC7FFF
Rest	-	-	3FFD0000	3FFDFFFF	3FFC8000	3FFDFFFF

## MMU Mapping

For each of the SRAM0 and SRAM2 MMUs, access rights and virtual to physical page mapping are done by a set of 16 registers. In contrast to most of the other MMUs, each register controls a **physical** page, not a virtual one. These registers control which of the PIDs have access to the physical memory, as well as which virtual page maps to this physical page. The bits in the register are described in Table 27-7. Keep in mind that these registers only govern accesses from processes with PID 2 to 7; PID 0 and 1 always have full read and write access to all pages and no virtual-to-physical mapping is done. In other words, if a process with a PID of 0 or 1 accesses virtual page  $x$ , the access will always go to physical page  $x$ , regardless of these register settings. These registers, as well as the page size selection registers DPORT\_IMMU\_PAGE\_MODE\_REG and DPORT\_DMMU\_PAGE\_MODE\_REG, are only writable from a process with PID 0 or 1.

**Table 27-7. DPORT\_DMMU\_TABLE $n$ \_REG & DPORT\_IMMU\_TABLE $n$ \_REG**

[6:4]	Access rights for PID 2 ~ 7	[3:0]	Address authority
0	None of PIDs 2 ~ 7 have access.	0x00	Virtual page 0 accesses this physical page.
1	All of PIDs 2 ~ 7 have access.	0x01	Virtual page 1 accesses this physical page.
2	Only PID 2 has access.	0x02	Virtual page 2 accesses this physical page.
3	Only PID 3 has access.	0x03	Virtual page 3 accesses this physical page.
4	Only PID 4 has access.	0x04	Virtual page 4 accesses this physical page.
5	Only PID 5 has access.	0x05	Virtual page 5 accesses this physical page.
6	Only PID 6 has access.	0x06	Virtual page 6 accesses this physical page.
7	Only PID 7 has access.	0x07	Virtual page 7 accesses this physical page.
		0x08	Virtual page 8 accesses this physical page.
		0x09	Virtual page 9 accesses this physical page.
		0x10	Virtual page 10 accesses this physical page.
		0x11	Virtual page 11 accesses this physical page.
		0x12	Virtual page 12 accesses this physical page.
		0x13	Virtual page 13 accesses this physical page.
		0x14	Virtual page 14 accesses this physical page.
		0x15	Virtual page 15 accesses this physical page.

## Differences Between SRAM0 and SRAM2 MMU

The memory governed by the SRAM0 MMU is accessed through the processor's I-bus, while the processor accesses the memory governed by the SRAM2 MMU through the D-bus. Thus, the normal envisioned use is for the code to be stored in the SRAM0 MMU pages and data in the MMU pages of SRAM2. In general, applications running under a PID of 2 to 7 are not expected to modify their own code, because for these PIDs access to the MMU pages of SRAM0 is read-only. These applications must, however, be able to modify their data section, so that they are allowed to read as well as write MMU pages located in SRAM2. As stated before, processes running under PID 0 or 1 always have full read-and-write access to both memory ranges.

## DMA MPU

Applications may want to configure the DMA to send data straight from or to the peripherals they can control. With access to DMA, a malicious process may also be able to copy data from or to a region it cannot normally access. In order to be secure against that scenario, there is a DMA MPU which can be used to disallow DMA transfers

from memory regions with sensitive data in them.

For each 8 KB region in the SRAM1 and SRAM2 regions, there is a bit in the DPORT\_AHB\_MPU\_TABLE\_0\_REG registers which tells the MPU to either allow or disallow DMA access to this region. The DMA MPU uses only these bits to decide if a DMA transfer can be started; the PID of the process is not a factor. This means that when the OS wants to restrict its processes in a heterogenous fashion, it will need to re-load these registers with the values applicable to the process to be run on every context switch.

The register bits that govern access to the 8 KB regions are detailed in Table 27-8. When a register bit is set, DMA can read/write the corresponding 8 KB memory range. When the bit is cleared, access to that memory range is denied.

**Table 27-8. MPU for DMA**

Size	Boundary address		Authority	
	Low	High	Register	Bit
Internal SRAM 2				
8 KB	0x3FFA_E000	0x3FFA_FFFF	DPORT_AHB_MPU_TABLE_0_REG	0
8 KB	0x3FFB_0000	0x3FFB_1FFF	DPORT_AHB_MPU_TABLE_0_REG	1
8 KB	0x3FFB_2000	0x3FFB_3FFF	DPORT_AHB_MPU_TABLE_0_REG	2
8 KB	0x3FFB_4000	0x3FFB_5FFF	DPORT_AHB_MPU_TABLE_0_REG	3
8 KB	0x3FFB_6000	0x3FFB_7FFF	DPORT_AHB_MPU_TABLE_0_REG	4
8 KB	0x3FFB_8000	0x3FFB_9FFF	DPORT_AHB_MPU_TABLE_0_REG	5
8 KB	0x3FFB_A000	0x3FFB_BFFF	DPORT_AHB_MPU_TABLE_0_REG	6
8 KB	0x3FFB_C000	0x3FFB_DFFF	DPORT_AHB_MPU_TABLE_0_REG	7
8 KB	0x3FFB_E000	0x3FFB_FFFF	DPORT_AHB_MPU_TABLE_0_REG	8
8 KB	0x3FFC_0000	0x3FFC_1FFF	DPORT_AHB_MPU_TABLE_0_REG	9
8 KB	0x3FFC_2000	0x3FFC_3FFF	DPORT_AHB_MPU_TABLE_0_REG	10
8 KB	0x3FFC_4000	0x3FFC_5FFF	DPORT_AHB_MPU_TABLE_0_REG	11
8 KB	0x3FFC_6000	0x3FFC_7FFF	DPORT_AHB_MPU_TABLE_0_REG	12
8 KB	0x3FFC_8000	0x3FFC_9FFF	DPORT_AHB_MPU_TABLE_0_REG	13
8 KB	0x3FFC_A000	0x3FFC_BFFF	DPORT_AHB_MPU_TABLE_0_REG	14
8 KB	0x3FFC_C000	0x3FFC_DFFF	DPORT_AHB_MPU_TABLE_0_REG	15
8 KB	0x3FFC_E000	0x3FFC_FFFF	DPORT_AHB_MPU_TABLE_0_REG	16
8 KB	0x3FFD_0000	0x3FFD_1FFF	DPORT_AHB_MPU_TABLE_0_REG	17
8 KB	0x3FFD_2000	0x3FFD_3FFF	DPORT_AHB_MPU_TABLE_0_REG	18
8 KB	0x3FFD_4000	0x3FFD_5FFF	DPORT_AHB_MPU_TABLE_0_REG	19
8 KB	0x3FFD_6000	0x3FFD_7FFF	DPORT_AHB_MPU_TABLE_0_REG	20
8 KB	0x3FFD_8000	0x3FFD_9FFF	DPORT_AHB_MPU_TABLE_0_REG	21
8 KB	0x3FFD_A000	0x3FFD_BFFF	DPORT_AHB_MPU_TABLE_0_REG	22
8 KB	0x3FFD_C000	0x3FFD_DFFF	DPORT_AHB_MPU_TABLE_0_REG	23
8 KB	0x3FFD_E000	0x3FFD_FFFF	DPORT_AHB_MPU_TABLE_0_REG	24
Internal SRAM 1				
8 KB	0x3FFE_0000	0x3FFE_1FFF	DPORT_AHB_MPU_TABLE_0_REG	25
8 KB	0x3FFE_2000	0x3FFE_3FFF	DPORT_AHB_MPU_TABLE_0_REG	26
8 KB	0x3FFE_4000	0x3FFE_5FFF	DPORT_AHB_MPU_TABLE_0_REG	27
8 KB	0x3FFE_6000	0x3FFE_7FFF	DPORT_AHB_MPU_TABLE_0_REG	28

Size	Boundary address		Authority	
	Low	High	Register	Bit
8 KB	0x3FFE_8000	0x3FFE_9FFF	DPORT_AHB_MPU_TABLE_0_REG	29
8 KB	0x3FFE_A000	0x3FFE_BFFF	DPORT_AHB_MPU_TABLE_0_REG	30
8 KB	0x3FFE_C000	0x3FFE_DFFF	DPORT_AHB_MPU_TABLE_0_REG	31
8 KB	0x3FFE_E000	0x3FFE_FFFF	DPORT_AHB_MPU_TABLE_1_REG	0
8 KB	0x3FFF_0000	0x3FFF_1FFF	DPORT_AHB_MPU_TABLE_1_REG	1
8 KB	0x3FFF_2000	0x3FFF_3FFF	DPORT_AHB_MPU_TABLE_1_REG	2
8 KB	0x3FFF_4000	0x3FFF_5FFF	DPORT_AHB_MPU_TABLE_1_REG	3
8 KB	0x3FFF_6000	0x3FFF_7FFF	DPORT_AHB_MPU_TABLE_1_REG	4
8 KB	0x3FFF_8000	0x3FFF_9FFF	DPORT_AHB_MPU_TABLE_1_REG	5
8 KB	0x3FFF_A000	0x3FFF_BFFF	DPORT_AHB_MPU_TABLE_1_REG	6
8 KB	0x3FFF_C000	0x3FFF_DFFF	DPORT_AHB_MPU_TABLE_1_REG	7
8 KB	0x3FFF_E000	0x3FFF_FFFF	DPORT_AHB_MPU_TABLE_1_REG	8

Registers DPROT\_AHB\_MPU\_TABLE\_0\_REG DPROT\_AHB\_MPU\_TABLE\_1\_REG are located in the DPort address space. Only processes with a PID of 0 or 1 can modify these two registers.

**Note:**

In hardware, there are three instruction buses corresponding to  $VAddr_1$ ,  $VAddr_2$ , and  $VAddr_3$ , respectively. These three buses can initiate load or fetch accesses simultaneously, but only one access is true. If more than one unmasked instruction buses are present, then bit8 of all MMU entries should be set to zero. Otherwise, when an invalid MMU entry is used by an access, the cache will be stalled even if there is no program at this access.

### 27.3.2.2 External Memory

Accesses to the external flash and external SPI RAM are done through a cache and are also handled by an MMU. This Cache MMU can apply different mappings, depending on the PID of the process as well as the CPU the process is running on. The MMU does this in a way that is similar to the internal memory MMU, that is, for every page of virtual memory, it has a register detailing which physical page this virtual page should map to. There are differences between the MMUs governing the internal memory and the Cache MMU, though. First of all, the Cache MMU has a fixed page size (which is 64 KB for external flash and 32 KB for external RAM) and secondly, instead of specifying access rights in the MMU entries, the Cache MMU has explicit mapping tables for each PID and processor core. The MMU mapping configuration registers will be referred to as 'entries' in the rest of this chapter. These registers are only accessible from processes with a PID of 0 or 1; processes with a PID of 2 to 7 will have to delegate to one of the above-mentioned processes to change their MMU settings.

The MMU entries, as stated before, are used for mapping a virtual memory page access to a physical memory page access. The MMU controls five regions of virtual address space, detailed in Table 27-9.  $VAddr_1$  to  $VAddr_4$  are used for accessing external flash, whereas  $VAddr_{RAM}$  is used for accessing external RAM. Note that  $VAddr_4$  is a subset of  $VAddr_0$ .

**Table 27-9. Virtual Address for External Memory**

Name	Size	Boundary address		Page quantity
		Low	High	
<i>VAddr</i> <sub>0</sub>	4 MB	0x3F40_0000	0x3F7F_FFFF	64
<i>VAddr</i> <sub>1</sub>	4 MB	0x4000_0000	0x403F_FFFF	64*
<i>VAddr</i> <sub>2</sub>	4 MB	0x4040_0000	0x407F_FFFF	64
<i>VAddr</i> <sub>3</sub>	4 MB	0x4080_0000	0x40BF_FFFF	64
<i>VAddr</i> <sub>4</sub>	1 MB	0x3F40_0000	0x3F4F_FFFF	16
<i>VAddr</i> <sub>RAM</sub>	4 MB	0x3F80_0000	0x3FBF_FFFF	128

\* The configuration entries for address range 0x4000\_0000 ~ 0x403F\_FFFF are implemented and documented as if it were a full 4 MB address range, but it is not accessible as such. Instead, the address range 0x4000\_0000 ~ 0x400C\_1FFF accesses on-chip memory. This means that some of the configuration entries for *VAddr*<sub>1</sub> will not be used.

### External Flash

For flash, the relationships among entry numbers, virtual memory ranges, and PIDs are detailed in Tables 27-10 and 27-11, which for every memory region and PID combination specify the first MMU entry governing the mapping. This number refers to the MMU entry governing the very first page; the entire region is described by the amount of pages specified in the 'count' column.

These two tables are essentially the same, with the sole difference being that the APP\_CPU entry numbers are 2048 higher than the corresponding PRO\_CPU numbers. Note that memory regions *VAddr*<sub>0</sub> and *VAddr*<sub>1</sub> are only accessible using PID 0 and 1, while *VAddr*<sub>4</sub> can only be accessed by PID 2 ~ 7.

**Table 27-10. MMU Entry Numbers for PRO\_CPU**

VAddr	Count	First MMU entry for PID						
		0/1	2	3	4	5	6	7
<i>VAddr</i> <sub>0</sub>	64	0	-	-	-	-	-	-
<i>VAddr</i> <sub>1</sub>	64	64	-	-	-	-	-	-
<i>VAddr</i> <sub>2</sub>	64	128	256	384	512	640	768	896
<i>VAddr</i> <sub>3</sub>	64	192	320	448	576	704	832	960
<i>VAddr</i> <sub>4</sub>	16	-	1056	1072	1088	1104	1120	1136

**Table 27-11. MMU Entry Numbers for APP\_CPU**

VAddr	Count	First MMU entry for PID						
		0/1	2	3	4	5	6	7
<i>VAddr</i> <sub>0</sub>	64	2048	-	-	-	-	-	-
<i>VAddr</i> <sub>1</sub>	64	2112	-	-	-	-	-	-
<i>VAddr</i> <sub>2</sub>	64	2176	2304	2432	2560	2688	2816	2944
<i>VAddr</i> <sub>3</sub>	64	2240	2368	2496	2624	2752	2880	3008
<i>VAddr</i> <sub>4</sub>	16	-	3104	3120	3136	3152	3168	3184

As these tables show, virtual address *VAddr*<sub>1</sub> can only be used by processes with a PID of 0 or 1. There is

a special mode to allow processes with a PID of 2 to 7 to read the External Flash via address  $VAddr_1$ . When the `DPORT_PRO_SINGLE_IRAM_ENA` bit of register `DPORT_PRO_CACHE_CTRL_REG` is 1, the MMU enters this special mode for `PRO_CPU` memory accesses. Similarly, when the `DPORT_APP_SINGLE_IRAM_ENA` bit of register `DPORT_APP_CACHE_CTRL_REG` is 1, the `APP_CPU` accesses memory using this special mode. In this mode, the process and virtual address page supported by each configuration entry of MMU are different. For details please see Table 27-12 and 27-13. As shown in these tables, in this special mode  $VAddr_2$  and  $VAddr_3$  cannot be used to access External Flash.

**Table 27-12. MMU Entry Numbers for PRO\_CPU (Special Mode)**

VAddr	Count	First MMU entry for PID						
		0/1	2	3	4	5	6	7
$VAddr_0$	64	0	-	-	-	-	-	-
$VAddr_1$	64	64	256	384	512	640	768	896
$VAddr_2$	64	-	-	-	-	-	-	-
$VAddr_3$	64	-	-	-	-	-	-	-
$VAddr_4$	16	-	1056	1072	1088	1104	1120	1136

**Table 27-13. MMU Entry Numbers for APP\_CPU (Special Mode)**

VAddr	Count	First MMU entry for PID						
		0/1	2	3	4	5	6	7
$VAddr_0$	64	2048	-	-	-	-	-	-
$VAddr_1$	64	2112	2304	2432	2560	2688	2816	2944
$VAddr_2$	64	-	-	-	-	-	-	-
$VAddr_3$	64	-	-	-	-	-	-	-
$VAddr_4$	16	-	3104	3120	3136	3152	3168	3184

Every configuration entry of MMU maps a virtual address page of a CPU process to a physical address page. An entry is 32 bits wide. Of these, bits 0~7 indicate the physical page the virtual page is mapped to. Bit 8 should be cleared to indicate that the MMU entry is valid; entries with this bit set will not map any physical address to the virtual address. Bits 10 to 32 are unused and should be written as zero. Because there are eight address bits in an MMU entry, and the page size for external flash is 64 KB, a maximum of  $256 * 64 \text{ KB} = 16 \text{ MB}$  of external flash is supported.

## Examples

Example 1. A `PRO_CPU` process, with a PID of 1, needs to read external flash address `0x07_2375` via virtual address `0x3F70_2375`. The MMU is not in the special mode.

- According to Table 27-9, virtual address `0x3F70_2375` resides in the 0x30'th page of  $VAddr_0$ .
- According to Table 27-10, the MMU entry for  $VAddr_0$  for PID 0/1 for the `PRO_CPU` starts at 0.
- The modified MMU entry is  $0 + 0x30 = 0x30$ .
- Address `0x07_2375` resides in the 7'th 64 KB-sized page.
- MMU entry `0x30` needs to be set to 7 and marked as valid by setting the 8'th bit to 0. Thus, `0x007` is written to MMU entry `0x30`.

Example 2. An APP\_CPU process, with a PID of 4, needs to read external flash address 0x44\_048C via virtual address 0x4044\_048C. The MMU is not in special mode.

- According to Table 27-9, virtual address 0x4044\_048C resides in the 0x4'th page of  $VAddr_2$ .
- According to Table 27-11, the MMU entry for  $VAddr_2$  for PID 4 for the APP\_CPU starts at 2560.
- The modified MMU entry is  $2560 + 0x4 = 2564$ .
- Address 0x44\_048C resides in the 0x44'th 64 KB-sized page.
- MMU entry 2564 needs to be set to 0x44 and marked as valid by setting the 8'th bit to 0. Thus, 0x044 is written to MMU entry 2564.

## External RAM

Processes running on PRO\_CPU and APP\_CPU can read and write External SRAM via the Cache at virtual address range  $VAddr_{RAM}$ , which is 0x3F80\_0000 ~ 0x3FBF\_FFFF. As with the flash MMU, the address space and the physical memory are divided into pages. For the External RAM MMU, the page size is 32 KB and the MMU is able to map 256 physical pages into the virtual address space, allowing for  $32 \text{ KB} * 256 = 8 \text{ MB}$  of physical external RAM to be mapped.

The mapping of virtual pages into this memory range depends on the mode this MMU is in: Low-High mode, Even-Odd mode, or Normal mode. In all cases, the DPORT\_PRO\_DRAM\_HL bit and DPORT\_PRO\_DRAM\_SPLIT bit in register DPORT\_PRO\_CACHE\_CTRL\_REG, the DPORT\_APP\_DRAM\_HL bit and DPORT\_APP\_DRAM\_SPLIT bit in register DPORT\_APP\_CACHE\_CTRL\_REG determine the virtual address mode for External SRAM. For details, please see Table 27-14. If a different mapping for the PRO\_CPU and APP\_CPU is required, the Normal Mode should be selected, as it is the only mode that can provide this. If it is allowable for the PRO\_CPU and the APP\_CPU to share the same mapping, using either High-Low or Even-Odd mode can give a speed gain when both CPUs access memory frequently.

In case the APP\_CPU cache is disabled, which renders the region of 0x4007\_8000 to 0x4007\_FFFF usable as normal internal RAM, the usability of the various cache modes changes. Normal mode will allow PRO\_CPU access to external RAM to keep functioning, but the APP\_CPU will be unable to access the external RAM. High-Low mode allows both CPUs to use external RAM, but only for the 2 MB virtual memory addresses from 0x3F80\_0000 to 0x3F9F\_FFFF. It is not advised to use Even-Odd mode with the APP\_CPU cache region disabled.

**Table 27-14. Virtual Address Mode for External SRAM**

Mode	DPORT_PRO_DRAM_HL DPORT_APP_DRAM_HL	DPORT_PRO_DRAM_SPLIT DPORT_APP_DRAM_SPLIT
Low-High	1	0
Even-Odd	0	1
Normal	0	0

In normal mode, the virtual-to-physical page mapping can be different for both CPUs. Page mappings for PRO\_CPU are set using the MMU entries for  $^L VAddr_{RAM}$ , and page mappings for the APP\_CPU can be configured using the MMU entries for  $^R VAddr_{RAM}$ . In this mode, all 128 pages of both  $^L VAddr$  and  $^R VAddr$  are fully used, allowing a maximum of 8 MB of memory to be mapped; 4 MB into PRO\_CPU address space and a possibly different 4 MB into the APP\_CPU address space, as can be seen in Table 27-15.

**Table 27-15. Virtual Address for External SRAM ( Normal Mode )**

Virtual address	Size	PRO_CPU address	
		Low	High
${}^L V Addr_{RAM}$	4 MB	0x3F80_0000	0x3FBF_FFFF
Virtual address	Size	APP_CPU address	
		Low	High
${}^R V Addr_{RAM}$	4 MB	0x3F80_0000	0x3FBF_FFFF

In Low-High mode, both the PRO\_CPU and the APP\_CPU use the same mapping entries. In this mode  ${}^L V Addr_{RAM}$  is used for the lower 2 MB of the virtual address space, while  ${}^R V Addr_{RAM}$  is used for the upper 2 MB. This also means that the upper 64 MMU entries for  ${}^L V Addr_{RAM}$ , as well as the lower 64 entries for  ${}^R V Addr_{RAM}$ , are unused. Table 27-16 details these address ranges.

**Table 27-16. Virtual Address for External SRAM ( Low-High Mode )**

Virtual address	Size	PRO_CPU/APP_CPU address	
		Low	High
${}^L V Addr_{RAM}$	2 MB	0x3F80_0000	0x3F9F_FFFF
${}^R V Addr_{RAM}$	2 MB	0x3FA0_0000	0x3FBF_FFFF

In Even-Odd memory, the VRAM is split into 32-byte chunks. The even chunks are resolved through the MMU entries for  ${}^L V Addr_{RAM}$ , the odd chunks through the entries for  ${}^R V Addr_{RAM}$ . Generally, the MMU entries for  ${}^L V Addr_{RAM}$  and  ${}^R V Addr_{RAM}$  are set to the same values, so that the virtual pages map to a contiguous region of physical memory. Table 27-17 details this mode.

**Table 27-17. Virtual Address for External SRAM (Even-Odd Mode)**

Virtual address	Size	PRO_CPU/APP_CPU address	
		Low	High
${}^L V Addr_{RAM}$	32 Bytes	0x3F80_0000	0x3F80_001F
${}^R V Addr_{RAM}$	32 Bytes	0x3F80_0020	0x3F80_003F
${}^L V Addr_{RAM}$	32 Bytes	0x3F80_0040	0x3F80_005F
${}^R V Addr_{RAM}$	32 Bytes	0x3F80_0060	0x3F80_007F
...			
${}^L V Addr_{RAM}$	32 Bytes	0x3FBF_FFC0	0x3FBF_FFDF
${}^R V Addr_{RAM}$	32 Bytes	0x3FBF_FFE0	0x3FBF_FFFF

The bit configuration of the External RAM MMU entries is the same as for the flash memory: the entries are 32-bit registers, with the lower nine bits being used. Bits 0~7 contain the physical page the entry should map its associate virtual page address to, while bit 8 is cleared when the entry is valid and set when it is not. Table 27-18 details the first MMU entry number for  ${}^L V Addr_{RAM}$  and  ${}^R V Addr_{RAM}$  for all PIDs.



**Table 27-18. MMU Entry Numbers for External RAM**

VAddr	Count	First MMU entry for PID						
		0/1	2	3	4	5	6	7
${}^L VAddr_{RAM}$	128	1152	1280	1408	1536	1664	1792	1920
${}^R VAddr_{RAM}$	128	3200	3328	3456	3584	3712	3840	3968

### Examples

Example 1. A PRO\_CPU process, with a PID of 7, needs to read or write external RAM address 0x7F\_A375 via virtual address 0x3FA7\_2375. The MMU is in Low-High mode.

- According to Table 27-9, virtual address 0x3FA7\_2375 resides in the 0x4E'th 32-KB-page of  $VAddr_{RAM}$ .
- According to Table 27-16, virtual address 0x3FA7\_2375 is governed by  ${}^R VAddr_{RAM}$ .
- According to Table 27-18, the MMU entry for  ${}^R VAddr_{RAM}$  for PID 7 for the PRO\_CPU starts at 3968.
- The modified MMU entry is  $3968 + 0x4E = 4046$ .
- Address 0x7F\_A375 resides in the 255'th 32 KB-sized page.
- MMU entry 4046 needs to be set to 255 and marked as valid by clearing the 8'th bit. Thus, 0x0FF is written to MMU entry 4046.

Example 2. An APP\_CPU process, with a PID of 5, needs to read or write external RAM address 0x55\_5805 up to 0x55\_5823 starting at virtual address 0x3F85\_5805. The MMU is in Even-Odd mode.

- According to Table 27-9, virtual address 0x3F85\_5805 resides in the 0x0A'th 32-KB-page of  $VAddr_{RAM}$ .
- According to Table 27-17, the range to be read/written spans both a 32-byte region in  ${}^R VAddr_{RAM}$  and  ${}^L VAddr_{RAM}$ .
- According to Table 27-18, the MMU entry for  ${}^L VAddr_{RAM}$  for PID 5 starts at 1664.
- According to Table 27-18, the MMU entry for  ${}^R VAddr_{RAM}$  for PID 5 starts at 3712.
- The modified MMU entries are  $1664 + 0x0A = 1674$  and  $3712 + 0x0A = 3722$ .
- The addresses 0x55\_5805 to 0x55\_5823 reside in the 0xAA'th 32 KB-sized page.
- MMU entries 1674 and 3722 need to be set to 0xAA and marked as valid by setting the 8'th bit to 0. Thus, 0x0AA is written to MMU entries 1674 and 3722. This mapping applies to both the PRO\_CPU and the APP\_CPU.

Example 3. A PRO\_CPU process, with a PID of 1, and an APP\_CPU process whose PID is also 1, need to read or write external RAM using virtual address 0x3F80\_0876. The PRO\_CPU needs this region to access physical address 0x10\_0876, while the APP\_CPU wants to access physical address 0x20\_0876 through this virtual address. The MMU is in Normal mode.

- According to Table 27-9, virtual address 0x3F80\_0876 resides in the 0'th 32-KB-page of  $VAddr_{RAM}$ .
- According to Table 27-18, the MMU entry for PID 1 for the PRO\_CPU starts at 1152.
- According to Table 27-18, the MMU entry for PID 1 for the APP\_CPU starts at 3200.
- The MMU entries that are modified are  $1152 + 0 = 1152$  for the PRO\_CPU and  $3200 + 0 = 3200$  for the APP\_CPU.
- Address 0x10\_0876 resides in the 0x20'th 32 KB-sized page.
- Address 0x20\_0876 resides in the 0x40'th 32 KB-sized page.
- For the PRO\_CPU, MMU entry 1152 needs to be set to 0x20 and marked as valid by clearing the 8'th bit. Thus, 0x020 is written to MMU entry 1152.

- For the APP\_CPU, MMU entry 3200 needs to be set to 0x40 and marked as valid by clearing the 8'th bit. Thus, 0x040 is written to MMU entry 3200.
- Now, the PRO\_CPU and the APP\_CPU can access different physical memory regions through the same virtual address.

### 27.3.2.3 Peripheral

The Peripheral MPU manages the 39 peripheral modules. This MMU can be configured per peripheral to only allow access from a process with a certain PID. The registers to configure this are detailed in Table 27-19.

**Table 27-19. MPU for Peripheral**

Peripheral	Authority	
	PID = 0/1	PID = 2 ~ 7
DPort Register	Access	Forbidden
AES Accelerator	Access	Forbidden
RSA Accelerator	Access	Forbidden
SHA Accelerator	Access	Forbidden
Secure Boot	Access	Forbidden
Cache MMU Table	Access	Forbidden
PID Controller	Access	Forbidden
UART0	Access	DPORT_AHBLITE_MPU_TABLE_UART_REG
SPI1	Access	DPORT_AHBLITE_MPU_TABLE_SPI1_REG
SPI0	Access	DPORT_AHBLITE_MPU_TABLE_SPI0_REG
GPIO	Access	DPORT_AHBLITE_MPU_TABLE_GPIO_REG
RTC	Access	DPORT_AHBLITE_MPU_TABLE_RTC_REG
IO MUX	Access	DPORT_AHBLITE_MPU_TABLE_IO_MUX_REG
SDIO Slave	Access	DPORT_AHBLITE_MPU_TABLE_HINF_REG
UDMA1	Access	DPORT_AHBLITE_MPU_TABLE_UHCI1_REG
I2S0	Access	DPORT_AHBLITE_MPU_TABLE_I2S0_REG
UART1	Access	DPORT_AHBLITE_MPU_TABLE_UART1_REG
I2C0	Access	DPORT_AHBLITE_MPU_TABLE_I2C_EXT0_REG
UDMA0	Access	DPORT_AHBLITE_MPU_TABLE_UHCI0_REG
SDIO Slave	Access	DPORT_AHBLITE_MPU_TABLE_SLCHOST_REG
RMT	Access	DPORT_AHBLITE_MPU_TABLE_RMT_REG
PCNT	Access	DPORT_AHBLITE_MPU_TABLE_PCNT_REG
SDIO Slave	Access	DPORT_AHBLITE_MPU_TABLE_SLC_REG
LED PWM	Access	DPORT_AHBLITE_MPU_TABLE_LEDC_REG
Efuse Controller	Access	DPORT_AHBLITE_MPU_TABLE_EFUSE_REG
Flash Encryption	Access	DPORT_AHBLITE_MPU_TABLE_SPI_ENCRYPT_REG
PWM0	Access	DPORT_AHBLITE_MPU_TABLE_PWM0_REG
TIMG0	Access	DPORT_AHBLITE_MPU_TABLE_TIMERGROUP_REG
TIMG1	Access	DPORT_AHBLITE_MPU_TABLE_TIMERGROUP1_REG
SPI2	Access	DPORT_AHBLITE_MPU_TABLE_SPI2_REG
SPI3	Access	DPORT_AHBLITE_MPU_TABLE_SPI3_REG
SYSCON	Access	DPORT_AHBLITE_MPU_TABLE_APB_CTRL_REG

Peripheral	Authority	
	PID = 0/1	PID = 2 ~ 7
I2C1	Access	DPORT_AHBLITE_MPU_TABLE_I2C_EXT1_REG
SDMMC	Access	DPORT_AHBLITE_MPU_TABLE_SDIO_HOST_REG
EMAC	Access	DPORT_AHBLITE_MPU_TABLE_EMAC_REG
PWM1	Access	DPORT_AHBLITE_MPU_TABLE_PWM1_REG
I2S1	Access	DPORT_AHBLITE_MPU_TABLE_I2S1_REG
UART2	Access	DPORT_AHBLITE_MPU_TABLE_UART2_REG
RNG	Access	DPORT_AHBLITE_MPU_TABLE_PWR_REG

Each bit of register DPORT\_AHBLITE\_MPU\_TABLE\_X\_REG determines whether each process can access the peripherals managed by the register. For details please see Table 27-20. When a bit of register DPORT\_AHBLITE\_MPU\_TABLE\_X\_REG is 1, it means that a process with the corresponding PID can access the corresponding peripheral of the register. Otherwise, the process cannot access the corresponding peripheral.

**Table 27-20. DPORT\_AHBLITE\_MPU\_TABLE\_X\_REG**

PID	2 3 4 5 6 7
DPORT_AHBLITE_MPU_TABLE_X_REG bit	0 1 2 3 4 5

All the DPORT\_AHBLITE\_MPU\_TABLE\_X\_REG registers are in peripheral DPort Register. Only processes with PID 0/1 can modify these registers.

## 28 Process ID Controller (PID)

### 28.1 Overview

The ESP32 is a dual core device and is capable of running and managing multiple processes. The PID Controller supports switching of PID when a process switch occurs. In addition to PID management, the PID Controller also facilitates management of nested interrupts by recording execution status just before an interrupt service routine is executed. This enables the user application to manage process switches and nested interrupts more efficiently.

### 28.2 Features

The PID Controller features:

- Process management and priority
- Process PID switch
- Interrupt information recording
- Nested interrupt management

### 28.3 Functional Description

Eight processes run on the CPU, and are assigned with PID of 0 ~ 7 respectively. Among the eight processes, processes with PID of 0 or 1 are elevated processes with higher authority compared to processes with PID ranging from 2 ~ 7.

A CPU process switch may occur in two cases:

- An interrupt occurs and the CPU fetches an instruction from the interrupt vector. Instruction fetch or execution from interrupt vector is always treated as a process with PID of 0, irrespective of which process was being executed on the CPU when the interrupt occurred.
- A currently active process explicitly performs a process switch. Only elevated processes with PID of 0 or 1 may perform a process switch.

#### 28.3.1 Interrupt Identification

Interrupts are classified into seven priority levels: Level 1, Level 2, Level 3, Level 4, Level 5, Level 6 (Debug), and NMI. Each level of interrupt is assigned an interrupt vector entry address. The PID Controller recognizes CPU instruction fetch from an interrupt vector entry address and automatically switches PID to 0. If CPU only accesses the interrupt vector entry address, PID Controller performs no action.

[PIDCTRL\\_INTERRUPT\\_ENABLE\\_REG](#) determines whether the PID Controller identifies and registers an interrupt of certain priority. When a bit of register [PIDCTRL\\_INTERRUPT\\_ENABLE\\_REG](#) is 1, PID Controller will take action when CPU fetches instruction from the interrupt vector entry address of the corresponding interrupt. Otherwise, PID Controller performs no action. The registers [PIDCTRL\\_INTERRUPT\\_ADDR\\_1\\_REG](#) ~ [PIDCTRL\\_INTERRUPT\\_ADDR\\_7\\_REG](#) define the interrupt vector entry address for all the interrupt priority levels. For details please refer to Table [28-1](#).

**Table 28-1. Interrupt Vector Entry Address**

Priority level	PIDCTRL_INTERRUPT_ENABLE_REG bit controlling interrupt identification	Interrupt vector entry address
Level 1	1	<a href="#">PIDCTRL_INTERRUPT_ADDR_1_REG</a>
Level 2	2	<a href="#">PIDCTRL_INTERRUPT_ADDR_2_REG</a>
Level 3	3	<a href="#">PIDCTRL_INTERRUPT_ADDR_3_REG</a>
Level 4	4	<a href="#">PIDCTRL_INTERRUPT_ADDR_4_REG</a>
Level 5	5	<a href="#">PIDCTRL_INTERRUPT_ADDR_5_REG</a>
Level 6 ( Debug )	6	<a href="#">PIDCTRL_INTERRUPT_ADDR_6_REG</a>
NMI	7	<a href="#">PIDCTRL_INTERRUPT_ADDR_7_REG</a>

### 28.3.2 Information Recording

When PID Controller identifies an interrupt, it records three items of information in addition to switching PID to 0. The recorded information includes the priority level of current interrupt, previous interrupt status of the system and the previous process running on the CPU.

PID Controller records the priority level of the current interrupt in register [PIDCTRL\\_LEVEL\\_REG](#). For details please refer to Table [28-2](#).

**Table 28-2. Configuration of PIDCTRL\_LEVEL\_REG**

Value	Priority level of the current interrupt
0	No interrupt
1	Level 1
2	Level 2
3	Level 3
4	Level 4
5	Level 5
6	Level 6
7	NMI

PID Controller also records in register [PIDCTRL\\_FROM\\_n\\_REG](#) the status of the system before the interrupt occurred. The bit width of register [PIDCTRL\\_FROM\\_n\\_REG](#) is 7. The highest four bits represent the interrupt status of the system before the interrupt indicated by the register occurred. The lowest three bits represent the process running on the CPU before the interrupt indicated by the register occurred. For details please refer to Table [28-3](#).

**Table 28-3. Configuration of PIDCTRL\_FROM\_n\_REG**

[6:3]	Previous interrupt	[2:0]	Previous process
0	No interrupt	0	Process with PID of 0
1	Level 1 Interrupt	1	Process with PID of 1
2	Level 2 Interrupt	2	Process with PID of 2
3	Level 3 Interrupt	3	Process with PID of 3
4	Level 4 Interrupt	4	Process with PID of 4
5	Level 5 Interrupt	5	Process with PID of 5
6	Level 6 Interrupt	6	Process with PID of 6
7	Level 7 Interrupt	7	Process with PID of 7

PID Controller possesses registers PIDCTRL\_FROM\_1\_REG ~ PIDCTRL\_FROM\_7\_REG, which correspond to the interrupts of Level 1, Level 2, Level 3, Level 4, Level 5, Level 6 (Debug), and NMI respectively. This enables the system to implement interrupt nesting. Please refer to Table 28-1 for examples.

If the configuration of register [PIDCTRL\\_INTERRUPT\\_ENABLE\\_REG](#) prevents PID Controller from identifying an interrupt, PID Controller will not record any information, and [PIDCTRL\\_LEVEL\\_REG](#) and [PIDCTRL\\_FROM\\_n\\_REG](#) will remain unchanged.

### 28.3.3 Proactive Process Switching

As mentioned before, only an elevated process with PID of 0/1 can initiate a process switch. The new process may have any PID from 0 ~ 7 after the process switch. The key for successful proactive process switching is that when the last command of the current process switches to the first command of the new process, PID should switch from 0/1 to that of the new process.

The software procedure for proactive process switching is as follows:

1. Mask all the interrupts except NMI by using software.
2. Set register [PIDCTRL\\_NMI\\_MASK\\_ENABLE\\_REG](#) to 1 to generate a CPU NMI Interrupt Mask signal.
3. Configure registers [PIDCTRL\\_PID\\_DELAY\\_REG](#) and [PIDCTRL\\_NMI\\_DELAY\\_REG](#).
4. Configure register [PIDCTRL\\_PID\\_NEW\\_REG](#).
5. Configure register [PIDCTRL\\_LEVEL\\_REG](#) and [PIDCTRL\\_FROM\\_n\\_REG](#).
6. Set register [PIDCTRL\\_PID\\_CONFIRM\\_REG](#) and register [PIDCTRL\\_NMI\\_MASK\\_DISABLE\\_REG](#) to 1.
7. Revoke the masking of all interrupts but NMI.
8. Switch to the new process and fetch instruction.

Though we can deal with interrupt nesting, an elevated process should not be interrupted during the process switching, and therefore the interrupts have been masked in step 1 and step 2.

In step 3, the configured values of registers [PIDCTRL\\_PID\\_DELAY\\_REG](#) and [PIDCTRL\\_NMI\\_DELAY\\_REG](#) will affect step 6.

In step 4, the configured value of register [PIDCTRL\\_PID\\_NEW\\_REG](#) will be the new PID after step 6.

If the system is currently in a nested interrupt and needs to revert to the previous interrupt, register [PIDCTRL\\_LEVEL\\_REG](#) must be restored based on the information recorded in register [PIDCTRL\\_FROM\\_n\\_REG](#) in step 5.

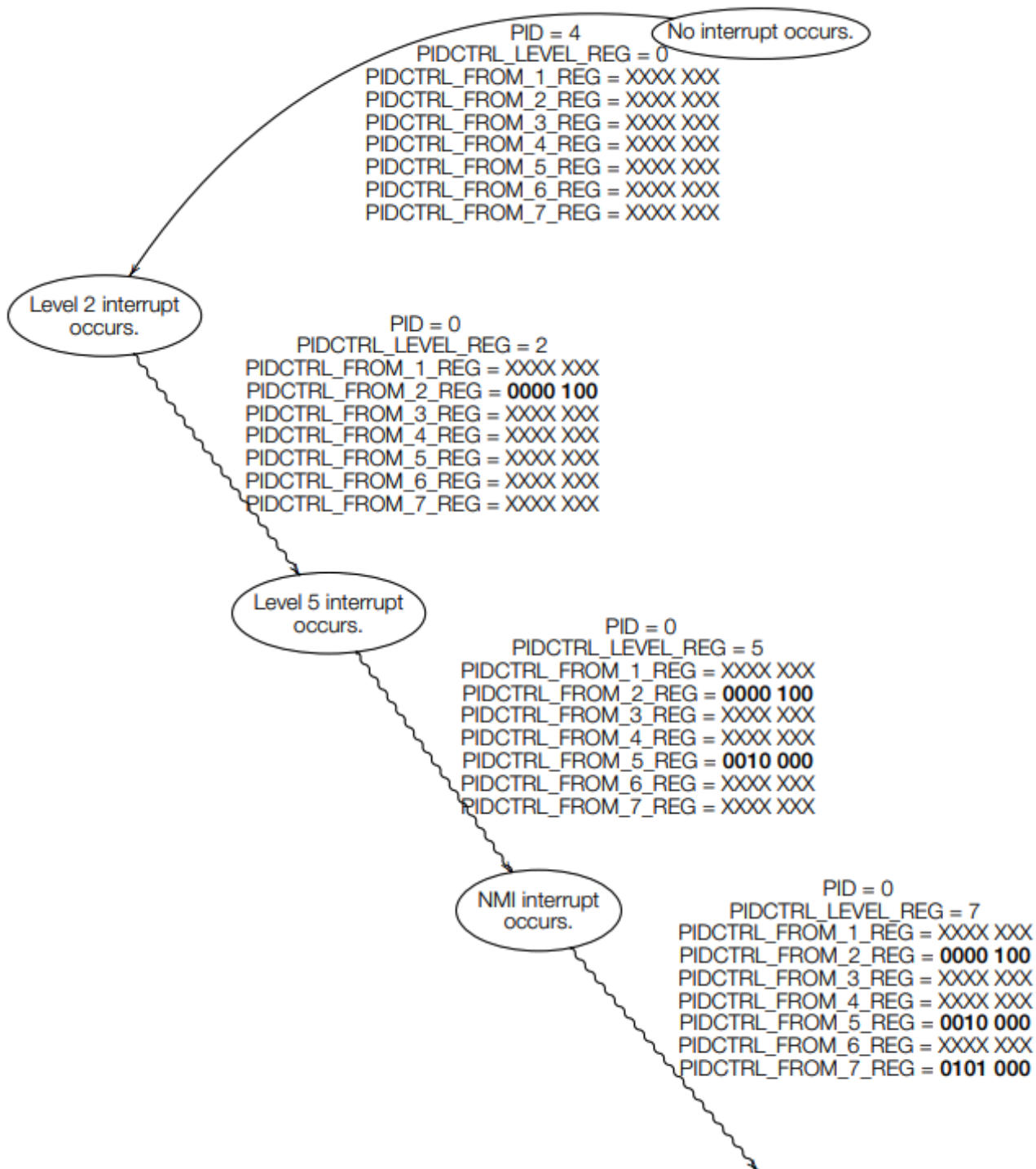


Figure 28-1. Interrupt Nesting

In step 6, after the values of register `PIDCTRL_PID_CONFIRM_REG` and register `PIDCTRL_NMI_MASK_DISABLE_REG` are set to 1, PID Controller will not immediately switch PID to the value of register `PIDCTRL_PID_NEW_REG`, nor disable CPU NMI Interrupt Mask signal at once. Instead, PID Controller performs each task after a different number of clock cycles. The numbers of clock cycles are the values specified in register `PIDCTRL_PID_DELAY_REG` and `PIDCTRL_NMI_DELAY_REG` respectively.

In step 7, other tasks can be implemented as well. To do this, the cost of those tasks should be included when configuring registers `PIDCTRL_PID_DELAY_REG` and `PIDCTRL_NMI_DELAY_REG` in step 3.

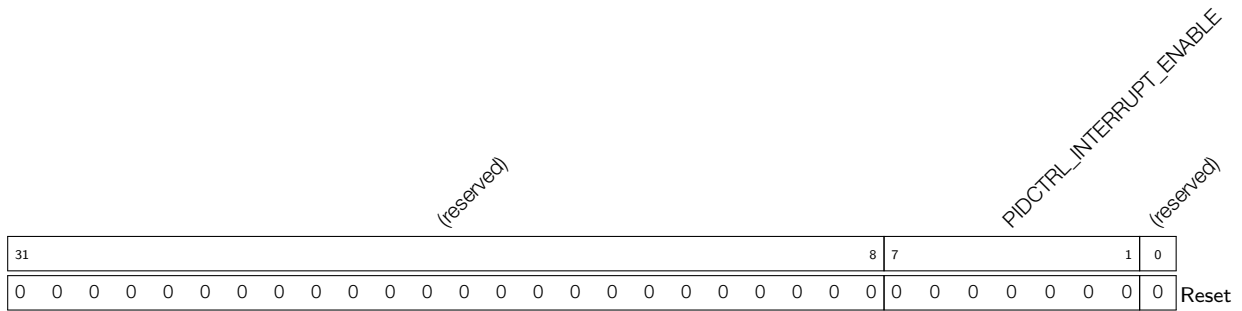
## 28.4 Register Summary

Name	Description	Address	Access
<a href="#">PIDCTRL_INTERRUPT_ENABLE_REG</a>	PID interrupt identification enable	0x3FF1F000	R/W
<a href="#">PIDCTRL_INTERRUPT_ADDR_1_REG</a>	Level 1 interrupt vector address	0x3FF1F004	R/W
<a href="#">PIDCTRL_INTERRUPT_ADDR_2_REG</a>	Level 2 interrupt vector address	0x3FF1F008	R/W
<a href="#">PIDCTRL_INTERRUPT_ADDR_3_REG</a>	Level 3 interrupt vector address	0x3FF1F00C	R/W
<a href="#">PIDCTRL_INTERRUPT_ADDR_4_REG</a>	Level 4 interrupt vector address	0x3FF1F010	R/W
<a href="#">PIDCTRL_INTERRUPT_ADDR_5_REG</a>	Level 5 interrupt vector address	0x3FF1F014	R/W
<a href="#">PIDCTRL_INTERRUPT_ADDR_6_REG</a>	Level 6 interrupt vector address	0x3FF1F018	R/W
<a href="#">PIDCTRL_INTERRUPT_ADDR_7_REG</a>	NMI interrupt vector address	0x3FF1F01C	R/W
<a href="#">PIDCTRL_PID_DELAY_REG</a>	New PID valid delay	0x3FF1F020	R/W
<a href="#">PIDCTRL_NMI_DELAY_REG</a>	NMI mask signal disable delay	0x3FF1F024	R/W
<a href="#">PIDCTRL_LEVEL_REG</a>	Current interrupt priority	0x3FF1F028	R/W
<a href="#">PIDCTRL_FROM_1_REG</a>	System status before Level 1 interrupt	0x3FF1F02C	R/W
<a href="#">PIDCTRL_FROM_2_REG</a>	System status before Level 2 interrupt	0x3FF1F030	R/W
<a href="#">PIDCTRL_FROM_3_REG</a>	System status before Level 3 interrupt	0x3FF1F034	R/W
<a href="#">PIDCTRL_FROM_4_REG</a>	System status before Level 4 interrupt	0x3FF1F038	R/W
<a href="#">PIDCTRL_FROM_5_REG</a>	System status before Level 5 interrupt	0x3FF1F03C	R/W
<a href="#">PIDCTRL_FROM_6_REG</a>	System status before Level 6 interrupt	0x3FF1F040	R/W
<a href="#">PIDCTRL_FROM_7_REG</a>	System status before NMI	0x3FF1F044	R/W
<a href="#">PIDCTRL_PID_NEW_REG</a>	New PID configuration register	0x3FF1F048	R/W
<a href="#">PIDCTRL_PID_CONFIRM_REG</a>	New PID confirmation register	0x3FF1F04C	WO
<a href="#">PIDCTRL_NMI_MASK_ENABLE_REG</a>	NMI mask enable register	0x3FF1F054	WO
<a href="#">PIDCTRL_NMI_MASK_DISABLE_REG</a>	NMI mask disable register	0x3FF1F058	WO



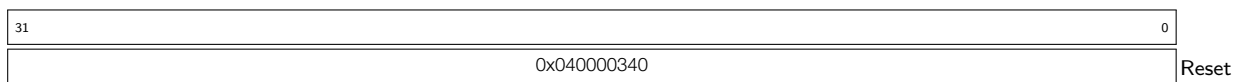
## 28.5 Registers

**Register 28.1. PIDCTRL\_INTERRUPT\_ENABLE\_REG (0x000)**



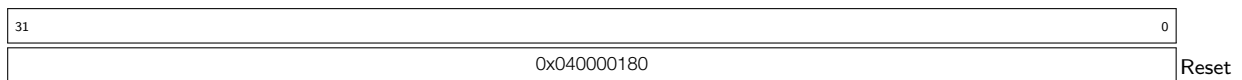
**PIDCTRL\_INTERRUPT\_ENABLE** These bits are used to enable interrupt identification and processing. (R/W)

**Register 28.2. PIDCTRL\_INTERRUPT\_ADDR\_1\_REG (0x004)**



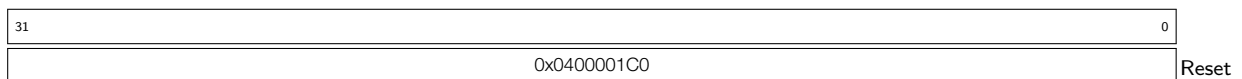
**PIDCTRL\_INTERRUPT\_ADDR\_1\_REG** Level 1 interrupt vector entry address. (R/W)

**Register 28.3. PIDCTRL\_INTERRUPT\_ADDR\_2\_REG (0x008)**



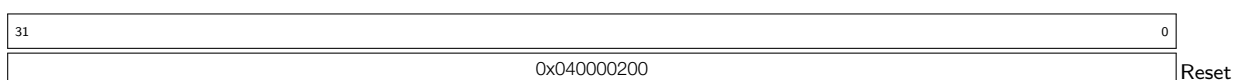
**PIDCTRL\_INTERRUPT\_ADDR\_2\_REG** Level 2 interrupt vector entry address. (R/W)

**Register 28.4. PIDCTRL\_INTERRUPT\_ADDR\_3\_REG (0x00C)**



**PIDCTRL\_INTERRUPT\_ADDR\_3\_REG** Level 3 interrupt vector entry address. (R/W)

**Register 28.5. PIDCTRL\_INTERRUPT\_ADDR\_4\_REG (0x010)**



**PIDCTRL\_INTERRUPT\_ADDR\_4\_REG** Level 4 interrupt vector entry address. (R/W)

**Register 28.6. PIDCTRL\_INTERRUPT\_ADDR\_5\_REG (0x014)**

31	0
0x040000240	
Reset	

**PIDCTRL\_INTERRUPT\_ADDR\_5\_REG** Level 5 interrupt vector entry address. (R/W)

**Register 28.7. PIDCTRL\_INTERRUPT\_ADDR\_6\_REG (0x018)**

31	0
0x040000280	
Reset	

**PIDCTRL\_INTERRUPT\_ADDR\_6\_REG** Level 6 interrupt vector entry address. (R/W)

**Register 28.8. PIDCTRL\_INTERRUPT\_ADDR\_7\_REG (0x01C)**

31	0
0x0400002C0	
Reset	

**PIDCTRL\_INTERRUPT\_ADDR\_7\_REG** NMI interrupt vector entry address. (R/W)

**Register 28.9. PIDCTRL\_PID\_DELAY\_REG (0x020)**

31	(reserved)	12	11	0
		PIDCTRL_PID_DELAY		
0 0				20
Reset				

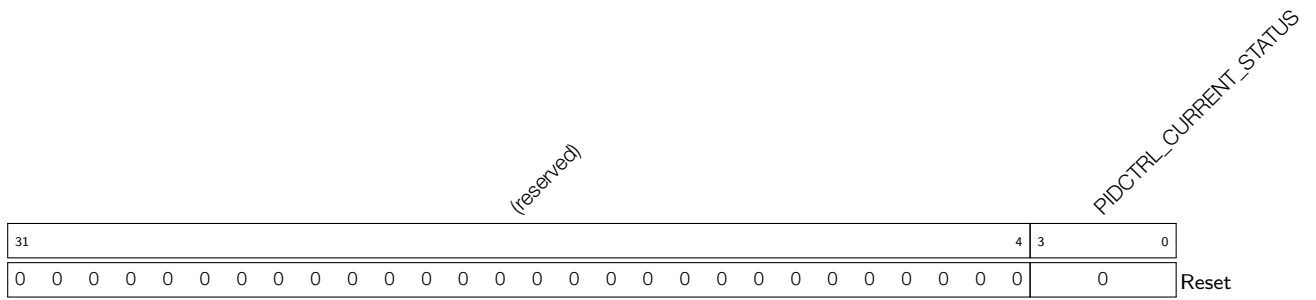
**PIDCTRL\_PID\_DELAY** Delay until newly assigned PID is valid. (R/W)

**Register 28.10. PIDCTRL\_NMI\_DELAY\_REG (0x024)**

31	(reserved)	12	11	0
		PIDCTRL_NMI_DELAY		
0 0				16
Reset				

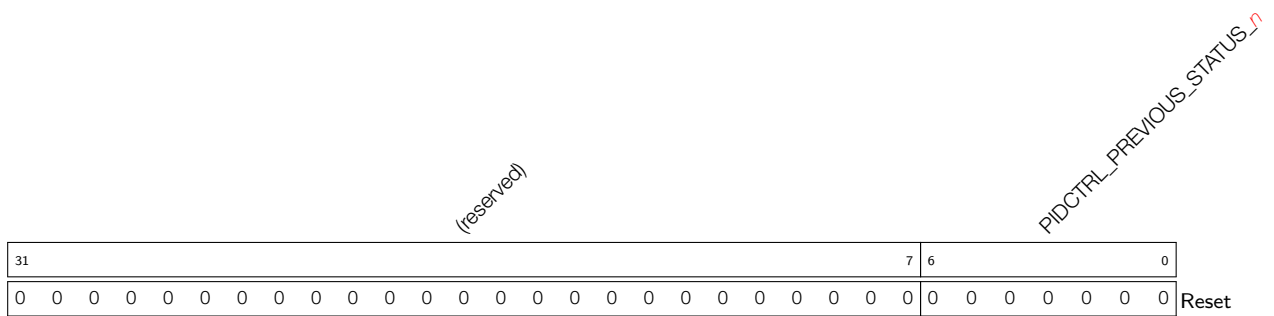
**PIDCTRL\_NMI\_DELAY** Delay for disabling CPU NMI interrupt mask signal. (R/W)

**Register 28.11. PIDCTRL\_LEVEL\_REG (0x028)**



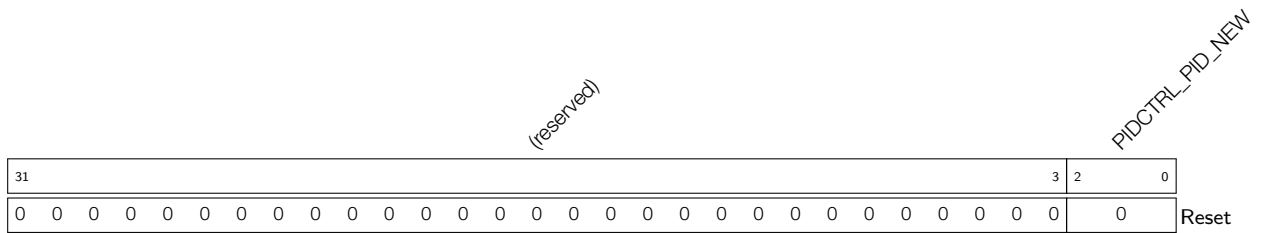
**PIDCTRL\_CURRENT\_STATUS** The current status of the system. (R/W)

**Register 28.12. PIDCTRL\_FROM\_n\_REG (n: 1-7) (0x28+0x4\*n)**



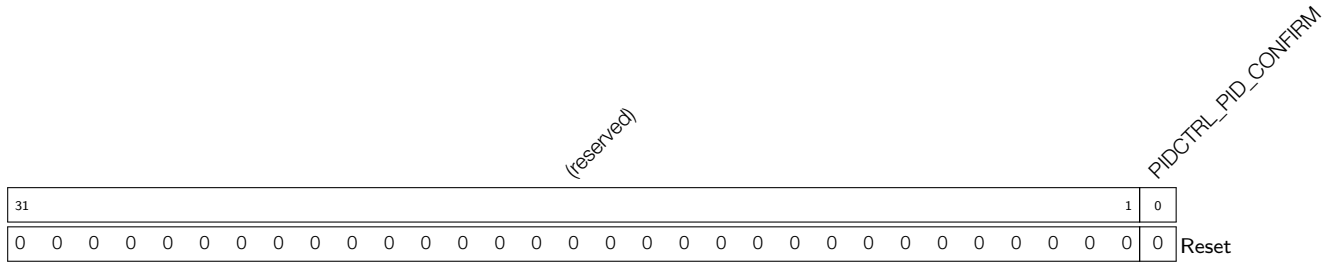
**PIDCTRL\_PREVIOUS\_STATUS\_n** System status before any of Level 1 to Level 6, NMI interrupts occurs. (R/W)

**Register 28.13. PIDCTRL\_PID\_NEW\_REG (0x048)**



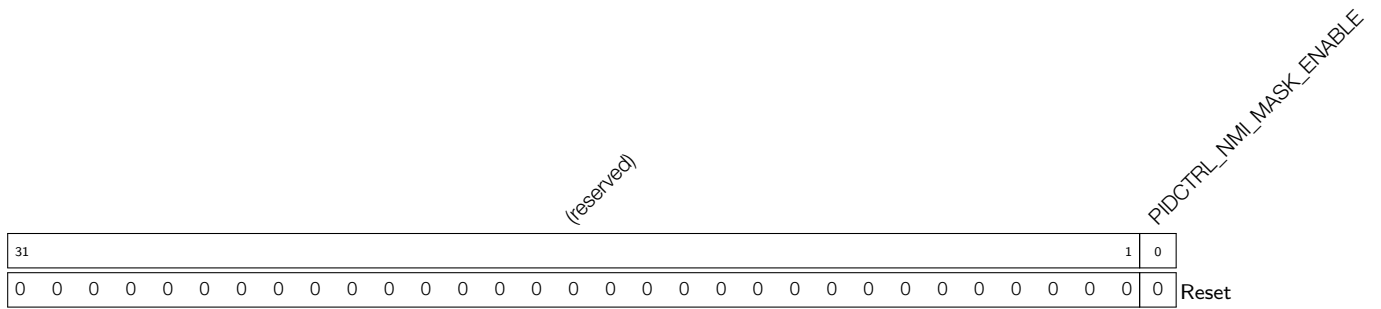
**PIDCTRL\_PID\_NEW** New PID. (R/W)

**Register 28.14. PIDCTRL\_PID\_CONFIRM\_REG (0x04C)**



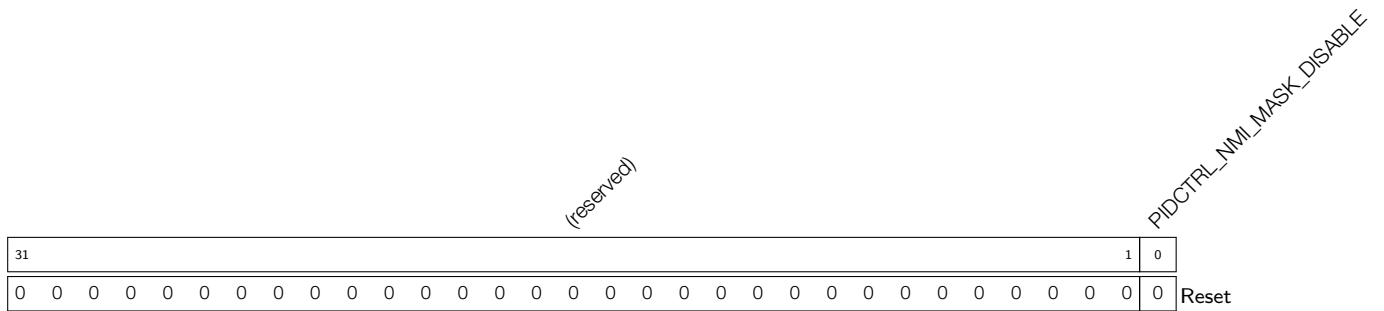
**PIDCTRL\_PID\_CONFIRM** This bit is used to confirm the switch of PID. (WO)

**Register 28.15. PIDCTRL\_NMI\_MASK\_ENABLE\_REG (0x054)**



**PIDCTRL\_NMI\_MASK\_ENABLE** This bit is used to enable CPU NMI interrupt mask signal. (WO)

**Register 28.16. PIDCTRL\_NMI\_MASK\_DISABLE\_REG (0x058)**



**PIDCTRL\_NMI\_MASK\_DISABLE** This bit is used to disable CPU NMI interrupt mask signal. (WO)

## 29 On-Chip Sensors and Analog Signal Processing

### 29.1 Introduction

ESP32 has two types of built-in sensors for various applications: a [capacitive touch sensor](#) with up to 10 inputs, and a [Hall effect sensor](#).

The processing of analog signals is done by two [successive approximation ADCs](#) (SAR ADC). There are five controllers dedicated to operating ADCs. This provides flexibility when it comes to converting analog inputs in both high-performance and low-power modes, with minimum processor overhead.

ESP32 is also capable of generating analog signals, using two [independent DACs](#) and a [cosine waveform generator](#).

### 29.2 Capacitive Touch Sensor

#### 29.2.1 Introduction

A touch-sensor system is built on a substrate which carries electrodes and relevant connections under a protective flat surface; see Figure 29-1. When a user touches the surface, the capacitance variation is triggered and a binary signal is generated to indicate whether the touch is valid.

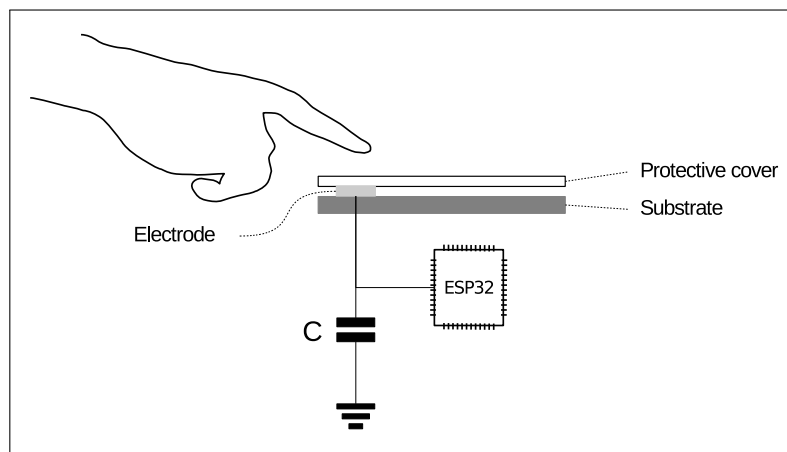


Figure 29-1. Touch Sensor

#### 29.2.2 Features

- Up to 10 capacitive touch pads / GPIOs
- The sensing pads can be arranged in different combinations, so that a larger area or more points can be detected.
- The touch pad sensing process is under the control of a hardware-implemented finite-state machine (FSM) which is initiated by software or a dedicated hardware timer.
- Information that a pad has been touched can be obtained:
  - by checking touch-sensor registers directly through software,
  - from an interrupt triggered by a touch detection,
  - by waking up the CPU from deep sleep upon touch detection.

- Support for low-power operation in the following scenarios:
  - CPU waiting in deep sleep and saving power until touch detection and subsequent wake up
  - Touch detection managed by the ULP coprocessor  
The user program in ULP coprocessor can trigger a scanning process by checking and writing into specific registers, in order to verify whether the touch threshold is reached.

### 29.2.3 Available GPIOs

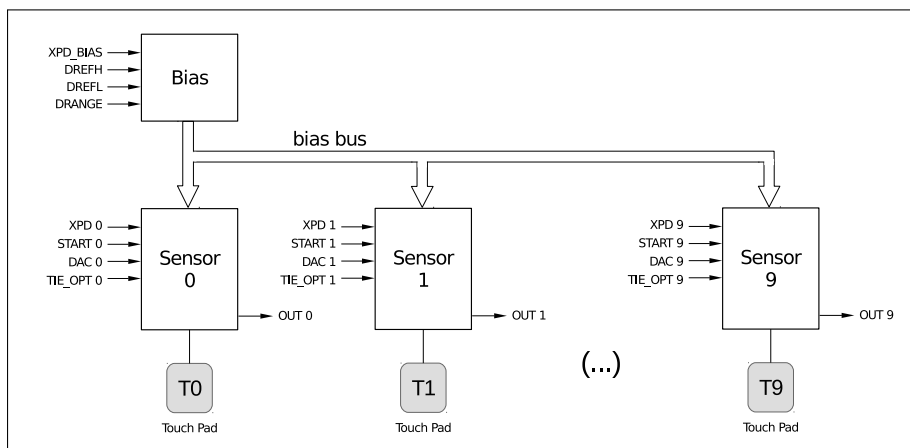
All 10 available sensing GPIOs (pads) are listed in Table 29-1.

**Table 29-1. ESP32 Capacitive Sensing Touch Pads**

Touch Sensing Signal Name	Pin Name
T0	GPIO4
T1	GPIO0
T2	GPIO2
T3	MTDO
T4	MTCK
T5	MTDI
T6	MTMS
T7	GPIO27
T8	32K_XN
T9	32K_XP

### 29.2.4 Functional Description

The internal structure of the touch sensor is shown in Figure 29-2. The operating flow is shown in Figure 29-3.



**Figure 29-2. Touch Sensor Structure**

The capacitance of a touch pad is periodically charged and discharged. The chart "Pad Voltage" shows the charge/discharge voltage that swings from DREFH (reference voltage high) to DREFL (reference voltage low). During each swing, the touch sensor generates an output pulse, shown in the chart as "OUT". The swing slope is different when the pad is touched (high capacitance) and when it is not (low capacitance). By comparing the difference between the output pulse counts during the same time interval, we can conclude whether the touch pad has been touched. TIE\_OPT is used to establish the initial voltage level that starts the charge/discharge cycle.

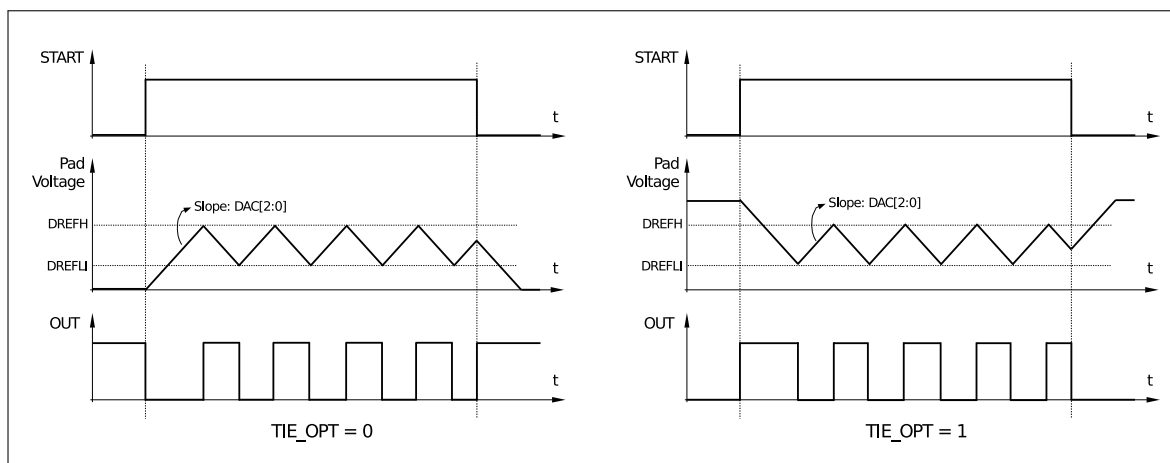


Figure 29-3. Touch Sensor Operating Flow

### 29.2.5 Touch FSM

The Touch FSM performs a measurement sequence described in section 29.2.4. Software can operate the Touch FSM through dedicated registers. The internal structure of a touch FSM is shown in Figure 29-4.

The functions of Touch FSM include:

- Receipt of a start signal, either from software or a timer
  - when `SENS_SAR_TOUCH_START_FORCE=1`, `SENS_SAR_TOUCH_START_EN` is used to initiate a single measurement
  - when `SENS_SAR_TOUCH_START_FORCE=0`, measurement is triggered periodically with a timer.

The Touch FSM can be active in sleep mode. The `SENS_SAR_TOUCH_SLEEP_CYCLES` register can be used to set the cycles. The sensor is operated by `RTC_FAST_CLK`, which normally runs at 8 MHz. More information on that can be found in chapter [Reset and Clock](#).

- Generation of `XPD_TOUCH_BIAS` / `TOUCH_XPD` / `TOUCH_START` with adjustable timing sequence  
To select enabled pads, `TOUCH_XPD` / `TOUCH_START` is masked by the 10-bit register `SENS_SAR_TOUCH_PAD_WORKEN`.
- Counting of pulses on `TOUCH0_OUT` ~ `TOUCH9_OUT`  
The result can be read from `SENS_SAR_TOUCH_MEAS_OUTn`. All ten touch sensors can work simultaneously.
- Generation of a wakeup interrupt  
The FSM regards the touch pads as “touched”, if the number of counted pulses is below the threshold. The 10-bit registers `SENS_TOUCH_PAD_OUTEN1` & `SENS_TOUCH_PAD_OUTEN2` define two sets of touch pads, i.e. SET1 & SET2. If at least one of the pads in SET1 is “touched”, the wakeup interrupt will be generated by default. It is also possible to configure the wakeup interrupt to be generated only when pads from both sets are “touched”.

## 29.3 SAR ADC

### 29.3.1 Introduction

ESP32 integrates two 12-bit SAR ADCs. They are managed by five SAR ADC controllers, and are able to measure signals from one to 18 analog pads. It is also possible to measure internal signals, such as `vdd33`.

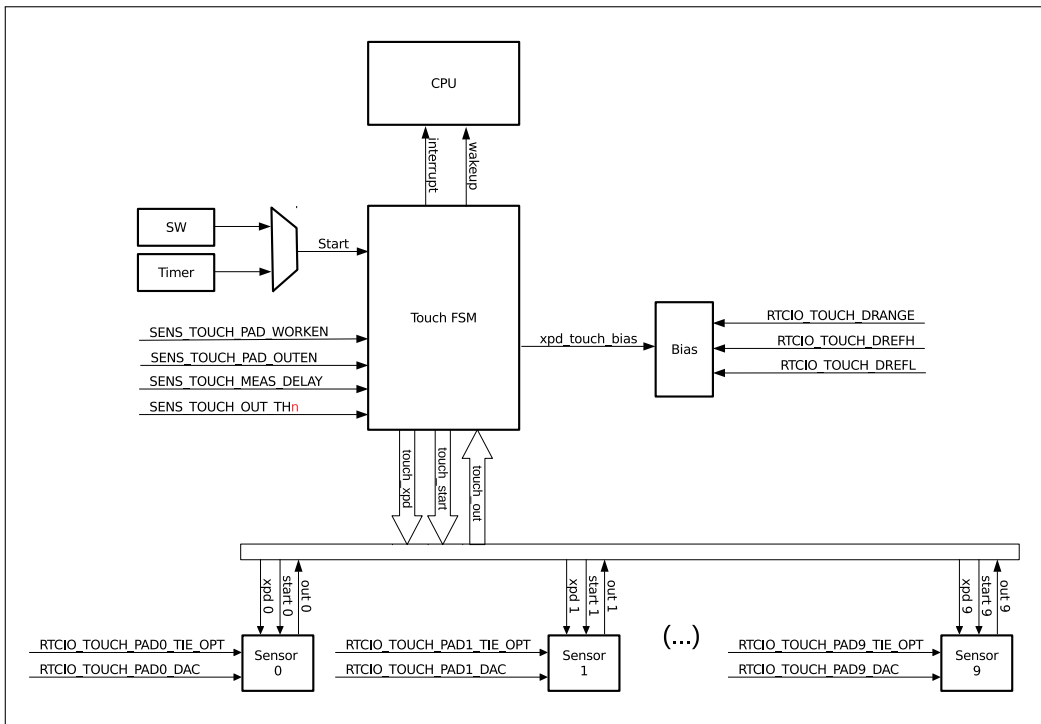


Figure 29-4. Touch FSM Structure

The SAR ADC controllers have specialized uses. Two of them support high-performance multiple-channel scanning. Another two are used for low-power operation during deep sleep, and the last one is dedicated to PWDET / PKDET (power and peak detection). A diagram of the SAR ADCs is shown in Figure 29-5.

**Note:**

PWDET/PKDET controller is for Wi-Fi internal use only. If Wi-Fi module is using the SAR ADC2, users can not measure the analog signal from the pins using SAR ADC2. After SAR ADC2 is released by Wi-Fi, users can use SAR ADC2 normally.

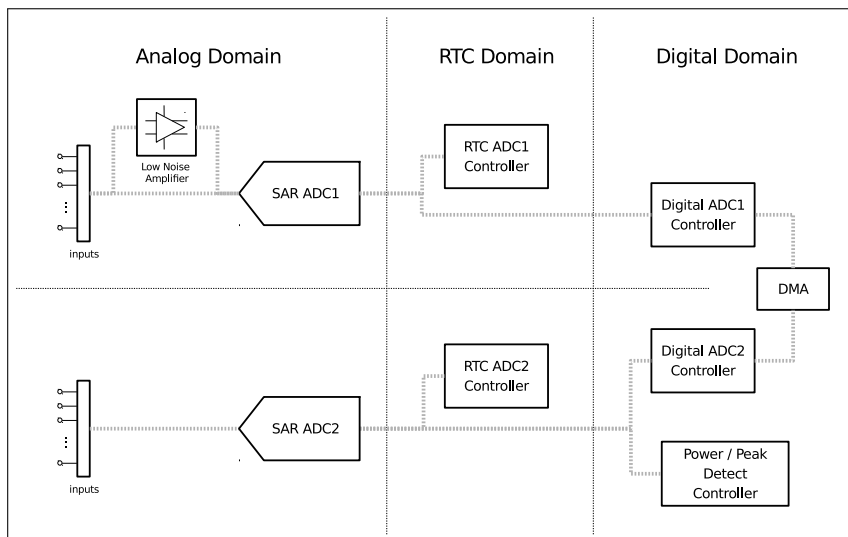


Figure 29-5. SAR ADC Depiction



### 29.3.2 Features

- Two SAR ADCs, with simultaneous sampling and conversion
- Up to five SAR ADC controllers for different purposes (e.g. high performance, low power or PWDET / PKDET).
- Up to 18 analog input pads
- One channel for internal voltage vdd33, two for pa\_pkdet (available on selected controllers)
- 12-bit, 11-bit, 10-bit, 9-bit configurable resolution
- DMA support (available on one controller)
- Multiple channel-scanning modes (available on two controllers)
- Operation during deep sleep (available on one controller)
- Controlled by a ULP coprocessor (available on two controllers)

### 29.3.3 Outline of Function

The SAR ADC module's major components, and their interconnections, are shown in Figure 29-6.

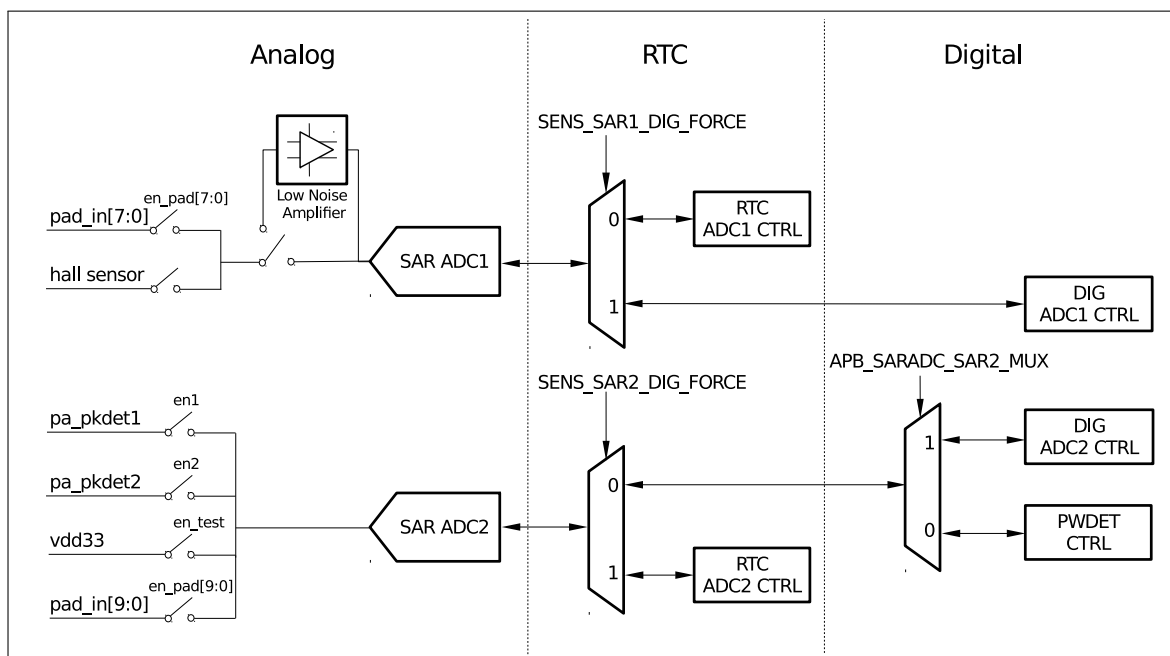


Figure 29-6. SAR ADC Outline of Function

A summary of all the analog signals that may be sent to the SAR ADC module for processing by either ADC1 or ADC2 is presented in Table 29-2.

Table 29-2. Inputs of SAR ADC module

Signal Name	Pad #	Processed by
VDET_2	7	SAR ADC1
VDET_1	6	
32K_XN	5	
32K_XP	4	
SENSOR_VN	3	

Signal Name	Pad #	Processed by
SENSOR_CAPN	2	
SENSOR_CAPP	1	
SENSOR_VP	0	
Hall sensor	n/a	
GPIO26	9	SAR ADC2
GPIO25	8	
GPIO27	7	
MTMS	6	
MTDI	5	
MTCK	4	
MTDO	3	
GPIO2	2	
GPIO0	1	
GPIO4	0	
pa_pkdet1	n/a	
pa_pkdet2	n/a	
vdd33	n/a	

**Note:**

Some of the SAR ADC2 pins are used as strapping pins (GPIO0, GPIO2, and GPIO15), thus can not be used freely.

There are five ADC controllers in ESP32: RTC ADC1 CTRL, RTC ADC2 CTRL, DIG ADC1 CTRL, DIG ADC2 CTRL and PWDET CTRL. The differences between them are summarized in Table 29-3.

**Table 29-3. ESP32 SAR ADC Controllers**

	RTC ADC1	RTC ADC2	DIG ADC1	DIG ADC2	PWDET
DAC	Y	-	-	-	-
Support deep sleep	Y	Y	-	-	-
ULP coprocessor	Y	Y	-	-	-
vdd33	-	Y	-	Y	-
PWDET/PKDET	-	-	-	-	Y
Hall sensor	Y	-	-	-	-
DMA	-	-	Y	-	-

### 29.3.4 RTC SAR ADC Controllers

The purpose of SAR ADC controllers in the RTC power domain – RTC ADC1 CTRL and RTC ADC2 CTRL – is to provide ADC measurement with minimal power consumption in a low frequency.

The outline of a single controller's function is shown in Figure 29-7. For each controller, the start of analog-to-digital conversion can be triggered by register `SENS_SAR_MEASn_START_SAR`. The measurement's result can be obtained from register `SENS_SAR_MEASn_DATA_SAR`.

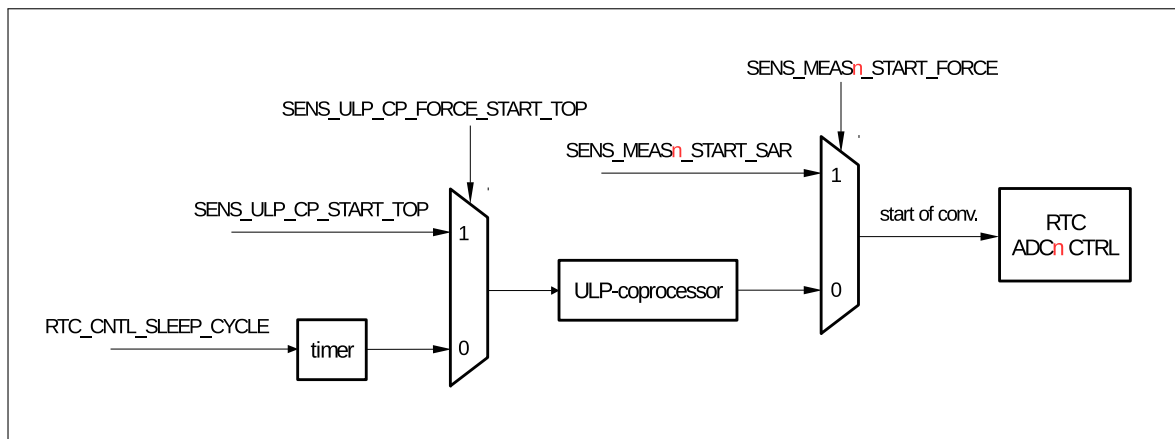


Figure 29-7. RTC SAR ADC Outline of Function

The controllers are intertwined with the ULP coprocessor, as the ULP coprocessor has a built-in instruction to start an ADC measurement. In many cases, the controllers need to cooperate with the ULP coprocessor, e.g.:

- when periodically monitoring a channel during deep sleep, where the ULP coprocessor is the only trigger source during this mode;
- when scanning channels continuously in a sequence. Continuous scanning or DMA is not supported by the controllers. However, it is possible with the help of the ULP coprocessor.

### 29.3.5 DIG SAR ADC Controllers

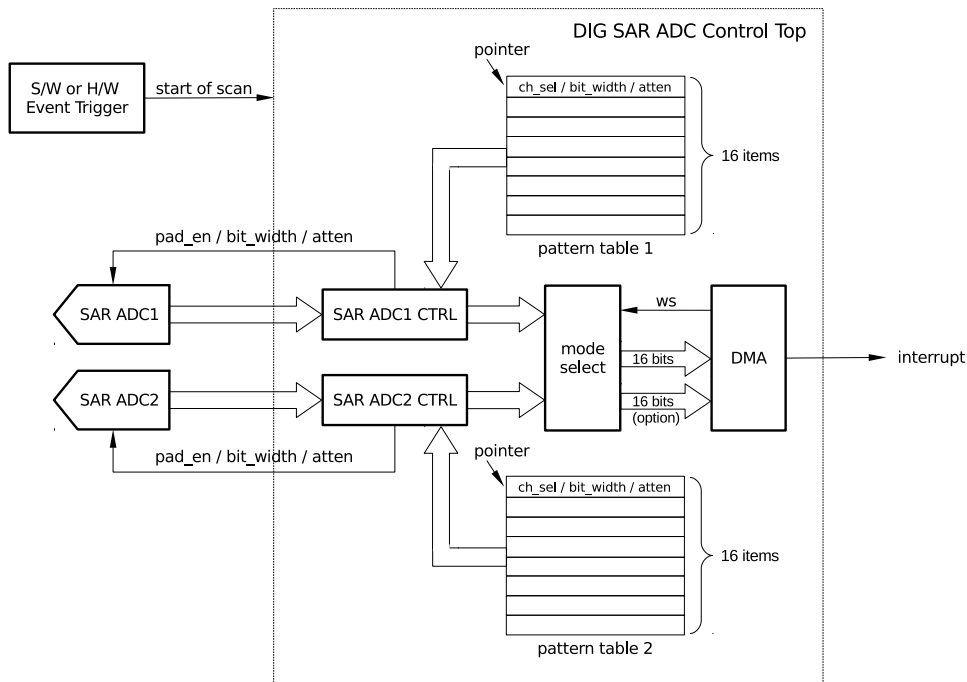
Compared to RTC SAR ADC controllers, DIG SAR ADC controllers have optimized performance and throughput. Some of their features are:

- High performance; the clock is much faster, therefore, the sample rate is highly increased.
- Multiple-channel scanning mode; there is a pattern table that defines the measurement rule for each SAR ADC. The scanning mode can be configured as a single mode, double mode, or alternate mode.
- The scanning can be started by software or I2S.
- DMA support; an interrupt will be generated when scanning is finished.

**Note:**

We do not use the term “start of conversion” in this section, because there is no direct access to starting a single SAR analog-to-digital conversion. We use “start of scan” instead, which implies that we expect to scan a sequence of channels with DIG ADC controllers.

Figure 29-8 shows a diagram of DIG SAR ADC controllers.



**Figure 29-8. Diagram of DIG SAR ADC Controllers**

The pattern tables contain the measurement rules mentioned above. Each table has 16 items which store information on channel selection, resolution and attenuation. When scanning starts, the controller reads measurement rules one-by-one from a pattern table. For each controller the scanning sequence includes 16 different rules at most, before repeating itself.

The 8-bit item (the pattern table register) is composed of three fields that contain channel, resolution and attenuation information, as shown in Table 29-4.

**Table 29-4. Fields of the Pattern Table Register**

Pattern Table Register [7:0]		
ch_sel[3:0]	bit_width[1:0]	atten[1:0]
channel to be scanned	resolution	attenuation

There are three scanning modes: single mode, double mode and alternate mode.

- Single mode: channels of either SAR ADC1 or SAR ADC2 will be scanned.
- Double mode: channels of SAR ADC1 and SAR ADC2 will be scanned simultaneously.
- Alternate mode: channels of SAR ADC1 and SAR ADC2 will be scanned alternately.

ESP32 supports up to a 12-bit SAR ADC resolution. The 16-bit data in DMA is composed of the ADC result and some necessary information related to the scanning mode:

- For single mode, only 4-bit information on channel selection is added.
- For double mode or alternate mode, 4-bit information on channel selection is added plus one extra bit indicating which SAR ADC was selected.

For each scanning mode there is a corresponding data format, called Type I and Type II. Both data formats are described in Tables 29-5 and 29-6.

**Table 29-5. Fields of Type I DMA Data Format**

Type I DMA Data Format [15:0]	
ch_sel[3:0]	data[11:0]
channel	SAR ADC data

**Table 29-6. Fields of Type II DMA Data Format**

Type II DMA Data Format [15:0]		
sar_sel	ch_sel[3:0]	SAR ADC data[10:0]
SAR ADCn	channel	SAR ADC data

For Type I the resolution of SAR ADC is up to 12 bits, while for Type II the resolution is 11 bits at most.

DIG SAR ADC Controllers allow the use of I2S for direct memory access. The WS signal of I2S acts as a measurement-trigger signal. The DATA signal provides the information that the measurement result is ready. Software can configure `APB_SARADC_DATA_TO_I2S`, in order to connect ADC to I2S.

## 29.4 Hall Sensor

### 29.4.1 Introduction

The Hall effect is the generation of a voltage difference across an n-type semiconductor passing electrical current, when a magnetic field is applied to it in a direction perpendicular to that of the flow of the current. The voltage is proportional to the product of the magnetic field's strength and current value. A Hall-effect sensor could be used to measure the strength of a magnetic field, when constant current flows through it, or when the current is in the presence of a constant magnetic field. As the heart of many applications, the Hall-effect sensors provide proximity detection, positioning, speed measurement, and current sensing.

Inside of ESP32 there is a Hall sensor for magnetic field-sensing applications, which is designed to feed voltage signals to the SAR ADC. It can be controlled by the ULP coprocessor, when low-power operation is required. Such functionality, which enhances the power-processing and flexibility of ESP32, makes it an attractive solution for position sensing, proximity detection, speed measurement, etc.

### 29.4.2 Features

- Built-in Hall element
- Designed to operate with ADC
- Capable of outputting both analog voltage and digital signals related to the strength of the magnetic field
- Powerful and easy-to-implement functionality, due to its integration with built-in ULP coprocessor, GPIOs, CPU, Wi-Fi, etc.

### 29.4.3 Functional Description

The Hall sensor converts the magnetic field into voltage, feeds it into an amplifier, and then outputs it through pin `SENSOR_VP` and pin `SENSOR_VN`. ESP32's built-in ADC converts the voltage into a digital value for processing by the CPU in the digital domain.

The inner structure of a Hall sensor is shown in Figure 29-9.

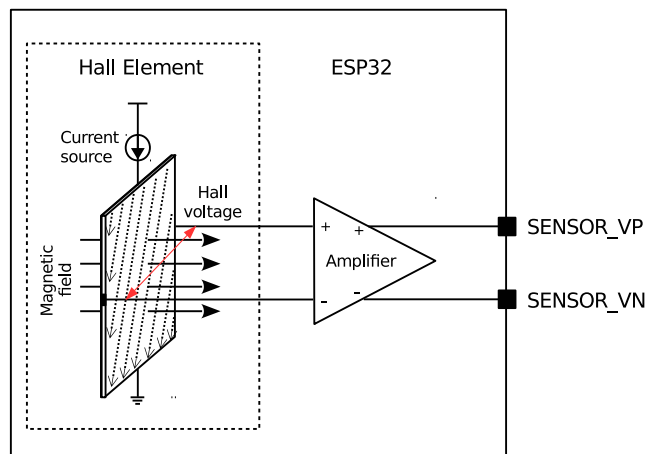


Figure 29-9. Hall Sensor

The configuration of a Hall sensor for reading is done with registers [SENS\\_SAR\\_TOUCH\\_CTRL1\\_REG](#) and [RTCIO\\_HALL\\_SENS\\_REG](#), which are used to power up the Hall sensor. The subsequent processing is done by SAR ADC1. The result is obtained from the RTC ADC1 controller. For more details, please refer to section [29.3](#).

## 29.5 DAC

### 29.5.1 Introduction

Two 8-bit DAC channels can be used to convert digital values into analog output signals (up to two of them). The design structure is composed of integrated resistor strings and a buffer. This dual DAC supports power supply and uses it as input voltage reference. The dual DAC also supports independent or simultaneous signal conversions inside of its channels.

### 29.5.2 Features

The features of DAC are as follows:

- Two 8-bit DAC channels
- Independent or simultaneous conversion in channels
- Voltage reference from the VDD3P3\_RTC pin
- Cosine waveform (CW) generator
- DMA capability
- Start of conversion can be triggered by software or SAR ADC FSM (please refer to the [SAR ADC chapter](#) for more details)
- Can be fully controlled by the ULP coprocessor

A diagram showing the DAC channel's function is presented in Figure 29-10. For a detailed description, see the sections below.

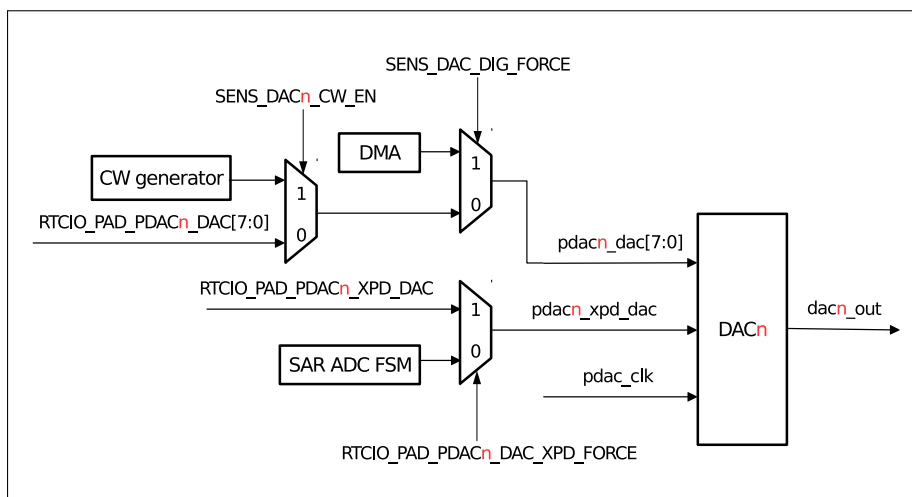


Figure 29-10. Diagram of DAC Function

### 29.5.3 Structure

The two 8-bit DAC channels can be configured independently. For each DAC channel, the output analog voltage can be calculated as follows:

$$\text{DAC}_n\text{\_OUT} = \text{VDD3P3\_RTC} \cdot \text{PDAC}_n\text{\_DAC} / 255$$

- VDD3P3\_RTC is the voltage on pin VDD3P3\_RTC (typically 3.3V).
- PDAC<sub>n</sub>\_DAC has multiple sources: CW generator, register RTCIO\_PAD\_DAC<sub>n</sub>\_REG, and DMA.

The start of conversion is determined by register RTCIO\_PAD\_PDAC<sub>n</sub>\_XPD\_DAC. The conversion process itself is controlled by software or SAR ADC FSM; see Figure 29-10.

### 29.5.4 Cosine Waveform Generator

The cosine waveform (CW) generator can be used to generate a cosine / sine tone. A diagram showing cosine waveform generator's function is presented in Figure 29-11.

The CW generator has the following features:

- Adjustable frequency  
The frequency of CW can be adjusted by register SENS\_SAR\_SW\_FSTEP[15:0]:

$$\text{freq} = \text{dig\_clk\_rtc\_freq} \cdot \text{SENS\_SAR\_SW\_FSTEP} / 65536$$

The frequency of dig\_clk\_rtc is typically 8 MHz.

- Scaling  
Configuring register SENS\_SAR\_DAC\_SCALE<sub>n</sub>[1:0]; the amplitude of a CW can be multiplied by 1, 1/2, 1/4 or 1/8.
- DC offset  
The offset may be introduced by register SENS\_SAR\_DAC\_DC<sub>n</sub>[7:0]. The result will be saturated.
- Phase shift  
A phase-shift of 0 / 90 / 180 / 270 degrees can be added by setting register SENS\_SAR\_DAC\_INV<sub>n</sub>[1:0].

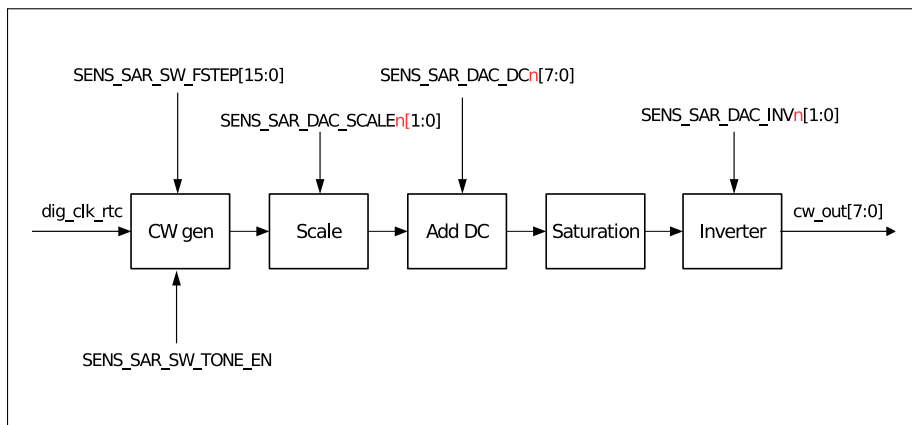


Figure 29-11. Cosine Waveform (CW) Generator

### 29.5.5 DMA support

A DMA controller with dual DMA channels can be used to set the output of two DAC channels. By configuring [SENS\\_SAR\\_DAC\\_DIG\\_FORCE](#), I2S\_clk can be connected to DAC clk, and I2S\_DATA\_OUT can be connected to DAC\_DATA for direct memory access.

For details, please refer to chapter [DMA](#).



## 29.6 Register Summary

Note: The registers listed below have been grouped, according to their functionality. This particular grouping does not reflect the exact sequential order of their place in memory.

### 29.6.1 Sensors

Name	Description	Address	Access
<b>Touch pad setup and control registers</b>			
<a href="#">SENS_SAR_TOUCH_CTRL1_REG</a>	Touch pad control	0x3FF48858	R/W
<a href="#">SENS_SAR_TOUCH_CTRL2_REG</a>	Touch pad control and status	0x3FF48884	RO
<a href="#">SENS_SAR_TOUCH_ENABLE_REG</a>	Wakeup interrupt control and working set	0x3FF4888C	R/W
<a href="#">SENS_SAR_TOUCH_THRES1_REG</a>	Threshold setup for pads 0 and 1	0x3FF4885C	R/W
<a href="#">SENS_SAR_TOUCH_THRES2_REG</a>	Threshold setup for pads 2 and 3	0x3FF48860	R/W
<a href="#">SENS_SAR_TOUCH_THRES3_REG</a>	Threshold setup for pads 4 and 5	0x3FF48864	R/W
<a href="#">SENS_SAR_TOUCH_THRES4_REG</a>	Threshold setup for pads 6 and 7	0x3FF48868	R/W
<a href="#">SENS_SAR_TOUCH_THRES5_REG</a>	Threshold setup for pads 8 and 9	0x3FF4886C	R/W
<a href="#">SENS_SAR_TOUCH_OUT1_REG</a>	Counters for pads 0 and 1	0x3FF48870	RO
<a href="#">SENS_SAR_TOUCH_OUT2_REG</a>	Counters for pads 2 and 3	0x3FF48874	RO
<a href="#">SENS_SAR_TOUCH_OUT3_REG</a>	Counters for pads 4 and 5	0x3FF48878	RO
<a href="#">SENS_SAR_TOUCH_OUT4_REG</a>	Counters for pads 6 and 6	0x3FF4887C	RO
<a href="#">SENS_SAR_TOUCH_OUT5_REG</a>	Counters for pads 8 and 9	0x3FF48880	RO
<b>SAR ADC control register</b>			
<a href="#">SENS_SAR_START_FORCE_REG</a>	SAR ADC1 and ADC2 control	0x3FF4882C	R/W
<b>SAR ADC1 control registers</b>			
<a href="#">SENS_SAR_READ_CTRL_REG</a>	SAR ADC1 data and sampling control	0x3FF48800	R/W
<a href="#">SENS_SAR_MEAS_START1_REG</a>	SAR ADC1 conversion control and status	0x3FF48854	RO
<b>SAR ADC2 control registers</b>			
<a href="#">SENS_SAR_READ_CTRL2_REG</a>	SAR ADC2 data and sampling control	0x3FF48890	R/W
<a href="#">SENS_SAR_MEAS_START2_REG</a>	SAR ADC2 conversion control and status	0x3FF48894	RO
<b>ULP coprocessor configuration register</b>			
<a href="#">SENS_ULP_CP_SLEEP_CYC0_REG</a>	Sleep cycles for ULP coprocessor	0x3FF48818	R/W
<b>Pad attenuation configuration registers</b>			
<a href="#">SENS_SAR_ATTEN1_REG</a>	2-bit attenuation for each pad	0x3FF48834	R/W
<a href="#">SENS_SAR_ATTEN2_REG</a>	2-bit attenuation for each pad	0x3FF48838	R/W
<b>DAC control registers</b>			
<a href="#">SENS_SAR_DAC_CTRL1_REG</a>	DAC control	0x3FF48898	R/W
<a href="#">SENS_SAR_DAC_CTRL2_REG</a>	DAC output control	0x3FF4889C	R/W

### 29.6.2 Advanced Peripheral Bus

Name	Description	Address	Access
<b>SAR ADC1 and ADC2 common configuration registers</b>			
<a href="#">APB_SARADC_CTRL_REG</a>	SAR ADC common configuration	0x60002610	R/W
<a href="#">APB_SARADC_CTRL2_REG</a>	SAR ADC common configuration	0x60002614	R/W
<a href="#">APB_SARADC_FSM_REG</a>	SAR ADC FSM sample cycles configuration	0x60002618	R/W
<b>SAR ADC1 pattern table registers</b>			

<a href="#">APB_SARADC_SAR1_PATT_TAB1_REG</a>	Items 0 - 3 of pattern table	0x6000261C	R/W
<a href="#">APB_SARADC_SAR1_PATT_TAB2_REG</a>	Items 4 - 7 of pattern table	0x60002620	R/W
<a href="#">APB_SARADC_SAR1_PATT_TAB3_REG</a>	Items 8 - 11 of pattern table	0x60002624	R/W
<a href="#">APB_SARADC_SAR1_PATT_TAB4_REG</a>	Items 12 - 15 of pattern table	0x60002628	R/W
<b>SAR ADC2 pattern table registers</b>			
<a href="#">APB_SARADC_SAR2_PATT_TAB1_REG</a>	Items 0 - 3 of pattern table	0x6000262C	R/W
<a href="#">APB_SARADC_SAR2_PATT_TAB2_REG</a>	Items 4 - 7 of pattern table	0x60002630	R/W
<a href="#">APB_SARADC_SAR2_PATT_TAB3_REG</a>	Items 8 - 11 of pattern table	0x60002634	R/W
<a href="#">APB_SARADC_SAR2_PATT_TAB4_REG</a>	Items 12 - 15 of pattern table	0x60002638	R/W

### 29.6.3 RTC I/O

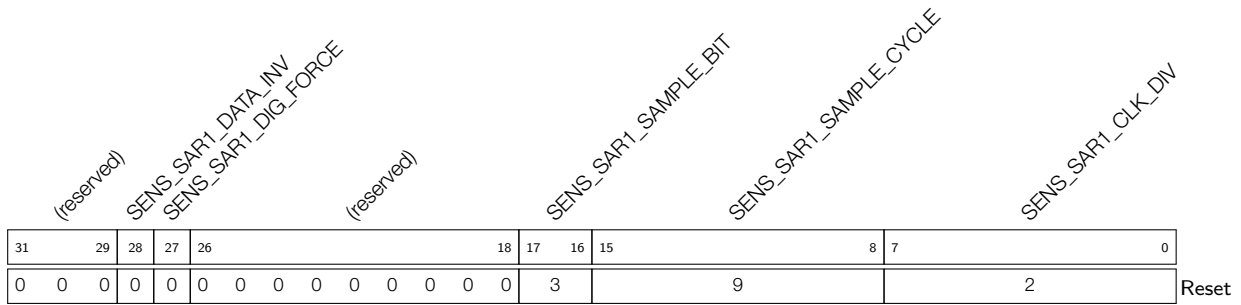
For details, please refer to Section [Register Summary](#) in Chapter [IO\\_MUX and GPIO Matrix](#).

## 29.7 Registers

### 29.7.1 Sensors

The addresses in parenthesis besides register names are the register addresses relative to (the RTC base address + 0x0800). The RTC base address is provided in Table 1-6 *Peripheral Address Mapping* in Chapter 1 *System and Memory*. The absolute register addresses are listed in Section 29.6.1 *Sensors*.

**Register 29.1. SENS\_SAR\_READ\_CTRL\_REG (0x0000)**



**SENS\_SAR1\_DATA\_INV** Invert SAR ADC1 data. (R/W)

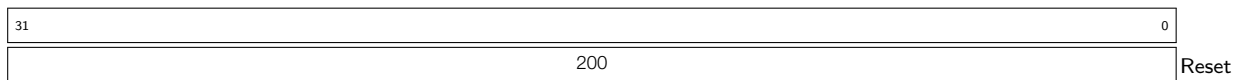
**SENS\_SAR1\_DIG\_FORCE** 1: SAR ADC1 controlled by DIG ADC1 CTRL, 0: SAR ADC1 controlled by RTC ADC1 CTRL. (R/W)

**SENS\_SAR1\_SAMPLE\_BIT** Bit width of SAR ADC1, 00: for 9-bit, 01: for 10-bit, 10: for 11-bit, 11: for 12-bit. (R/W)

**SENS\_SAR1\_SAMPLE\_CYCLE** Sample cycles for SAR ADC1. (R/W)

**SENS\_SAR1\_CLK\_DIV** Clock divider. (R/W)

**Register 29.2. SENS\_ULP\_CP\_SLEEP\_CYC0\_REG (0x0018)**



**SENS\_ULP\_CP\_SLEEP\_CYC0\_REG** Sleep cycles for ULP coprocessor timer. (R/W)

**Register 29.3. SENS\_SAR\_START\_FORCE\_REG (0x002c)**

31	(reserved)								24	23	22	21	(reserved)								11	10	9	8	7	(reserved)			5	4	3	2	1	0	Reset					
								SENS_SAR1_STOP SENS_SAR2_STOP												SENS_PC_INIT				SENS_ULP_CP_START_TOP SENS_ULP_CP_FORCE_START_TOP			SENS_SAR2_PWDET_CCT SENS_SAR2_EN_TEST			SENS_SAR2_BIT_WIDTH SENS_SAR1_BIT_WIDTH										
0 0 0 0 0 0 0 0								0 0 0 0 0 0 0 0				0 0 0 0 0 0 0 0								0 0 0 0				0 0 0			1 1 1			0 0								1		

- SENS\_SAR1\_STOP** Stop SAR ADC1 conversion. (R/W)
- SENS\_SAR2\_STOP** Stop SAR ADC2 conversion. (R/W)
- SENS\_PC\_INIT** Initialized PC for ULP coprocessor. (R/W)
- SENS\_ULP\_CP\_START\_TOP** Write 1 to start ULP coprocessor; it is active only when reg\_ulp\_cp\_force\_start\_top = 1. (R/W)
- SENS\_ULP\_CP\_FORCE\_START\_TOP** 1: ULP coprocessor is started by SW, 0: ULP coprocessor is started by timer. (R/W)
- SENS\_SAR2\_PWDET\_CCT** SAR2\_PWDET\_CCT, PA power detector capacitance tuning. (R/W)
- SENS\_SAR2\_EN\_TEST** SAR2\_EN\_TEST is active only when reg\_sar2\_dig\_force = 0. (R/W)
- SENS\_SAR2\_BIT\_WIDTH** Bit width of SAR ADC2, 00: 9 bits, 01: 10 bits, 10: 11 bits, 11: 12 bits. (R/W)
- SENS\_SAR1\_BIT\_WIDTH** Bit width of SAR ADC1, 00: 9 bits, 01: 10 bits, 10: 11 bits, 11: 12 bits. (R/W)

**Register 29.4. SENS\_SAR\_ATTEN1\_REG (0x0034)**

31																															0	Reset
0x0FFFFFFF																																

**SENS\_SAR\_ATTEN1\_REG** 2-bit attenuation for each pad, 11: 1 dB, 10: 6 dB, 01: 3 dB, 00: 0 dB, [1:0] is used for ADC1\_CH0, [3:2] is used for ADC1\_CH1, etc. (R/W)

**Register 29.5. SENS\_SAR\_ATTEN2\_REG (0x0038)**

31																															0	Reset
0x0FFFFFFF																																

**SENS\_SAR\_ATTEN2\_REG** 2-bit attenuation for each pad, 11: 1 dB, 10: 6 dB, 01: 3 dB, 00: 0 dB, [1:0] is used for ADC2\_CH0, [3:2] is used for ADC2\_CH1, etc (R/W)



**Register 29.7. SENS\_SAR\_TOUCH\_CTRL1\_REG (0x0058)**

(reserved)				SENS_HALL_PHASE_FORCE				SENS_XPD_HALL_FORCE				SENS_TOUCH_OUT_1EN				SENS_TOUCH_OUT_SEL				SENS_TOUCH_XPD_WAIT				SENS_TOUCH_MEAS_DELAY			
31	28	27	26	25	24	23	16	15	0																		
0	0	0	0	0	0	1	0	0x004	0x01000																		

Reset

**SENS\_HALL\_PHASE\_FORCE** 1: HALL PHASE is controlled by SW, 0: HALL PHASE is controlled by FSM in ULP coprocessor. (R/W)

**SENS\_XPD\_HALL\_FORCE** 1: XPD HALL is controlled by SW, 0: XPD HALL is controlled by FSM in ULP coprocessor. (R/W)

**SENS\_TOUCH\_OUT\_1EN** 1: wakeup interrupt is generated if SET1 is touched, 0: wakeup interrupt is generated only if both SET1 & SET2 are touched. (R/W)

**SENS\_TOUCH\_OUT\_SEL** 1: the touch pad is considered touched when the value of the counter is greater than the threshold, 0: the touch pad is considered touched when the value of the counter is less than the threshold. (R/W)

**SENS\_TOUCH\_XPD\_WAIT** The waiting time (in 8 MHz cycles) between TOUCH\_START and TOUCH\_XPD. (R/W)

**SENS\_TOUCH\_MEAS\_DELAY** The measurement's duration (in 8 MHz cycles). (R/W)

**Register 29.8. SENS\_SAR\_TOUCH\_THRES1\_REG (0x005c)**

SENS_TOUCH_OUT_TH0								SENS_TOUCH_OUT_TH1							
31	16	15	0												
0x00000	0x00000														

Reset

**SENS\_TOUCH\_OUT\_TH0** The threshold for touch pad 0. (R/W)

**SENS\_TOUCH\_OUT\_TH1** The threshold for touch pad 1. (R/W)

**Register 29.9. SENS\_SAR\_TOUCH\_THRES2\_REG (0x0060)**

<i>SENS_TOUCH_OUT_TH2</i>																<i>SENS_TOUCH_OUT_TH3</i>																	
31																16	15																0
0x00000																0x00000																Reset	

**SENS\_TOUCH\_OUT\_TH2** The threshold for touch pad 2. (R/W)

**SENS\_TOUCH\_OUT\_TH3** The threshold for touch pad 3. (R/W)

**Register 29.10. SENS\_SAR\_TOUCH\_THRES3\_REG (0x0064)**

<i>SENS_TOUCH_OUT_TH4</i>																<i>SENS_TOUCH_OUT_TH5</i>																	
31																16	15																0
0x00000																0x00000																Reset	

**SENS\_TOUCH\_OUT\_TH4** The threshold for touch pad 4. (R/W)

**SENS\_TOUCH\_OUT\_TH5** The threshold for touch pad 5. (R/W)

**Register 29.11. SENS\_SAR\_TOUCH\_THRES4\_REG (0x0068)**

<i>SENS_TOUCH_OUT_TH6</i>																<i>SENS_TOUCH_OUT_TH7</i>																	
31																16	15																0
0x00000																0x00000																Reset	

**SENS\_TOUCH\_OUT\_TH6** The threshold for touch pad 6. (R/W)

**SENS\_TOUCH\_OUT\_TH7** The threshold for touch pad 7. (R/W)

**Register 29.12. SENS\_SAR\_TOUCH\_THRES5\_REG (0x006c)**

<i>SENS_TOUCH_OUT_TH8</i>		<i>SENS_TOUCH_OUT_TH9</i>	
31	16	15	0
0x00000		0x00000	
			Reset

**SENS\_TOUCH\_OUT\_TH8** The threshold for touch pad 8. (R/W)

**SENS\_TOUCH\_OUT\_TH9** The threshold for touch pad 9. (R/W)

**Register 29.13. SENS\_SAR\_TOUCH\_OUT1\_REG (0x0070)**

<i>SENS_TOUCH_MEAS_OUT0</i>		<i>SENS_TOUCH_MEAS_OUT1</i>	
31	16	15	0
0x00000		0x00000	
			Reset

**SENS\_TOUCH\_MEAS\_OUT0** The counter for touch pad 0. (RO)

**SENS\_TOUCH\_MEAS\_OUT1** The counter for touch pad 1. (RO)

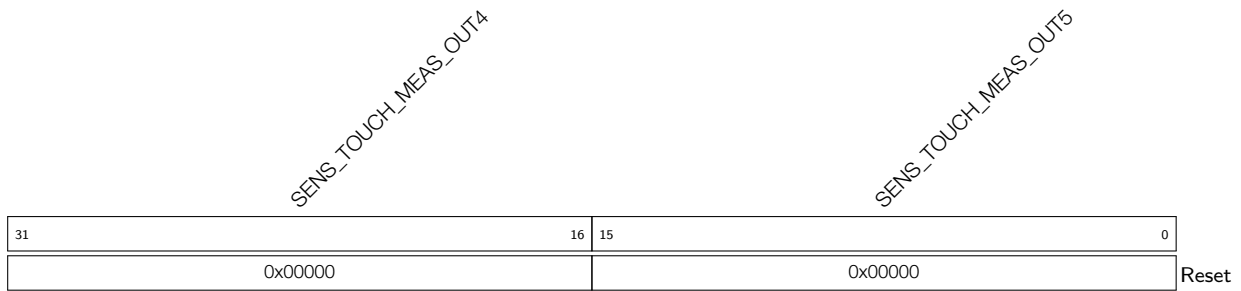
**Register 29.14. SENS\_SAR\_TOUCH\_OUT2\_REG (0x0074)**

<i>SENS_TOUCH_MEAS_OUT2</i>		<i>SENS_TOUCH_MEAS_OUT3</i>	
31	16	15	0
0x00000		0x00000	
			Reset

**SENS\_TOUCH\_MEAS\_OUT2** The counter for touch pad 2. (RO)

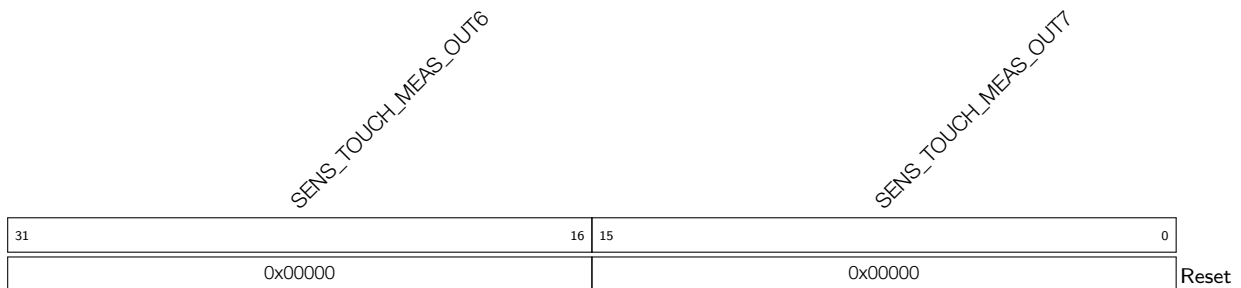
**SENS\_TOUCH\_MEAS\_OUT3** The counter for touch pad 3. (RO)



**Register 29.15. SENS\_SAR\_TOUCH\_OUT3\_REG (0x0078)**

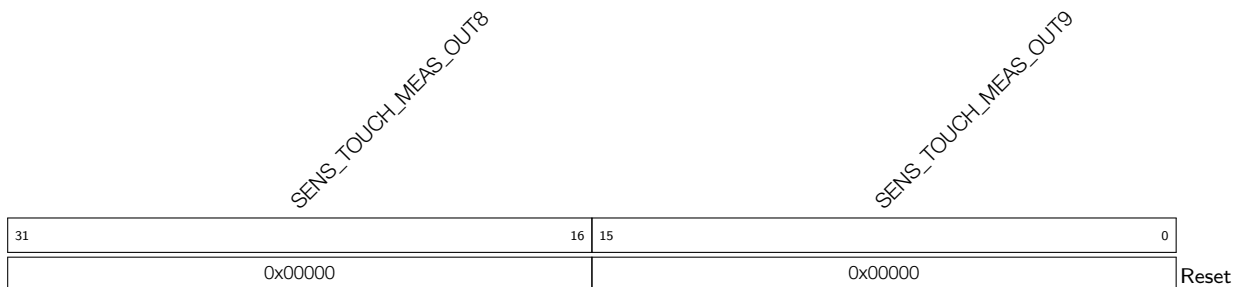
**SENS\_TOUCH\_MEAS\_OUT4** The counter for touch pad 4. (RO)

**SENS\_TOUCH\_MEAS\_OUT5** The counter for touch pad 5. (RO)

**Register 29.16. SENS\_SAR\_TOUCH\_OUT4\_REG (0x007c)**

**SENS\_TOUCH\_MEAS\_OUT6** The counter for touch pad 6. (RO)

**SENS\_TOUCH\_MEAS\_OUT7** The counter for touch pad 7. (RO)

**Register 29.17. SENS\_SAR\_TOUCH\_OUT5\_REG (0x0080)**

**SENS\_TOUCH\_MEAS\_OUT8** The counter for touch pad 8. (RO)

**SENS\_TOUCH\_MEAS\_OUT9** The counter for touch pad 9. (RO)

**Register 29.18. SENS\_SAR\_TOUCH\_CTRL2\_REG (0x0084)**

(reserved)			SENS_TOUCH_MEAS_EN_CLR												SENS_TOUCH_SLEEP_CYCLES				SENS_TOUCH_START_FORCE				SENS_TOUCH_START_EN				SENS_TOUCH_START_FSM_EN				SENS_TOUCH_MEAS_DONE				SENS_TOUCH_MEAS_EN									
31	30	29													14	13	12	11	10	9											0													
0	0		0x00100												0	0	1	0	0x000										Reset															

**SENS\_TOUCH\_MEAS\_EN\_CLR** Set to clear reg\_touch\_meas\_en. (WO)

**SENS\_TOUCH\_SLEEP\_CYCLES** Sleep cycles for timer. (R/W)

**SENS\_TOUCH\_START\_FORCE** 1: starts the Touch FSM via software; 0: starts the Touch FSM via timer. (R/W)

**SENS\_TOUCH\_START\_EN** 1: starts the Touch FSM; this is valid when reg\_touch\_start\_force is set. (R/W)

**SENS\_TOUCH\_START\_FSM\_EN** 1: TOUCH\_START & TOUCH\_XPD are controlled by the Touch FSM; 0: TOUCH\_START & TOUCH\_XPD are controlled by registers. (R/W)

**SENS\_TOUCH\_MEAS\_DONE** Set to 1 by FSM, indicating that touch measurement is done. (RO)

**SENS\_TOUCH\_MEAS\_EN** 10-bit register indicating which pads are touched. (RO)

**Register 29.19. SENS\_SAR\_TOUCH\_ENABLE\_REG (0x008c)**

(reserved)			SENS_TOUCH_PAD_OUTEN1																	SENS_TOUCH_PAD_OUTEN2																	SENS_TOUCH_PAD_WORKEN																					
31	30	29																		20	19																		10	9																		0
0	0		0x3FF																	0x3FF																	0x3FF																	Reset				

**SENS\_TOUCH\_PAD\_OUTEN1** Bitmap defining SET1 for generating a wakeup interrupt; SET1 is considered touched if at least one of the touch pads in SET1 is touched. (R/W)

**SENS\_TOUCH\_PAD\_OUTEN2** Bitmap defining SET2 for generating a wakeup interrupt; SET2 is considered touched if at least one of the touch pads in SET2 is touched. (R/W)

**SENS\_TOUCH\_PAD\_WORKEN** Bitmap defining the working set during measurement. (R/W)





## 29.7.2 Advanced Peripheral Bus

The addresses in parenthesis besides register names are the register addresses relative to the base address of 0x6000\_2600 (by AHB bus). The absolute register addresses are listed in Section [29.6.2 Advanced Peripheral Bus](#).

**Register 29.24. APB\_SARADC\_CTRL\_REG (0x10)**

(reserved)				APB_SARADC_DATA_TO_I2S				APB_SARADC_DATA_SAR_SEL				APB_SARADC_SAR2_PATT_P_CLEAR				APB_SARADC_SAR1_PATT_P_CLEAR				APB_SARADC_SAR2_PATT_LEN				APB_SARADC_SAR1_PATT_LEN				APB_SARADC_SAR_CLK_DIV				APB_SARADC_SAR_CLK_GATED				APB_SARADC_SAR_SEL				APB_SARADC_WORK_MODE				APB_SARADC_SAR2_MUX				APB_SARADC_START				APB_SARADC_START_FORCE			
31	27	26	25	24	23	22	19	18	15	14	7	6	5	4	3	2	1	0	Reset																																				
0	0	0	0	0	0	0	0	0	0	15	15	4	1	0	0	0	0	0	0																																				

**APB\_SARADC\_DATA\_TO\_I2S** 1: I2S input data is from SAR ADC (for DMA), 0: I2S input data is from GPIO matrix. (R/W)

**APB\_SARADC\_DATA\_SAR\_SEL** 1: sar\_sel will be coded by the MSB of the 16-bit output data, in this case, the resolution should not contain more than 11 bits; 0: using 12-bit SAR ADC resolution. (R/W)

**APB\_SARADC\_SAR2\_PATT\_P\_CLEAR** Clears the pointer of pattern table for DIG ADC2 CTRL. (R/W)

**APB\_SARADC\_SAR1\_PATT\_P\_CLEAR** Clears the pointer of pattern table for DIG ADC1 CTRL. (R/W)

**APB\_SARADC\_SAR2\_PATT\_LEN** SAR ADC2, 0 - 15 means pattern table length of 1 - 16. (R/W)

**APB\_SARADC\_SAR1\_PATT\_LEN** SAR ADC1, 0 - 15 means pattern table length of 1 - 16. (R/W)

**APB\_SARADC\_SAR\_CLK\_DIV** SAR clock divider. (R/W)

**APB\_SARADC\_SAR\_CLK\_GATED** Reserved. Please initialize to 0b1 (R/W)

**APB\_SARADC\_SAR\_SEL** 0: SAR1, 1: SAR2, this setting is applicable in the single SAR mode. (R/W)

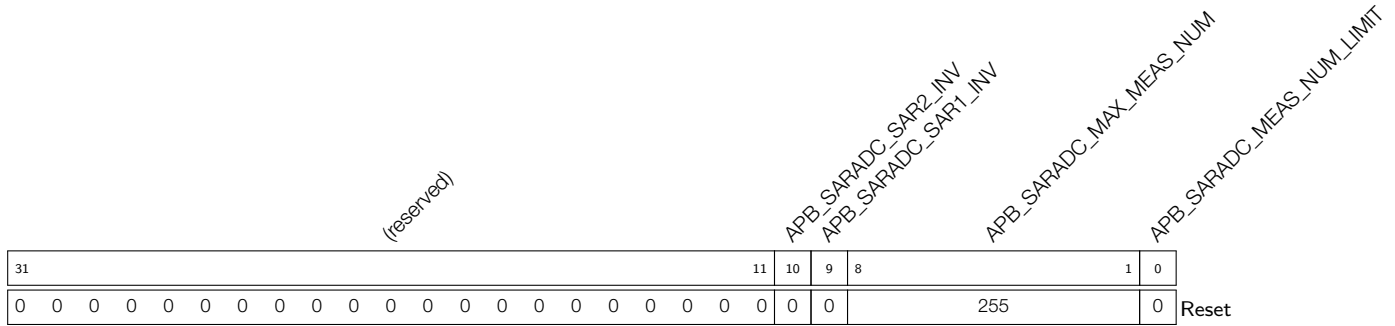
**APB\_SARADC\_WORK\_MODE** 0: single mode, 1: double mode, 2: alternate mode. (R/W)

**APB\_SARADC\_SAR2\_MUX** 1: SAR ADC2 is controlled by DIG ADC2 CTRL, 0: SAR ADC2 is controlled by PWDET CTRL. (R/W)

**APB\_SARADC\_START** Reserved. Please initialize to 0 (R/W)

**APB\_SARADC\_START\_FORCE** Reserved. Please initialize to 0 (R/W)

**Register 29.25. APB\_SARADC\_CTRL2\_REG (0x14)**



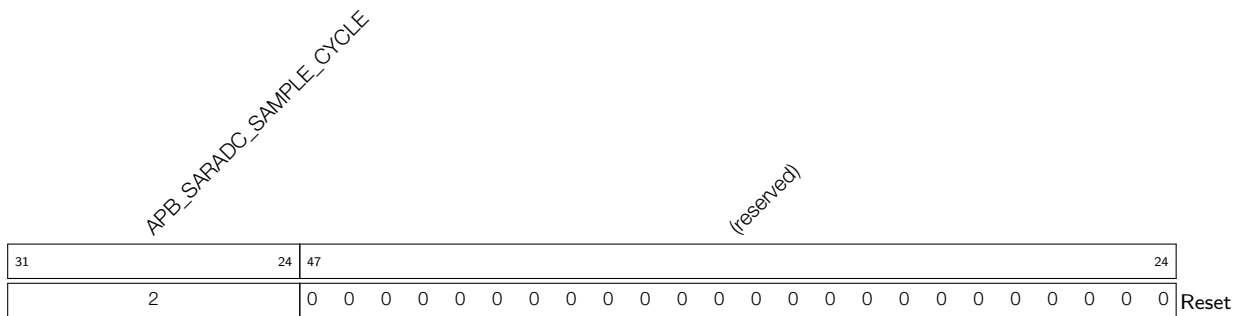
**APB\_SARADC\_SAR2\_INV** 1: data to DIG ADC2 CTRL is inverted, 0: data is not inverted. (R/W)

**APB\_SARADC\_SAR1\_INV** 1: data to DIG ADC1 CTRL is inverted, 0: data is not inverted. (R/W)

**APB\_SARADC\_MAX\_MEAS\_NUM** Max conversion number. (R/W)

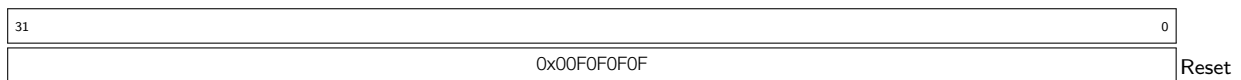
**APB\_SARADC\_MEAS\_NUM\_LIMIT** Reserved. Please initialize to 0b1 (R/W)

**Register 29.26. APB\_SARADC\_FSM\_REG (0x18)**



**APB\_SARADC\_SAMPLE\_CYCLE** Sample cycles. (R/W)

**Register 29.27. APB\_SARADC\_SAR1\_PATT\_TAB1\_REG (0x1C)**



**APB\_SARADC\_SAR1\_PATT\_TAB1\_REG** Pattern tables 0 - 3 for SAR ADC1, one byte for each pattern table: [31:28] pattern0\_channel, [27:26] pattern0\_bit\_width, [25:24] pattern0\_attenuation, [23:20] pattern1\_channel, etc. (R/W)

**Register 29.28. APB\_SARADC\_SAR1\_PATT\_TAB2\_REG (0x20)**

31	0
0x00F0F0F0F	

Reset

**APB\_SARADC\_SAR1\_PATT\_TAB2\_REG** Pattern tables 4 - 7 for SAR ADC1, one byte for each pattern table: [31:28] pattern4\_channel, [27:26] pattern4\_bit\_width, [25:24] pattern4\_attenuation, [23:20] pattern5\_channel, etc. (R/W)

**Register 29.29. APB\_SARADC\_SAR1\_PATT\_TAB3\_REG (0x24)**

31	0
0x00F0F0F0F	

Reset

**APB\_SARADC\_SAR1\_PATT\_TAB3\_REG** Pattern tables 8 - 11 for SAR ADC1, one byte for each pattern table: [31:28] pattern8\_channel, [27:26] pattern8\_bit\_width, [25:24] pattern8\_attenuation, [23:20] pattern9\_channel, etc. (R/W)

**Register 29.30. APB\_SARADC\_SAR1\_PATT\_TAB4\_REG (0x28)**

31	0
0x00F0F0F0F	

Reset

**APB\_SARADC\_SAR1\_PATT\_TAB4\_REG** Pattern tables 12 - 15 for SAR ADC1, one byte for each pattern table: [31:28] pattern12\_channel, [27:26] pattern12\_bit\_width, [25:24] pattern12\_attenuation, [23:20] pattern13\_channel, etc. (R/W)

**Register 29.31. APB\_SARADC\_SAR2\_PATT\_TAB1\_REG (0x2C)**

31	0
0x00F0F0F0F	

Reset

**APB\_SARADC\_SAR2\_PATT\_TAB1\_REG** Pattern tables 0 - 3 for SAR ADC2, one byte for each pattern table: [31:28] pattern0\_channel, [27:26] pattern0\_bit\_width, [25:24] pattern0\_attenuation, [23:20] pattern1\_channel, etc. (R/W)

**Register 29.32. APB\_SARADC\_SAR2\_PATT\_TAB2\_REG (0x30)**

31	0
0x00F0F0F0F	

Reset

**APB\_SARADC\_SAR2\_PATT\_TAB2\_REG** Pattern tables 4 - 7 for SAR ADC2, one byte for each pattern table: [31:28] pattern4\_channel, [27:26] pattern4\_bit\_width, [25:24] pattern4\_attenuation, [23:20] pattern5\_channel, etc. (R/W)

**Register 29.33. APB\_SARADC\_SAR2\_PATT\_TAB3\_REG (0x34)**

31	0
0x00F0F0F0F	

Reset

**APB\_SARADC\_SAR2\_PATT\_TAB3\_REG** Pattern tables 8 - 11 for SAR ADC2, one byte for each pattern table: [31:28] pattern8\_channel, [27:26] pattern8\_bit\_width, [25:24] pattern8\_attenuation, [23:20] pattern9\_channel, etc. (R/W)

**Register 29.34. APB\_SARADC\_SAR2\_PATT\_TAB4\_REG (0x38)**

31	0
0x00F0F0F0F	

Reset

**APB\_SARADC\_SAR2\_PATT\_TAB4\_REG** Pattern tables 12 - 15 for SAR ADC2, one byte for each pattern table: [31:28] pattern12\_channel, [27:26] pattern12\_bit\_width, [25:24] pattern12\_attenuation, [23:20] pattern13\_channel, etc. (R/W)

**29.7.3 RTC I/O**

For details, please refer to Section [Registers](#) in Chapter [IO\\_MUX](#) and [GPIO Matrix](#).



## 30 ULP Coprocessor (ULP)

### 30.1 Introduction

The ULP coprocessor is an ultra-low-power processor that remains powered on during the Deep-sleep mode of the main SoC. Hence, the developer can store in the RTC memory a program for the ULP coprocessor to access peripheral devices, internal sensors and RTC registers during deep sleep. This is useful for designing applications where the CPU needs to be woken up by an external event, or timer, or a combination of these, while maintaining minimal power consumption.

### 30.2 Features

- Contains up to 8 KB of SRAM for instructions and data
- Uses RTC\_FAST\_CLK, which is 8 MHz
- Works both in normal and deep sleep
- Is able to wake up the digital core or send an interrupt to the CPU
- Can access peripheral devices, internal sensors and RTC registers
- Contains four 16-bit general-purpose registers (R0, R1, R2, R3) for manipulating data and accessing memory
- Includes one 8-bit Stage\_cnt register which can be manipulated by ALU and used in JUMP instructions

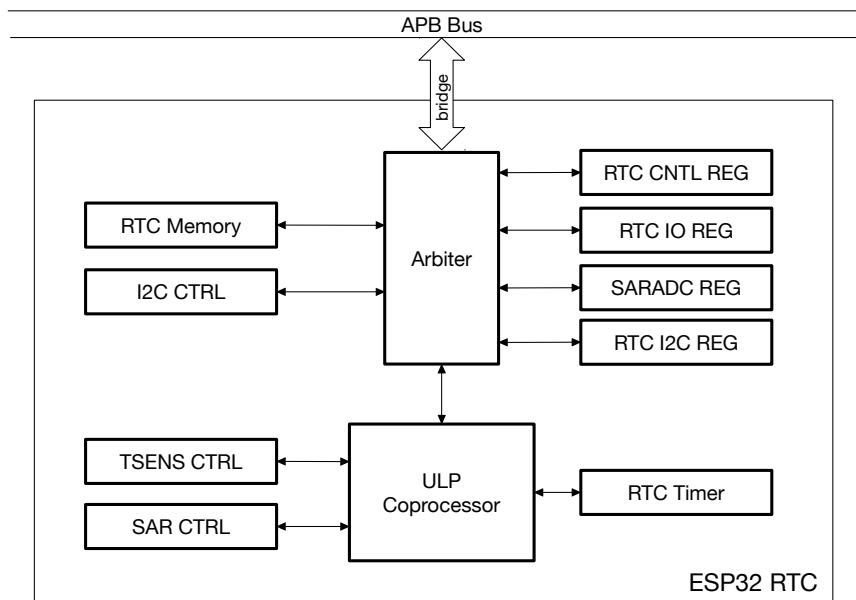


Figure 30-1. ULP Coprocessor Diagram

### 30.3 Functional Description

The ULP coprocessor is a programmable FSM (Finite State Machine) that can work during deep sleep. Like general-purpose CPUs, ULP coprocessor also has some instructions which can be useful for a relatively complex logic, and also some special commands for RTC controllers/peripherals. The 8 KB of SRAM RTC slow memory can be accessed by both the ULP coprocessor and the CPU; hence, it is usually used to store instructions and share data between the ULP coprocessor and the CPU.

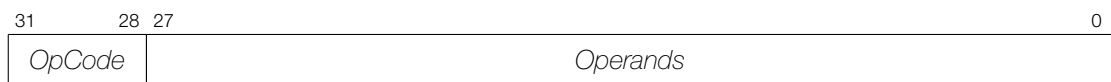
The ULP coprocessor can be started by software or a periodically-triggered timer. The operation of the ULP coprocessor is ended by executing the `HALT` instruction. Meanwhile, it can access almost every module in RTC domain, either through built-in instructions or RTC registers. In many cases the ULP coprocessor can be a good supplement to, or replacement of, the CPU, especially for power-sensitive applications. Figure 30-1 shows the overall layout of a ULP coprocessor.

### 30.4 Instruction Set

The ULP coprocessor provides the following instructions:

- Perform arithmetic and logic operations - ALU
- Load and store data - LD, ST, REG\_RD and REG\_WR
- Jump to a certain address - JUMP
- Manage program execution - WAIT/HALT
- Control sleep period of ULP coprocessor - SLEEP
- Wake up/communicate with SoC - WAKE
- Take measurements - ADC
- Communicate using I<sup>2</sup>C - I2C\_RD/I2C\_WR

The ULP coprocessor's instruction format is shown in Figure 30-2.



**Figure 30-2. The ULP Coprocessor Instruction Format**

An instruction, which has one *OpCode*, can perform various different operations, depending on the setting of *Operands* bits. A good example is the `ALU` instruction, which is able to perform 10 arithmetic and logic operations; or the `JUMP` instruction, which may be conditional or unconditional, absolute or relative.

Each instruction has a fixed width of 32 bits. A series of instructions can make a program be executed by the ULP coprocessor. The execution flow inside the program uses 32-bit addressing. The program is stored in a dedicated region called Slow Memory (`RTC_SLOW_MEM`), which is visible to the main CPUs as one that has an address range of `0x5000_0000` to `0x5000_1FFF` (8 KB).

The *OpCode* in this chapter is represented by 4'dx, where 4 stands for 4-bit width, 'd is a decimal symbol, x stands for the value of *OpCode* (x: 0 ~ 15).

#### 30.4.1 ALU - Perform Arithmetic/Logic Operations

The ALU (Arithmetic and Logic Unit) performs arithmetic and logic operations on values stored in ULP coprocessor registers, and on immediate values stored in the instruction itself.

The following operations are supported:

- Arithmetic: ADD and SUB
- Logic: bitwise logical AND and bitwise logical OR
- Bit shifting: LSH and RSH
- Moving data to register: MOVE
- Stage count register manipulation: STAGE\_RST, STAGE\_INC and STAGE\_DEC

The ALU instruction, which has one *OpCode*, can perform various different arithmetic and logic operations, depending on the setting of the instruction's bits [27:21] accordingly.

### 30.4.1.1 Operations Among Registers



Figure 30-3. Instruction Type — ALU for Operations Among Registers

When bits [27:25] of the instruction in Figure 30-3 are set to 3'b0, ALU performs operations, using the ULP coprocessor register R[0-3]. The types of operations depend on the setting of the instruction's bits [24:21] presented in Table 30-1.

**Operand**    **Description** - see Figure 30-3

*ALU\_sel*    Type of ALU operation

*Rdst*        Register R[0-3], destination

*Rsrc1*      Register R[0-3], source

*Rsrc2*      Register R[0-3], source

ALU_sel	Instruction	Operation	Description
0	ADD	$Rdst = Rsrc1 + Rsrc2$	Add to register
1	SUB	$Rdst = Rsrc1 - Rsrc2$	Subtract from register
2	AND	$Rdst = Rsrc1 \& Rsrc2$	Bitwise logical AND of two operands
3	OR	$Rdst = Rsrc1 \mid Rsrc2$	Bitwise logical OR of two operands
4	MOVE	$Rdst = Rsrc1$	Move to register
5	LSH	$Rdst = Rsrc1 \ll Rsrc2$	Bit shifting Left
6	RSH	$Rdst = Rsrc1 \gg Rsrc2$	Bit shifting Right

Table 30-1. ALU Operations Among Registers

**Note:**

- ADD/SUB operations can be used to set/clear the overflow flag in ALU.
- All ALU operations can be used to set/clear the zero flag in ALU.

### 30.4.1.2 Operations with Immediate Value



Figure 30-4. Instruction Type — ALU for Operations with Immediate Value

When bits [27:25] of the instruction in Figure 30-4 are set to 3'b1, ALU performs operations, using register R[0-3] and the immediate value stored in [19:4]. The types of operations depend on the setting of the instruction's bits [24:21] presented in Table 30-2.

**Operand**    **Description** - see Figure 30-4

*ALU\_sel*    Type of ALU operation

*Rdst*        Register R[0-3], destination

*Rsrc1*      Register R[0-3], source

*Imm*        16-bit signed value

ALU_sel	Instruction	Operation	Description
0	ADD	$Rdst = Rsrc1 + Imm$	Add to register
1	SUB	$Rdst = Rsrc1 - Imm$	Subtract from register
2	AND	$Rdst = Rsrc1 \& Imm$	Bitwise logical AND of two operands
3	OR	$Rdst = Rsrc1 \mid Imm$	Bitwise logical OR of two operands
4	MOVE	$Rdst = Imm$	Move to register
5	LSH	$Rdst = Rsrc1 \ll Imm$	Bit shifting left
6	RSH	$Rdst = Rsrc1 \gg Imm$	Bit shifting right

Table 30-2. ALU Operations with Immediate Value

**Note:**

- ADD/SUB operations can be used to set/clear the overflow flag in ALU.
- All ALU operations can be used to set/clear the zero flag in ALU.

### 30.4.1.3 Operations with Stage Count Register



Figure 30-5. Instruction Type — ALU for Operations with Stage Count Register

ALU is also able to increment/decrement by a given value, or reset the 8-bit register *Stage\_cnt*. To do so, bits [27:25] of instruction in Figure 30-5 should be set to 3'b2. The type of operation depends on the setting of the instruction's bits [24:21] presented in Table 30-3. The *Stage\_cnt* is a separate register and is not a part of the instruction in Figure 30-5.

**Operand**    **Description** - see Figure 30-5

*ALU\_sel*    Type of ALU operation

*Stage\_cnt*    Stage count register, a separate register [7:0] used to store variables, such as loop index

*Imm*        8-bit value

ALU_sel	Instruction	Operation	Description
0	STAGE_INC	$Stage\_cnt = Stage\_cnt + Imm$	Increment stage count register
1	STAGE_DEC	$Stage\_cnt = Stage\_cnt - Imm$	Decrement stage count register
2	STAGE_RST	$Stage\_cnt = 0$	Reset stage count register

Table 30-3. ALU Operations with Stage Count Register

### 30.4.2 ST – Store Data in Memory

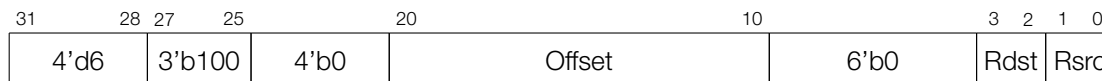


Figure 30-6. Instruction Type – ST

#### Operand Description - see Figure 30-6

*Offset* 10-bit signed value, offset expressed in 32-bit words

*Rsrc* Register R[0-3], 16-bit value to store

*Rdst* Register R[0-3], address of the destination, expressed in 32-bit words

#### Description

The instruction stores the 16-bit value of *Rsrc* in the lower half-word of memory with address  $Rdst + Offset$ . The upper half-word is written with the current program counter (PC) (expressed in words and shifted to the left by 5 bits) OR'd with *Rdst* (0..3):

$$\text{Mem} [ Rdst + Offset ] \{31:0\} = \{PC[10:0], 3'b0, Rdst, Rsrc[15:0]\}$$

The application can use the higher 16 bits to determine which instruction in the ULP program has written any particular word into memory.

#### Note:

- This instruction can only access 32-bit memory words.
- Data from *Rsrc* is always stored in the lower 16 bits of a memory word. Differently put, it is not possible to store *Rsrc* in the upper 16 bits of memory.
- The "Mem" written is the RTC\_SLOW\_MEM memory. Address 0, as seen by the ULP coprocessor, corresponds to address 0x50000000, as seen by the main CPUs.

### 30.4.3 LD – Load Data from Memory



Figure 30-7. Instruction Type – LD

#### Operand Description - see Figure 30-7

*Offset* 10-bit signed value, offset expressed in 32-bit words

*Rsrc* Register R[0-3], address of destination memory, expressed in 32-bit words

*Rdst* Register R[0-3], destination

#### Description

The instruction loads the lower 16-bit half-word from memory with address  $Rsrc + offset$  into the destination register  $Rdst$ :

$$Rdst[15:0] = Mem[ Rsrc + Offset ][15:0]$$

**Note:**

- This instruction can only access 32-bit memory words.
- In any case, it is always the lower 16 bits of a memory word that are loaded. Differently put, it is not possible to read the upper 16 bits.
- The "Mem" loaded is the RTC\_SLOW\_MEM memory. Address 0, as seen by the ULP coprocessor, corresponds to address 0x50000000, as seen by the main CPUs.

### 30.4.4 JUMP – Jump to an Absolute Address



Figure 30-8. Instruction Type – JUMP

**Operand Description** - see Figure 30-8

<i>Rdst</i>	Register R[0-3], address to jump to
<i>ImmAddr</i>	11-bit address, expressed in 32-bit words
<i>Sel</i>	Selects the address to jump to: 0 - jump to the address contained in <i>ImmAddr</i> 1 - jump to the address contained in <i>Rdst</i>
<i>Type</i>	Jump type: 0 - make an unconditional jump 1 - jump only if the last ALU operation has set the zero flag 2 - jump only if the last ALU operation has set the overflow flag

**Description**

The instruction prompts a jump to the specified address. The jump can be either unconditional or based on the ALU flag.

**Note:**

All jump addresses are expressed in 32-bit words.

### 30.4.5 JUMPR – Jump to a Relative Offset (Conditional upon R0)

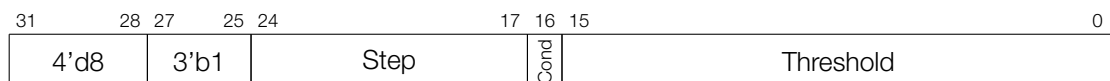


Figure 30-9. Instruction Type – JUMPR

**Operand Description** - see Figure 30-9

<i>Step</i>	Relative shift from current position, expressed in 32-bit words: if $\text{Step}[7] = 0$ then $\text{PC} = \text{PC} + \text{Step}[6:0]$ if $\text{Step}[7] = 1$ then $\text{PC} = \text{PC} - \text{Step}[6:0]$
<i>Threshold</i>	Threshold value for condition (see <i>Cond</i> below) to jump
<i>Cond</i>	Condition to jump: 0 - jump if $\text{R0} < \text{Threshold}$ 1 - jump if $\text{R0} \geq \text{Threshold}$

**Description**

The instruction prompts a jump to a relative address, if the above-mentioned condition is true. The condition itself is the result of comparing the R0 register value and the *Threshold* value.

**Note:**

All jump addresses are expressed in 32-bit words.

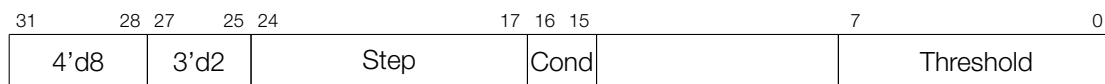
**30.4.6 JUMPS – Jump to a Relative Address (Conditional upon Stage Count Register)**

Figure 30-10. Instruction Type – JUMP

**Operand Description** - see Figure 30-10

<i>Step</i>	Relative shift from current position, expressed in 32-bit words: if $\text{Step}[7] = 0$ , then $\text{PC} = \text{PC} + \text{Step}[6:0]$ if $\text{Step}[7] = 1$ , then $\text{PC} = \text{PC} - \text{Step}[6:0]$
<i>Threshold</i>	Threshold value for condition (see <i>Cond</i> below) to jump
<i>Cond</i>	Condition of jump: 1X - jump if $\text{Stage\_cnt} \leq \text{Threshold}$ 00 - jump if $\text{Stage\_cnt} < \text{Threshold}$ 01 - jump if $\text{Stage\_cnt} \geq \text{Threshold}$

**Note:**

- A description of how to set the stage count register is provided in section 30.4.1.3.
- All jump addresses are expressed in 32-bit words.

**Description**

The instruction prompts a jump to a relative address if the above-mentioned condition is true. The condition itself is the result of comparing the value of *Stage\_cnt* (stage count register) and the *Threshold* value.

**30.4.7 HALT – End the Program**

Figure 30-11. Instruction Type – HALT

**Description**

The instruction ends the operation of the processor and puts it into power-down mode.

**Note:**

After executing this instruction, the ULP coprocessor timer gets started.

### 30.4.8 WAKE – Wake up the Chip



Figure 30-12. Instruction Type – WAKE

**Description**

This instruction sends an interrupt from the ULP coprocessor to the RTC controller.

- If the SoC is in Deep-sleep mode, and the ULP wake-up is enabled, the above-mentioned interrupt will wake up the SoC.
- If the SoC is not in Deep-sleep mode, and the ULP interrupt bit (RTC\_CNTL\_ULP\_CP\_INT\_ENA) is set in register RTC\_CNTL\_INT\_ENA\_REG, a RTC interrupt will be triggered.

### 30.4.9 Sleep – Set the ULP Timer's Wake-up Period



Figure 30-13. Instruction Type – SLEEP

**Operand**    **Description** - see Figure 30-13

*sleep\_reg*    Selects one of five `SENS_ULP_CP_SLEEP_CYC $n$ _REG` ( $n$ : 0-4) as the wake-up period of the ULP coprocessor

**Description**

The instruction selects which one of the `SENS_ULP_CP_SLEEP_CYC $n$ _REG` ( $n$ : 0-4) register values is to be used by the ULP timer as the wake-up period. By default, the value of `SENS_ULP_CP_SLEEP_CYC0_REG` is used.

### 30.4.10 WAIT – Wait for a Number of Cycles

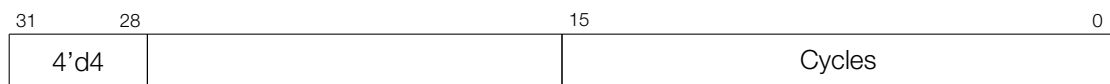


Figure 30-14. Instruction Type – WAIT

**Operand**    **Description** - see Figure 30-14

*Cycles*        the number of cycles to wait between sleeps

**Description**

The instruction will delay the ULP coprocessor from getting into sleep for a certain number of *Cycles*.



### 30.4.11 ADC – Take Measurement with ADC



Figure 30-15. Instruction Type – ADC

**Operand Description** - see Figure 30-15

*Rdst* Destination Register R[0-3], results will be stored in this register.

*Sel* Selected ADC: 0 = SAR ADC1, 1 = SAR ADC2, see Table 30-4.

*Sar Mux* SARADC Pad [Sar\_Mux - 1] is enabled, see Table 30-4.

Table 30-4. Input Signals Measured Using the ADC Instruction

Pad Name/Signal/GPIO	<i>Sar_Mux</i>	Processed by / <i>Sel</i>
SENSOR_VP (GPIO36)	1	SAR ADC1/ <i>Sel</i> = 0
SENSOR_CAPP (GPIO37)	2	
SENSOR_CAPN (GPIO38)	3	
SENSOR_VN (GPIO39)	4	
32K_XP (GPIO33)	5	
32K_XN (GPIO32)	6	
VDET_1 (GPIO34)	7	
VDET_2 (GPIO35)	8	
Hall phase 1	9	
Hall phase 0	10	
GPIO4	1	SAR ADC2/ <i>Sel</i> = 1
GPIO0	2	
GPIO2	3	
MTDO (GPIO15)	4	
MTCK (GPIO13)	5	
MTDI (GPIO12)	6	
MTMS (GPIO14)	7	
GPIO27	8	
GPIO25	9	
GPIO26	10	

#### Description

The instruction prompts the taking of measurements with the use of ADC. Pads/signals available for ADC measurement are provided in Table 30-4.

### 30.4.12 I2C\_RD/I2C\_WR – Read/Write I<sup>2</sup>C

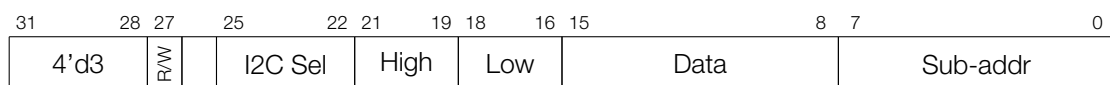


Figure 30-16. Instruction Type – I<sup>2</sup>C

**Operand Description** - see Figure 30-16

<i>Sub-addr</i>	Slave register address
<i>Data</i>	Data to write in I2C_WR operation (not used in I2C_RD operation)
<i>Low</i>	High part of bit mask
<i>High</i>	Low part of bit mask
<i>I2C Sel</i>	Select register <i>n</i> of <code>SENS_I2C_SLAVE_ADDRn</code> ( <i>n</i> : 0-7), which contains the I <sup>2</sup> C slave address.
<i>R/W</i>	I <sup>2</sup> C communication direction: 1 - I <sup>2</sup> C write 0 - I <sup>2</sup> C read

**Description**

Communicate (read/write) with external I<sup>2</sup>C slave devices. Details on using the RTC I<sup>2</sup>C peripheral are provided in section 30.6.

**Note:**

When working in master mode, RTC\_I2C samples the SDA input on the negative edge of SCL.

**30.4.13 REG\_RD – Read from Peripheral Register**

Figure 30-17. Instruction Type – REG\_RD

**Operand Description** - see Figure 30-17

<i>Addr</i>	Register address, expressed in 32-bit words
<i>High</i>	Register end bit number
<i>Low</i>	Register start bit number

**Description**

The instruction prompts a read of up to 16 bits from a peripheral register into a general-purpose register R0:

$$R0 = \text{REG}[\text{Addr}][\text{High}:\text{Low}]$$

In case of more than 16 bits being requested, i.e.  $\text{High} - \text{Low} + 1 > 16$ , then the instruction will return  $[\text{Low}+15:\text{Low}]$ .

**Note:**

- This instruction can access registers in RTC\_CNTL, RTC\_IO, SENS and RTC\_I2C peripherals. The address of the register, as seen from the ULP coprocessor, can be calculated from the address of the same register on the DPORT bus, as follows:

$$\text{addr\_ulp} = (\text{addr\_dport} - \text{DR\_REG\_RTCCNTL\_BASE})/4$$

- The *addr\_ulp* is expressed in 32-bit words (not in bytes), and value 0 maps onto the DR\_REG\_RTCCNTL\_BASE (as seen from the main CPUs). Thus, 10 bits of address cover a 4096-byte range of peripheral register space, including regions DR\_REG\_RTCCNTL\_BASE, DR\_REG\_RTCIO\_BASE, DR\_REG\_SENS\_BASE and DR\_REG\_RTC\_I2C\_BASE.

### 30.4.14 REG\_WR – Write to Peripheral Register

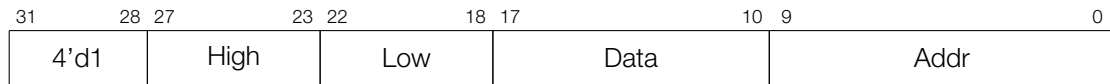


Figure 30-18. Instruction Type – REG\_WR

**Operand**    **Description** - see Figure 30-18

*Addr*        Register address, expressed in 32-bit words

*High*        Register end bit number

*Low*         Register start bit number

*Data*        Value to write, 8 bits

#### Description

The instruction prompts the writing of up to 8 bits from an immediate data value into a peripheral register.

$$\text{REG}[\text{Addr}][\text{High}:\text{Low}] = \text{Data}$$

If more than 8 bits are requested, i.e.  $\text{High} - \text{Low} + 1 > 8$ , then the instruction will pad with zeros the bits above the eighth bit.

#### Note:

See notes regarding *addr\_ulp* in section 30.4.13 above.

## 30.5 ULP Program Execution

The ULP coprocessor is designed to operate independently of the main CPUs, while they are either in deep sleep or running.

In a typical power-saving scenario, the ULP coprocessor operates while the main CPUs are in deep sleep. To save power even further, the ULP coprocessor can get into sleep mode, as well. In such a scenario, there is a specific hardware timer in place to wake up the ULP coprocessor, since there is no software program running at the same time. This timer should be configured in advance by setting and then selecting one of the [SENS\\_ULP\\_CP\\_SLEEP\\_CYC<sub>n</sub>\\_REG](#) registers that contain the expiration period. This can be done either by the main program, or the ULP program with the [REG\\_WR](#) and [SLEEP](#) instructions. Then, the ULP timer should be enabled by setting bit `RTC_CNTL_ULP_CP_SLP_TIMER_EN` in the `RTC_CNTL_STATE0_REG` register.

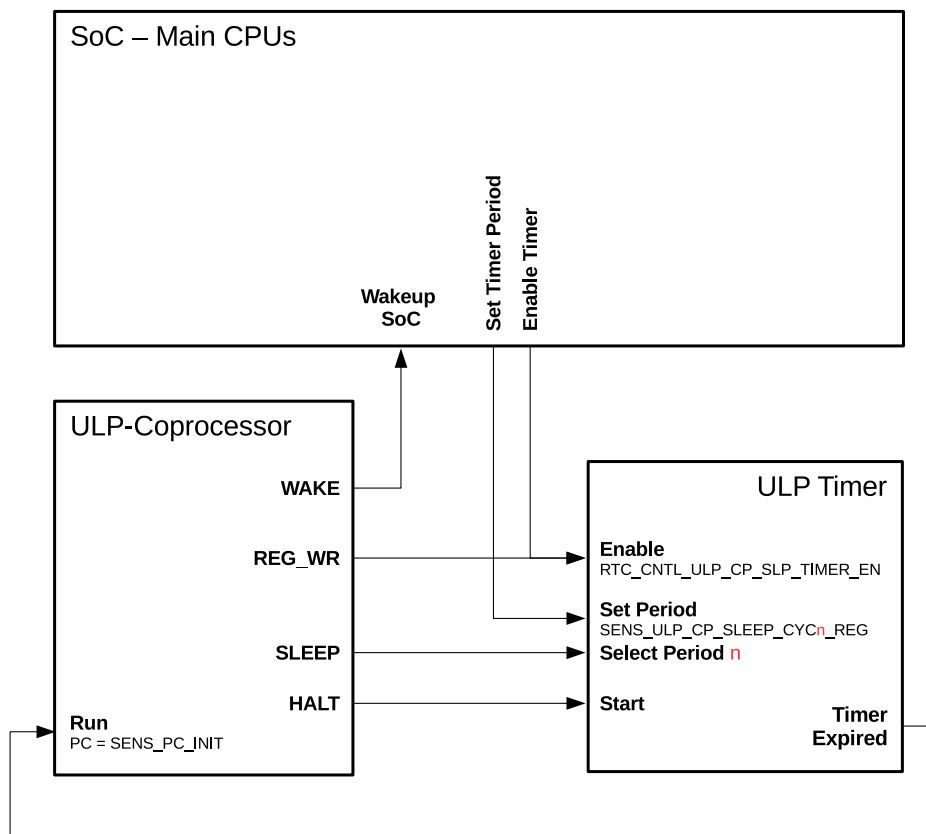


Figure 30-19. Control of ULP Program Execution

The ULP coprocessor puts itself into sleep mode by executing the `HALT` instruction. This also triggers the ULP timer to start counting `RTC_SLOW_CLK` ticks which, by default, originate from an internal 150 kHz RC oscillator. Once the timer expires, the ULP coprocessor is powered up and runs a program with the program counter (PC) which is stored in register `SENS_PC_INIT`. The relationship between the described signals and registers is shown in Figure 30-19.

On reset or power-up the above-mentioned ULP program may start up only after the expiration of `SENS_ULP_CP_SLEEP_CYC0_REG`, which is the default selection period of the ULP timer.

A sample operation sequence of the ULP program is shown in Figure 30-20, where the following steps are executed:

1. Software enables the ULP timer by using bit `RTC_CNTL_ULP_CP_SLP_TIMER_EN`.
2. The ULP timer expires and the ULP coprocessor starts running the program at `PC = SENS_PC_INIT`.
3. The ULP program executes the `HALT` instruction; the ULP coprocessor is halted and the timer gets restarted.
4. The ULP program executes the `SLEEP` instruction to change the sleep timer period register.
5. The ULP program, or software, disables the ULP timer by using bit `RTC_CNTL_ULP_CP_SLP_TIMER_EN`.

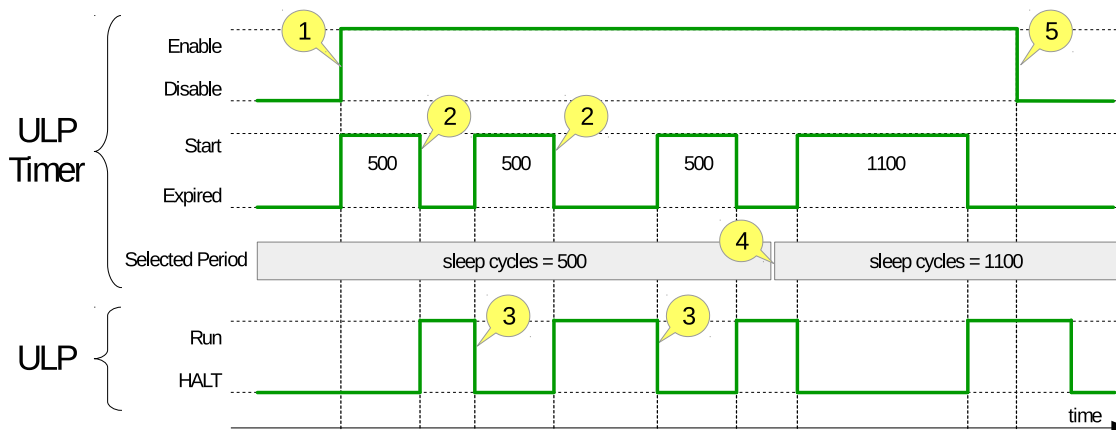


Figure 30-20. Sample of a ULP Operation Sequence

The specific timing of the wakeup, program execution and sleep sequence is governed by the ULP FSM as follows:

1. On the ULP timer expiration the FSM wakes up the ULP and this process takes two clock cycles.
2. Then, before executing the program, the FSM waits for the number of cycles configured in `RTC_CNTL_ULPCP_TOUCH_START_WAIT` field of the `RTC_CNTL_TIMER2_REG` register. This time is spent waiting for the 8 MHz clock to get stable.
3. The ULP program is executed.
4. After calling HALT instruction, the program is stopped. The FSM requires additional two clock cycles to put the ULP to sleep.

## 30.6 RTC\_I2C Controller

The ULP coprocessor can use a separate I<sup>2</sup>C controller, located in the RTC domain, to communicate with external I<sup>2</sup>C slave devices. RTC\_I2C has a limited feature set, compared to I2C0/I2C1 peripherals.

### 30.6.1 Configuring RTC\_I2C

Before the ULP coprocessor can use the I<sup>2</sup>C instruction, certain parameters of the RTC\_I2C need to be configured. This can be done by the program running on one of the main CPUs, or by the ULP coprocessor itself. Configuration is performed by writing certain timing parameters into the RTC\_I2C registers:

1. Set the low and high SCL half-periods by using `RTC_I2C_SCL_LOW_PERIOD_REG` and `RTC_I2C_SCL_HIGH_PERIOD_REG` in RTC\_FAST\_CLK cycles (e.g. `RTC_I2C_SCL_LOW_PERIOD=40`, `RTC_I2C_SCL_HIGH_PERIOD=40` for 100 kHz frequency).
2. Set the number of cycles between the SDA switch and the falling edge of SCL by using `RTC_I2C_SDA_DUTY_REG` in RTC\_FAST\_CLK (e.g. `RTC_I2C_SDA_DUTY=16`).
3. Set the waiting time after the START condition by using `RTC_I2C_SCL_START_PERIOD_REG` (e.g. `RTC_I2C_SCL_START_PERIOD=30`).
4. Set the waiting time before the END condition by using `RTC_I2C_SCL_STOP_PERIOD_REG` (e.g. `RTC_I2C_SCL_STOP_PERIOD=44`).

5. Set the transaction timeout by using [RTC\\_I2C\\_TIMEOUT\\_REG](#) (e.g. `RTC_I2C_TIMEOUT=200`).
6. Enable the master mode (set the `RTC_I2C_MS_MODE` bit in [RTC\\_I2C\\_CTRL\\_REG](#)).
7. Write the address(es) of external slave(s) to [SENS\\_I2C\\_SLAVE\\_ADDR \$n\$](#)  ( $n$ : 0-7). Up to eight slave addresses can be pre-programmed this way. One of these addresses can then be selected for each transaction as part of the ULP I<sup>2</sup>C instruction.

Once `RTC_I2C` is configured, instructions [ULP I2C\\_RD](#) and [I2C\\_WR](#) can be used.

### 30.6.2 Using RTC\_I2C

The ULP coprocessor supports two instructions (with a single OpCode) for using `RTC_I2C`: [I2C\\_RD](#) (read) and [I2C\\_WR](#) (write).

#### 30.6.2.1 I2C\_RD - Read a Single Byte

The `I2C_RD` instruction performs the following I<sup>2</sup>C transaction (see Figure 30-21):

1. Master generates a START condition.
2. Master sends slave address, with r/w bit set to 0 (“write”). Slave address is obtained from [SENS\\_I2C\\_SLAVE\\_ADDR \$n\$](#) , where  $n$  is given as an argument to the `I2C_RD` instruction.
3. Slave generates ACK.
4. Master sends slave register address (given as an argument to the `I2C_RD` instruction).
5. Slave generates ACK.
6. Master generates a repeated START condition.
7. Master sends slave address, with r/w bit set to 1 (“read”).
8. Slave sends one byte of data.
9. Master generates NACK.
10. Master generates a STOP condition.

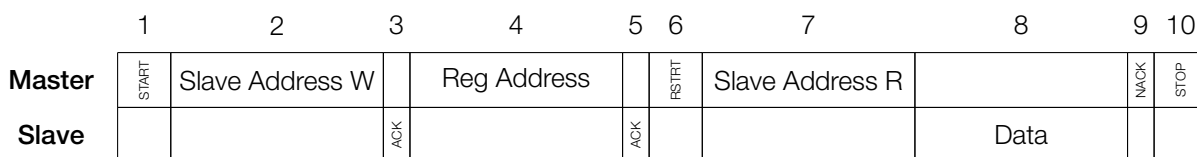


Figure 30-21. I<sup>2</sup>C Read Operation

#### Note:

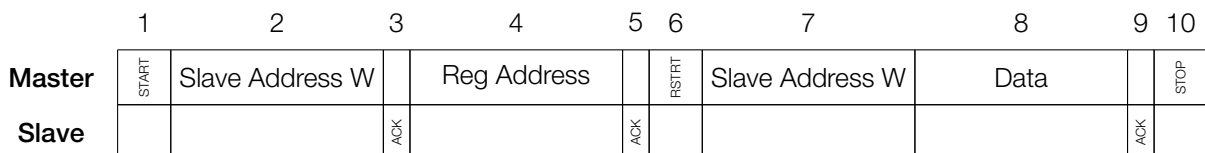
The `RTC_I2C` peripheral samples the SDA signals on the falling edge of SCL. If the slave changes SDA in less than 0.38 microseconds, the master will receive incorrect data.

The byte received from the slave is stored into the `R0` register.

#### 30.6.2.2 I2C\_WR - Write a Single Byte

The `I2C_WR` instruction performs the following I<sup>2</sup>C transaction (see Figure 30-22):

1. Master generates a START condition.
2. Master sends slave address, with r/w bit set to 0 (“write”). Slave address is obtained from `SENS_I2C_SLAVE_ADDR $n$` , where  $n$  is given as an argument to the `I2C_WR` instruction.
3. Slave generates ACK.
4. Master sends slave register address (given as an argument to the `I2C_WR` instruction).
5. Slave generates ACK.
6. Master generates a repeated START condition.
7. Master sends slave address, with r/w bit set to 0 (“write”).
8. Master sends one byte of data.
9. Slave generates ACK.
10. Master generates a STOP condition.

Figure 30-22. I<sup>2</sup>C Write Operation

### 30.6.2.3 Detecting Error Conditions

ULP `I2C_RD` and `I2C_WR` instructions will not report error conditions, such as a NACK from a slave, via ULP registers. Instead, applications can query specific bits in the `RTC_I2C_INT_ST_REG` register to determine if the transaction was successful. To enable checking for specific communication events, their corresponding bits should be set in register `RTC_I2C_INT_EN_REG`. Note that the bit map is shifted by 1. If a specific communication event is detected and set in register `RTC_I2C_INT_ST_REG`, it can then be cleared using `RTC_I2C_INT_CLR_REG`.

### 30.6.2.4 Connecting I<sup>2</sup>C Signals

SDA and SCL signals can be mapped onto two out of the four GPIO pins, which are identified in Table `RTC_MUX Pin Summary` in Chapter *IO\_MUX and GPIO Matrix*, using the `RTCIO_SAR_I2C_IO_REG` register.

## 30.7 Register Summary

### 30.7.1 SENS\_ULP Address Space

Name	Description	Address	Access
<b>ULP Timer cycles select</b>			
<code>SENS_ULP_CP_SLEEP_CYC0_REG</code>	Timer cycles setting 0	0x3FF48818	R/W
<code>SENS_ULP_CP_SLEEP_CYC1_REG</code>	Timer cycles setting 1	0x3FF4881C	R/W
<code>SENS_ULP_CP_SLEEP_CYC2_REG</code>	Timer cycles setting 2	0x3FF48820	R/W
<code>SENS_ULP_CP_SLEEP_CYC3_REG</code>	Timer cycles setting 3	0x3FF48824	R/W
<code>SENS_ULP_CP_SLEEP_CYC4_REG</code>	Timer cycles setting 4	0x3FF48828	R/W

RTC I2C slave address select			
<a href="#">SENS_SAR_SLAVE_ADDR1_REG</a>	I2C addresses 0 and 1	0x3FF4883C	R/W
<a href="#">SENS_SAR_SLAVE_ADDR2_REG</a>	I2C addresses 2 and 3	0x3FF48840	R/W
<a href="#">SENS_SAR_SLAVE_ADDR3_REG</a>	I2C addresses 4 and 5	0x3FF48844	R/W
<a href="#">SENS_SAR_SLAVE_ADDR4_REG</a>	I2C addresses 6 and 7, I2C control	0x3FF48848	R/W
RTC I2C control			
<a href="#">SENS_SAR_I2C_CTRL_REG</a>	I2C control registers	0x3FF48850	R/W

### 30.7.2 RTC\_I2C Address Space

Name	Description	Address	Access
RTC I2C control registers			
<a href="#">RTC_I2C_CTRL_REG</a>	Transmission setting	0x3FF48C04	R/W
<a href="#">RTC_I2C_DEBUG_STATUS_REG</a>	Debug status	0x3FF48C08	R/W
<a href="#">RTC_I2C_TIMEOUT_REG</a>	Timeout setting	0x3FF48C0C	R/W
<a href="#">RTC_I2C_SLAVE_ADDR_REG</a>	Local slave address setting	0x3FF48C10	R/W
RTC I2C signal setting registers			
<a href="#">RTC_I2C_SDA_DUTY_REG</a>	Configures the SDA hold time after a negative SCL edge	0x3FF48C30	R/W
<a href="#">RTC_I2C_SCL_LOW_PERIOD_REG</a>	Configures the low level width of SCL	0x3FF48C00	R/W
<a href="#">RTC_I2C_SCL_HIGH_PERIOD_REG</a>	Configures the high level width of SCL	0x3FF48C38	R/W
<a href="#">RTC_I2C_SCL_START_PERIOD_REG</a>	Configures the delay between the SDA and SCL negative edge for a start condition	0x3FF48C40	R/W
<a href="#">RTC_I2C_SCL_STOP_PERIOD_REG</a>	Configures the delay between the SDA and SCL positive edge for a stop condition	0x3FF48C44	R/W
RTC I2C interrupt registers - listed only for debugging			
<a href="#">RTC_I2C_INT_CLR_REG</a>	Clear status of I2C communication events	0x3FF48C24	R/W
<a href="#">RTC_I2C_INT_EN_REG</a>	Enable capture of I2C communication status events	0x3FF48C28	R/W
<a href="#">RTC_I2C_INT_ST_REG</a>	Status of captured I2C communication events	0x3FF48C2C	R/O

**Note:**

Interrupts from RTC\_I2C are not connected. The interrupt registers above are listed only for [debugging](#) purposes.



## 30.8 Registers

### 30.8.1 SENS\_ULP Address Space

The addresses in parenthesis besides register names are the register addresses relative to (the RTC base address + 0x0800). The RTC base address is provided in Table 1-6 *Peripheral Address Mapping* in Chapter 1 *System and Memory*. The absolute register addresses are listed in Section 30.7.1 *SENS\_ULP Address Space*.

**Register 30.1. SENS\_ULP\_CP\_SLEEP\_CYC $n$ \_REG ( $n$ : 0-4) (0x18+0x4\* $n$ )**

31	0
20	

Reset

**SENS\_ULP\_CP\_SLEEP\_CYC $n$ \_REG** ULP timer cycles setting  $n$ ; the ULP coprocessor can select one of such registers by using the SLEEP instruction. (R/W)

**Register 30.2. SENS\_SAR\_START\_FORCE\_REG (0x002c)**

(reserved)										SENS_PC_INIT										(reserved)				SENS_ULP_CP_START_TOP SENS_ULP_CP_FORCE_START_TOP				(reserved)				
31											22	21											11	10	9	8	7					0
0 0 0 0 0 0 0 0 0 0										0 0 0 0 0 0 0 0 0 0 0 0 0 0 0 0 0 0 0 0										0 0 0 0				0 0 0 0 0 0 0 0 0 0 0 0				0				

Reset

**SENS\_PC\_INIT** ULP PC entry address. (R/W)

**SENS\_ULP\_CP\_START\_TOP** Set this bit to start the ULP coprocessor; it is active only when SENS\_ULP\_CP\_FORCE\_START\_TOP = 1. (R/W)

**SENS\_ULP\_CP\_FORCE\_START\_TOP** 1: ULP coprocessor is started by SENS\_ULP\_CP\_START\_TOP; 0: ULP coprocessor is started by timer. (R/W)

**Register 30.3. SENS\_SAR\_SLAVE\_ADDR1\_REG (0x003c)**

(reserved)										SENS_I2C_SLAVE_ADDR0										SENS_I2C_SLAVE_ADDR1									
31											22	21											11	10					0
0 0 0 0 0 0 0 0 0 0										0x000										0x000				0					

Reset

**SENS\_I2C\_SLAVE\_ADDR0** I2C slave address 0. (R/W)

**SENS\_I2C\_SLAVE\_ADDR1** I2C slave address 1. (R/W)

## Register 30.4. SENS\_SAR\_SLAVE\_ADDR2\_REG (0x0040)

(reserved)										SENS_I2C_SLAVE_ADDR2											SENS_I2C_SLAVE_ADDR3											
31										22	21										11	10										0
0	0	0	0	0	0	0	0	0	0	0x000									0x000									Reset				

**SENS\_I2C\_SLAVE\_ADDR2** I2C slave address 2. (R/W)

**SENS\_I2C\_SLAVE\_ADDR3** I2C slave address 3. (R/W)

## Register 30.5. SENS\_SAR\_SLAVE\_ADDR3\_REG (0x0044)

(reserved)										SENS_I2C_SLAVE_ADDR4											SENS_I2C_SLAVE_ADDR5											
31										22	21										11	10										0
0	0	0	0	0	0	0	0	0	0	0x000									0x000									Reset				

**SENS\_I2C\_SLAVE\_ADDR4** I2C slave address 4. (R/W)

**SENS\_I2C\_SLAVE\_ADDR5** I2C slave address 5. (R/W)

## Register 30.6. SENS\_SAR\_SLAVE\_ADDR4\_REG (0x0048)

(reserved)										SENS_I2C_DONE										SENS_I2C_RDATA										SENS_I2C_SLAVE_ADDR6											SENS_I2C_SLAVE_ADDR7										
31	30	29								22	21										11	10										0																			
0	0	0x000							0x000									0x000									Reset																								

**SENS\_I2C\_DONE** Indicate I2C done. (RO)

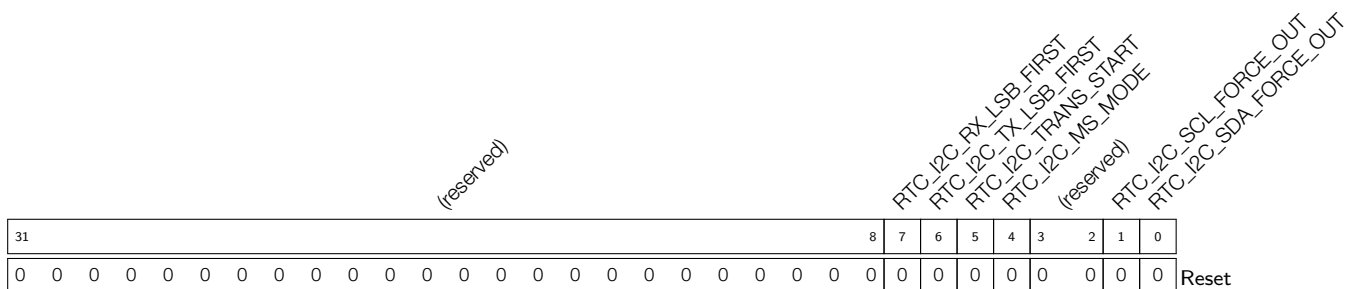
**SENS\_I2C\_RDATA** I2C read data. (RO)

**SENS\_I2C\_SLAVE\_ADDR6** I2C slave address 6. (R/W)

**SENS\_I2C\_SLAVE\_ADDR7** I2C slave address 7. (R/W)

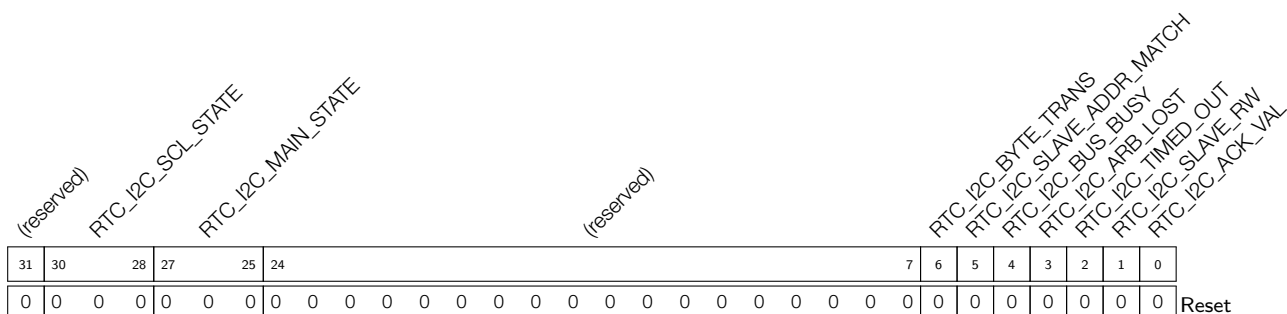


**Register 30.9. RTC\_I2C\_CTRL\_REG (0x004)**



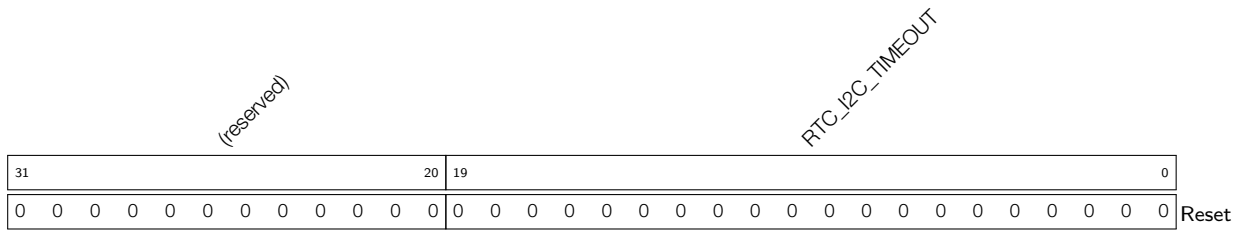
- RTC\_I2C\_RX\_LSB\_FIRST** Receive LSB first. (R/W)
- RTC\_I2C\_TX\_LSB\_FIRST** Send LSB first. (R/W)
- RTC\_I2C\_TRANS\_START** Force to generate a start condition. (R/W)
- RTC\_I2C\_MS\_MODE** Master (1), or slave (0). (R/W)
- RTC\_I2C\_SCL\_FORCE\_OUT** SCL is push-pull (1) or open-drain (0). (R/W)
- RTC\_I2C\_SDA\_FORCE\_OUT** SDA is push-pull (1) or open-drain (0). (R/W)

**Register 30.10. RTC\_I2C\_DEBUG\_STATUS\_REG (0x008)**



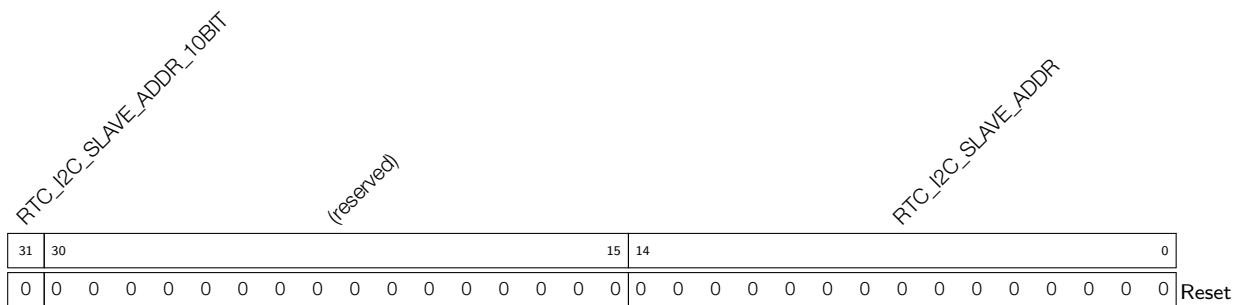
- RTC\_I2C\_SCL\_STATE** State of SCL machine. (R/W)
- RTC\_I2C\_MAIN\_STATE** State of the main machine. (R/W)
- RTC\_I2C\_BYTE\_TRANS** 8-bit transmit done. (R/W)
- RTC\_I2C\_SLAVE\_ADDR\_MATCH** Indicates whether the addresses are matched, when in slave mode. (R/W)
- RTC\_I2C\_BUS\_BUSY** Operation is in progress. (R/W)
- RTC\_I2C\_ARB\_LOST** Indicates the loss of I2C bus control, when in master mode. (R/W)
- RTC\_I2C\_TIMED\_OUT** Transfer has timed out. (R/W)
- RTC\_I2C\_SLAVE\_RW** Indicates the value of the received R/W bit, when in slave mode. (R/W)
- RTC\_I2C\_ACK\_VAL** The value of ACK signal on the bus. (R/W)

**Register 30.11. RTC\_I2C\_TIMEOUT\_REG (0x00c)**



**RTC\_I2C\_TIMEOUT** Maximum number of RTC\_FAST\_CLK cycles that the transmission can take. (R/W)

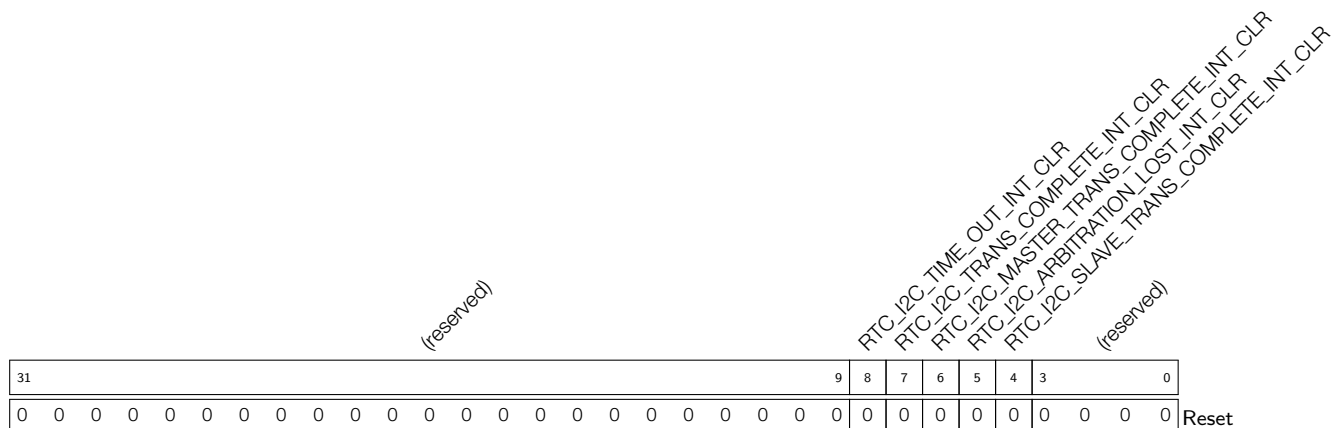
**Register 30.12. RTC\_I2C\_SLAVE\_ADDR\_REG (0x010)**



**RTC\_I2C\_SLAVE\_ADDR\_10BIT** Set if local slave address is 10-bit. (R/W)

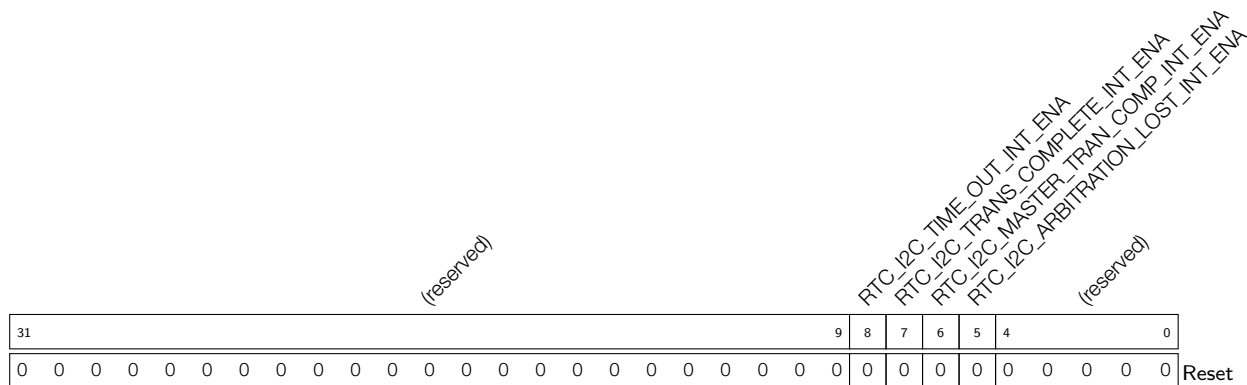
**RTC\_I2C\_SLAVE\_ADDR** Local slave address. (R/W)

**Register 30.13. RTC\_I2C\_INT\_CLR\_REG (0x024)**



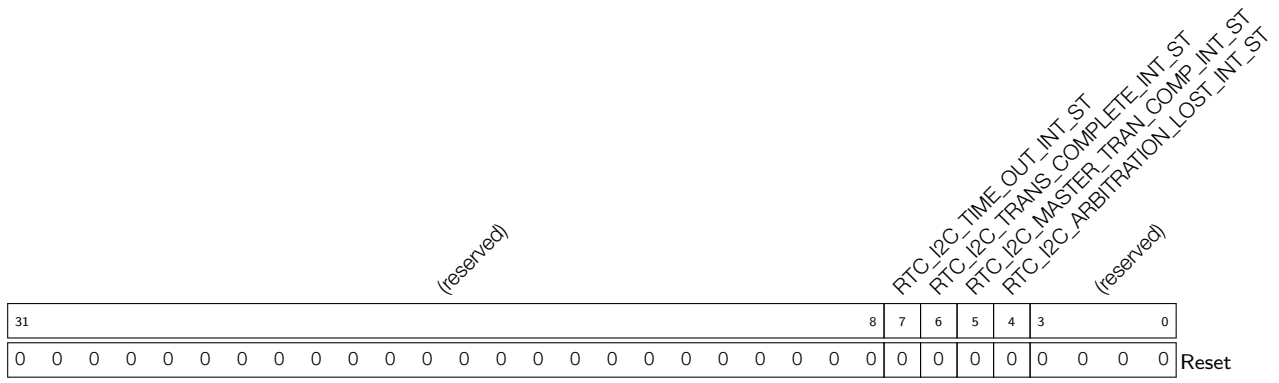
- RTC\_I2C\_TIME\_OUT\_INT\_CLR** Clear interrupt upon timeout. (R/W)
- RTC\_I2C\_TRANS\_COMPLETE\_INT\_CLR** Clear interrupt upon detecting a stop pattern. (R/W)
- RTC\_I2C\_MASTER\_TRANS\_COMPLETE\_INT\_CLR** Clear interrupt upon completion of transaction, when in master mode. (R/W)
- RTC\_I2C\_ARBITRATION\_LOST\_INT\_CLR** Clear interrupt upon losing control of the bus, when in master mode. (R/W)
- RTC\_I2C\_SLAVE\_TRANS\_COMPLETE\_INT\_CLR** Clear interrupt upon completion of transaction, when in slave mode. (R/W)

**Register 30.14. RTC\_I2C\_INT\_EN\_REG (0x028)**



- RTC\_I2C\_TIME\_OUT\_INT\_ENA** Enable interrupt upon timeout. (R/W)
- RTC\_I2C\_TRANS\_COMPLETE\_INT\_ENA** Enable interrupt upon detecting a stop pattern. (R/W)
- RTC\_I2C\_MASTER\_TRAN\_COMP\_INT\_ENA** Enable interrupt upon completion of transaction, when in master mode. (R/W)
- RTC\_I2C\_ARBITRATION\_LOST\_INT\_ENA** Enable interrupt upon losing control of the bus, when in master mode. (R/W)

**Register 30.15. RTC\_I2C\_INT\_ST\_REG (0x02c)**



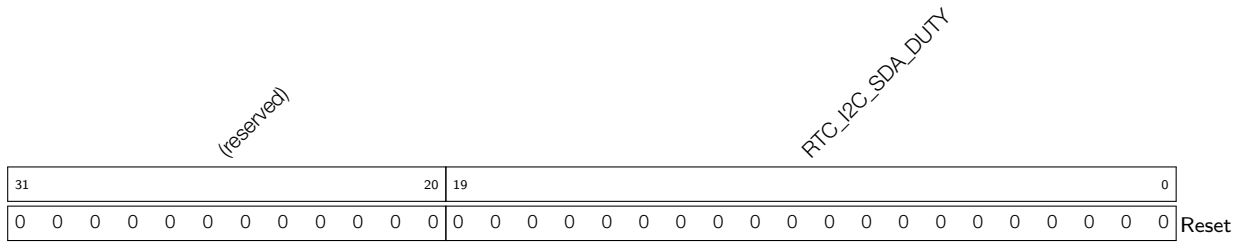
**RTC\_I2C\_TIME\_OUT\_INT\_ST** Detected timeout. (R/O)

**RTC\_I2C\_TRANS\_COMPLETE\_INT\_ST** Detected stop pattern on I2C bus. (R/O)

**RTC\_I2C\_MASTER\_TRAN\_COMP\_INT\_ST** Transaction completed, when in master mode. (R/O)

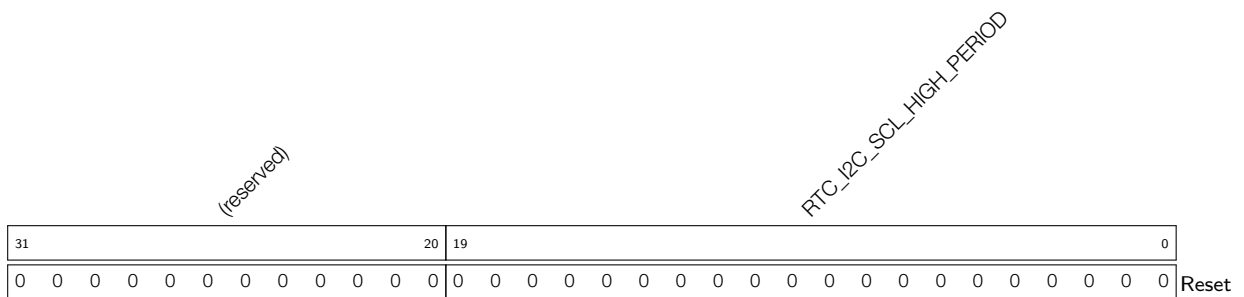
**RTC\_I2C\_ARBITRATION\_LOST\_INT\_ST** Bus control lost, when in master mode. (R/O)

**Register 30.16. RTC\_I2C\_SDA\_DUTY\_REG (0x030)**



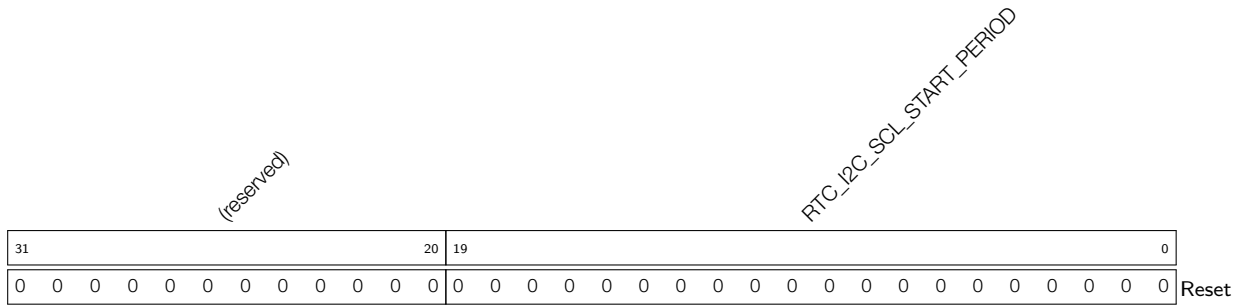
**RTC\_I2C\_SDA\_DUTY** Number of RTC\_FAST\_CLK cycles between the SDA switch and the falling edge of SCL. (R/W)

**Register 30.17. RTC\_I2C\_SCL\_HIGH\_PERIOD\_REG (0x038)**



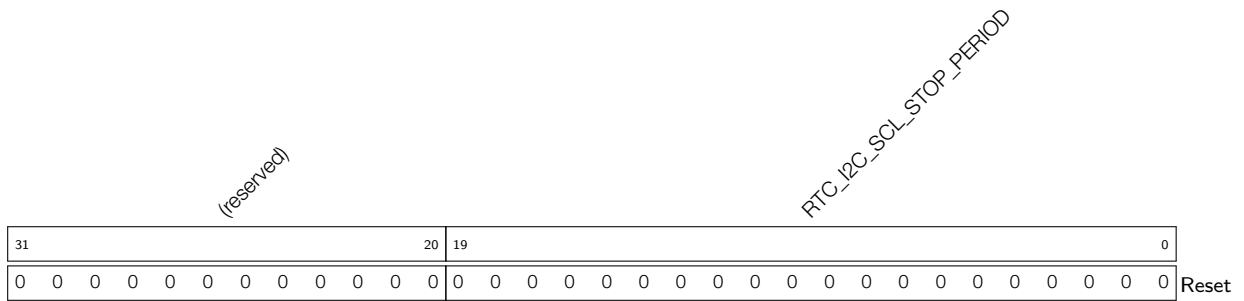
**RTC\_I2C\_SCL\_HIGH\_PERIOD** Number of RTC\_FAST\_CLK cycles when SCL == 1. (R/W)

**Register 30.18. RTC\_I2C\_SCL\_START\_PERIOD\_REG (0x040)**



**RTC\_I2C\_SCL\_START\_PERIOD** Number of RTC\_FAST\_CLK cycles to wait before generating a start condition. (R/W)

**Register 30.19. RTC\_I2C\_SCL\_STOP\_PERIOD\_REG (0x044)**



**RTC\_I2C\_SCL\_STOP\_PERIOD** Number of RTC\_FAST\_CLK cycles to wait before generating a stop condition. (R/W)



## 31 Low-Power Management (RTC\_CNTL)

### 31.1 Introduction

ESP32 offers efficient and flexible power-management technology to achieve the best balance between power consumption, wakeup latency and available wakeup sources. Users can select out of five predefined power modes of the main processors to suit specific needs of the application. In addition, to save power in power-sensitive applications, control may be executed by the Ultra-Low-Power coprocessor (ULP coprocessor), while the main processors are in Deep-sleep mode.

### 31.2 Features

- Five predefined power modes to support various applications
- Up to 16 KB of retention memory
- 8 x 32 bits of retention registers
- ULP coprocessor enabled in all low-power modes
- RTC boot supported to shorten the wakeup latency

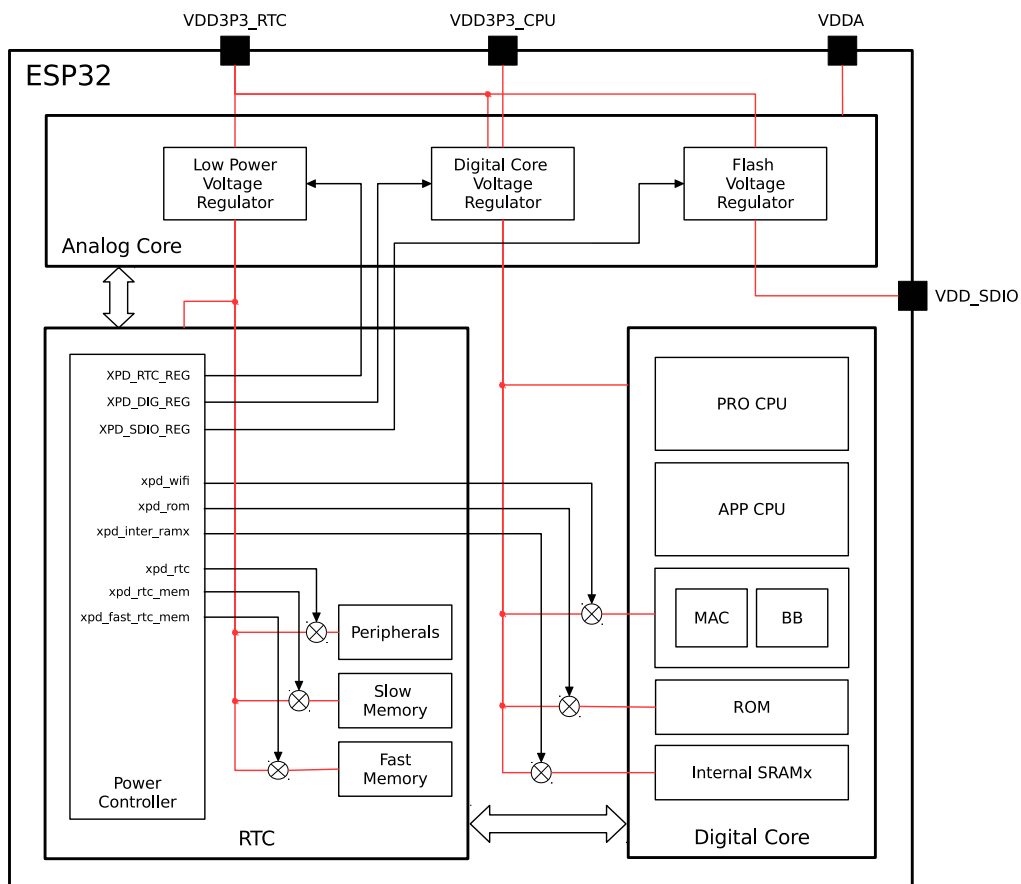


Figure 31-1. ESP32 Power Control

### 31.3 Functional Description

### 31.3.1 Overview

The low-power management unit includes voltage regulators, a power controller, power switch cells, power domain isolation cells, etc. Figure 31-1 shows the high-level architecture of ESP32's low-power management.

### 31.3.2 Digital Core Voltage Regulator

The built-in voltage regulator can convert the external power supply (typically 3.3V) to 1.1V to support the internal digital core. It receives a wide range of external power supply from 1.8V to 3.6V, and provides an output voltage from 0.90V to 1.25V.

1. When `XPD_DIG_REG == 1`, the regulator outputs a 1.1V voltage and the digital core is able to run; when `XPD_DIG_REG == 0`, both the regulator and the digital core stop running.
2. `DIG_REG_DBIAS[2:0]` tunes the supply voltage of the digital core:

$$VDD\_DIG = 0.90 + DBIAS \cdot 0.05V$$

3. The current to the digital core comes from pin `VDD3P3_CPU` and pin `VDD3P3_RTC`.

Figure 31-2 shows the structure of a digital core's voltage regulator.

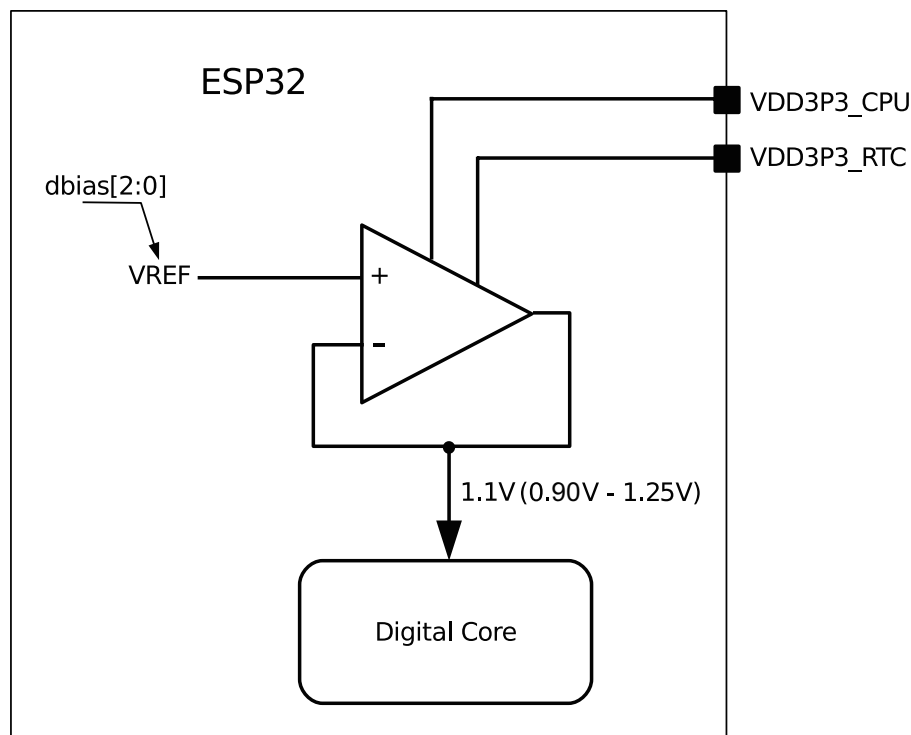


Figure 31-2. Digital Core Voltage Regulator

### 31.3.3 Low-Power Voltage Regulator

The built-in low-power voltage regulator can convert the external power supply (typically 3.3V) to 1.1V to support the internal RTC core. To save power, it receives a wide range of external power supply from 1.8V to 3.6V, and supports an adjustable output voltage of 0.90V to 1.25V in normal work mode, a fixed output voltage of about 0.75V both in Deep-sleep mode and Hibernation mode.

1. When the pin `CHIP_PU` is at a high level, the low-power voltage regulator cannot be turned off. It should be switched only between normal-work mode and Deep-sleep mode.

- In normal-work mode, RTC\_DBIAS[2:0] can be used to tune the output voltage:

$$VDD\_RTC = 0.90 + DBIAS \cdot 0.05V$$

- In Deep-sleep mode, the output voltage of the regulator is fixed at about 0.75V.
- The current to the RTC core comes from pin VDD3P3\_RTC.

Figure 31-3 shows the structure of a low-power voltage regulator.

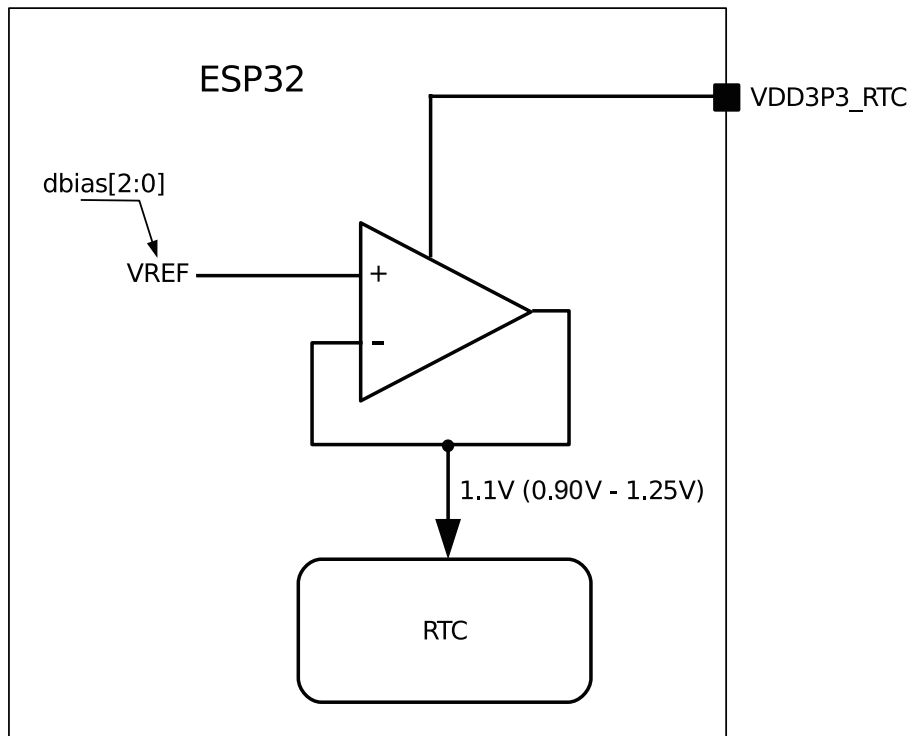


Figure 31-3. Low-Power Voltage Regulator

### 31.3.4 Flash Voltage Regulator

The built-in flash voltage regulator can supply a voltage of 3.3V or 1.8V to other devices (flash, for example) in the system, with a maximum output current of 40 mA.

- When `XPD_SDIO_VREG == 1`, the regulator outputs a voltage of 3.3V or 1.8V; when `XPD_SDIO_VREG == 0`, the output is high-impedance and, in this case, the voltage is provided by the external power supply.
- When `SDIO_TIEH == 1`, the regulator shorts pin VDD\_SDIO to pin VDD3P3\_RTC. The regulator then outputs a voltage of 3.3V which is the voltage of pin VDD3P3\_RTC. When `SDIO_TIEH == 0`, the inner loop ties the regulator output to the voltage of VREF, which is typically 1.8V.
- DREFH\_SDIO, DREFM\_SDIO and DREFL\_SDIO could be used to tune the reference voltage VREF slightly. However, it is recommended that users do not change the value of these registers, since it may affect the stability of the inner loop.
- When the regulator output is 3.3V or 1.8V, the output current comes from the pin VDD3P3\_RTC.

Figure 31-4 shows the structure of a flash voltage regulator.

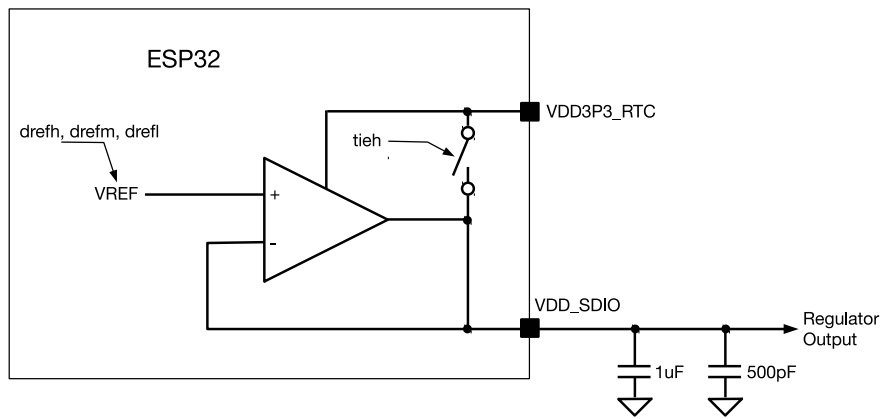


Figure 31-4. Flash Voltage Regulator

### 31.3.5 Brownout Detector

The brownout detector checks the voltage of pin VDD3P3\_RTC. If the voltage drops rapidly and becomes too low, the detector would trigger a signal to shut down some power-consuming blocks (such as LNA, PA, etc.) to allow extra time for the digital block to save and transfer important data. The power consumption of the detector is ultra low. It remains enabled whenever the chip is powered on, with an adjustable trigger level calibrated around 2.5V.

1. As the output of the brownout detector, `RTC_CNTL_BROWN_OUT_DET` goes high when the voltage of pin VDD3P3\_RTC is lower than the threshold value.
2. `RTC_CNTL_DBROWN_OUT_THRES[2:0]` is used to tune the threshold voltage, which is usually calibrated around 2.5V.

Figure 31-5 shows the structure of a brownout detector.

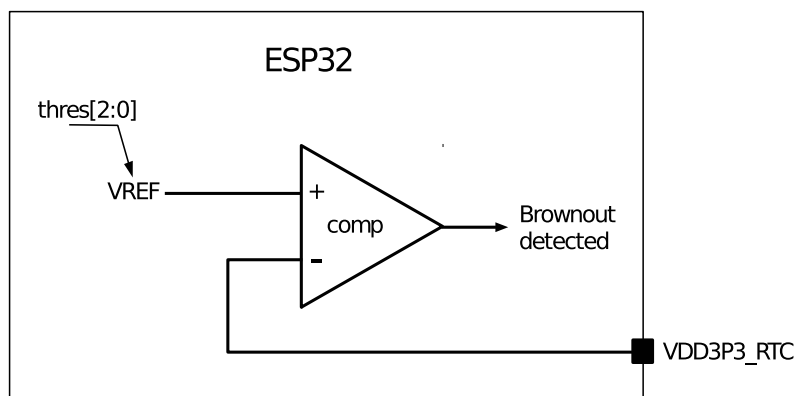


Figure 31-5. Brownout Detector

### 31.3.6 RTC Module

The RTC module is designed to handle the entry into, and exit from, the low-power mode, and control the clock sources, PLL, power switch and isolation cells to generate power-gating, clock-gating, and reset signals. As for the low-power management, RTC is composed of the following modules (see Figure 31-6):

- RTC main state machine: records the power state.

- Digital & analog power controller: generates actual power-gating/clock-gating signals for digital parts and analog parts.
- Sleep & wakeup controller: handles the entry into & exit from the low-power mode.
- Timers: include RTC main timer, ULP coprocessor timer and touch timer.
- Low-Power processor and sensor controllers: include ULP coprocessor, touch controller, SAR ADC controller, etc.
- Retention memory:
  - RTC slow memory: an 8 KB SRAM, mostly used as retention memory or instruction & data memory for the ULP coprocessor. The CPU accesses it through the APB, starting from address 0x50000000.
  - RTC fast memory: an 8 KB SRAM, mostly used as retention memory. The CPU accesses it through IRAM0/DRAM0. Fast RTC memory is about 10 times faster than the RTC slow memory.
- Retention registers: always-on registers of 8 x 32 bits, serving as data storage.
- RTC IO pads: 18 always-on analog pads, usually functioning as wake-up sources.

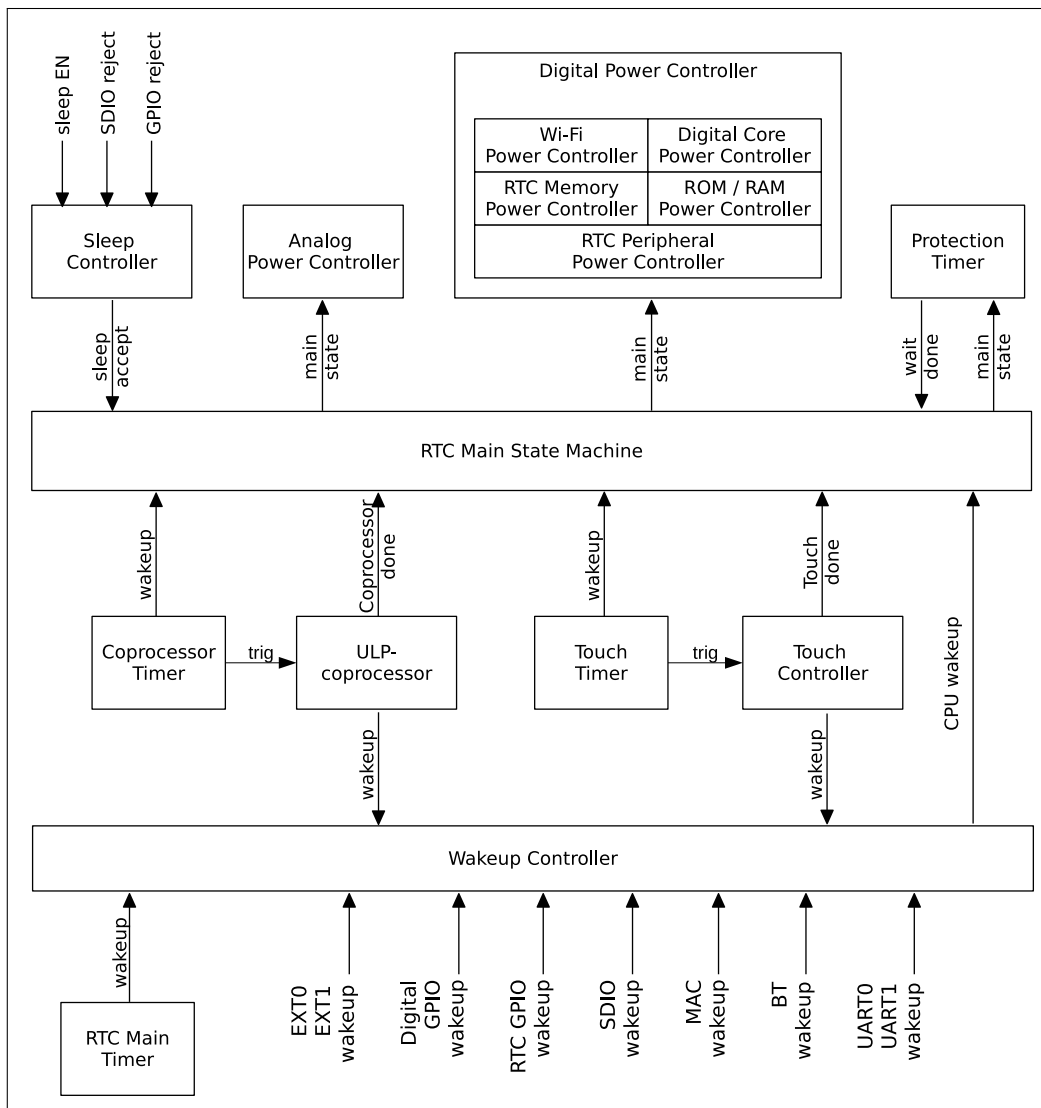


Figure 31-6. RTC Structure

### 31.3.7 Low-Power Clocks

In the low-power mode, the 40 MHz crystal and PLL are usually powered down to save power. But clocks are needed for the chip to remain active in the low-power mode.

For the RTC core, there are five possible clock sources:

- external low-speed (32.768 kHz) crystal clock CK\_XTAL\_32K,
- external high-speed (2 MHz ~ 40 MHz) crystal clock CK\_40M\_DIG,
- internal RC oscillator SLOW\_CK (typically about 150 kHz and adjustable),
- internal 8-MHz oscillator CK8M\_OUT, and
- internal 31.25-kHz clock CK8M\_D256\_OUT (derived from the internal 8-MHz oscillator divided by 256).

With these clocks, `fast_rtc_clk` and `slow_rtc_clk` is derived. By default, `fast_rtc_clk` is CK8M\_OUT while `slow_rtc_clk` is SLOW\_CK. For details, please see Figure 31-7.

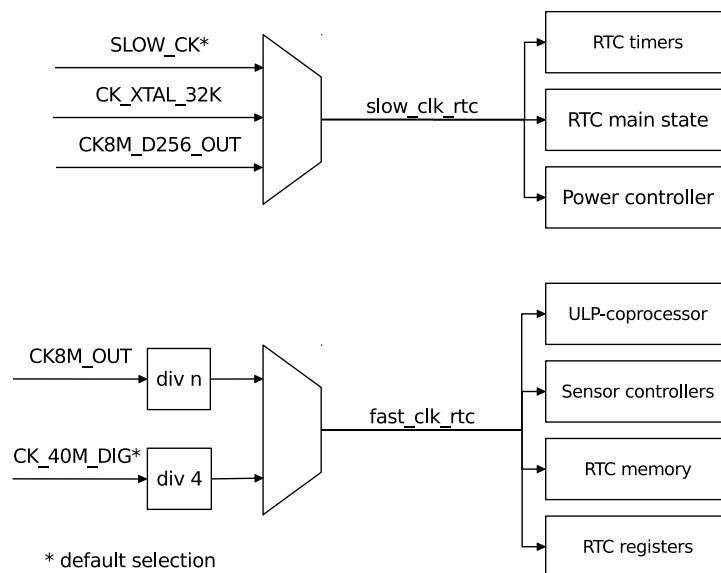


Figure 31-7. RTC Low-Power Clocks

For the digital core, `low_power_clk` is switched among four sources. For details, please see Figure 31-8.

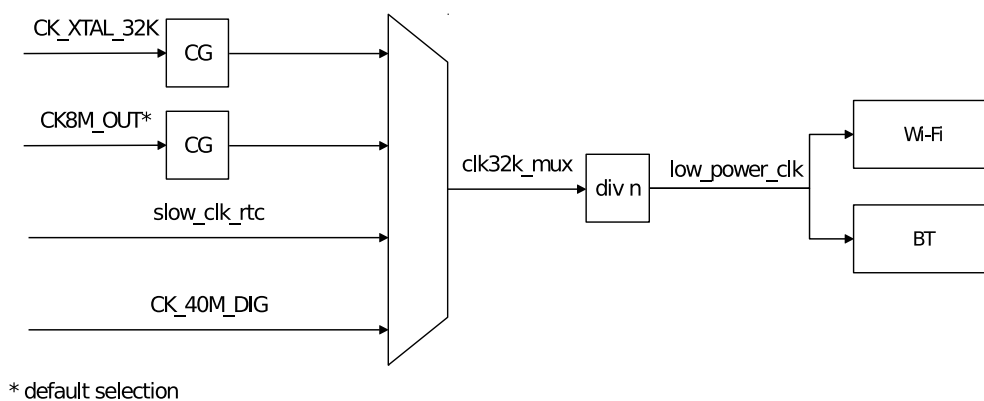
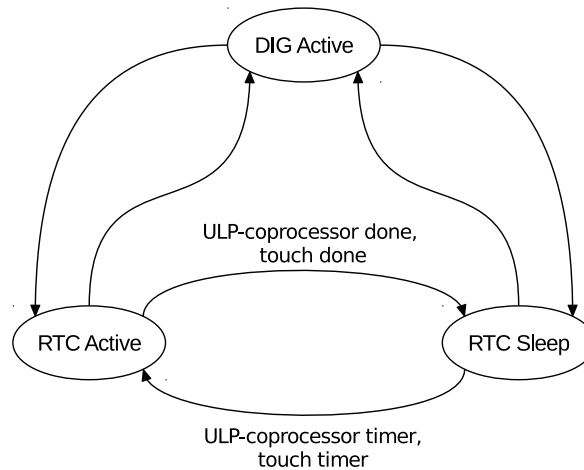


Figure 31-8. Digital Low-Power Clocks

### 31.3.8 Power-Gating Implementation



**Figure 31-9. RTC States**

The switch among power-gating states can be seen in Figure 31-9. The actual power-control signals could also be set by software as force-power-up (FPU) or force-power-down (FPD). Since the power domains can be power-gated independently, there are many combinations for different applications. Table 31-1 shows how the power domains in ESP32 are controlled.

**Table 31-1. RTC Power Domains**

Power Domains		RTC Main State			S/W Options		Notes*
		DIG Active	RTC Active	RTC Sleep	FPU	FPD	
RTC	RTC Digital Core	ON	ON	ON	N	N	1
	RTC Peripherals	ON	ON	OFF	Y	Y	2
	RTC Slow Memory	ON	OFF	OFF	Y	Y	3
	RTC Fast Memory	ON	OFF	OFF	Y	Y	4
Digital	Digital Core	ON	OFF	OFF	Y	Y	5
	Wi-Fi	ON	OFF	OFF	Y	Y	6
	ROM	ON	OFF	OFF	Y	Y	-
	Internal SRAM	ON	OFF	OFF	Y	Y	7
Analog	40 MHz Crystal	ON	OFF	OFF	Y	Y	-
	PLL	ON	OFF	OFF	Y	Y	-
	8 MHz OSC	ON	OFF	OFF	Y	Y	-
	Radio	-	-	-	Y	Y	-

Notes\*:

1. The power-domain RTC core is the “always-on” power domain, and the FPU/FPD option is not available.
2. The power-domain RTC peripherals include most of the fast logic in RTC, including the ULP co-processor, sensor controllers, etc.
3. The power-domain RTC slow memory should be forced to power on when it is used as retention memory, or when the ULP co-processor is working.
4. The power-domain RTC fast memory should be forced to power on, when it is used as retention memory.
5. When the power-domain digital core is powered down, all included in power domains are powered down.
6. The power-domain Wi-Fi includes the Wi-Fi MAC and BB.
7. Each internal SRAM can be power-gated independently.

### 31.3.9 Predefined Power Modes

In ESP32, we recommend that you always use the predefined power modes first, before trying to tune each power control signal. The predefined power modes should cover most scenarios:

- Active mode
  - The CPU is clocked at XTAL\_DIV\_N (40 MHz/26 MHz) or PLL (80 MHz/160 MHz/240 MHz).
  - The chip can receive, transmit, or listen.
- Modem-sleep mode
  - The CPU is operational and the clock is configurable.
  - The Wi-Fi/Bluetooth baseband is clock-gated or powered down. The radio is turned off.
  - Current consumption: ~30 mA with 80 MHz PLL.
  - Current consumption: ~3 mA with 2 MHz XTAL.
  - Immediate wake-up.
- Light-sleep mode
  - The internal 8 MHz oscillator, 40 MHz high-speed crystal, PLL, and radio are disabled.
  - The clock in the digital core is gated. The CPUs are stalled.
  - The ULP coprocessor and touch controller can be periodically triggered by monitor sensors.
  - Current consumption: ~ 800  $\mu$ A.
  - Wake-up latency: less than 1 ms.
- Deep-sleep mode
  - The internal 8 MHz oscillator, 40 MHz high-speed crystal, PLL and radio are disabled.
  - The digital core is powered down. The CPU context is lost.
  - The supply voltage to the RTC core drops to 0.7V.
  - 8 x 32 bits of data are kept in general-purpose retention registers.
  - The RTC memory and fast RTC memory can be retained.
  - Current consumption: ~ 6.5  $\mu$ A.
  - Wake-up latency: less than 1 ms.
  - Recommended for ultra-low-power infrequently-connected Wi-Fi/Bluetooth applications.
- Hibernation mode
  - The internal 8 MHz oscillator, 40 MHz high-speed crystal, PLL, and radio are disabled.
  - The digital core is powered down. The CPU context is lost.
  - The RTC peripheral domain is powered down.
  - The supply voltage to the RTC core drops to 0.7V.



- 8 x 32 bits of data are kept in general-purpose retention registers.
- The RTC memory and fast RTC memory are powered down.
- Current consumption: ~ 4.5  $\mu$ A.
- Wake-up source: RTC timer only.
- Wake-up latency: less than 1 ms.
- Recommended for ultra-low-power infrequently-connected Wi-Fi/Bluetooth applications.

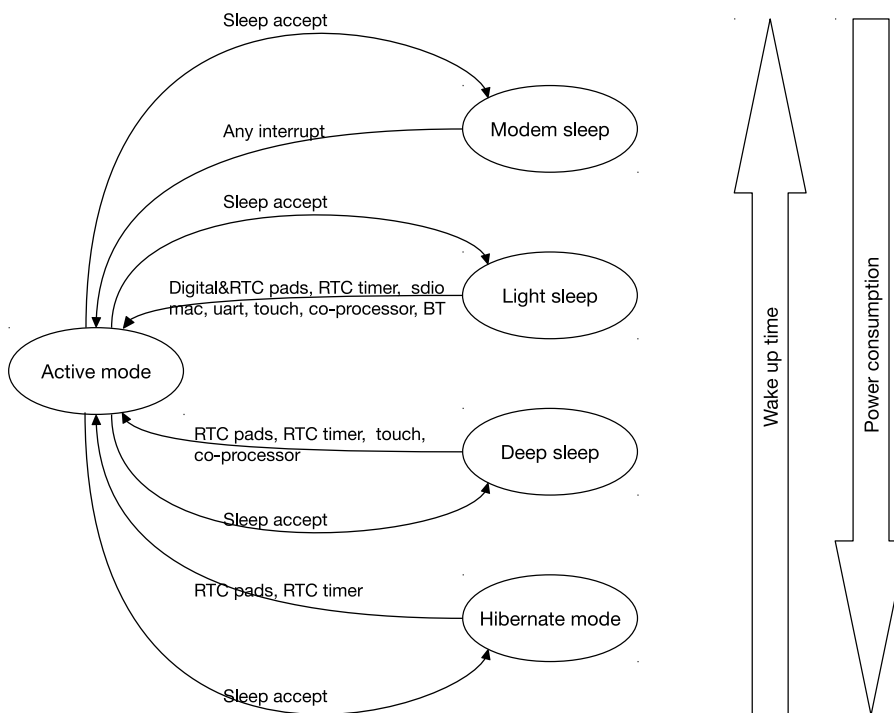


Figure 31-10. Power Modes

By default, the ESP32 is in active mode after a system reset. There are several low-power modes for saving power when the CPU does not need to be kept running, for example, when waiting for an external event. It is up to the user to select the mode that best balances power consumption, wake-up latency and available wake-up sources. For details, please see Figure 31-10.

Please note that the predefined power mode could be further optimized and adapted to any application.

### 31.3.10 Wakeup Source

The ESP32 supports various wake-up sources, which could wake up the CPU in different sleep modes. The wake-up source is determined by `RTC_CNTL_WAKEUP_ENA`, as shown in Table 31-2.

Table 31-2. Wake-up Source

WAKEUP_ENA	Wake-up Source	Light-sleep	Deep-sleep	Hibernation	Notes*
0x1	EXT0	Y	Y	-	1
0x2	EXT1	Y	Y	Y	2
0x4	GPIO	Y	Y	-	3
0x8	RTC timer	Y	Y	Y	-
0x10	SDIO	Y	-	-	4

WAKEUP_ENA	Wake-up Source	Light-sleep	Deep-sleep	Hibernation	Notes*
0x20	Wi-Fi	Y	-	-	5
0x40	UART0	Y	-	-	6
0x80	UART1	Y	-	-	6
0x100	TOUCH	Y	Y	-	-
0x200	ULP co-processor	Y	Y	-	-
0x400	BT	Y	-	-	5

Notes\*:

1. EXT0 can only wake up the chip in light-sleep/deep-sleep mode. If [RTC\\_CNTL\\_EXT\\_WAKEUP0\\_LV](#) is 1, it is pad high-level triggered; otherwise, it is low-level triggered. Users can set [RTCIO\\_EXT\\_WAKEUP0\\_SEL\[4:0\]](#) to select one of the RTC PADS to be the wake-up source.

2. EXT1 is especially designed to wake up the chip from any sleep mode, and it also supports multiple pads' combinations. First, [RTC\\_CNTL\\_EXT\\_WAKEUP1\\_SEL\[17:0\]](#) should be configured with the bitmap of PADS selected as a wake-up source. Then, if [RTC\\_CNTL\\_EXT\\_WAKEUP1\\_LV](#) is 1, as long as one of the PADS is at high-voltage level, it can trigger a wake-up. However, if [RTC\\_CNTL\\_EXT\\_WAKEUP1\\_LV](#) is 0, it needs all selected PADS to be at low-voltage level to trigger a wake-up.

3. In Deep-sleep mode, only RTC GPIOs (not DIGITAL GPIOs) can work as wakeup source.

4. Wake-up is triggered by receiving any SDIO command.

5. To wake up the chip with a Wi-Fi or BT source, the power mode switches between the Active, Modem- and Light-sleep modes. The CPU, Wi-Fi, Bluetooth, and radio are woken up at predetermined intervals to keep Wi-Fi/BT connections active.

6. Wake-up is triggered when the number of positive edges of RxD signal is greater than or equal to [\(UART\\_ACTIVE\\_THRESHOLD\)](#)

**Note** that the RxD signal cannot be input through GPIO Matrix but only through IO\_MUX.

### 31.3.11 RTC Timer

The RTC timer is a 48-bit counter that can be read. The clock is [RTC\\_SLOW\\_CLK](#). Any reset/sleep mode, except for the power-up reset, will not stop or reset the RTC timer.

The RTC timer can be used to wake up the CPU at a designated time, and to wake up TOUCH or the ULP coprocessor periodically.

### 31.3.12 RTC Boot

Since the CPU, ROM and RAM are powered down during Deep-sleep and Hibernation mode, the wake-up time is much longer than that in Light sleep/Modem sleep, because of the ROM unpacking and data-copying from the flash (SPI booting). There are two types of SRAM in the RTC, named slow RTC memory and fast RTC memory, which remain powered-on in Deep-sleep mode. For small-scale codes (less than 8 KB), there are two methods of speeding up the wake-up time, i.e. avoiding ROM unpacking and SPI booting.

The first method is to use the RTC slow memory:

1. Set register [RTC\\_CNTL\\_PROCPU\\_STAT\\_VECTOR\\_SEL](#) for PRO\_CPU (or register [RTC\\_CNTL\\_APPCPU\\_STAT\\_VECTOR\\_SEL](#) for APP\_CPU) to 0.
2. Put the chip into sleep.
3. When the CPU is powered up, the reset vector starts from 0x50000000, instead of 0x40000400. ROM unpacking & SPI boot are not needed. The code in RTC memory has to do itself some initialization for the C

program environment.

The second method is to use the fast RTC memory:

1. Set register `RTC_CNTL_PROCPU_STAT_VECTOR_SEL` for PRO\_CPU (or register `RTC_CNTL_APPCPU_STAT_VECTOR_SEL` for APP\_CPU) to 1.
2. Calculate CRC for the fast RTC memory, and save the result in register `RTC_CNTL_RTC_STORE6_REG[31:0]`.
3. Input register `RTC_CNTL_RTC_STORE7_REG[31:0]` with the entry address in the fast RTC memory.
4. Put the chip into sleep.
5. When the CPU is powered up, after ROM unpacking and some necessary initialization, the CRC is calculated again. If the result matches with register `RTC_CNTL_RTC_STORE6_REG[31:0]`, the CPU will jump to the entry address.

The boot flow is shown in Figure 31-11.

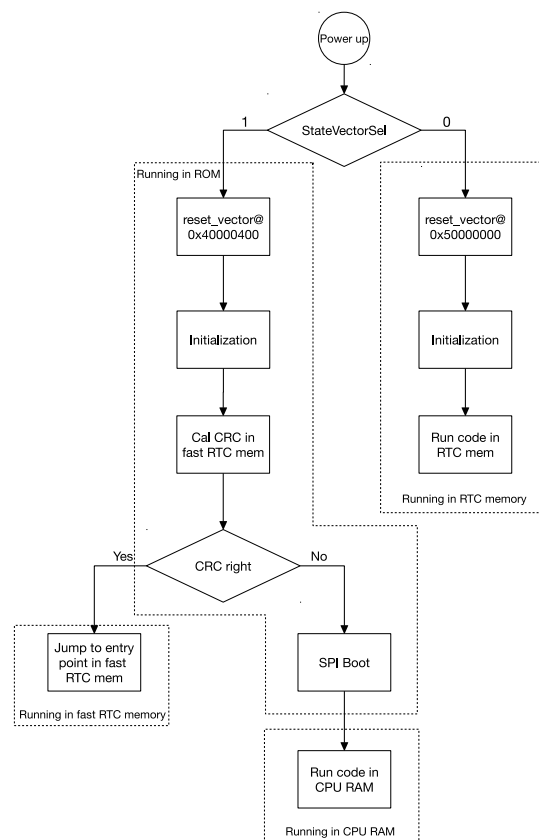


Figure 31-11. ESP32 Boot Flow

## 31.4 Register Summary

Notes:

- The registers listed below have been grouped according to their functionality. This particular grouping does not reflect the exact sequential order in which they are stored in memory.
- The base address for registers is 0x60008000 when accessed by AHB, and 0x3FF48000 when accessed by DPORT bus.

Name	Description	Address	Access
<b>RTC option register</b>			
RTC_CNTL_OPTIONS0_REG	Configure RTC options	0x3FF48000	R/W
<b>Control and configuration of RTC timer registers</b>			
RTC_CNTL_SLP_TIMER0_REG	RTC sleep timer	0x3FF48004	R/W
RTC_CNTL_SLP_TIMER1_REG	RTC sleep timer, alarm and control	0x3FF48008	R/W
RTC_CNTL_TIME_UPDATE_REG	Update control of RTC timer	0x3FF4800C	RO
RTC_CNTL_TIME0_REG	RTC timer low 32 bits	0x3FF48010	RO
RTC_CNTL_TIME1_REG	RTC timer high 16 bits	0x3FF48014	RO
RTC_CNTL_STATE0_REG	RTC sleep, SDIO and ULP control	0x3FF48018	R/W
RTC_CNTL_TIMER1_REG	CPU stall enable	0x3FF4801C	R/W
RTC_CNTL_TIMER2_REG	Slow clock and touch controller configuration	0x3FF48020	R/W
RTC_CNTL_TIMER5_REG	Minimal sleep cycles in slow clock	0x3FF4802C	R/W
<b>Reset state and wakeup control registers</b>			
RTC_CNTL_RESET_STATE_REG	Reset state control and cause of CPUs	0x3FF48034	RO
RTC_CNTL_WAKEUP_STATE_REG	Wake-up filter, enable and cause	0x3FF48038	RO
RTC_CNTL_EXT_WAKEUP_CONF_REG	Configuration of wake-up at low/high level	0x3FF48060	R/W
RTC_CNTL_EXT_WAKEUP1_REG	Selection of pads for external wake-up and wake-up clear bit	0x3FF480CC	R/W
RTC_CNTL_EXT_WAKEUP1_STATUS_REG	External wake-up status	0x3FF480D0	RO
<b>RTC interrupt control and status registers</b>			
RTC_CNTL_INT_ENA_REG	Interrupt enable bits	0x3FF4803C	R/W
RTC_CNTL_INT_RAW_REG	Raw interrupt status	0x3FF48040	RO
RTC_CNTL_INT_ST_REG	Masked interrupt status	0x3FF48044	RO
RTC_CNTL_INT_CLR_REG	Interrupt clear bits	0x3FF48048	WO
<b>RTC general purpose retention registers</b>			
RTC_CNTL_STORE0_REG	General purpose retention register 0	0x3FF4804C	R/W
RTC_CNTL_STORE1_REG	General purpose retention register 1	0x3FF48050	R/W
RTC_CNTL_STORE2_REG	General purpose retention register 2	0x3FF48054	R/W
RTC_CNTL_STORE3_REG	General purpose retention register 3	0x3FF48058	R/W
RTC_CNTL_STORE4_REG	General purpose retention register 4	0x3FF480B0	R/W
RTC_CNTL_STORE5_REG	General purpose retention register 5	0x3FF480B4	R/W
RTC_CNTL_STORE6_REG	General purpose retention register 6	0x3FF480B8	R/W
RTC_CNTL_STORE7_REG	General purpose retention register 7	0x3FF480BC	R/W
<b>Internal power management registers</b>			
RTC_CNTL_ANA_CONF_REG	Power-up/down configuration	0x3FF48030	R/W
RTC_CNTL_VREG_REG	Internal power distribution and control	0x3FF4807C	R/W
RTC_CNTL_PWC_REG	RTC domain power management	0x3FF48080	R/W
RTC_CNTL_DIG_PWC_REG	Digital domain power management	0x3FF48084	R/W
RTC_CNTL_DIG_ISO_REG	Digital domain isolation control	0x3FF48088	RO
<b>RTC watchdog configuration and control registers</b>			
RTC_CNTL_WDTCONFIG0_REG	WDT Configuration register 0	0x3FF4808C	R/W

Name	Description	Address	Access
<a href="#">RTC_CNTL_WDTCONFIG1_REG</a>	WDT Configuration register 1	0x3FF48090	R/W
<a href="#">RTC_CNTL_WDTCONFIG2_REG</a>	WDT Configuration register 2	0x3FF48094	R/W
<a href="#">RTC_CNTL_WDTCONFIG3_REG</a>	WDT Configuration register 3	0x3FF48098	R/W
<a href="#">RTC_CNTL_WDTCONFIG4_REG</a>	WDT Configuration register 4	0x3FF4809C	R/W
<a href="#">RTC_CNTL_WDTFEED_REG</a>	Watchdog feed register	0x3FF480A0	WO
<a href="#">RTC_CNTL_WDTWPROTECT_REG</a>	Watchdog write protect register	0x3FF480A4	R/W
<b>Miscellaneous RTC configuration registers</b>			
<a href="#">RTC_CNTL_EXT_XTL_CONF_REG</a>	XTAL control by external pads	0x3FF4805C	R/W
<a href="#">RTC_CNTL_SLP_REJECT_CONF_REG</a>	Reject cause and enable control	0x3FF48064	R/W
<a href="#">RTC_CNTL_CPU_PERIOD_CONF_REG</a>	CPU period select	0x3FF48068	R/W
<a href="#">RTC_CNTL_CLK_CONF_REG</a>	Configuration of RTC clocks	0x3FF48070	R/W
<a href="#">RTC_CNTL_SDIO_CONF_REG</a>	SDIO configuration	0x3FF48074	R/W
<a href="#">RTC_CNTL_SW_CPU_STALL_REG</a>	Stall of CPUs	0x3FF480AC	R/W
<a href="#">RTC_CNTL_HOLD_FORCE_REG</a>	RTC pad hold register	0x3FF480C8	R/W
<a href="#">RTC_CNTL_BROWN_OUT_REG</a>	Brownout management	0x3FF480D4	R/W

## 31.5 Registers

Register 31.1. RTC\_CNTL\_OPTIONS0\_REG (0x3FF48000)

31	30	29	28	27	26	25	24	23	22	21	20	19	18	17	16	15	14	13	12	11	10	9	8	7	6	5	4	3	2	1	0					
0	0	0	0	0	0	0	0	0	1	0	0	1	0	0	1	0	0	1	0	0	0	0	0	0	0	0	0	0	0	0	0	0	0	0	0	0

Reset

**RTC\_CNTL\_SW\_SYS\_RST** SW system reset. (WO)

**RTC\_CNTL\_DG\_WRAP\_FORCE\_NORST** The digital core forces no reset in deep sleep. (R/W)

**RTC\_CNTL\_DG\_WRAP\_FORCE\_RST** The digital core can force a reset in deep sleep. (R/W)

**RTC\_CNTL\_BIAS\_CORE\_FORCE\_PU** BIAS\_CORE force power up. (R/W)

**RTC\_CNTL\_BIAS\_CORE\_FORCE\_PD** BIAS\_CORE force power down. (R/W)

**RTC\_CNTL\_BIAS\_CORE\_FOLW\_8M** BIAS\_CORE follow CK8M. (R/W)

**RTC\_CNTL\_BIAS\_I2C\_FORCE\_PU** BIAS\_I2C force power up. (R/W)

**RTC\_CNTL\_BIAS\_I2C\_FORCE\_PD** BIAS\_I2C force power down. (R/W)

**RTC\_CNTL\_BIAS\_I2C\_FOLW\_8M** BIAS\_I2C follow CK8M. (R/W)

**RTC\_CNTL\_BIAS\_FORCE\_NOSLEEP** BIAS\_SLEEP force no sleep. (R/W)

**RTC\_CNTL\_BIAS\_FORCE\_SLEEP** BIAS\_SLEEP force sleep. (R/W)

**RTC\_CNTL\_BIAS\_SLEEP\_FOLW\_8M** BIAS\_SLEEP follow CK8M. (R/W)

**RTC\_CNTL\_XTL\_FORCE\_PU** Crystal force power up. (R/W)

**RTC\_CNTL\_XTL\_FORCE\_PD** Crystal force power down. (R/W)

**RTC\_CNTL\_BBPLL\_FORCE\_PU** BB\_PLL force power up. (R/W)

**RTC\_CNTL\_BBPLL\_FORCE\_PD** BB\_PLL force power down. (R/W)

**RTC\_CNTL\_BBPLL\_I2C\_FORCE\_PU** BB\_PLL\_I2C force power up. (R/W)

**RTC\_CNTL\_BBPLL\_I2C\_FORCE\_PD** BB\_PLL\_I2C force power down. (R/W)

**RTC\_CNTL\_BB\_I2C\_FORCE\_PU** BB\_I2C force power up. (R/W)

**RTC\_CNTL\_BB\_I2C\_FORCE\_PD** BB\_I2C force power down. (R/W)

Continued on the next page...

**Register 31.1. RTC\_CNTL\_OPTIONS0\_REG (0x3FF48000)**

Continued from the previous page...

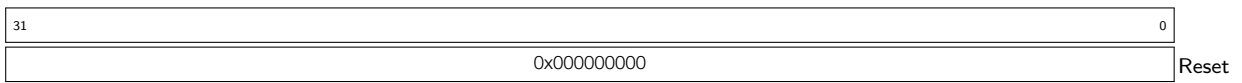
**RTC\_CNTL\_SW\_PROCPU\_RST** PRO\_CPU SW reset. (WO)

**RTC\_CNTL\_SW\_APPCPU\_RST** APP\_CPU SW reset. (WO)

**RTC\_CNTL\_SW\_STALL\_PROCPU\_C0** described under [RTC\\_CNTL\\_SW\\_CPU\\_STALL\\_REG](#). (R/W)

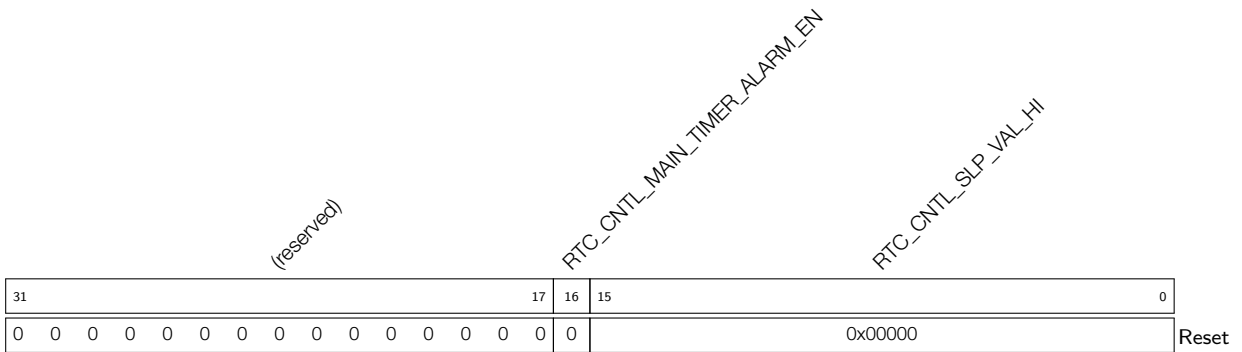
**RTC\_CNTL\_SW\_STALL\_APPCPU\_C0** described under [RTC\\_CNTL\\_SW\\_CPU\\_STALL\\_REG](#). (R/W)

**Register 31.2. RTC\_CNTL\_SLP\_TIMER0\_REG (0x3FF48004)**



**RTC\_CNTL\_SLP\_TIMER0\_REG** RTC sleep timer low 32 bits. (R/W)

**Register 31.3. RTC\_CNTL\_SLP\_TIMER1\_REG (0x3FF48008)**



**RTC\_CNTL\_MAIN\_TIMER\_ALARM\_EN** Timer alarm enable bit. (R/W)

**RTC\_CNTL\_SLP\_VAL\_HI** RTC sleep timer high 16 bits. (R/W)







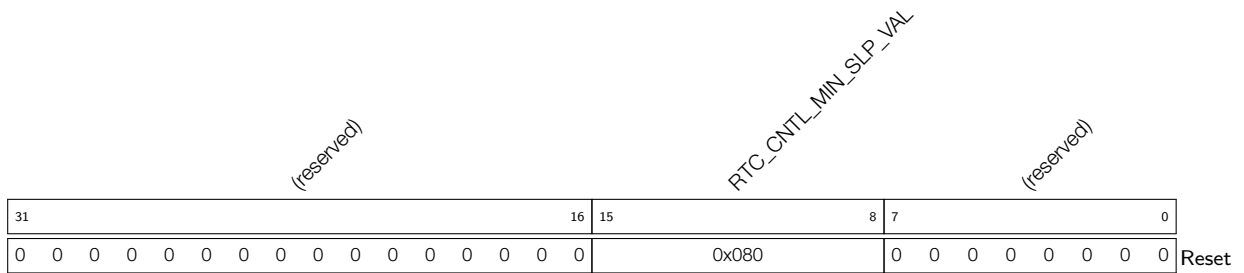
**Register 31.9. RTC\_CNTL\_TIMER2\_REG (0x3FF48020)**



**RTC\_CNTL\_MIN\_TIME\_CK8M\_OFF** Minimal amount of cycles in slow\_clk\_rtc to power down CK8M. (R/W)

**RTC\_CNTL\_ULPCP\_TOUCH\_START\_WAIT** Awaited cycles in slow\_clk\_rtc before ULP coprocessor/touch controller starts working. (R/W)

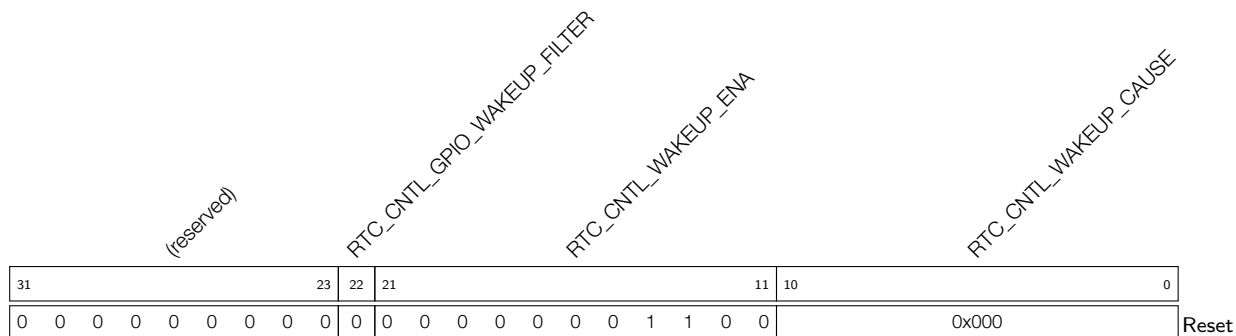
**Register 31.10. RTC\_CNTL\_TIMER5\_REG (0x3FF4802C)**



**RTC\_CNTL\_MIN\_SLP\_VAL** Minimal amount of sleep cycles in slow\_clk\_rtc. (R/W)



**Register 31.13. RTC\_CNTL\_WAKEUP\_STATE\_REG (0x3FF48038)**

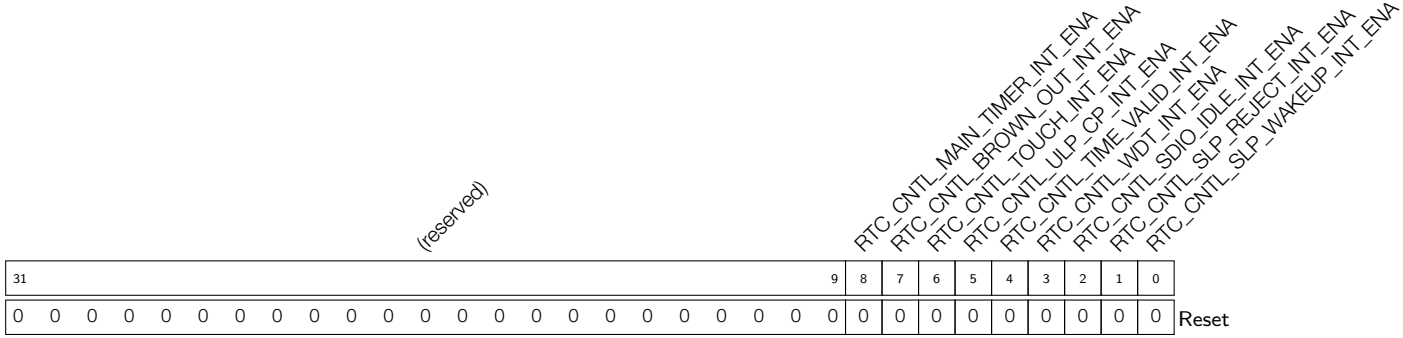


**RTC\_CNTL\_GPIO\_WAKEUP\_FILTER** Enable filter for GPIO wake-up event. (R/W)

**RTC\_CNTL\_WAKEUP\_ENA** Wake-up enable bitmap. (R/W)

**RTC\_CNTL\_WAKEUP\_CAUSE** Wake-up cause. (RO)

Register 31.14. RTC\_CNTL\_INT\_ENA\_REG (0x3FF4803C)



**RTC\_CNTL\_MAIN\_TIMER\_INT\_ENA** The interrupt enable bit for the RTC\_CNTL\_MAIN\_TIMER\_INT interrupt. (R/W)

**RTC\_CNTL\_BROWN\_OUT\_INT\_ENA** The interrupt enable bit for the RTC\_CNTL\_BROWN\_OUT\_INT interrupt. (R/W)

**RTC\_CNTL\_TOUCH\_INT\_ENA** The interrupt enable bit for the RTC\_CNTL\_TOUCH\_INT interrupt. (R/W)

**RTC\_CNTL\_ULP\_CP\_INT\_ENA** The interrupt enable bit for the RTC\_CNTL\_ULP\_CP\_INT interrupt. (R/W)

**RTC\_CNTL\_TIME\_VALID\_INT\_ENA** The interrupt enable bit for the RTC\_CNTL\_TIME\_VALID\_INT interrupt. (R/W)

**RTC\_CNTL\_WDT\_INT\_ENA** The interrupt enable bit for the RTC\_CNTL\_WDT\_INT interrupt. (R/W)

**RTC\_CNTL\_SDIO\_IDLE\_INT\_ENA** The interrupt enable bit for the RTC\_CNTL\_SDIO\_IDLE\_INT interrupt. (R/W)

**RTC\_CNTL\_SLP\_REJECT\_INT\_ENA** The interrupt enable bit for the RTC\_CNTL\_SLP\_REJECT\_INT interrupt. (R/W)

**RTC\_CNTL\_SLP\_WAKEUP\_INT\_ENA** The interrupt enable bit for the RTC\_CNTL\_SLP\_WAKEUP\_INT interrupt. (R/W)

## Register 31.15. RTC\_CNTL\_INT\_RAW\_REG (0x3FF48040)

(reserved)										RTC_CNTL_MAIN_TIMER_INT_RAW RTC_CNTL_BROWN_OUT_INT_RAW RTC_CNTL_TOUCH_INT_RAW RTC_CNTL_ULP_CP_INT_RAW RTC_CNTL_TIME_VALID_INT_RAW RTC_CNTL_WDT_INT_RAW RTC_CNTL_SDIO_IDLE_INT_RAW RTC_CNTL_SLP_REJECT_INT_RAW RTC_CNTL_SLP_WAKEUP_INT_RAW									
31									9	8	7	6	5	4	3	2	1	0	Reset
0 0 0 0 0 0 0 0 0 0 0 0 0 0 0 0 0 0																			

**RTC\_CNTL\_MAIN\_TIMER\_INT\_RAW** The raw interrupt status bit for the RTC\_CNTL\_MAIN\_TIMER\_INT interrupt. (RO)

**RTC\_CNTL\_BROWN\_OUT\_INT\_RAW** The raw interrupt status bit for the RTC\_CNTL\_BROWN\_OUT\_INT interrupt. (RO)

**RTC\_CNTL\_TOUCH\_INT\_RAW** The raw interrupt status bit for the RTC\_CNTL\_TOUCH\_INT interrupt. (RO)

**RTC\_CNTL\_ULP\_CP\_INT\_RAW** The raw interrupt status bit for the RTC\_CNTL\_ULP\_CP\_INT interrupt. (RO)

**RTC\_CNTL\_TIME\_VALID\_INT\_RAW** The raw interrupt status bit for the RTC\_CNTL\_TIME\_VALID\_INT interrupt. (RO)

**RTC\_CNTL\_WDT\_INT\_RAW** The raw interrupt status bit for the RTC\_CNTL\_WDT\_INT interrupt. (RO)

**RTC\_CNTL\_SDIO\_IDLE\_INT\_RAW** The raw interrupt status bit for the RTC\_CNTL\_SDIO\_IDLE\_INT interrupt. (RO)

**RTC\_CNTL\_SLP\_REJECT\_INT\_RAW** The raw interrupt status bit for the RTC\_CNTL\_SLP\_REJECT\_INT interrupt. (RO)

**RTC\_CNTL\_SLP\_WAKEUP\_INT\_RAW** The raw interrupt status bit for the RTC\_CNTL\_SLP\_WAKEUP\_INT interrupt. (RO)

## Register 31.16. RTC\_CNTL\_INT\_ST\_REG (0x3FF48044)

(reserved)										RTC_CNTL_MAIN_TIMER_INT_ST RTC_CNTL_BROWN_OUT_INT_ST RTC_CNTL_TOUCH_INT_ST RTC_CNTL_SAR_INT_ST RTC_CNTL_TIME_VALID_INT_ST RTC_CNTL_WDT_INT_ST RTC_CNTL_SDIO_IDLE_INT_ST RTC_CNTL_SLP_REJECT_INT_ST RTC_CNTL_SLP_WAKEUP_INT_ST																												
31																			9	8	7	6	5	4	3	2	1	0	Reset									
0																			0	0	0	0	0	0	0	0	0	0	0	0	0	0	0	0	0	0	0	0

**RTC\_CNTL\_MAIN\_TIMER\_INT\_ST** The masked interrupt status bit for the RTC\_CNTL\_MAIN\_TIMER\_INT interrupt. (RO)

**RTC\_CNTL\_BROWN\_OUT\_INT\_ST** The masked interrupt status bit for the RTC\_CNTL\_BROWN\_OUT\_INT interrupt. (RO)

**RTC\_CNTL\_TOUCH\_INT\_ST** The masked interrupt status bit for the RTC\_CNTL\_TOUCH\_INT interrupt. (RO)

**RTC\_CNTL\_SAR\_INT\_ST** The masked interrupt status bit for the RTC\_CNTL\_SAR\_INT interrupt. (RO)

**RTC\_CNTL\_TIME\_VALID\_INT\_ST** The masked interrupt status bit for the RTC\_CNTL\_TIME\_VALID\_INT interrupt. (RO)

**RTC\_CNTL\_WDT\_INT\_ST** The masked interrupt status bit for the RTC\_CNTL\_WDT\_INT interrupt. (RO)

**RTC\_CNTL\_SDIO\_IDLE\_INT\_ST** The masked interrupt status bit for the RTC\_CNTL\_SDIO\_IDLE\_INT interrupt. (RO)

**RTC\_CNTL\_SLP\_REJECT\_INT\_ST** The masked interrupt status bit for the RTC\_CNTL\_SLP\_REJECT\_INT interrupt. (RO)

**RTC\_CNTL\_SLP\_WAKEUP\_INT\_ST** The masked interrupt status bit for the RTC\_CNTL\_SLP\_WAKEUP\_INT interrupt. (RO)

## Register 31.17. RTC\_CNTL\_INT\_CLR\_REG (0x3FF48048)

(reserved)																RTC_CNTL_MAIN_TIMER_INT_CLR RTC_CNTL_BROWN_OUT_INT_CLR RTC_CNTL_TOUCH_INT_CLR RTC_CNTL_SAR_INT_CLR RTC_CNTL_TIME_VALID_INT_CLR RTC_CNTL_WDT_INT_CLR RTC_CNTL_SDIO_IDLE_INT_CLR RTC_CNTL_SLP_REJECT_INT_CLR RTC_CNTL_SLP_WAKEUP_INT_CLR										
31																9	8	7	6	5	4	3	2	1	0	
0																0								Reset		

**RTC\_CNTL\_MAIN\_TIMER\_INT\_CLR** Set this bit to clear the RTC\_CNTL\_MAIN\_TIMER\_INT interrupt. (WO)

**RTC\_CNTL\_BROWN\_OUT\_INT\_CLR** Set this bit to clear the RTC\_CNTL\_BROWN\_OUT\_INT interrupt. (WO)

**RTC\_CNTL\_TOUCH\_INT\_CLR** Set this bit to clear the RTC\_CNTL\_TOUCH\_INT interrupt. (WO)

**RTC\_CNTL\_SAR\_INT\_CLR** Set this bit to clear the RTC\_CNTL\_SAR\_INT interrupt. (WO)

**RTC\_CNTL\_TIME\_VALID\_INT\_CLR** Set this bit to clear the RTC\_CNTL\_TIME\_VALID\_INT interrupt. (WO)

**RTC\_CNTL\_WDT\_INT\_CLR** Set this bit to clear the RTC\_CNTL\_WDT\_INT interrupt. (WO)

**RTC\_CNTL\_SDIO\_IDLE\_INT\_CLR** Set this bit to clear the RTC\_CNTL\_SDIO\_IDLE\_INT interrupt. (WO)

**RTC\_CNTL\_SLP\_REJECT\_INT\_CLR** Set this bit to clear the RTC\_CNTL\_SLP\_REJECT\_INT interrupt. (WO)

**RTC\_CNTL\_SLP\_WAKEUP\_INT\_CLR** Set this bit to clear the RTC\_CNTL\_SLP\_WAKEUP\_INT interrupt. (WO)

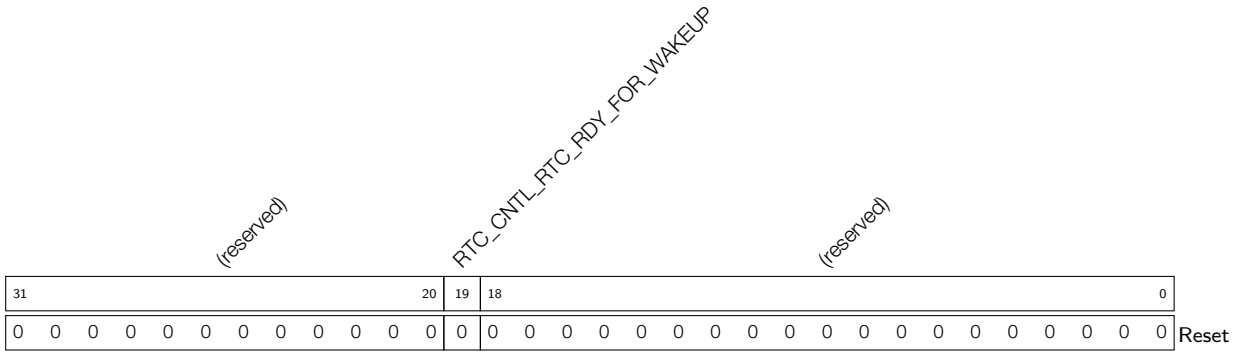
Register 31.18. RTC\_CNTL\_STORE<sub>n</sub>\_REG (*n*: 0-3) (0x3FF4804C+4\**n*)

31																															0	
x																																Reset

**RTC\_CNTL\_STORE<sub>n</sub>\_REG** 32-bit general-purpose retention register. (R/W)

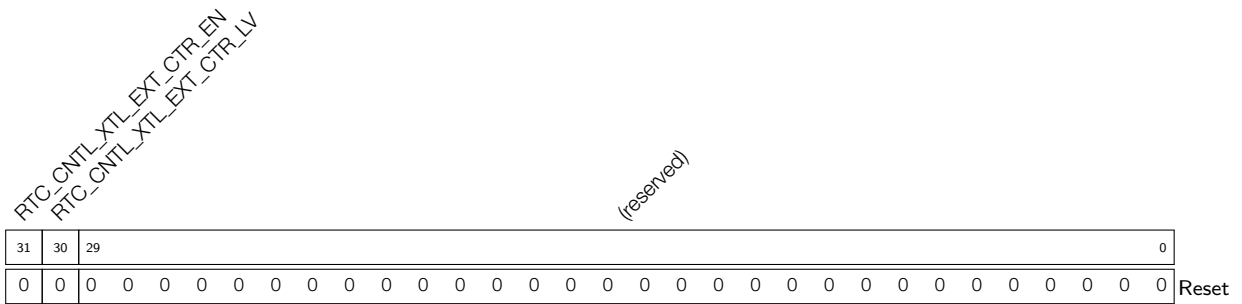


**Register 31.19. RTC\_CNTL\_LOW\_POWER\_ST\_REG (0x3FF480C0)**



**RTC\_CNTL\_RTC\_RDY\_FOR\_WAKEUP** Indicates the RTC is ready to be triggered by any wakeup source. (RO)

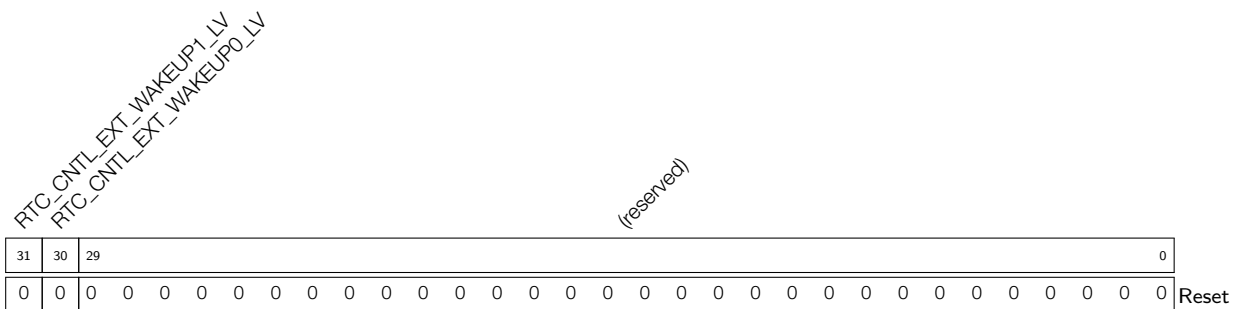
**Register 31.20. RTC\_CNTL\_EXT\_XTL\_CONF\_REG (0x3FF4805C)**



**RTC\_CNTL\_XTL\_EXT\_CTRL\_EN** Enable control XTAL with external pads. (R/W)

**RTC\_CNTL\_XTL\_EXT\_CTRL\_LV** 0: power down XTAL at high level, 1: power down XTAL at low level. (R/W)

**Register 31.21. RTC\_CNTL\_EXT\_WAKEUP\_CONF\_REG (0x3FF48060)**



**RTC\_CNTL\_EXT\_WAKEUP1\_LV** 0: external wake-up at low level, 1: external wake-up at high level. (R/W)

**RTC\_CNTL\_EXT\_WAKEUP0\_LV** 0: external wake-up at low level, 1: external wake-up at high level. (R/W)

**Register 31.22. RTC\_CNTL\_SLP\_REJECT\_CONF\_REG (0x3FF48064)**

		RTC_CNTL_REJECT_CAUSE				RTC_CNTL_DEEP_SLP_REJECT_EN				RTC_CNTL_LIGHT_SLP_REJECT_EN				RTC_CNTL_SDIO_REJECT_EN				RTC_CNTL_GPIO_REJECT_EN				(reserved)
31	28	27	26	25	24	23																
0	0	0	0	0	0	0	0	0	0	0	0	0	0	0	0	0	0	0	0	0	0	

Reset

**RTC\_CNTL\_REJECT\_CAUSE** Sleep reject cause. (RO)

**RTC\_CNTL\_DEEP\_SLP\_REJECT\_EN** Enable reject for deep sleep. (R/W)

**RTC\_CNTL\_LIGHT\_SLP\_REJECT\_EN** Enable reject for light sleep. (R/W)

**RTC\_CNTL\_SDIO\_REJECT\_EN** Enable SDIO reject. (R/W)

**RTC\_CNTL\_GPIO\_REJECT\_EN** Enable GPIO reject. (R/W)

**Register 31.23. RTC\_CNTL\_CPU\_PERIOD\_CONF\_REG (0x3FF48068)**

		RTC_CNTL_RTC_CPUPERIOD_SEL		RTC_CNTL_CPUSEL_CONF				(reserved)
31	30	29	28					
0	0	0	0	0	0	0	0	0

Reset

**RTC\_CNTL\_RTC\_CPUPERIOD\_SEL** CPU period selection. (R/W)

**RTC\_CNTL\_CPUSEL\_CONF** CPU selection option. (R/W)

## Register 31.24. RTC\_CNTL\_CLK\_CONF\_REG (0x3FF48070)

RTC_CNTL_ANA_CLK_RTC_SEL				RTC_CNTL_FAST_CLK_RTC_SEL				RTC_CNTL_SOC_CLK_SEL				RTC_CNTL_CK8M_FORCE_PU				RTC_CNTL_CK8M_FORCE_PD				RTC_CNTL_CK8M_DFREQ				(reserved)				RTC_CNTL_CK8M_DIV_SEL				(reserved)				RTC_CNTL_DIG_CLK8M_EN				RTC_CNTL_DIG_CLK8M_D256_EN				RTC_CNTL_DIG_XTAL32K_EN				RTC_CNTL_ENB_CK8M_DIV				RTC_CNTL_ENB_CK8M				(reserved)			
31	30	29	28	27	26	25	24							17	16	15	14					12	11	10	9	8	7	6	5	4	3					0																							
0	0	0	0	0	0			0						0	0			2				0	0	1	0	0	0	0	0	1	0	0	0	0	0																								

Reset

**RTC\_CNTL\_ANA\_CLK\_RTC\_SEL** slow\_clk\_rtc sel. 0: SLOW\_CK, 1: CK\_XTAL\_32K, 2: CK8M\_D256\_OUT. (R/W)

**RTC\_CNTL\_FAST\_CLK\_RTC\_SEL** fast\_clk\_rtc sel. 0: XTAL div 4, 1: CK8M. (R/W)

**RTC\_CNTL\_SOC\_CLK\_SEL** SoC clock selection. 0: XTAL, 1: PLL, 2: CK8M, 3: APLL. (R/W)

**RTC\_CNTL\_CK8M\_FORCE\_PU** CK8M force power up. (R/W)

**RTC\_CNTL\_CK8M\_FORCE\_PD** CK8M force power down. (R/W)

**RTC\_CNTL\_CK8M\_DFREQ** CK8M\_DFREQ. (R/W)

**RTC\_CNTL\_CK8M\_DIV\_SEL** Divider = reg\_rtc\_cntl\_ck8m\_div\_sel + 1. (R/W)

**RTC\_CNTL\_DIG\_CLK8M\_EN** Enable CK8M for digital core (no relation to RTC core). (R/W)

**RTC\_CNTL\_DIG\_CLK8M\_D256\_EN** Enable CK8M\_D256\_OUT for digital core (no relation to RTC core). (R/W)

**RTC\_CNTL\_DIG\_XTAL32K\_EN** Enable CK\_XTAL\_32K for digital core (no relation to RTC core). (R/W)

**RTC\_CNTL\_ENB\_CK8M\_DIV** 1: CK8M\_D256\_OUT is actually CK8M, 0: CK8M\_D256\_OUT is CK8M divided by 256. (R/W)

**RTC\_CNTL\_ENB\_CK8M** Disable CK8M and CK8M\_D256\_OUT. (R/W)

**RTC\_CNTL\_CK8M\_DIV** CK8M\_D256\_OUT divider. 00: div128, 01: div256, 10: div512, 11: div1024. (R/W)

## Register 31.25. RTC\_CNTL\_SDIO\_CONF\_REG (0x3FF48074)

												(reserved)																																			
31	30	29	28	27	26	25	24	23	22	21	20													0																							
0	0	0	0	0	0	1	0	1	0	1	0	0	0	0	0	0	0	0	0	0	0	0	0	0	0	0	0	0	0	0	0	0	0	0	0	0	0	0	0	0	0	0	0	0	0	0	Reset

**RTC\_CNTL\_XPD\_SDIO\_VREG** SW option for XPD\_SDIO\_VREG; active only when `reg_rtc_cntl_sdio_force == 1`. (R/W)

**RTC\_CNTL\_DREFH\_SDIO** SW option for DREFH\_SDIO; active only when `reg_rtc_cntl_sdio_force == 1`. (R/W)

**RTC\_CNTL\_DREFM\_SDIO** SW option for DREFM\_SDIO; active only when `reg_rtc_cntl_sdio_force == 1`. (R/W)

**RTC\_CNTL\_DREFL\_SDIO** SW option for DREFL\_SDIO; active only when `reg_rtc_cntl_sdio_force == 1`. (R/W)

**RTC\_CNTL\_REG1P8\_READY** Read-only register for REG1P8\_READY. (RO)

**RTC\_CNTL\_SDIO\_TIEH** SW option for SDIO\_TIEH; active only when `reg_rtc_cntl_sdio_force == 1`. (R/W)

**RTC\_CNTL\_SDIO\_FORCE** 1: use SW option to control SDIO\_VREG; 0: use state machine to control SDIO\_VREG. (R/W)

**RTC\_CNTL\_SDIO\_VREG\_PD\_EN** Power down SDIO\_VREG in sleep; active only when `reg_rtc_cntl_sdio_force == 0`. (R/W)

## Register 31.26. RTC\_CNTL\_VREG\_REG (0x3FF4807C)

RTC_CNTL_PREG_FORCE_PU		RTC_CNTL_PREG_FORCE_PD		RTC_CNTL_DBOOST_FORCE_PU		RTC_CNTL_DBOOST_FORCE_PD		RTC_CNTL_DBIAS_WAK		RTC_CNTL_DBIAS_SLP		RTC_CNTL_SCK_DCAP		RTC_CNTL_DIG_VREG_DBIAS_WAK		RTC_CNTL_DIG_VREG_DBIAS_SLP		(reserved)	
31	30	29	28	27	25	24	22	21	14	13	11	10	8	7					
1	0	1	0	4		4		0		4		4		0 0 0 0 0 0 0 0					

Reset

**RTC\_CNTL\_VREG\_FORCE\_PU** RTC voltage regulator - force power up. (R/W)

**RTC\_CNTL\_VREG\_FORCE\_PD** RTC voltage regulator - force power down (in this case power down means decreasing the voltage to 0.8V or lower). (R/W)

**RTC\_CNTL\_DBOOST\_FORCE\_PU** RTC\_DBOOST force power up. (R/W)

**RTC\_CNTL\_DBOOST\_FORCE\_PD** RTC\_DBOOST force power down. (R/W)

**RTC\_CNTL\_DBIAS\_WAK** RTC\_DBIAS during wake-up. (R/W)

**RTC\_CNTL\_DBIAS\_SLP** RTC\_DBIAS during sleep. (R/W)

**RTC\_CNTL\_SCK\_DCAP** Used to adjust the frequency of RTC slow clock. (R/W)

**RTC\_CNTL\_DIG\_VREG\_DBIAS\_WAK** Digital voltage regulator DBIAS during wake-up. (R/W)

**RTC\_CNTL\_DIG\_VREG\_DBIAS\_SLP** Digital voltage regulator DBIAS during sleep. (R/W)

Register 31.27. RTC\_CNTL\_PWC\_REG (0x3FF48080)

(reserved)												RTC_CNTL_PD_EN RTC_CNTL_FORCE_PU RTC_CNTL_FORCE_PD RTC_CNTL_SLOWMEM_PD_EN RTC_CNTL_SLOWMEM_FORCE_PU RTC_CNTL_SLOWMEM_FORCE_PD RTC_CNTL_FASTMEM_PD_EN RTC_CNTL_FASTMEM_FORCE_PU RTC_CNTL_FASTMEM_FORCE_PD RTC_CNTL_SLOWMEM_FORCE_LPU RTC_CNTL_SLOWMEM_FORCE_LPD RTC_CNTL_SLOWMEM_FOLW_CPU RTC_CNTL_FASTMEM_FORCE_LPU RTC_CNTL_FASTMEM_FORCE_LPD RTC_CNTL_FORCE_NOISO RTC_CNTL_FORCE_ISO RTC_CNTL_SLOWMEM_FORCE_ISO RTC_CNTL_SLOWMEM_FORCE_NOISO RTC_CNTL_FASTMEM_FORCE_ISO RTC_CNTL_FASTMEM_FORCE_NOISO																						
31												21	20	19	18	17	16	15	14	13	12	11	10	9	8	7	6	5	4	3	2	1	0	
0	0	0	0	0	0	0	0	0	0	0	0	0	0	1	0	0	1	0	1	0	0	1	0	0	1	0	0	1	0	1	0	1	Reset	

- RTC\_CNTL\_PD\_EN** Enable power down rtc\_peri in sleep. (R/W)
- RTC\_CNTL\_FORCE\_PU** rtc\_peri force power up. (R/W)
- RTC\_CNTL\_FORCE\_PD** rtc\_peri force power down. (R/W)
- RTC\_CNTL\_SLOWMEM\_PD\_EN** Enable power down RTC memory in sleep. (R/W)
- RTC\_CNTL\_SLOWMEM\_FORCE\_PU** RTC memory force power up. (R/W)
- RTC\_CNTL\_SLOWMEM\_FORCE\_PD** RTC memory force power down. (R/W)
- RTC\_CNTL\_FASTMEM\_PD\_EN** Enable power down fast RTC memory in sleep. (R/W)
- RTC\_CNTL\_FASTMEM\_FORCE\_PU** Fast RTC memory force power up. (R/W)
- RTC\_CNTL\_FASTMEM\_FORCE\_PD** Fast RTC memory force power down. (R/W)
- RTC\_CNTL\_SLOWMEM\_FORCE\_LPU** RTC memory force power up in low-power mode. (R/W)
- RTC\_CNTL\_SLOWMEM\_FORCE\_LPD** RTC memory force power down in low-power mode. (R/W)
- RTC\_CNTL\_SLOWMEM\_FOLW\_CPU** 1: RTC memory low-power mode PD following CPU; 0: RTC memory low-power mode PD following RTC state machine. (R/W)
- RTC\_CNTL\_FASTMEM\_FORCE\_LPU** Fast RTC memory force power up in low-power mode. (R/W)
- RTC\_CNTL\_FASTMEM\_FORCE\_LPD** Fast RTC memory force power down in low-power mode. (R/W)
- RTC\_CNTL\_FASTMEM\_FOLW\_CPU** 1: Fast RTC memory low-power mode PD following CPU; 0: fast RTC memory low-power mode PD following RTC state machine. (R/W)
- RTC\_CNTL\_FORCE\_NOISO** rtc\_peri force no isolation. (R/W)
- RTC\_CNTL\_FORCE\_ISO** rtc\_peri force isolation. (R/W)
- RTC\_CNTL\_SLOWMEM\_FORCE\_ISO** RTC memory force isolation. (R/W)
- RTC\_CNTL\_SLOWMEM\_FORCE\_NOISO** RTC memory force no isolation. (R/W)
- RTC\_CNTL\_FASTMEM\_FORCE\_ISO** Fast RTC memory force isolation. (R/W)
- RTC\_CNTL\_FASTMEM\_FORCE\_NOISO** Fast RTC memory force no isolation. (R/W)

## Register 31.28. RTC\_CNTL\_DIG\_PWC\_REG (0x3FF48084)

31	30	29	28	27	26	25	24	23	21	20	19	18	17	16	15	14	13	12	11	10	9	8	7	6	5	4	3	2	0		
x	x	x	x	x	x	x	x	0	0	0	1	0	1	0	1	0	1	0	1	0	1	0	1	0	1	0	1	0	0	0	0

Reset

**RTC\_CNTL\_DG\_WRAP\_PD\_EN** Enable power down digital core in sleep mode. (R/W)

**RTC\_CNTL\_WIFI\_PD\_EN** Enable power down Wi-Fi in sleep. (R/W)

**RTC\_CNTL\_INTER\_RAM4\_PD\_EN** Enable power down internal SRAM 4 in sleep mode. (R/W)

**RTC\_CNTL\_INTER\_RAM3\_PD\_EN** Enable power down internal SRAM 3 in sleep mode. (R/W)

**RTC\_CNTL\_INTER\_RAM2\_PD\_EN** Enable power down internal SRAM 2 in sleep mode. (R/W)

**RTC\_CNTL\_INTER\_RAM1\_PD\_EN** Enable power down internal SRAM 1 in sleep mode. (R/W)

**RTC\_CNTL\_INTER\_RAM0\_PD\_EN** Enable power down internal SRAM 0 in sleep mode. (R/W)

**RTC\_CNTL\_ROM0\_PD\_EN** Enable power down ROM in sleep mode. (R/W)

**RTC\_CNTL\_DG\_WRAP\_FORCE\_PU** Digital core force power up. (R/W)

**RTC\_CNTL\_DG\_WRAP\_FORCE\_PD** Digital core force power down. (R/W)

**RTC\_CNTL\_WIFI\_FORCE\_PU** Wi-Fi force power up. (R/W)

**RTC\_CNTL\_WIFI\_FORCE\_PD** Wi-Fi force power down. (R/W)

**RTC\_CNTL\_INTER\_RAM4\_FORCE\_PU** Internal SRAM 4 force power up. (R/W)

**RTC\_CNTL\_INTER\_RAM4\_FORCE\_PD** Internal SRAM 4 force power down. (R/W)

**RTC\_CNTL\_INTER\_RAM3\_FORCE\_PU** Internal SRAM 3 force power up. (R/W)

**RTC\_CNTL\_INTER\_RAM3\_FORCE\_PD** Internal SRAM 3 force power down. (R/W)

**RTC\_CNTL\_INTER\_RAM2\_FORCE\_PU** Internal SRAM 2 force power up. (R/W)

**RTC\_CNTL\_INTER\_RAM2\_FORCE\_PD** Internal SRAM 2 force power down. (R/W)

**RTC\_CNTL\_INTER\_RAM1\_FORCE\_PU** Internal SRAM 1 force power up. (R/W)

**RTC\_CNTL\_INTER\_RAM1\_FORCE\_PD** Internal SRAM 1 force power down. (R/W)

**RTC\_CNTL\_INTER\_RAM0\_FORCE\_PU** Internal SRAM 0 force power up. (R/W)

**RTC\_CNTL\_INTER\_RAM0\_FORCE\_PD** Internal SRAM 0 force power down. (R/W)

**RTC\_CNTL\_ROM0\_FORCE\_PU** ROM force power up. (R/W)

Continued on the next page...

**Register 31.28. RTC\_CNTL\_DIG\_PWC\_REG (0x3FF48084)**

Continued from the previous page...

**RTC\_CNTL\_ROM0\_FORCE\_PD** ROM force power down. (R/W)

**RTC\_CNTL\_LSLP\_MEM\_FORCE\_PU** Memories in digital core force power up in sleep mode. (R/W)

**RTC\_CNTL\_LSLP\_MEM\_FORCE\_PD** Memories in digital core force power down in sleep mode.  
(R/W)





**Register 31.29. RTC\_CNTL\_DIG\_ISO\_REG (0x3FF48088)**

Continued from the previous page...

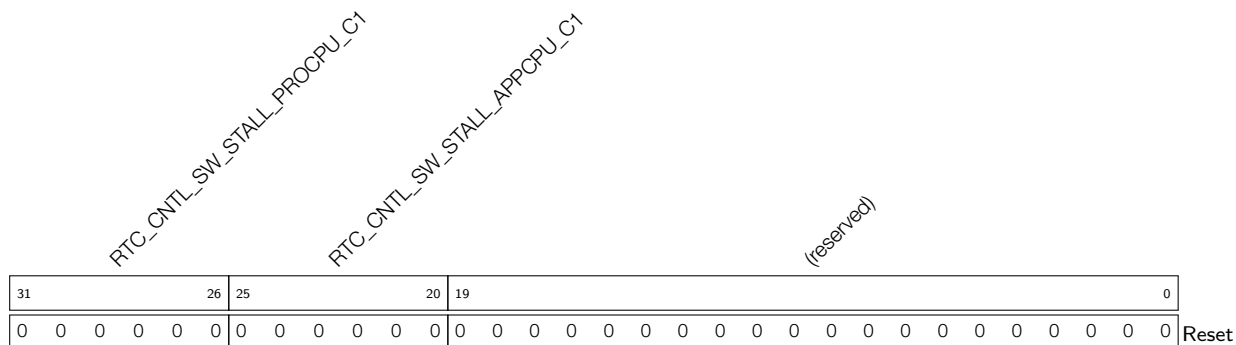
**RTC\_CNTL\_REG\_RTC\_CNTL\_DG\_PAD\_AUTOHOLD\_EN** Digital pad enable auto-hold. (R/W)**RTC\_CNTL\_CLR\_REG\_RTC\_CNTL\_DG\_PAD\_AUTOHOLD** Write-only register clears digital pad auto-hold. (WO)**RTC\_CNTL\_DG\_PAD\_AUTOHOLD** Read-only register indicates digital pad auto-hold status. (RO)**Register 31.30. RTC\_CNTL\_WDTCONFIG0\_REG (0x3FF4808C)**

<i>RTC_CNTL_WDT_EN</i>		<i>RTC_CNTL_WDT_STG0</i>		<i>RTC_CNTL_WDT_STG1</i>		<i>RTC_CNTL_WDT_STG2</i>		<i>RTC_CNTL_WDT_STG3</i>		<i>reserved</i>		<i>reserved</i>		<i>RTC_CNTL_WDT_CPU_RESET_LENGTH</i>		<i>RTC_CNTL_WDT_SYS_RESET_LENGTH</i>		<i>RTC_CNTL_WDT_FLASHBOOT_MOD_EN</i>		<i>RTC_CNTL_WDT_PROCPU_RESET_EN</i>		<i>RTC_CNTL_WDT_APPCPU_RESET_EN</i>		<i>RTC_CNTL_WDT_PAUSE_IN_SLP</i>		<i>reserved</i>	
31	30	28	27	25	24	22	21	19	18	17	16	14	13	11	10	9	8	7	6							0	
0	0	0	0	0	0	0	0	0	0	0	1	1	1	1	0	0	1							0			

**RTC\_CNTL\_WDT\_PAUSE\_IN\_SLP** Pause RTC WDT in sleep. (R/W)**RTC\_CNTL\_WDT\_APPCPU\_RESET\_EN** RTC WDT reset APP\_CPU enable. (R/W)**RTC\_CNTL\_WDT\_PROCPU\_RESET\_EN** RTC WDT reset PRO\_CPU enable. (R/W)**RTC\_CNTL\_WDT\_FLASHBOOT\_MOD\_EN** Enable RTC WDT in flash boot. (R/W)**RTC\_CNTL\_WDT\_SYS\_RESET\_LENGTH** System reset counter length, unit: RTC\_SLOW\_CLK cycle. The value can be 0 ~ 7. (R/W)**RTC\_CNTL\_WDT\_CPU\_RESET\_LENGTH** CPU reset counter length, unit: RTC\_SLOW\_CLK cycle. The value can be 0 ~ 7. (R/W)**RTC\_CNTL\_WDT\_STG3** 1: interrupt stage enable, 2: CPU reset stage enable, 3: system reset stage enable, 4: RTC reset stage enable. (R/W)**RTC\_CNTL\_WDT\_STG2** 1: interrupt stage enable, 2: CPU reset stage enable, 3: system reset stage enable, 4: RTC reset stage enable. (R/W)**RTC\_CNTL\_WDT\_STG1** 1: interrupt stage enable, 2: CPU reset stage enable, 3: system reset stage enable, 4: RTC reset stage enable. (R/W)**RTC\_CNTL\_WDT\_STG0** 1: interrupt stage enable, 2: CPU reset stage enable, 3: system reset stage enable, 4: RTC reset stage enable. (R/W)**RTC\_CNTL\_WDT\_EN** Enable RTC WDT. (R/W)

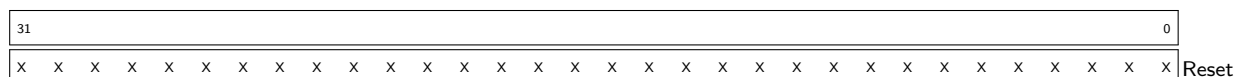


## Register 31.34. RTC\_CNTL\_SW\_CPU\_STALL\_REG (0x3FF480AC)



**RTC\_CNTL\_SW\_STALL\_PROCPU\_C1** reg\_rtc\_cntl\_sw\_stall\_procpu\_c1[5:0],  
 reg\_rtc\_cntl\_sw\_stall\_procpu\_c0[1:0] == 0x86 (100001 10) will stall PRO\_CPU, see also  
[RTC\\_CNTL\\_OPTIONS0\\_REG](#). (R/W)

**RTC\_CNTL\_SW\_STALL\_APPCPU\_C1** reg\_rtc\_cntl\_sw\_stall\_appcpu\_c1[5:0],  
 reg\_rtc\_cntl\_sw\_stall\_appcpu\_c0[1:0] == 0x86 (100001 10) will stall APP\_CPU, see also  
[RTC\\_CNTL\\_OPTIONS0\\_REG](#). (R/W)

Register 31.35. RTC\_CNTL\_STORE $n$ \_REG ( $n$ : 4-7) (0x3FF480B0+4\* $n$ )

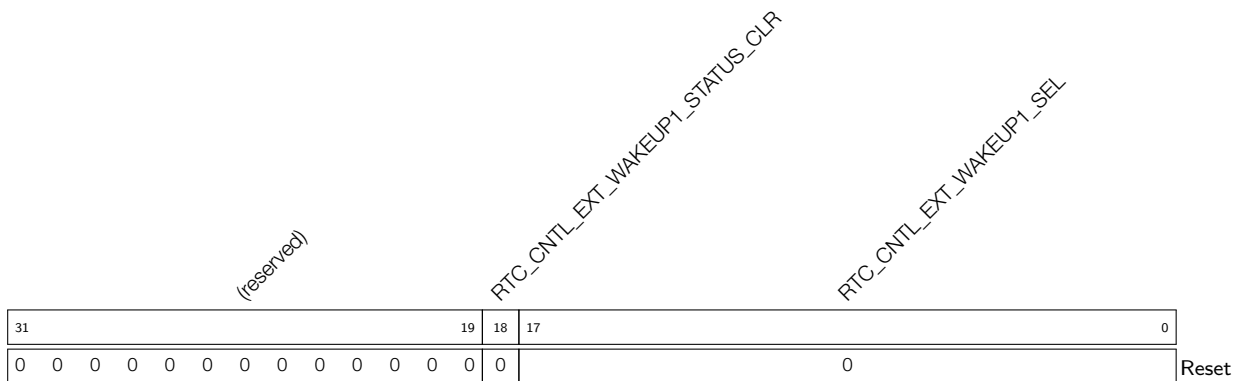
**RTC\_CNTL\_STORE $n$ \_REG** 32-bit general-purpose retention register. (R/W)

## Register 31.36. RTC\_CNTL\_HOLD\_FORCE\_REG (0x3FF480C8)

(reserved)																		RTC_CNTL_X32N_HOLD_FORCE RTC_CNTL_X32P_HOLD_FORCE RTC_CNTL_TOUCH_PAD7_HOLD_FORCE RTC_CNTL_TOUCH_PAD6_HOLD_FORCE RTC_CNTL_TOUCH_PAD5_HOLD_FORCE RTC_CNTL_TOUCH_PAD4_HOLD_FORCE RTC_CNTL_TOUCH_PAD3_HOLD_FORCE RTC_CNTL_TOUCH_PAD2_HOLD_FORCE RTC_CNTL_TOUCH_PAD1_HOLD_FORCE RTC_CNTL_SENSE4_HOLD_FORCE RTC_CNTL_SENSE3_HOLD_FORCE RTC_CNTL_SENSE2_HOLD_FORCE RTC_CNTL_PDAC2_HOLD_FORCE RTC_CNTL_PDAC1_HOLD_FORCE RTC_CNTL_ADC2_HOLD_FORCE RTC_CNTL_ADC1_HOLD_FORCE																			
31																		18	17	16	15	14	13	12	11	10	9	8	7	6	5	4	3	2	1	0	Reset
0 0																																					

- RTC\_CNTL\_X32N\_HOLD\_FORCE** Set to preserve pad's state during hibernation. (R/W)
- RTC\_CNTL\_X32P\_HOLD\_FORCE** Set to preserve pad's state during hibernation. (R/W)
- RTC\_CNTL\_TOUCH\_PAD7\_HOLD\_FORCE** Set to preserve pad's state during hibernation. (R/W)
- RTC\_CNTL\_TOUCH\_PAD6\_HOLD\_FORCE** Set to preserve pad's state during hibernation. (R/W)
- RTC\_CNTL\_TOUCH\_PAD5\_HOLD\_FORCE** Set to preserve pad's state during hibernation. (R/W)
- RTC\_CNTL\_TOUCH\_PAD4\_HOLD\_FORCE** Set to preserve pad's state during hibernation. (R/W)
- RTC\_CNTL\_TOUCH\_PAD3\_HOLD\_FORCE** Set to preserve pad's state during hibernation. (R/W)
- RTC\_CNTL\_TOUCH\_PAD2\_HOLD\_FORCE** Set to preserve pad's state during hibernation. (R/W)
- RTC\_CNTL\_TOUCH\_PAD1\_HOLD\_FORCE** Set to preserve pad's state during hibernation. (R/W)
- RTC\_CNTL\_TOUCH\_PAD0\_HOLD\_FORCE** Set to preserve pad's state during hibernation. (R/W)
- RTC\_CNTL\_SENSE4\_HOLD\_FORCE** Set to preserve pad's state during hibernation. (R/W)
- RTC\_CNTL\_SENSE3\_HOLD\_FORCE** Set to preserve pad's state during hibernation. (R/W)
- RTC\_CNTL\_SENSE2\_HOLD\_FORCE** Set to preserve pad's state during hibernation. (R/W)
- RTC\_CNTL\_SENSE1\_HOLD\_FORCE** Set to preserve pad's state during hibernation. (R/W)
- RTC\_CNTL\_PDAC2\_HOLD\_FORCE** Set to preserve pad's state during hibernation. (R/W)
- RTC\_CNTL\_PDAC1\_HOLD\_FORCE** Set to preserve pad's state during hibernation. (R/W)
- RTC\_CNTL\_ADC2\_HOLD\_FORCE** Set to preserve pad's state during hibernation. (R/W)
- RTC\_CNTL\_ADC1\_HOLD\_FORCE** Set to preserve pad's state during hibernation. (R/W)

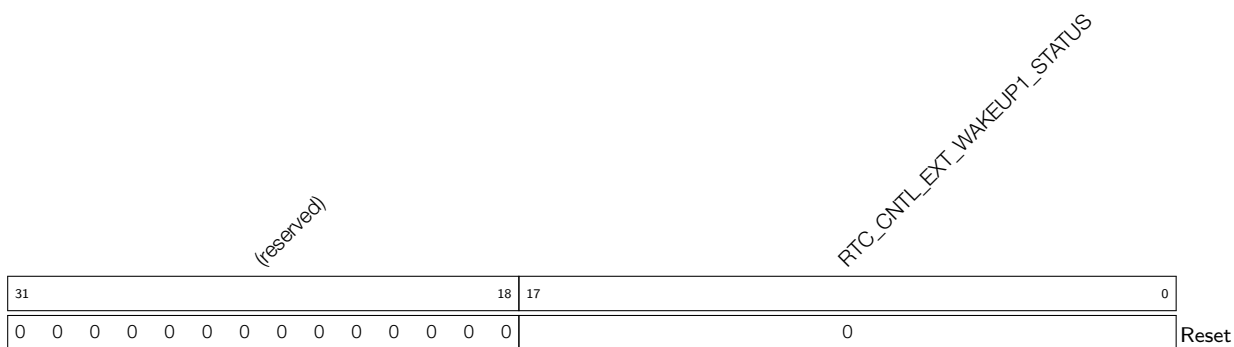
**Register 31.37. RTC\_CNTL\_EXT\_WAKEUP1\_REG (0x3FF480CC)**



**RTC\_CNTL\_EXT\_WAKEUP1\_STATUS\_CLR** Clear external wakeup1 status. (WO)

**RTC\_CNTL\_EXT\_WAKEUP1\_SEL** Bitmap to select RTC pads for external wakeup1. (R/W)

**Register 31.38. RTC\_CNTL\_EXT\_WAKEUP1\_STATUS\_REG (0x3FF480D0)**



**RTC\_CNTL\_EXT\_WAKEUP1\_STATUS** External wakeup1 status. (RO)

## Register 31.39. RTC\_CNTL\_BROWN\_OUT\_REG (0x3FF480D4)

RTC_CNTL_BROWN_OUT_DET		RTC_CNTL_BROWN_OUT_ENA		RTC_CNTL_DBROWN_OUT_THRES		RTC_CNTL_BROWN_OUT_RST_ENA		RTC_CNTL_BROWN_OUT_RST_WAIT		RTC_CNTL_BROWN_OUT_PD_RF_ENA		RTC_CNTL_BROWN_OUT_CLOSE_FLASH_ENA		(reserved)		
31	30	29	27	26	25	16	15	14	13							0
0	0	0x2	0	0x3FF		0	0	0	0	0	0	0	0	0	0	Reset

**RTC\_CNTL\_BROWN\_OUT\_DET** Brownout detect. (RO)

**RTC\_CNTL\_BROWN\_OUT\_ENA** Enables brownout. (R/W)

**RTC\_CNTL\_DBROWN\_OUT\_THRES** Brownout threshold. The brownout detector will reset the chip when the supply voltage is approximately below this level. Note that there may be some variation of brownout voltage level between each ESP32 chip. 0: 2.43 V  $\pm$  0.05; 1: 2.48 V  $\pm$  0.05; 2: 2.58 V  $\pm$  0.05; 3: 2.62 V  $\pm$  0.05; 4: 2.67 V  $\pm$  0.05; 5: 2.70 V  $\pm$  0.05; 6: 2.77 V  $\pm$  0.05; 7: 2.80 V  $\pm$  0.05. (R/W)

**RTC\_CNTL\_BROWN\_OUT\_RST\_ENA** Enables brownout reset. (R/W)

**RTC\_CNTL\_BROWN\_OUT\_RST\_WAIT** Brownout reset wait cycles. (R/W)

**RTC\_CNTL\_BROWN\_OUT\_PD\_RF\_ENA** Enables power down RF when brownout happens. (R/W)

**RTC\_CNTL\_BROWN\_OUT\_CLOSE\_FLASH\_ENA** Sends suspend command to flash when brownout happens. (R/W)

## Glossary

### Abbreviations for Peripherals

AES	AES Accelerator
AHB	Advanced High-performance Bus. For more information, please refer to its <a href="#">specification</a> .
APB	Advanced Peripheral Bus. For more information, please refer to its <a href="#">specification</a> .
DMA	DMA Controller
DPORT	Short for Data Port. The full name is Xtensa Local Memory Interface (XLMI) Port.
eFuse	eFuse Controller
EMAC	Ethernet MAC
I2C	I2C Controller
I2S	I2S Controller
LEDC	LED_PWM Controller
MCPWM	Motor Control PWM
MMU	Memory Management Unit
MPU	Memory Protection Unit
PCNT	Pulse Count Controller
PERI	Peripheral
PID	Process Identifier
PMU	Power Management Unit
RMT	Remote Control Peripheral
RNG	Random Number Generator
RSA	RSA Accelerator
RTC	Real Time Controller. A group of circuits in SoC that keeps working in any chip mode and at any time.
SDMMC	SD/MMC Host Controller
SHA	SHA Accelerator
SPI	SPI Controller
TIMG	Timer Group
UART	UART Controller
ULP Coprocessor	Ultra-low-power Coprocessor
WDT	Watchdog Timers

### Abbreviations for Registers

ISO	Isolation. When a module is power down, its output pins will be stuck in unknown state (some middle voltage). "ISO" registers will control to isolate its output pins to be a determined value, so it will not affect the status of other working modules which are not power down.
NMI	Non-maskable interrupt.
REG	Register.
R/W	Read/write. Software can read and write to these bits.
RO	Read-only. Software can only read these bits.
WO	Write-only. Software can only write to these bits.



## Revision History

Date	Version	Release notes
2022.08	v4.7	<ul style="list-style-type: none"> <li>• Updated Table 1-6 in Chapter 1 <i>System and Memory</i></li> <li>• Updated Chapter 4 <i>IO_MUX and GPIO Matrix (GPIO, IO_MUX)</i>: <ul style="list-style-type: none"> <li>– Updated the description in Section 4.2.2</li> <li>– Updated the description of GPIO_PIN<sub>n</sub>_INT_ENA and IO_MUX_PIN_CTRL</li> </ul> </li> <li>• Added a note about in_link descriptor in Section 6.4 in Chapter 6 <i>DMA Controller (DMA)</i></li> <li>• Updated clock names: <ul style="list-style-type: none"> <li>– RTC8M_CLK: renamed as RC_FAST_CLK</li> <li>– RTC8M_D256_CLK: renamed as RC_FAST_DIV_CLK</li> <li>– RTC_CLK: renamed as RC_SLOW_CLK</li> <li>– SLOW_CLK: renamed as RTC_SLOW_CLK</li> <li>– FAST_CLK: renamed as RTC_FAST_CLK</li> </ul> </li> <li>• Updated the description below Figure 17-2 in Chapter 17 <i>Pulse Count Controller (PCNT)</i></li> <li>• Updated Section 18.3 in Chapter 18 <i>Timer Group (TIMG)</i></li> <li>• Added two notes in Chapter 29 <i>On-Chip Sensors and Analog Signal Processing</i></li> </ul>
2021.11	v4.6	<p>Updated Table 1-6 in Chapter 1 <i>System and Memory</i></p> <p>Updated Table 2-1 in Chapter 2 <i>Interrupt Matrix (INTERRUPT)</i></p> <p>Updated Figure 3-1 in Chapter 3 <i>Reset and Clock</i></p> <p>Updated Table 4-2 and description of IO_MUX_PIN_CTRL in Chapter 4 <i>IO_MUX and GPIO Matrix (GPIO, IO_MUX)</i></p> <p>Major updates to Chapter 5 <i>DPort Registers</i></p> <p>Added a note below Table 12-1 in Chapter 12 <i>I2S Controller (I2S)</i></p> <p>Updated Section 8.3.6 and description of register SLCHOST_CONF_REG in Chapter 8 <i>SDIO Slave Controller</i></p> <p>Updated description in Chapter 26 <i>External Memory Encryption and Decryption (FLASH)</i></p> <p>Updated Section 29.5.3 in Chapter 29 <i>On-Chip Sensors and Analog Signal Processing</i></p> <p>Provided address clarification for Section Registers in Chapter 4, Chapter 7, Chapter 12, Chapter 15, Chapter 29, and Chapter 30</p> <p>Added new terms to Glossary</p> <p>Fixed typos</p>

**Cont'd on next page**

## Cont'd from previous page

Date	Version	Release notes
2021.07	v4.5	<p>Added Section <a href="#">10.6.4</a></p> <p>Added a note below Table <a href="#">4-4</a></p> <p>Added the base address information of interrupt matrix registers in Chapter <a href="#">5 DPort Registers</a> and in Chapter <a href="#">2 Interrupt Matrix (INTERRUPT)</a></p> <p>Updated the description in Section <a href="#">3.2.7</a></p> <p>Updated pin function numbers starting from Function0 in Chapter <a href="#">4 IO_MUX and GPIO Matrix (GPIO, IO_MUX)</a></p> <p>Updated Table <a href="#">14-1</a> in Chapter <a href="#">14 LED PWM Controller (LEDC)</a></p> <p>Updated base address for Ethernet MAC to 0x3FF6_9000 in section <a href="#">10.9</a></p> <p>Updated the description of UART_SW_RTS and UART_RX_FLOW_THRHD fields in Chapter <a href="#">13 UART Controller (UART)</a></p> <p>Updated the feature description in Chapter <a href="#">21 Two-wire Automotive Interface (TWAI)</a></p> <p>Updated description in Chapter <a href="#">25 Random Number Generator (RNG)</a></p> <p>Updated the description in Section <a href="#">30.4.2</a></p> <p>Fixed typos in Table <a href="#">2-1</a> and in Section <a href="#">6.4</a></p>
2021.03	V4.4	<p>Updated description to <a href="#">PWM_TIMER0_SYNC_REG ~ PWM_TIMER2_SYNC_REG</a> registers in Chapter <a href="#">16 Motor Control PWM (PWM)</a></p> <p>Updated the description of register <a href="#">TIMG<sub>n</sub>RTCCALICFG_REG</a> and register <a href="#">TIMG<sub>n</sub>RTCCALICFG1_REG</a> in Chapter <a href="#">18 Timer Group (TIMG)</a></p> <p>Updated the trademark symbol for Chapter <a href="#">21 Two-wire Automotive Interface (TWAI)</a></p> <p>Updated the description to <a href="#">RTC_CNTL_WDTCONFIG0_REG</a> in Chapter <a href="#">31: Low-Power Management (RTC_CNTL)</a></p> <p>Updated the description to <a href="#">EMACMIADDR_REG</a> in Chapter <a href="#">10: Ethernet Media Access Controller (MAC)</a></p> <p>Updated the access to <a href="#">UART_FIFO_REG</a> in Table <a href="#">13-1: UART Registers</a></p> <p>Updated the description to <a href="#">IO_MUX_x_REG (x: GPIO0-GPIO39)</a> and <a href="#">IO_MUX_x_REG (x: GPIO0-GPIO39)</a> in Chapter <a href="#">4: IO_MUX and GPIO Matrix (GPIO, IO_MUX)</a></p> <p>Updated the description of register <a href="#">RTC_CNTL_WDTCONFIG0_REG</a> in Chapter <a href="#">31 Low-Power Management (RTC_CNTL)</a></p> <p>Renamed Section: Documentation Conversions to Section: Glossary</p> <p>Updated the notes below Table <a href="#">4-3: IO_MUX Pad List</a></p>
2020.09	V4.3	<p>Added Chapter <a href="#">TWAI</a></p> <p>Added section <a href="#">25.4 Programming Procedure</a> and updated some description in Chapter <a href="#">25 Random Number Generator (RNG)</a></p> <p>Added information about <code>uart_download_dis</code> in Chapter <a href="#">eFuse Controller</a></p> <p>Updated the description of <a href="#">SPI_ADDR_REG</a> and <a href="#">SPI_SLV_WR_STATUS_REG</a></p>

Cont'd on next page

## Cont'd from previous page

Date	Version	Release notes
2020.06	V4.2	<p>Added Section: Documentation Conventions</p> <p>Changes to Chapter <a href="#">System and Memory</a>:</p> <ul style="list-style-type: none"> <li>Added a note about DPORT address and AHB address under Table 1-6</li> </ul> <p>Changes to Chapter <a href="#">Reset and Clock</a>:</p> <ul style="list-style-type: none"> <li>Updated Table 3-3 by adding PLL_CLK frequency of 480 MHz and CPU_CLK frequency of 240 MHz</li> <li>Updated Table 3-5 by modifying the APB_CLK frequency to 80 MHz when the CPU_CLK source is PLL_CLK</li> </ul> <p>Changes to Chapter <a href="#">IO_MUX and GPIO Matrix</a>:</p> <ul style="list-style-type: none"> <li>Fixed a typo in Section 4.4.2: For inputs, the SIG_IN_SEL register must be cleared to route the input directly to the peripheral.</li> <li>Changed the reset values for MTCK, MTMS, GPIO27 in Table 4-3</li> <li>Updated description of register <a href="#">FUN_DRV</a></li> </ul> <p>Changes to Chapter <a href="#">I<sup>2</sup>S</a>:</p> <ul style="list-style-type: none"> <li>Updated Section 12.4.1.1</li> </ul> <p>Changes to Chapter <a href="#">UART Controllers</a>:</p> <ul style="list-style-type: none"> <li>Updated the description of registers <a href="#">UART_FIFO_REG</a> and <a href="#">UART_RX_TOUT_THRHD</a></li> </ul> <p>Changes to Chapter <a href="#">LED_PWM</a>:</p> <ul style="list-style-type: none"> <li>Added Table 14-1</li> </ul> <p>Changes to Chapter <a href="#">MCPWM</a>:</p> <ul style="list-style-type: none"> <li>Corrected the PWM period in Count-Up, Count-Down, and Count-Up-Down modes</li> </ul> <p>Changes to Chapter <a href="#">PULSE_CNT</a>:</p> <ul style="list-style-type: none"> <li>Added description of register <a href="#">PCNT_Un_STATUS_REG</a></li> </ul> <p>Changes to Chapter <a href="#">eFuse Controller</a>:</p> <ul style="list-style-type: none"> <li>Combined system parameters "32pad" and "chip_version" into one: pkg_version</li> <li>Updated description of registers <a href="#">EFUSE_RD_CHIP_VER_PKG</a> and <a href="#">EFUSE_CHIP_VER_PKG</a></li> </ul> <p>Changes to Chapter <a href="#">Low-Power Management</a>:</p> <ul style="list-style-type: none"> <li>Added description of register <a href="#">RTC_CNTL_WDTCONFIG0_REG</a></li> <li>Modified description of register <a href="#">RTC_CNTL_WDTCONFIGn_REG</a></li> </ul> <p>Changes to Chapter <a href="#">ULP Coprocessor</a>:</p> <ul style="list-style-type: none"> <li>Updated description in sections 30.4.13 and 30.4.14</li> <li>Fixed typos</li> </ul>

Cont'd on next page

## Cont'd from previous page

Date	Version	Release notes
2019.11	V4.1	<p>Changes to Chapter <i>IO_MUX and GPIO Matrix</i>:</p> <ul style="list-style-type: none"> <li>• Updated Table 4-4;</li> <li>• Added field RTCIO_TOUCH_PAD<math>n</math>_FUN_SEL in register RT-CIO_TOUCH_PAD<math>n</math>_REG;</li> </ul> <p>Changes to Chapter <i>SPI</i>:</p> <ul style="list-style-type: none"> <li>• Fixed incorrect SPI2/SPI3 addresses in Table 7.7;</li> </ul> <p>Changes to Chapter <i>I<sup>2</sup>C Controller</i>:</p> <ul style="list-style-type: none"> <li>• Removed I2C_SLAVE_TRAN_COMP_INT interrupt;</li> </ul> <p>Changes to Chapter <i>I<sup>2</sup>S</i>:</p> <ul style="list-style-type: none"> <li>• Added a note under Table 12-1;</li> </ul> <p>Changes to Chapter <i>UART Controllers</i>:</p> <ul style="list-style-type: none"> <li>• Fixed errors in the description of register UART_FORCE_XOFF and UART_FORCE_XON;</li> <li>• Fixed errors in the description of register ART_SWFC_CONF_REG;</li> </ul> <p>Changes to Chapter <i>Remote Control Peripheral</i>:</p> <ul style="list-style-type: none"> <li>• Updated Figure 15-1;</li> </ul> <p>Changes to Chapter <i>PULSE_CNT</i>:</p> <ul style="list-style-type: none"> <li>• Updated Figure 17-1;</li> <li>• Fixed typos in the description of register PCNT_Un_CONF0_REG;</li> </ul> <p>Changes to Chapter <i>eFuse Controller</i>:</p> <ul style="list-style-type: none"> <li>• Added/updated eight system parameters and updated the relevant register description;</li> <li>• Updated the configuration values in Table 20-4;</li> <li>• Modified the bit width of system parameter flash_crypt_cnt to 7 bits;</li> </ul> <p>Changes to Chapter <i>PID/MPU/MMU</i>:</p> <ul style="list-style-type: none"> <li>• Added a note under Table 27-8;</li> </ul> <p>Changes to Chapter <i>On-Chip Sensors and Analog Signal Processing</i>:</p> <ul style="list-style-type: none"> <li>• Fixed typos in the description of registers SENS_SAR2_BIT_WIDTH and SENS_SAR1_BIT_WIDTH;</li> </ul> <p>Changes to Chapter <i>ULP Coprocessor</i>:</p> <ul style="list-style-type: none"> <li>• Corrected the OpCode for REG_WR;</li> <li>• Updated Section 30.6.2.4;</li> <li>• Fixed typos in the description of registers RTC_I2C_RX_LSB_FIRST and RTC_I2C_TX_LSB_FIRST;</li> <li>• Removed the description of registers RTC_I2C_SLAVE_TRAN_COMP_INT_ENA and RTC_I2C_SLAVE_TRAN_COMP_INT_ST;</li> </ul> <p>Changes to Chapter <i>Low-Power Management</i>:</p> <ul style="list-style-type: none"> <li>• Updated the default value and description of register RTC_CNTL_DBROWN_OUT_THRES;</li> <li>• Updated the description of register RTC_CNTL_BROWN_OUT_CLOSE_FLASH_ENA;</li> </ul> <p>Added <a href="#">documentation feedback hyperlink</a>.</p>

Cont'd on next page

## Cont'd from previous page

Date	Version	Release notes
2018.12	V4.0	<p>Updated some register names in Chapter <a href="#">IO_MUX and GPIO Matrix</a> to be consistent with the header files;</p> <p>Changes to Chapter <a href="#">7 SPI</a>:</p> <ul style="list-style-type: none"> <li>• Updated Section <a href="#">7.3</a>;</li> <li>• Updated Section <a href="#">7.5.1</a>;</li> <li>• Updated Section <a href="#">7.8</a>;</li> </ul> <p>Changes to Chapter <a href="#">13 UART Controllers</a>:</p> <ul style="list-style-type: none"> <li>• Removed support for 4 STOP bits;</li> <li>• Added a note at the end of section <a href="#">13.3.2</a>;</li> <li>• Updated the description of register <a href="#">UART_DL0_EN</a>;</li> </ul> <p>Added a note at the end of section <a href="#">31.3.10</a> in Chapter <a href="#">31: Low-Power Management</a>.</p>
2018.10	V3.9	Updated Figure <a href="#">11-3: I<sup>2</sup>C Sequence Chart</a> , in Chapter <a href="#">11: I<sup>2</sup>C Controller</a> .
2018.09	V3.8	<p>Updated the description of register <a href="#">TIMGn_Tx_ALARM_EN</a>;</p> <p>Added description of ULP wakeup time in section <a href="#">30.5: ULP Program Execution</a>.</p>
2018.08	V3.7	Updated the description of register <a href="#">UART_RX_GAP_TOUT</a> .
2018.08	V3.6	<p>Updated the conditions of jumps to relative address in section <a href="#">30.4.6</a>;</p> <p>Updated the description of register <a href="#">UART_ACTIVE_THRESHOLD</a>.</p>
2018.07	V3.5	<p>Changes to chapter <a href="#">15 RMT</a>:</p> <ul style="list-style-type: none"> <li>• Updated RAM start address in section <a href="#">15.2.2: RMT RAM</a>;</li> <li>• Corrected several wrong addresses of RMT registers;</li> <li>• Updated the description of register <a href="#">RMT_APB_CONF_REG</a>.</li> </ul> <p>Updated the description of registers <a href="#">UART_RX_TOUT_THRHD</a>, <a href="#">UART_RXFIFO_FULL_INT_CLR</a>, <a href="#">UART_RXFIFO_FULL_INT_CLR</a>.</p>
2018.06	V3.4	<p>Updated the images in Section <a href="#">4.8: ESP32 I/O Pad Power Supplies</a>;</p> <p>Updated Section <a href="#">11.3.3: I<sup>2</sup>C Bus Timing</a>;</p> <p>Added notes to Section <a href="#">14.2.3: LED_PWM Channels</a>;</p> <p>Updated the "Maximum count value" in Section <a href="#">17.2.3: Pulse Counter Watchpoints</a>;</p> <p>Removed the description of the temperature sensor and LNA.</p>
2018.05	V3.3	Updated the addresses of registers in the <a href="#">Register Summary</a> Section and the <a href="#">Registers</a> Section of Chapter <a href="#">Low-Power Management</a> .
2018.04	V3.2	<p>Updated Figure <a href="#">8-3 CMD53 Content</a>;</p> <p>Added six registers in Chapter <a href="#">Ethernet MAC</a>:</p> <ul style="list-style-type: none"> <li>• <a href="#">DMAOPERATION_MODE_REG</a>;</li> <li>• <a href="#">DMAIN_EN_REG</a>,</li> <li>• <a href="#">DMAMISSEDFR_REG</a>,</li> <li>• <a href="#">PMT_RWUFFR_REG</a>,</li> <li>• <a href="#">PMT_CSR_REG</a>,</li> <li>• <a href="#">EMACLPI_CSR_REG</a>, and</li> <li>• <a href="#">EMACLPTIMERSCONTROL_REG</a>.</li> </ul>

Cont'd on next page

## Cont'd from previous page

Date	Version	Release notes
2018.04	V3.1	Updated Figure 15-1 RMT Architecture; Added a note to Section 4.7; Added the function description for the bits of the register in Section 4.46.
2018.03	V3.0	Updated the instruction layout diagram of ST in Section 30.4.2; Added description of registers EMACADDR2HIGH_REG to EMACADDR7LOW_REG in Section 10.9 and Section 10.10.
2018.02	V2.9	Updated Sections 4.2.2, 4.2.3, 4.3.2; Added registers I2S_FIFO_WR_REG and I2S_FIFO_RD_REG in Section I2S Registers.
2018.01	V2.8	Added Chapter Ethernet MAC. Added the description of system parameter BLK3_part_reserve in Chapter eFuse Controller.
2017.12	V2.7	Added Subsection Cache in Section System and Memory; Updated Section Timers and the naming of several registers in LED_PWM; Updated the description of console_debug_disable in Chapter eFuse Controller.
2017.11	V2.6	Updated Chapter Remote Controller Peripheral: <ul style="list-style-type: none"> <li>• Updated Figure 15-1 RMT Architecture;</li> <li>• Updated section RMT RAM;</li> <li>• Updated section Transmitter;</li> <li>• Updated the description of RMT_CH<sub>n</sub>_TX_THR_EVENT_INT.</li> </ul> Added notes in Section UART RAM and Register UART_CONF0_REG.
2017.11	V2.5	Updated the addresses for register SPI_CTRL_REG in Section SPI Register Summary; Added Section Clock Phase Selection in Chapter SD/MMC Host Controller, and a description of register CLK_EDGE_SEL; Major revision on Chapter I2C Controller.
2017.09	V2.4	Added the description of register SLC0HOST_TOKEN_RDATA in Chapter SDIO Slave; Added notes in Section The Clock of I2S Module; Added a note in Section GP-SPI Master Mode; Added Chapter DPort Register; Added Chapter DMA Controller.
2017.08	V2.3	Added Chapter Flash Encryption/Decryption.
2017.07	V2.2	Added Chapter Low-Power Management.
2017.07	V2.1	Updated the addresses of the GPIO configuration/data registers and the GPIO RTC function configuration registers in Chapter IO_MUX and GPIO Matrix; Added Chapter PID Controller.
2017.07	V2.0	Added Chapter SDIO Slave.
2017.06	V1.9	Updated Chapter IO_MUX and GPIO Matrix; Added Chapter MCPWM.
2017.06	V1.8	Added register I2S_STATE_REG in Chapter I2S; Updated Chapter IO_MUX and GPIO Matrix; Added Chapter ULP Coprocessor.
2017.05	V1.7	Added Chapter On-Chip Sensors and Analog Signal Processing; Added Section Audio PLL; Updated Section eFuse Controller Register Summary;

Cont'd on next page

## Cont'd from previous page

Date	Version	Release notes
		Updated Sections <a href="#">I2S PDM</a> and <a href="#">LCD MODE</a> ; Updated Section: Communication Format Supported by GP-SPI Slave.
2017.03	V1.6	Added Chapter <a href="#">SD/MMC Host Controller</a> ; Added register <a href="#">IO_MUX_PIN_CTRL</a> in Chapter <a href="#">IO_MUX</a> and <a href="#">GPIO Matrix</a> .
2017.03	V1.5	Added Chapter <a href="#">I2S</a> .
2017.01	V1.4	Added Chapter <a href="#">SPI</a> ; Added Chapter <a href="#">UART Controllers</a> .
2016.12	V1.3	Added Chapter <a href="#">eFuse Controller</a> ; Added Chapter <a href="#">RSA Accelerator</a> ; Added Chapter <a href="#">Random Number Generator</a> ; Updated Section <a href="#">I2C Controller Interrupt</a> and Section <a href="#">I2C Controller Registers</a> .
2016.11	V1.2	Added Chapter <a href="#">PID/MPU/MMU</a> ; Updated Section <a href="#">IO_MUX and GPIO Matrix Register Summary</a> ; Updated Section <a href="#">LED_PWM Register Summary</a> .
2016.09	V1.1	Added Chapter <a href="#">I2C Controller</a> .
2016.08	V1.0	Initial release.



[www.espressif.com](http://www.espressif.com)

## Disclaimer and Copyright Notice

Information in this document, including URL references, is subject to change without notice.

ALL THIRD PARTY'S INFORMATION IN THIS DOCUMENT IS PROVIDED AS IS WITH NO WARRANTIES TO ITS AUTHENTICITY AND ACCURACY.

NO WARRANTY IS PROVIDED TO THIS DOCUMENT FOR ITS MERCHANTABILITY, NON-INFRINGEMENT, FITNESS FOR ANY PARTICULAR PURPOSE, NOR DOES ANY WARRANTY OTHERWISE ARISING OUT OF ANY PROPOSAL, SPECIFICATION OR SAMPLE.

All liability, including liability for infringement of any proprietary rights, relating to use of information in this document is disclaimed. No licenses express or implied, by estoppel or otherwise, to any intellectual property rights are granted herein.

The Wi-Fi Alliance Member logo is a trademark of the Wi-Fi Alliance. The Bluetooth logo is a registered trademark of Bluetooth SIG.

All trade names, trademarks and registered trademarks mentioned in this document are property of their respective owners, and are hereby acknowledged.

**Copyright © 2022 Espressif Systems (Shanghai) Co., Ltd. All rights reserved.**